

CHANGE DIMENSIONS AS NEEDED FOR CUSTOM TOWERS

REV. NO.		REVISIONS	DATE	APPROVED

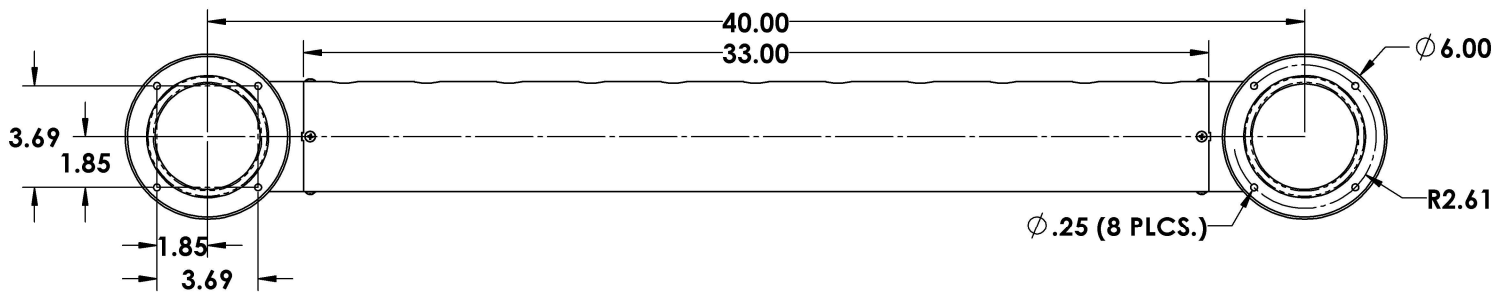
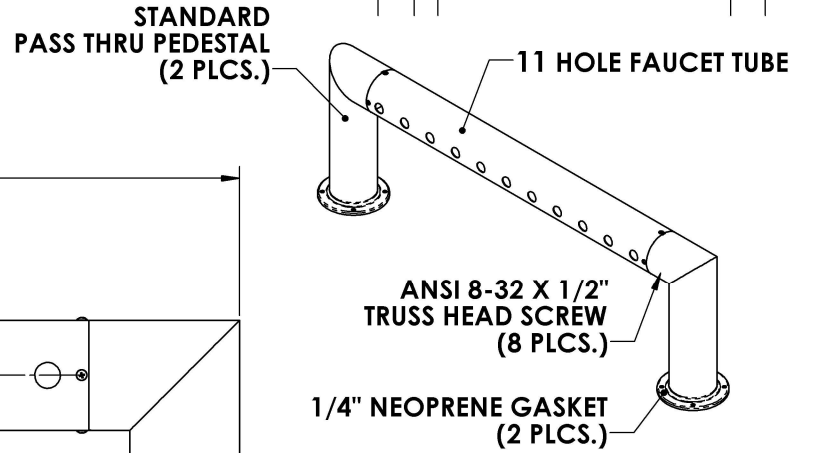
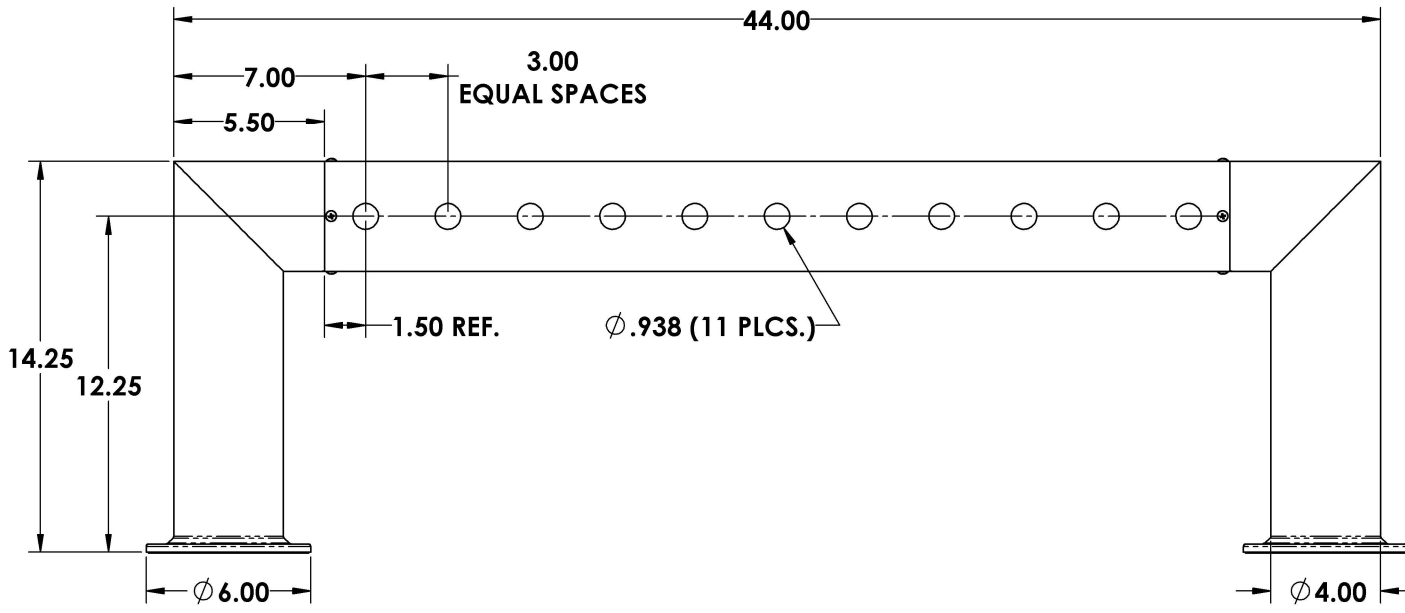

PART # 81024-44

NOTES:
 ALL DIMENSIONS ARE OUTSIDE DIMENSIONS
 (UNLESS OTHERWISE NOTED)

www.acumetalfab.com

PROPRIETARY AND CONFIDENTIAL
 THE INFORMATION CONTAINED IN THIS DRAWING IS THE SOLE PROPERTY OF ACU PRECISION SHEET METAL. ANY REPRODUCTION IN PART OR AS A WHOLE WITHOUT THE WRITTEN PERMISSION OF ACU PRECISION SHEET METAL IS PROHIBITED.
 ACU PRECISION SHEET METAL IS :
 AMERICAN COFFEE URN MANUFACTURING CO., INC

	NAME	DATE
DRAWN	L. WILLIAMS	10/20
MATERIAL	304 STAINLESS STEEL	
FINISH	#8 POLISHED	
REFERENCE	81024-44-11	

TITLE:
4" PASS THRU TOWER 44" PASS THRU ASSEMBLY 11 HOLE
AMERICAN COFFEE URN

DO NOT SCALE DRAWING