

CHANGE DIMENSIONS AS NEEDED FOR CUSTOM T-TOWERS

		REVISIONS			
ZONE	REV.	DESCRIPTION	DATE	APPROVED	

Precision Sheet Metal
 Design ♦ Engineering ♦ Fabrication
 www.acumetalfab.com

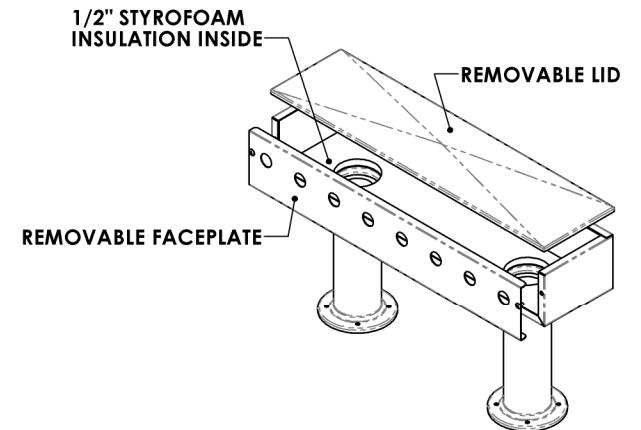
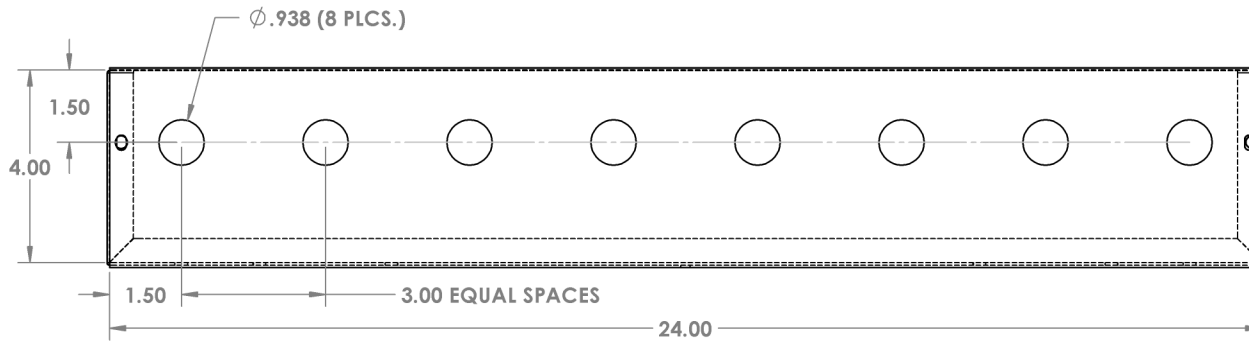
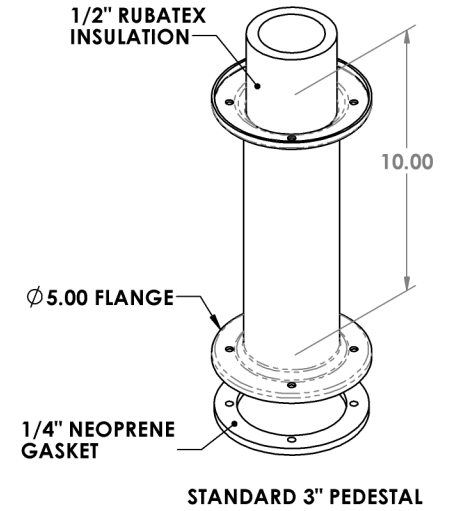
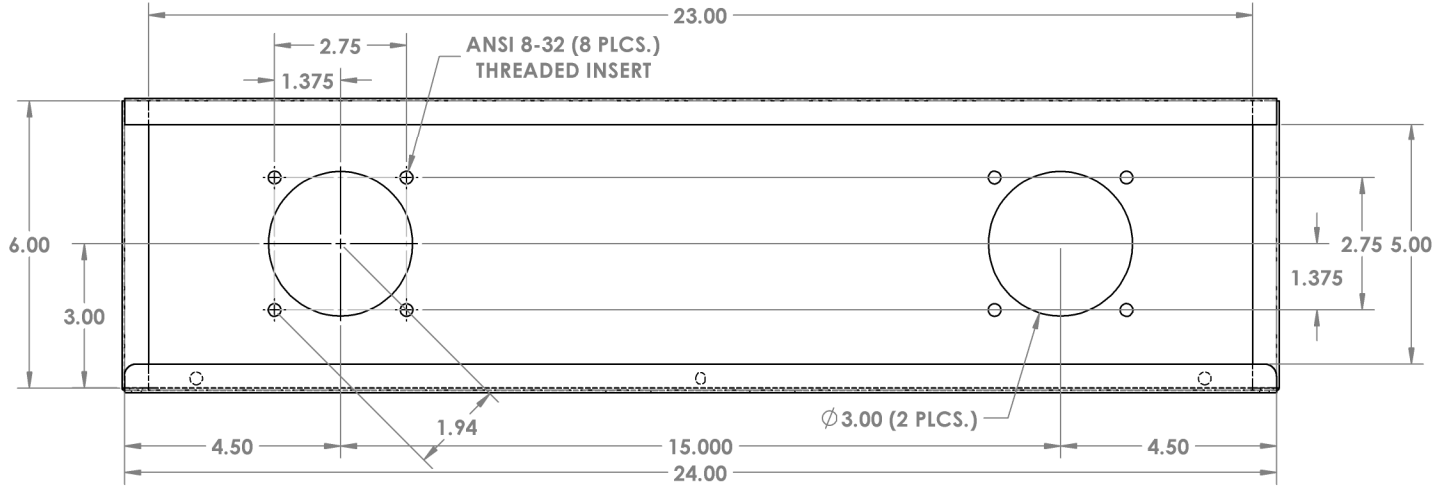

NOTES:

ALL DIMENSIONS ARE INSIDE DIMENSIONS (UNLESS OTHERWISE NOTED)

***FAUCET HARDWARE NOT INCLUDED**

PROPRIETARY AND CONFIDENTIAL

THE INFORMATION CONTAINED IN THIS DRAWING IS THE SOLE PROPERTY OF ACU PRECISION SHEET METAL. ANY REPRODUCTION IN PART OR AS A WHOLE WITHOUT THE WRITTEN PERMISSION OF ACU PRECISION SHEET METAL IS PROHIBITED.

ACU PRECISION SHEET METAL IS :
 AMERICAN COFFEE URN MANUFACTURING CO., INC

	NAME	DATE
DRAWN	L. WILLIAMS	08/16
MATERIAL	16 GA. BRASS	
FINISH	#8 POLISHED	

TITLE:
3" T-TOWER 24" T-TOWER BOX* W/ 8 HOLE FACEPLATE DOUBLE PEDESTAL AMERICAN COFFEE URN