

CHANGE DIMENSIONS AS NEEDED FOR CUSTOM T-TOWERS

REV. NO.		REVISIONS	DATE	APPROVED

Precision Sheet Metal
 Design ♦ Engineering ♦ Fabrication
 www.acumetalfab.com

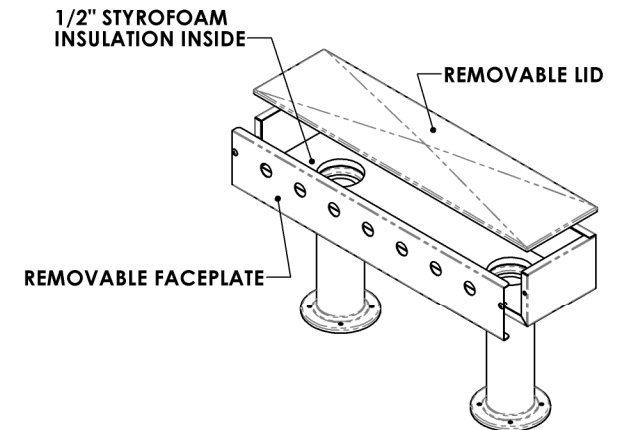
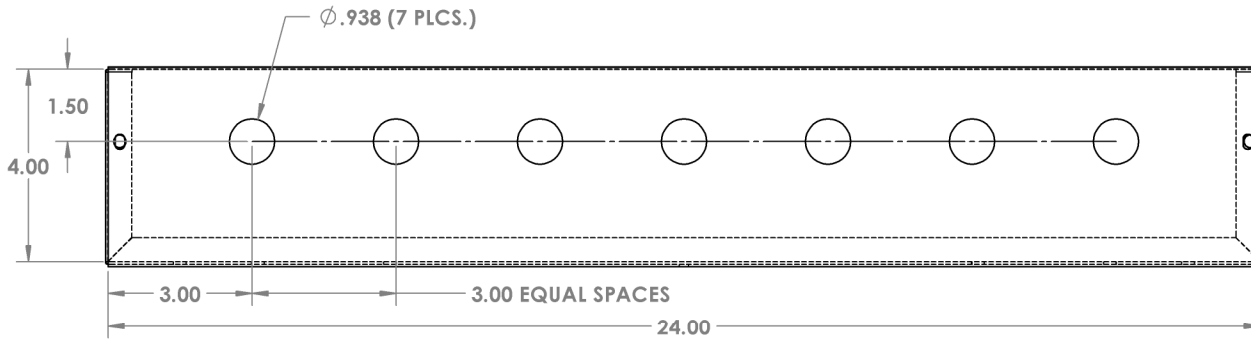
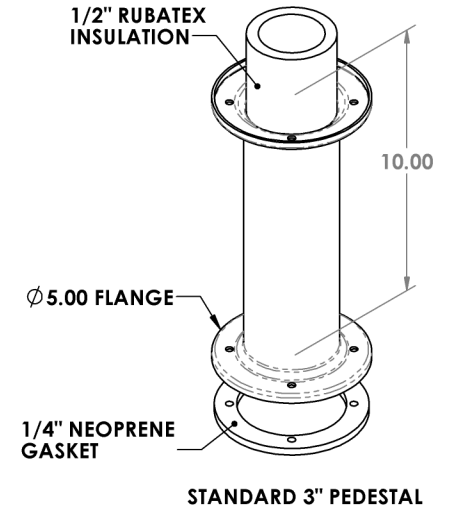
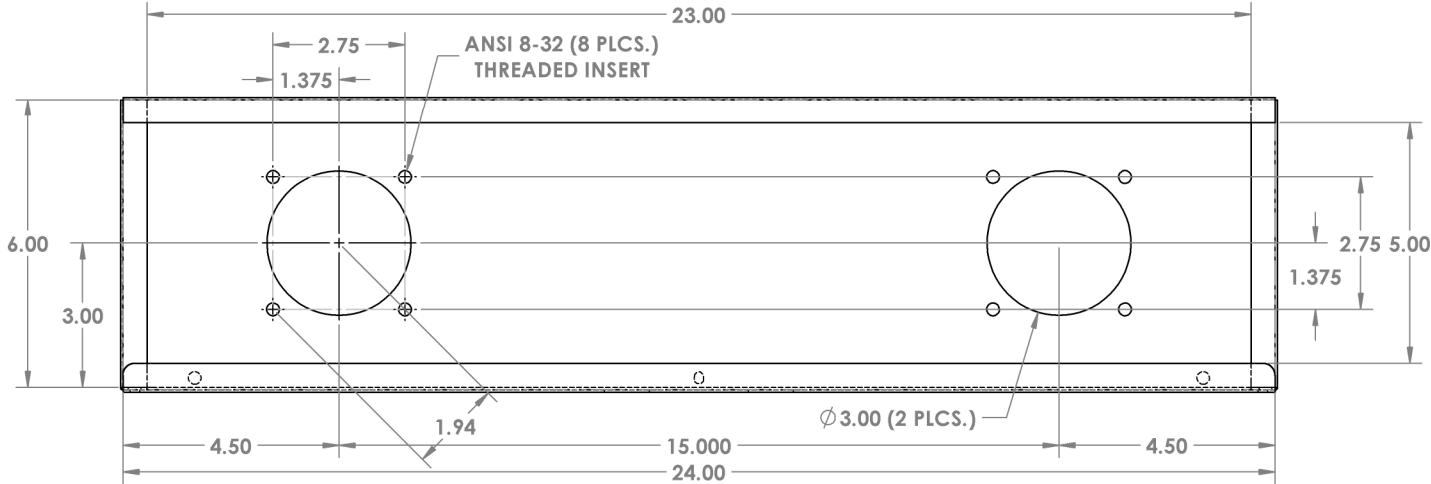

NOTES:

ALL DIMENSIONS ARE INSIDE DIMENSIONS (UNLESS OTHERWISE NOTED)

***FAUCET HARDWARE NOT INCLUDED**

PROPRIETARY AND CONFIDENTIAL

THE INFORMATION CONTAINED IN THIS DRAWING IS THE SOLE PROPERTY OF ACU PRECISION SHEET METAL. ANY REPRODUCTION IN PART OR AS A WHOLE WITHOUT THE WRITTEN PERMISSION OF ACU PRECISION SHEET METAL IS PROHIBITED.

ACU PRECISION SHEET METAL IS : AMERICAN COFFEE URN MANUFACTURING CO., INC

	NAME	DATE
DRAWN	L. WILLIAMS	08/16
MATERIAL	18 GA. 304 STAINLESS STEEL	
FINISH	#8 POLISHED	

TITLE:
3" T-TOWER 24" T-TOWER BOX* W/ 7 HOLE FACEPLATE DOUBLE PEDESTAL AMERICAN COFFEE URN

PART # 1020-24-7Hole-SS8