



Vast selection of TV carts to choose from

Use for Video conference or meetings general purpose at reception or conference room

Find one so specific to your needs, it feels custom-designed

All models feature stable bases for rock-solid support and smooth casters for easy mobility

Options of shelves for keeping laptops, CPUs, VC devices, Cameras

ALUMINIUM FINISH VIDEO CONFERENCE CART

H01



- Movable flat panel tv mount
- With a shelf for VC equipment
- Cable Management inside the pole
- VESA size : 480mm and 680mm
- Support screen upto 30" - 52"
- Product size : 800(W)x600(D)x1250(H)mm
- Support VC equipments up to 5kgs
- Heavy duty wooden base for better support
- Load Bearing : 23 kg
- Colour : Black base

A trendy living-room TV furniture, stylish design with exquisite technique.

Made up of aluminum alloy post, wooden base, tempered safety glass shelf.

Contemporary design with unique combo mechanism, perfect for your valued TV decor.

Hi-end material construction, robust while offering a distinctive look in your living-room.



Adjustable mount to support 30"-52" LCD's



Glass shelf for keeping Video conference base unit or laptop or DVD player



Aluminium body and heavy duty wooden base

UNIVERSAL VIDEOCONFERENCING / PLASMA FLOOR STAND

VCT 01

BLACK



- Movable flat panel tv mount
- With 2 shelves, Lower for VC equipment & upper shelf for camera
- Support LCD upto : 32"-55"
- VESA size : 710*440mm
- Max height : 5 feet from TV center to floor
- Height of TV can be adjustable
- 4 locking Wheels which allows easy movement
- Load Bearing : 35 kg
- Color : Black

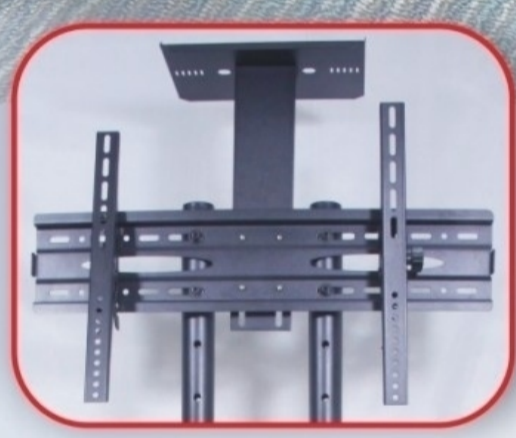

Adjustable mount to support 32" - 55" LCD's & camera shelf

Adjustable Camera shelf interactive meetings and presentation.



Height adjustable lower shelf for VC equipments



4 High grade lockable castors

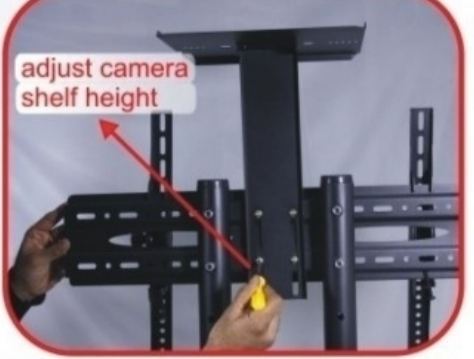

adjust camera shelf height

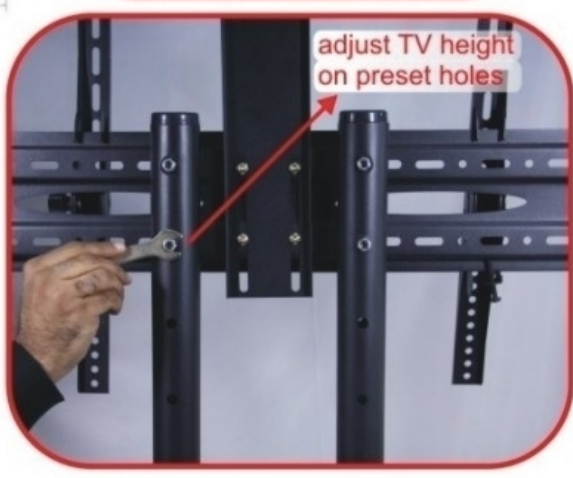
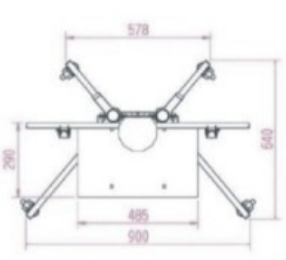
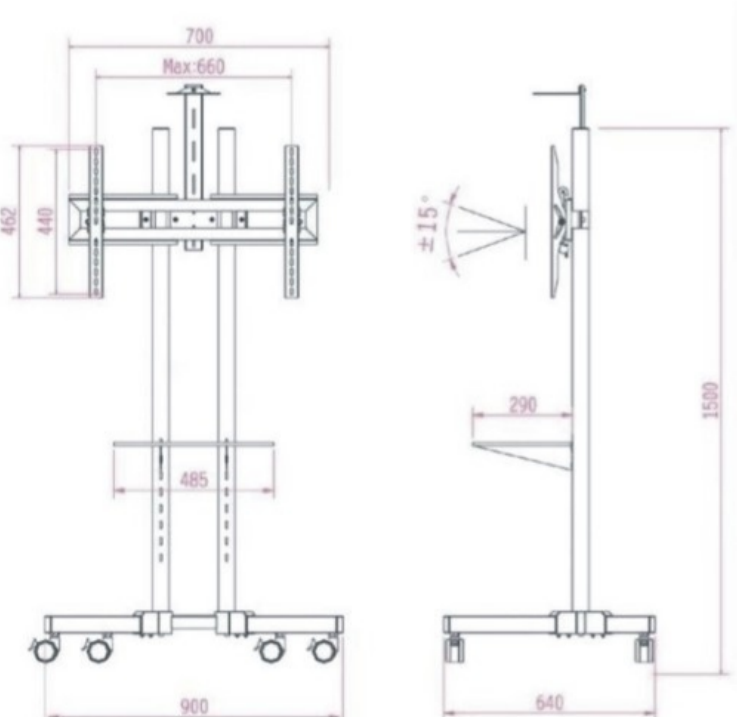

adjust TV height on preset holes

MATCH YOUR ESTHETICS CHOOSE BETWEEN SILVER AND BLACK

SILVER



Adjustable Camera shelf interactive meetings and presentation.

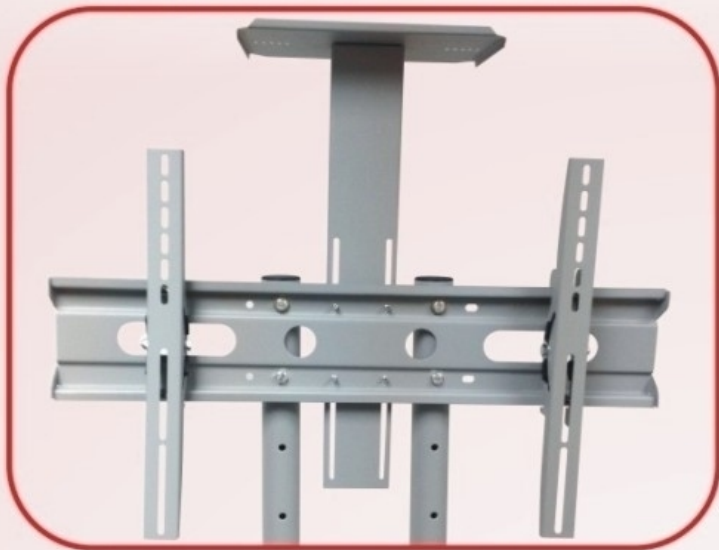

Adjustable mount to support 32" - 55" LCD's & camera shelf



Height adjustable lower shelf for VC equipments



4 High grade lockable castors

Adjust TV height on preset holes

Adjust height of camera shelf

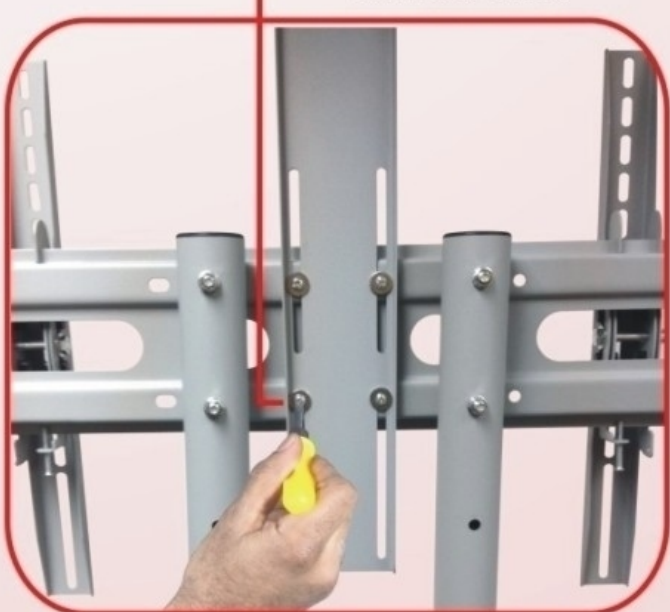
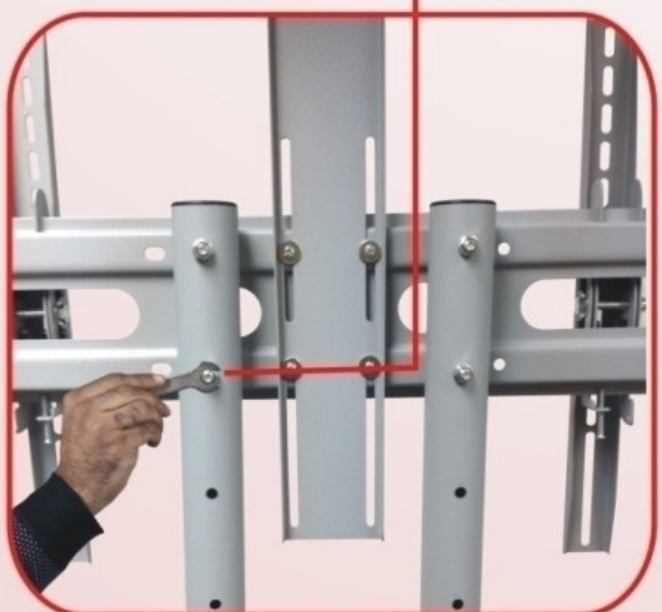

LPC 002

Boardrooms, entrance lobbies, retail displays and many other facilities can be complimented with a plasma displays mounted on the this trolley. Sophisticated innovative stylish media cart. Unit is on four castors and has two shelves for DVD player, VCR, set-top box or Laptop. Post includes cable management. Plasma height can be adjustment as necessary.



LCD PLASMA CART



MOVABLE FLAT PANEL TV MOUNT

5MM TEMPERED GLASS SHELF

SUPPORT LCD UPTO 32"-55"

ADJUSTABLE BRACKET 680mm width, 480mm arms height

MATERIAL Dual Chrome Polished Poles

LOAD BEARING 40 kg

COLOUR Black/Chrome

WEIGHT 21kg/pc



Holes for TV height adjustment



Universal bracket to mount 32" to 55"



Glass shelf for keeping vc base unit or laptop or DVD player



Height Adjustable Shelf



wire can go inside the pole



4 High grade castors with 2 locking



RJT09



Recommended TV Size: 32"-63"
TV back pitch(VESA): MAX 600X400
MM
Distance from the wall: 110-135 CM
Maximum load: 40KG
Up and down to adjust the angle :
 $\pm 12^\circ$
Application area : Homes, schools,
hotels, hospitals, etc.
Material : Iron
Color : Black, white, silver
Gross Weight : 16.5 KG

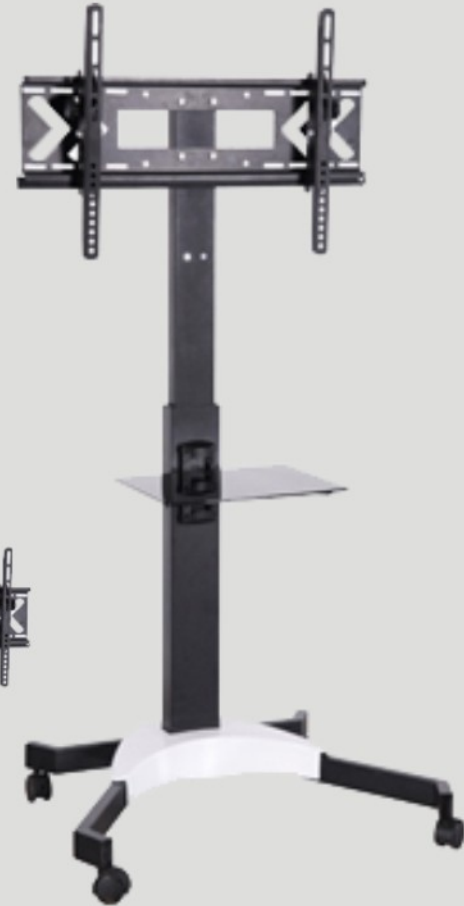

RJTOA



Recommended TV Size: 32"-80"
TV back pitch(VESA): MAX 800X600 MM
Distance from the wall: 155 CM
Maximum load: 50KG
Application area : Homes, schools, hotels,
hospitals, etc.
Material : Quality cold-rolled plate
Color : Black and white silver
Gross Weight : 22.5 KG



Ergonomic Corporation (Hong Kong) Limited.

Office 1:

2nd floor Eton tower 8 ,
Hysen Avenue Causeway, Hongkong.

☎ Tel.: 852-98226451
✉ info@ergohongkong.com
🌐 www.ergohongkong.com

Office 2:

Room no. 28 , block B, 5 floor, Mai Tak Industrial building,
221 wai yip street, kwun tong, kowloon, Hongkong

☎ Tel.: 852-98226451
✉ info@ergohongkong.com
🌐 www.ergohongkong.com