

hinen



SINGLE-PHASE HYBRID INVERTER

H3000-EU/H3600-EU/H4000-EU/H4600-EU/H5000-EU/H6000-EU

Quick Installation Guide

hinen

Dongguan Hinen New Energy Technology Co., Ltd

Add: No.24 Dongkang Road, Dalingshan Town, Dongguan City, Guangdong Province, China

Tel: +86 (769) 8992 0666

Email: market@hinen.com

Website: <https://www.hinen.com>

1. Packing List

Upon receiving the hybrid inverter, please check if any of the components as shown below are missing or broken.

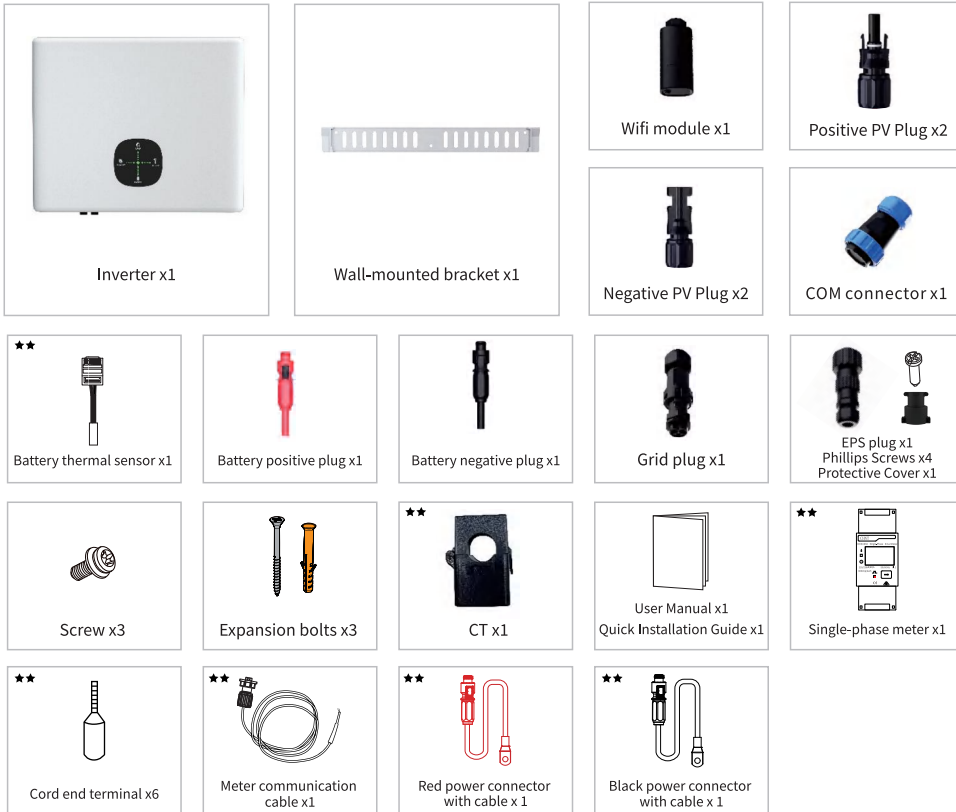

* The images shown here are for reference. The actual product and quantity are based on delivery.

** Optional. Types of equipment to be applied vary in different regions. Please consult local customer service for equipment type selection.

2. Mounting

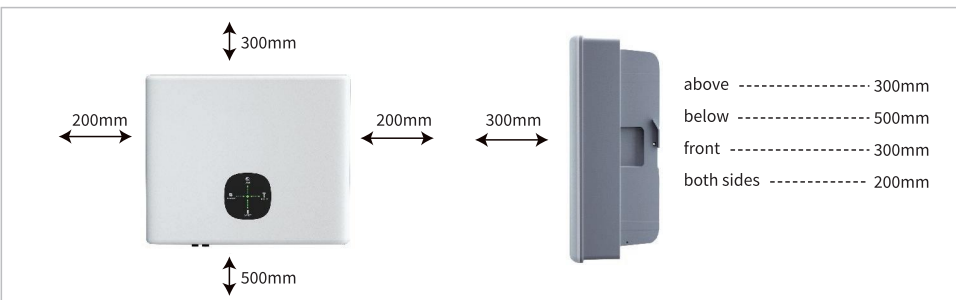

1 Wall mountings are placed horizontally on the installation wall, and making marking points with a marker.

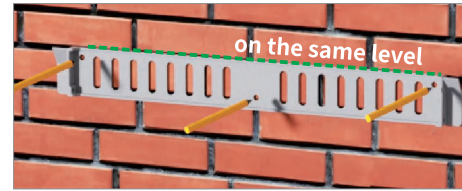

2 Use impact drill to drill holes of 8mm in diameter and 60mm in depth according to the marking points.



3 Put the expansion tube into the wall hole and use the standard self-tapping to lock the wall mountings.

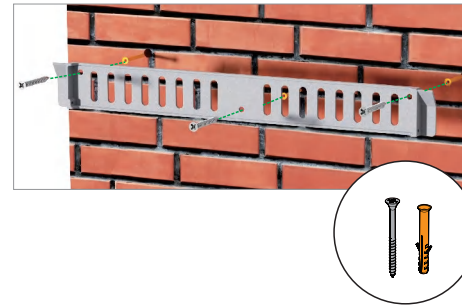

4 Two people are needed to hang the inverter on the wall mountings.

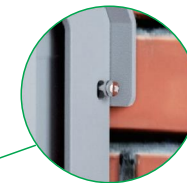

5 Use the standard security screws to lock both sides of the wall mountings.

Cable connection for the PE end:

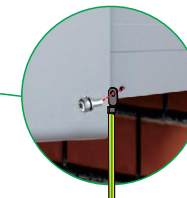

6 Connect the PE cable to the grounding plate at the grid side.

System Connection Diagrams

Note: According to Australian safety requirements, the neutral cables of the on-grid side and backup side must be connected together. Otherwise, the backup function would not work.

This diagram is an example for an application that neutral connects with the PE in a distribution box (with smart meter). For countries such as Australia, New Zealand, South Africa, etc., please follow local wiring regulations!

This diagram is an example for an application that neutral connects with the PE in a distribution box (with CT). For countries such as Australia, New Zealand, South Africa, etc., please follow local wiring regulations!

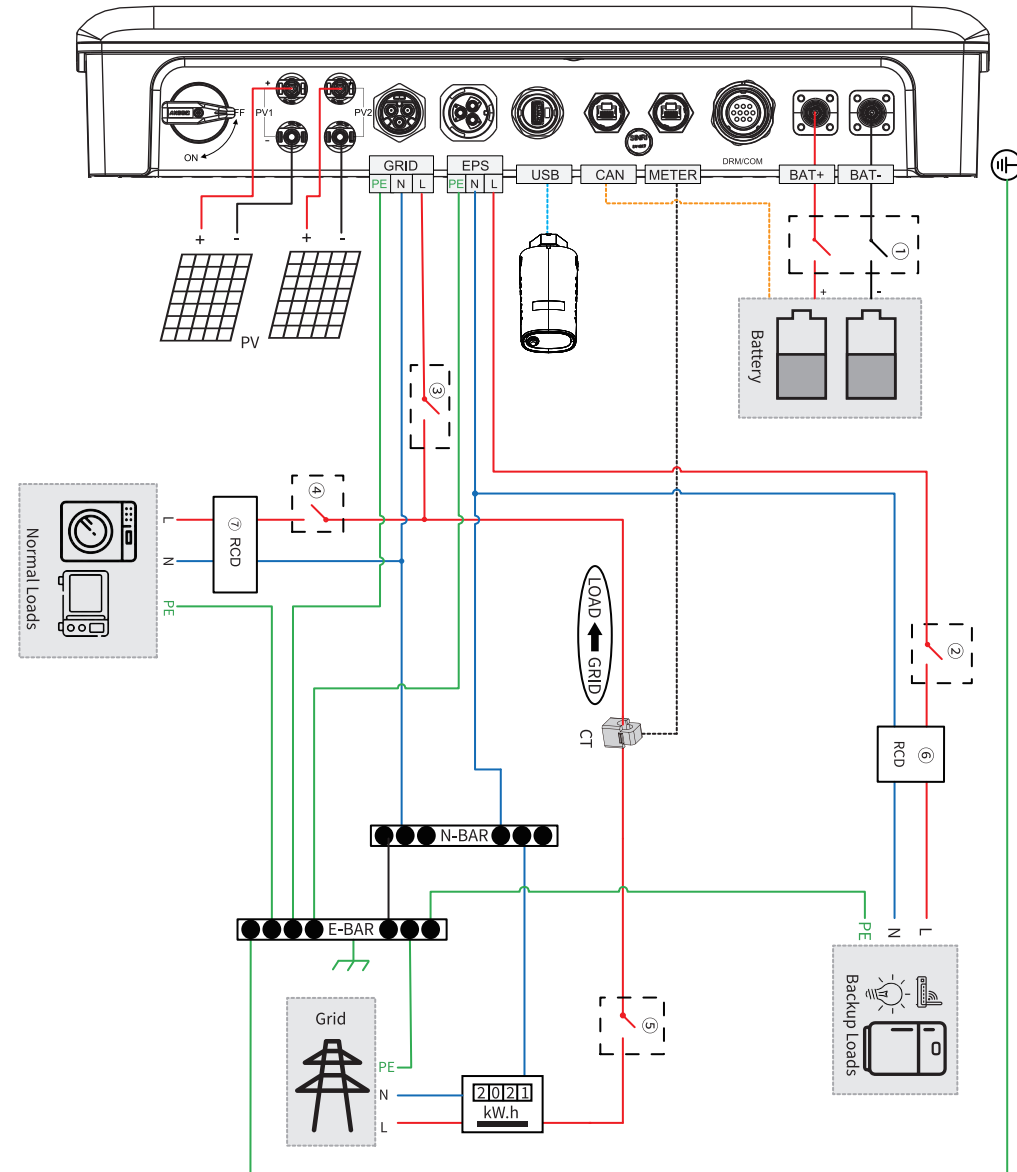
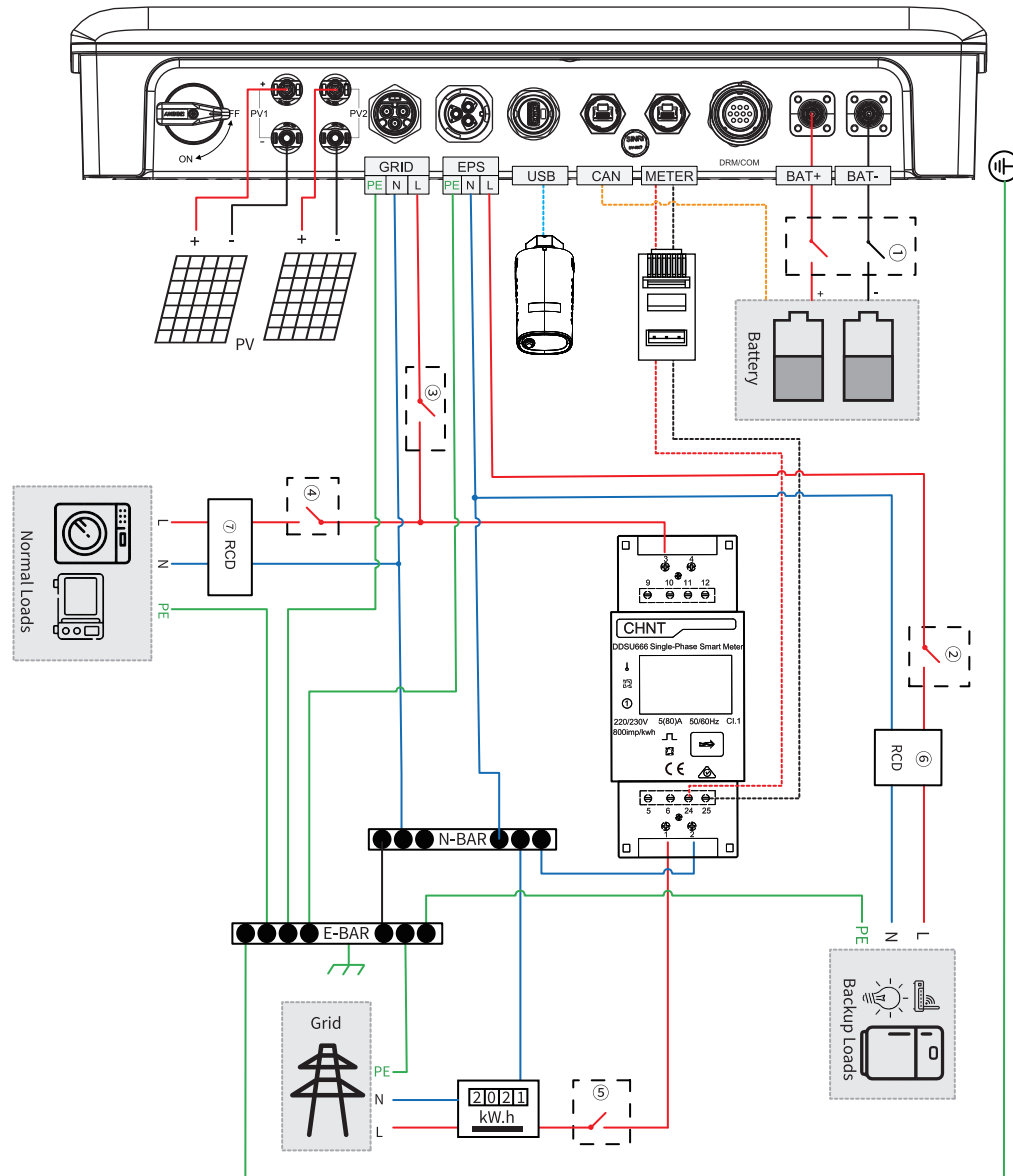

This diagram is an example for grid systems without special requirements on electrical wiring connection (with smart meter).

Note: The back-up PE line and earthing bar must be grounded properly and effectively. Otherwise the back-up function may be abnormal when the grid fails.

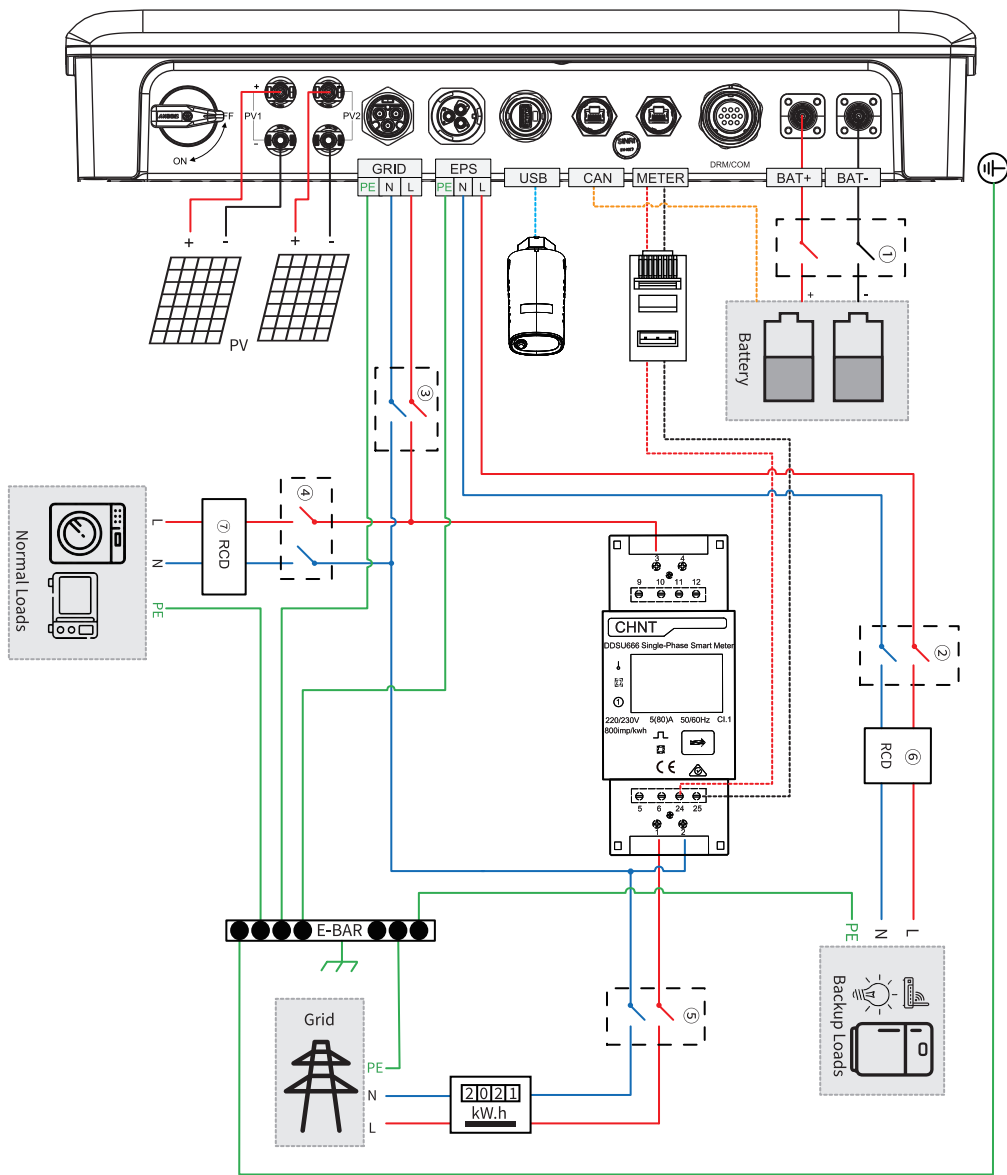

This diagram is an example for grid systems without special requirements on electrical wiring connection (with CT).

Note: The back-up PE line and earthing bar must be grounded properly and effectively. Otherwise the back-up function may be abnormal when the grid fails.

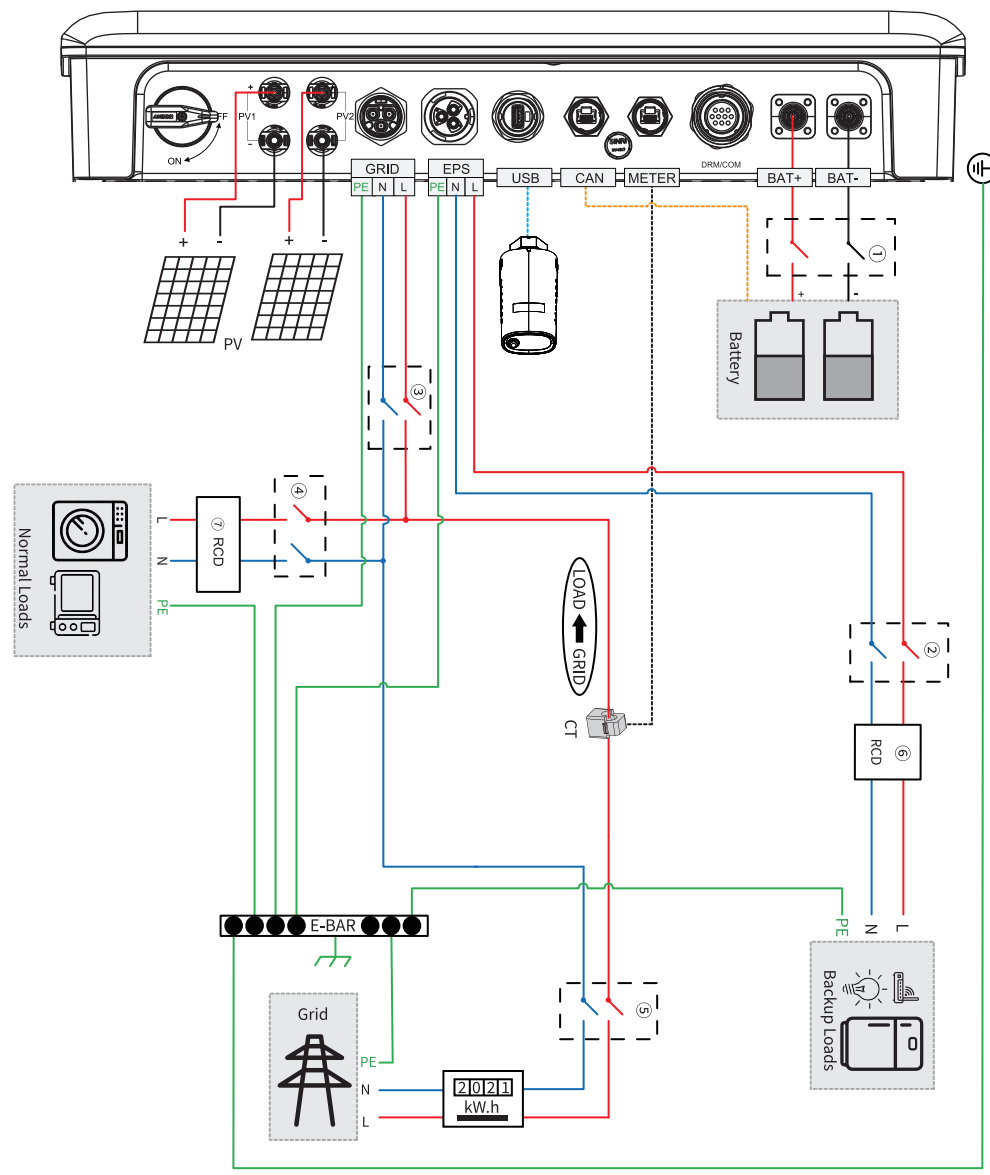

Model	①	②	③	④	⑤	⑥	⑦
	H3000-EU	20A/230V AC Breaker	40A/230V AC Breaker	Depends on Loads	Main Breaker	40A/230V 30mA RCD (Type A)	63A/230V 30mA RCD (Type A)
	H3600-EU	20A/230V AC Breaker	40A/230V AC Breaker				
	H4000-EU	25A/230V AC Breaker	40A/230V AC Breaker				
	H4600-EU	32A/230V AC Breaker	40A/230V AC Breaker				
	H5000-EU	40A/230V AC Breaker	63A/230V AC Breaker				
	H6000-EU	40A/230V AC Breaker	63A/230V AC Breaker				
180A/100V DC Breaker		180A/100V DC Breaker					

Note

- If the battery has integrated a readily accessible internal DC breaker, then no additional ① DC breaker is required.
- The use of ⑥ ⑦ 30mA RCD is recommended but not mandatory, please comply with local regulations for the system installation.

3. Electrical Connection

Step 1 Grounding Protection Wire

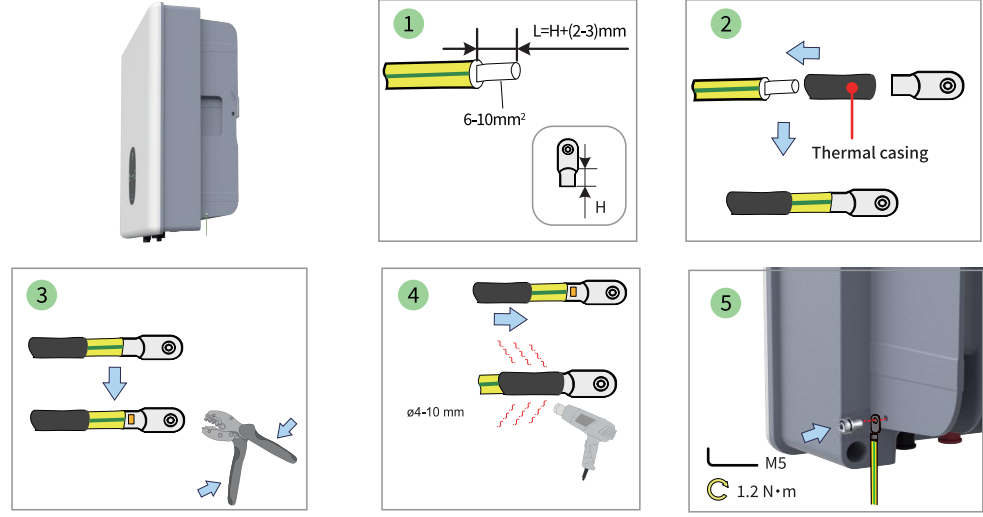

Step 2 Grid

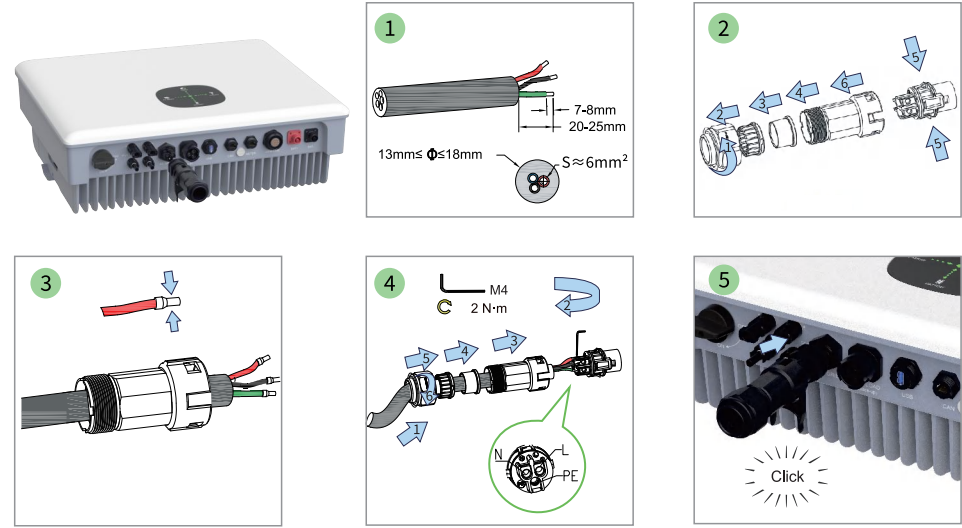

Remove the Grid plug

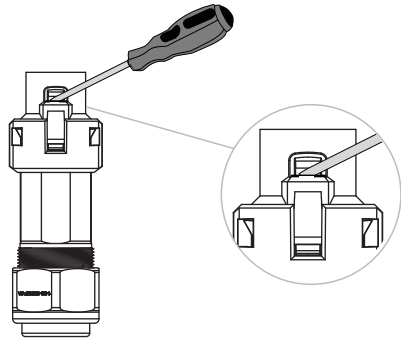

Warning: Disconnect power from grid and equipment, and remove grid terminals by professional installer.

• After the AC Grid is installed, a protective cover must be added.

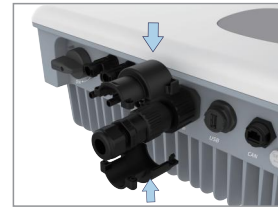

Remove the EPS plug

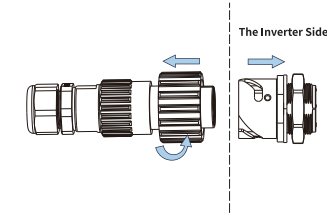
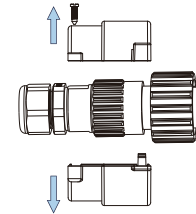

Step 3 EPS

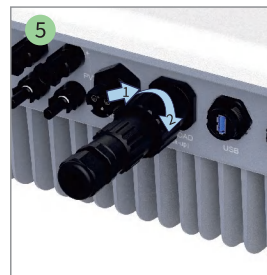
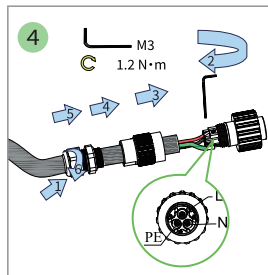
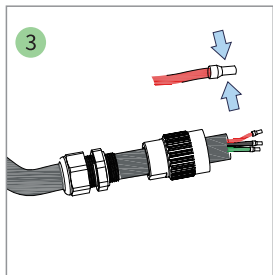
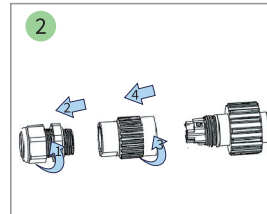
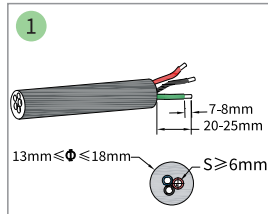

Step 4 PV

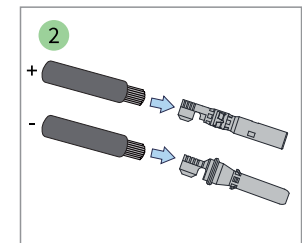
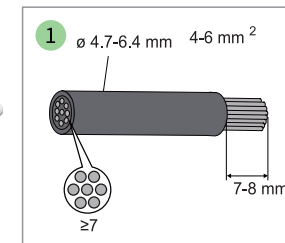

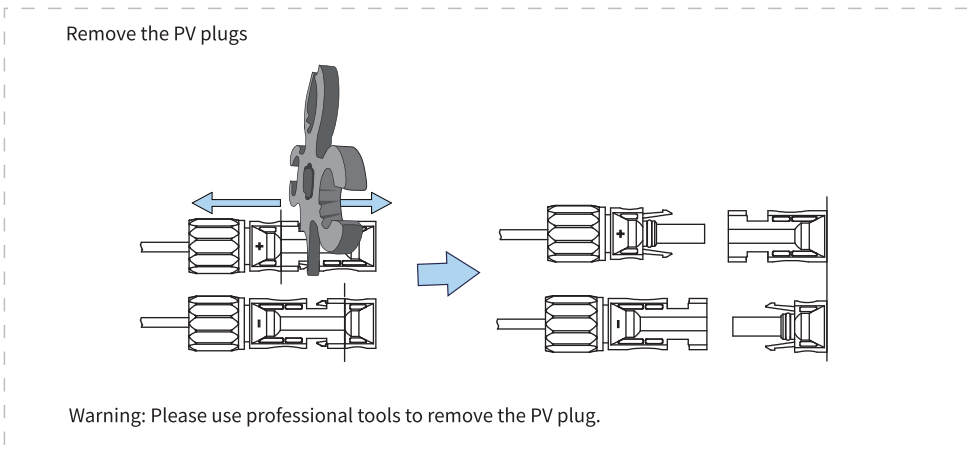
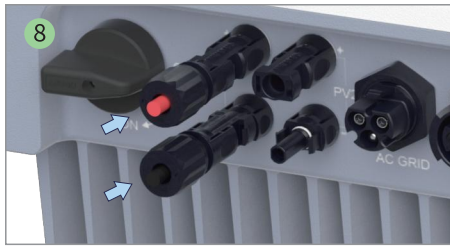
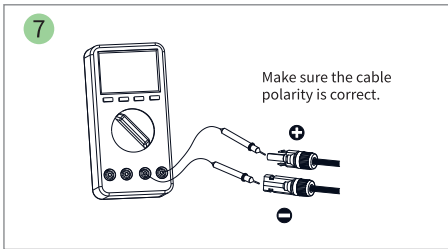
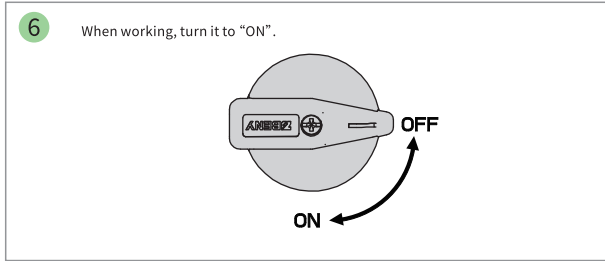
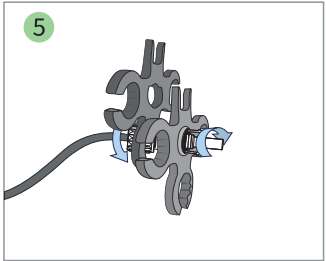
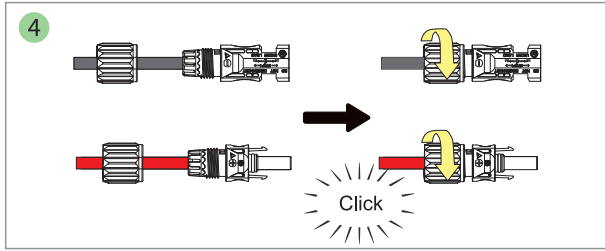
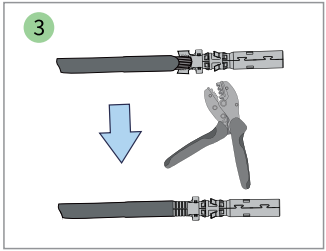

Step 5 Battery

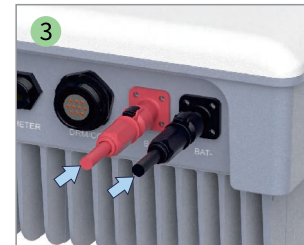
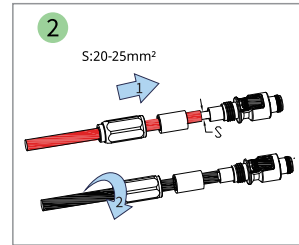
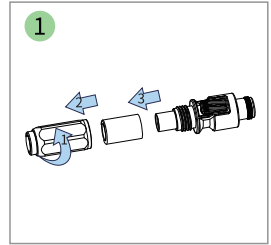

Step 6. COM Connection Mode



1	COM/DRM0
2	REFGEN
3	DRM4/8
4	DRM3/7
5	DRM2/6
6	DRM1/5
7	485-B
8	485-A
9	RLY_+12V (Dry contact positive)
10	RLY (Negative dry contact)

1. Route the signal cable through the terminal protection cover, as shown in the figure.
2. Insert the signal cable into the wiring hole and tighten it with Phillips screwdriver.
3. Install and lock the parts of the connector according to the figure.

Internal wiring diagram of COM connector:

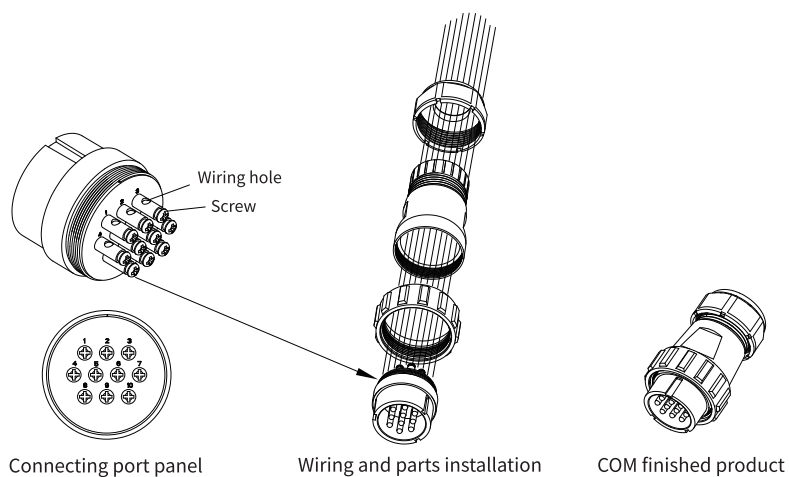

The CAN port connects to the BMS

The METER port connects to a smart electricity meter or current transformer

Step 8. WiFi Module Connection

The Wi-Fi communication function is only applied to WiFi Module.

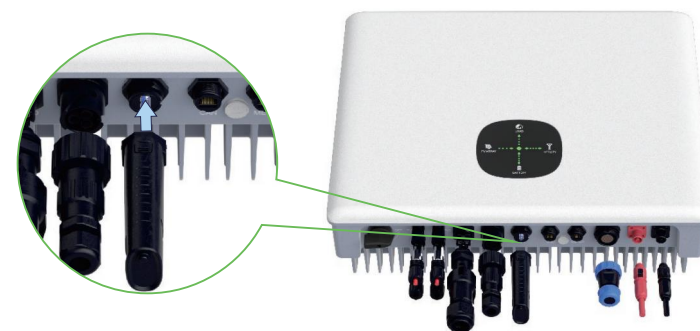

Step 7. CT (Current Connections) and BMS

The inverter BMS Port/Smart Meter/CT Detailed pin function.

Pin	Color	CAN(BMS)	METER (Smart Meter)	CT
1	Orange and white	WAKE_UP	485_B	NC
2	Orange	GND	NC	IGRID_LOADN
3	Green and white	NC	NC	NC
4	Blue	CANH	NC	NC
5	Blue and white	CANL	485_A	NC
6	Green	NC	NC	NC
7	Brown and white	NC	NC	NC
8	Brown	NC	NC	IGRID_LOADP

4. Online Setting

SOLARMAN Smart APP is an on-line monitoring system for users to use and SOLARMAN Business APP is for installers to use. After completing the communication connection, please visit www.solarman.cn or download the APP by scanning the QR code to monitor your photovoltaic power station and equipment.

