

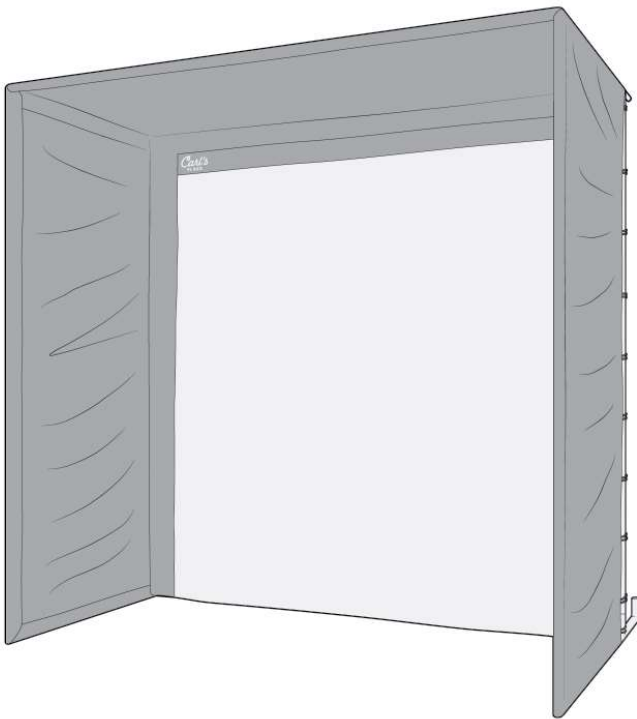

DIY Enclosure Kit

Assembly Instructions & User Manual



Get it digitally.



Thank you for purchasing a golf simulator impact screen and enclosure kit from Carl's Place! In this guide you will find everything you need to complete your kit assembly, plus a few tips to help you make the best use of it.

Materials List

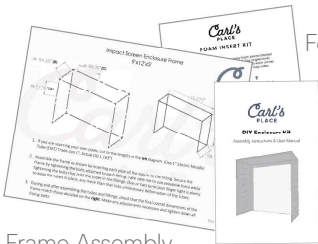

Foam Layout Sheet

Manual

Frame Assembly Sheet



Ball bungees

Releasable zip ties

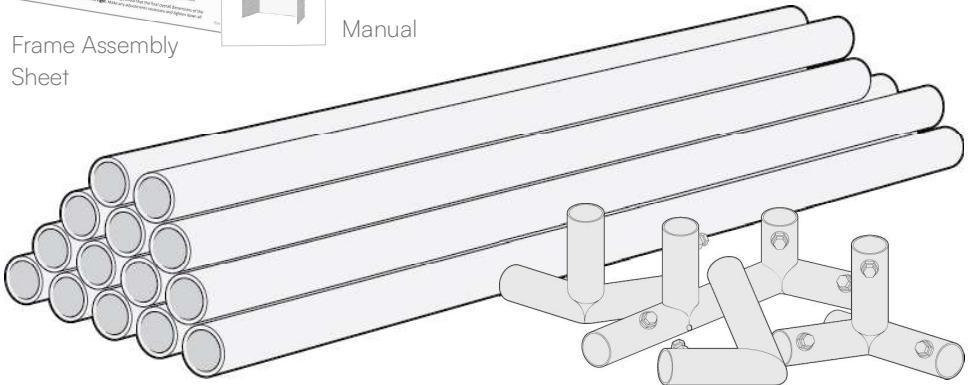

(1) Kit of pre-cut and marked pipes OR self-sourced, if pipes were not purchased

(1) Kit of pipe connector fittings

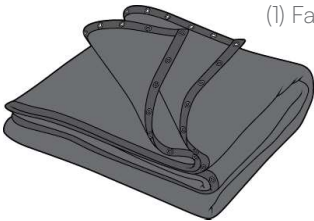

(1) Fabric enclosure cover

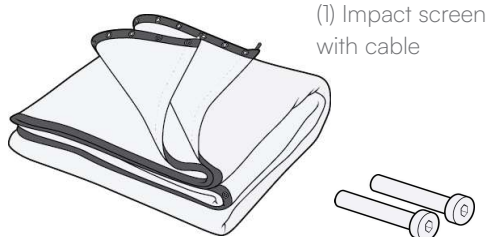

(1) Impact screen with cable

(2) Cable receivers

Optional Accessories

- Foam Inserts
- Ceiling Baffle(s)
- Back Cover

Assembly Overview

Tools Needed

- Wrench or 1/2" socket
- 3/16" Hex key
- Rubber mallet
- Pliers
- Cutting tool
- Step Ladder (8-ft recommended)
- Optional. A friend who owes you a favor

1. Assemble Frame

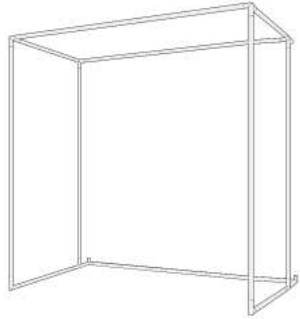

2. Hang Enclosure Cover

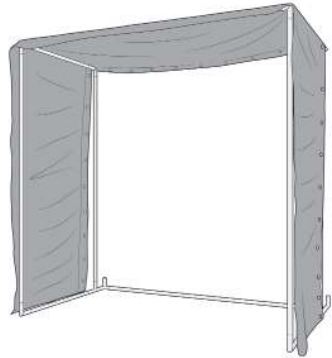

3. Attach Impact Screen

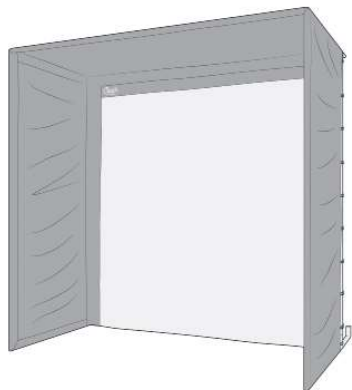

Assemble Frame

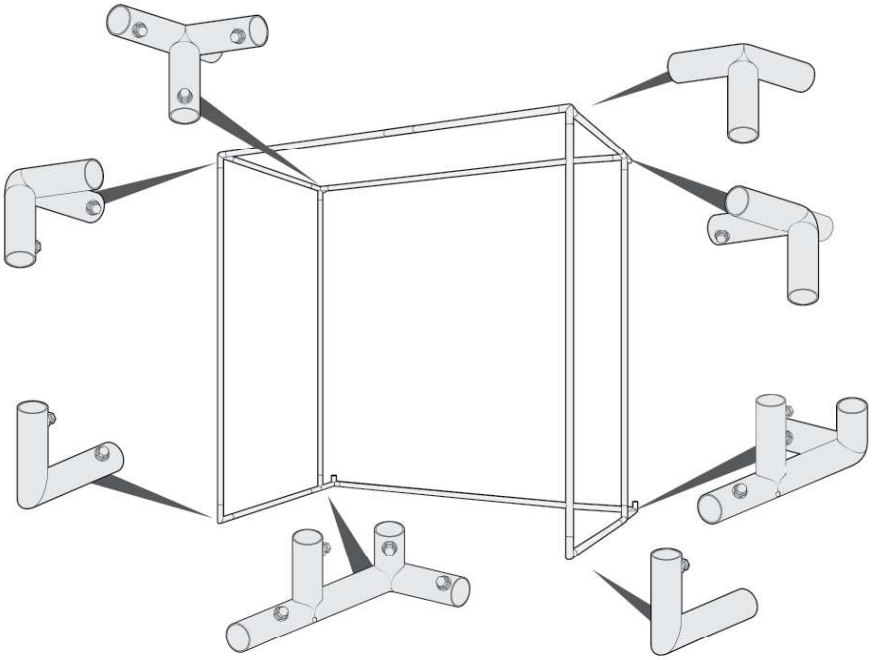

Using the Frame Assembly Sheet included with this enclosure, construct your frame.

If you bought a pipe kit from Carl's Place, simply insert the pipes fully into the connectors and tighten using a wrench or $\frac{1}{2}$ " socket.

Notice extra holes in your pipes? If you bought pipes from us, you may notice some small holes in the pipes. Disregard them, they are just part of the manufacturing process.

If you did not buy a pipe kit from Carl's Place, you must source your own pipes, cut to the specifications shown on the Frame Assembly Sheet.

Carl's Tips

Start by putting together the bottom base of the frame. If necessary, use a rubber mallet to completely insert the pipes into the fittings. Then, work bottom to top, back to front.

Hang Enclosure Cover

Before attaching the cover, orient the cover so that:

1. The grommeted edges are toward the back of the frame.
2. The front of the panel has a flap that hangs over the front pipe.
3. The flaps with hook-and-loop fasteners face the inside of the enclosure.

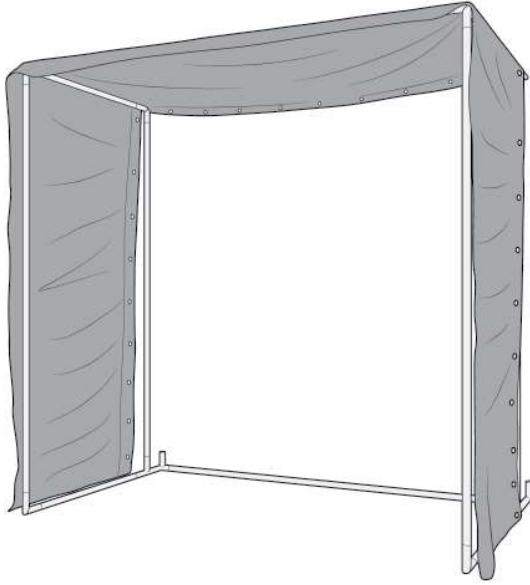

Place the fabric enclosure cover over the top of the completed frame.



Attach Inside Corner Flaps

Unfold the two flaps on the upper inside corners of the enclosure cover (the flaps run the depth of the cover).

Using the hook-and-loop fastener strips, cover the two upper pipes connecting the front and back of the frame.

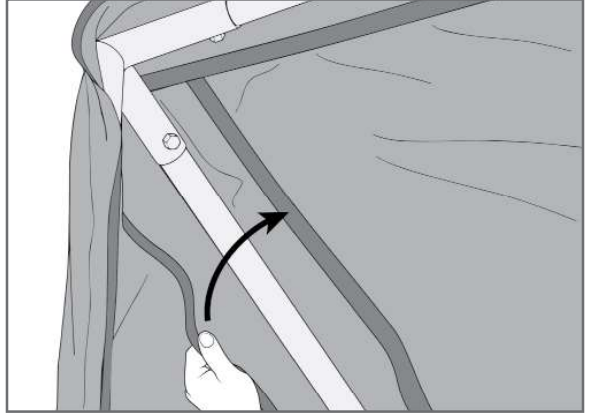

Attach Bottom Flaps

On each side of the enclosure, wrap the enclosure cover under the bottom of the frame.

Attach to the side of the enclosure using the hook-and-loop fasteners.

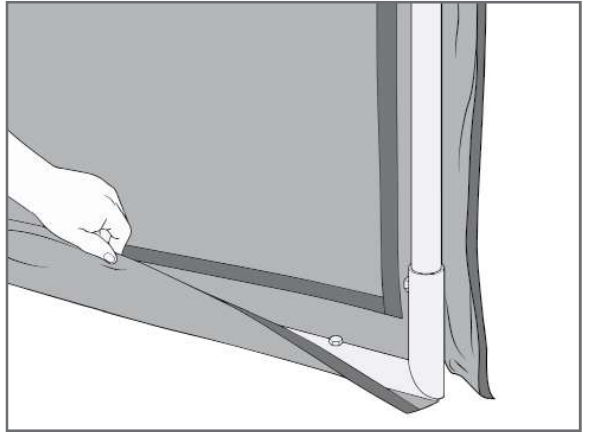

Carl's Tips

Raise up the enclosure frame by setting it on some wood blocks. It will be easier to wrap the cover around the bottom.

Attach Side Flaps

On the side flap, attach the hook fasteners to the closest loop strip. This leaves the rear loop strip accessible.

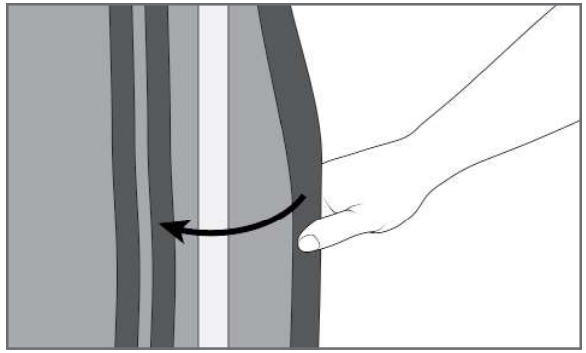

Attach Top Flaps

Repeat the process with the flaps on the top of the enclosure.

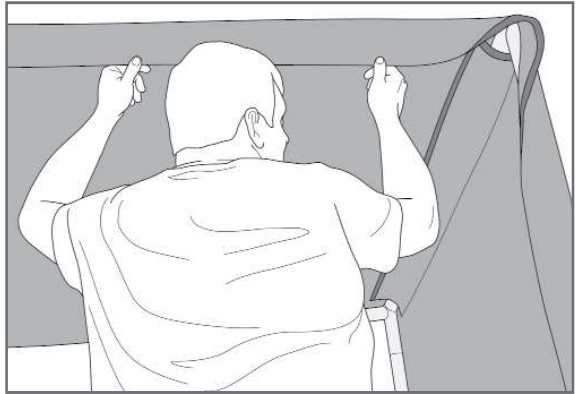

At the corners, excess material should be folded in on itself to keep it from hanging free.

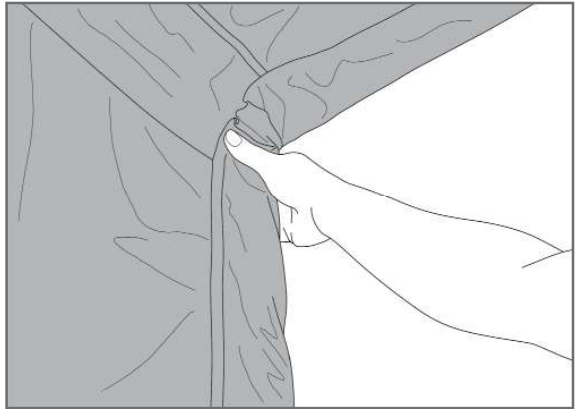

Attach Cover with Ball Bungees

Attach the enclosure cover to the frame using included ball bungees. Face the ball of the bungee to the back of the enclosure.

Using Ball Bungees:

1. Insert the loop end of the bungee into a grommet.
2. Thread it through until the ball stops it.
3. Wrap the loop end around the pipe.
4. Hook it over the ball to secure.

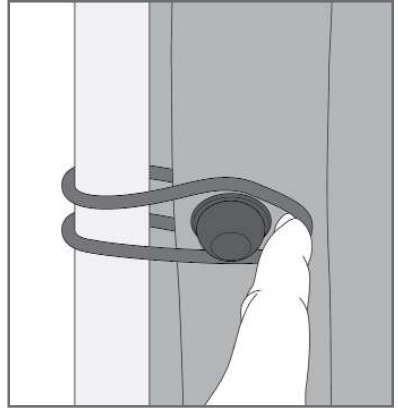

Carl's Tips

While installing bungees, check over your work. Is the fabric even and smooth? It's easier to make adjustments before the fabric is pulled taut.

Install (Optional) Baffles

Pull back the fabric flap at the top of the enclosure to attach a baffle.

Baffles can be spaced at any preferred distance away from the screen. 1 - 1.5 ft apart is common.

Hang the baffle(s) with bungees around the top pipes on each side of the enclosure, with the matte side facing the front.

Zip-ties can be used to apply extra tension if needed.

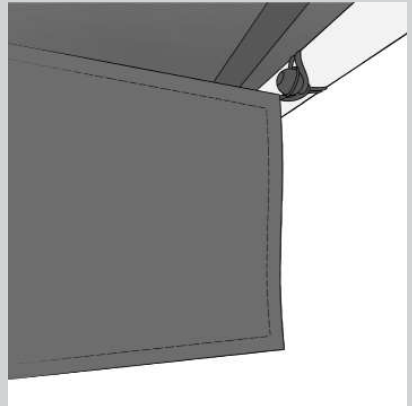

Congrats! You've got your golf enclosure up! On to the impact screen.

Attach the Impact Screen

Orient the impact screen with the Carl's Place logo in the top left.

Attach the impact screen to the frame, beginning with 2 ball bungees in each of the **top corners**. Face the ball of the bungee to the back.



Simplified to show detail. Actual impact screen has flaps.

Next, you'll attach the bottom of the impact screen using the cable. The cable is pre-threaded through the bottom sleeve of the impact screen.

On one of the rear corner fittings, locate the small hole at the base of the fitting.

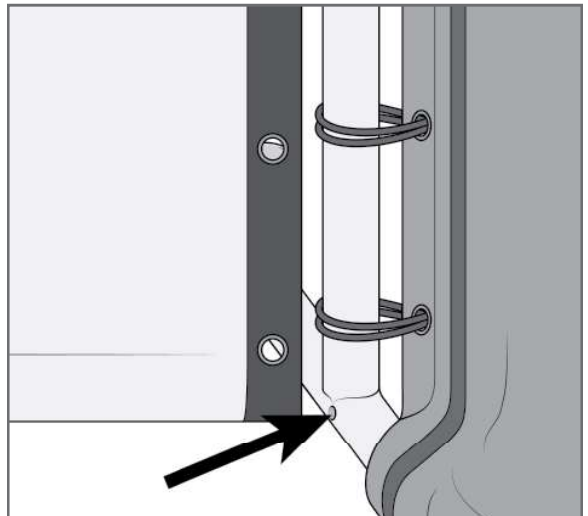

On one side, insert the cable through the fitting. Secure the cable with 4 turns of the cable receiver. Repeat on the other side.

Carl's Tips

You may need to loosen the first receiver if you can't get the second receiver threaded.

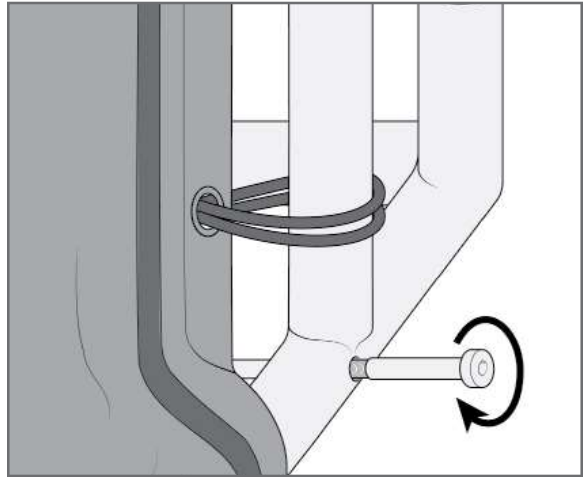

Continue tightening each end of the cable, until the cable is taut. Use a pliers to hold the cable and prevent it from spinning, while using $\frac{3}{16}$ " Hex key to tighten the receiver.

Do not overtighten.

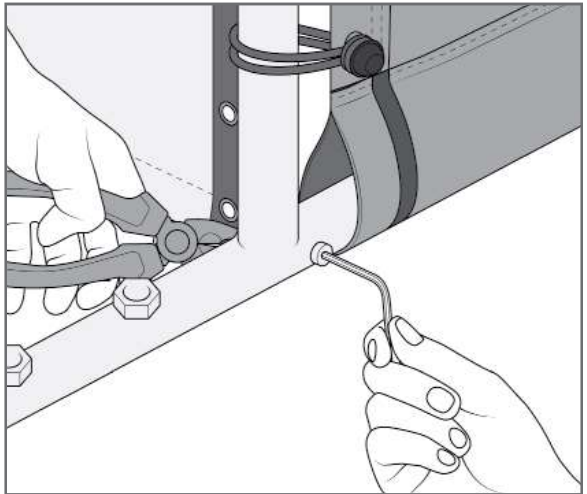

Secure each of the bottom grommets of the screen with a zip tie. Wrap the zip tie under and around the bottom pipe, held in place by the exposed receiver end.

These 2 bottom zip ties can be pulled tight.

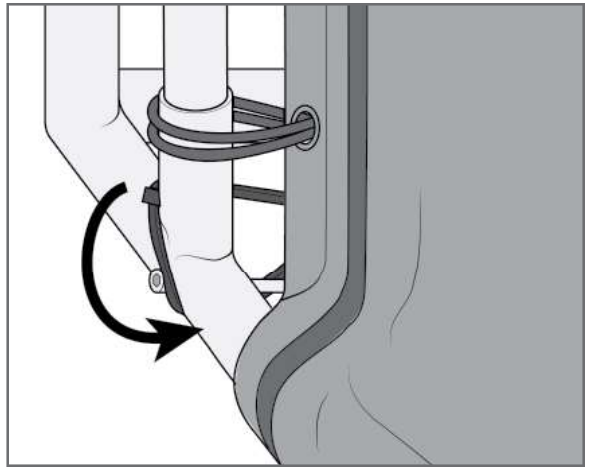

Add zip ties to the remaining grommets, tightening only enough to maintain an even gap between the screen and the pipe.

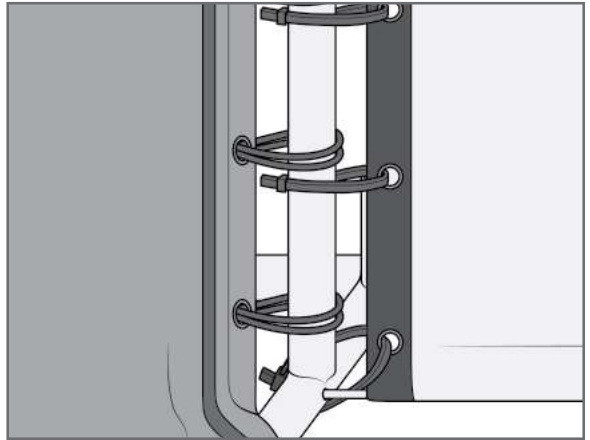

Check the spacing. The bottom of the screen should be level with the floor.

Screen lifting off the floor?
Adjust zip ties to obtain minimal gap on the floor. Don't forget the sides, you may have too much tension on one of the zip ties attached to the vertical pipes.

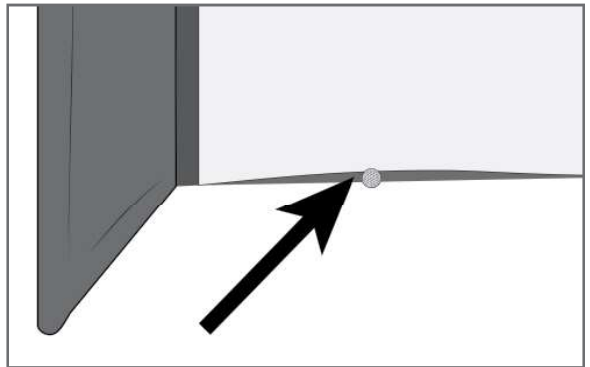

Carl's Tips

If the screen rests on high pile carpet, you might find an increased number of golf balls making their way under the screen. To keep the balls from rolling away, consider adding a back cover.

Insert (Optional) Foam Inserts

If ordered, you'll receive enough foam inserts to cover the sides and top of your enclosure frame. Starting at the bottom, push foam inserts into the corners of your enclosure, between the enclosure and the screen.

Cover each piece of foam with the screen flap and secure the flap with the hook and loop strips.

The foam will be snug to prevent ricochets. It's helpful to have 2 people. One to push the foam in. One to secure the flap.

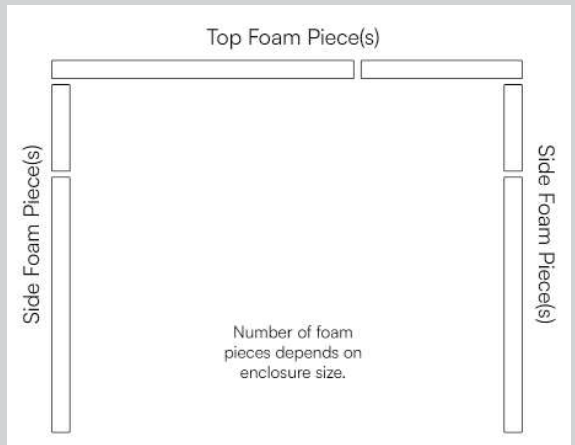
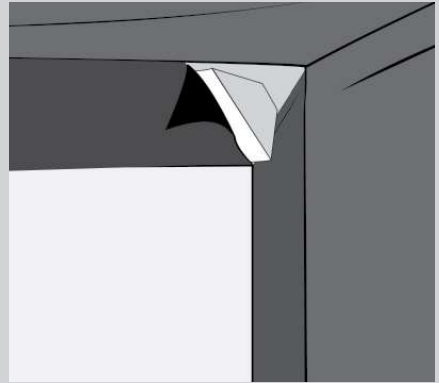

Attach Side and Top Screen Flaps

Working around the sides and top of the screen, cover the remaining visible frame pipes using the flaps attached to the screen. Fold the flaps over the grommeted edges of the screen and attach to the enclosure cover using the installed hook-and-loop strips.



Attach Net Walls

If ordered, your net walls attach to the loop strip still exposed on the front of the enclosure cover.

Not seeing a loop strip? Return to Step [Attach Side Flaps](#).

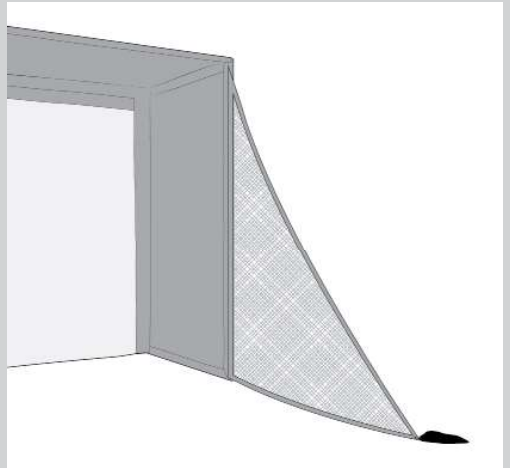

Install Back Cover

If ordered, you'll receive further instructions on incorporating your back enclosure cover into your enclosure assembly.

Nip, tuck, and straighten out any bumpy edges. [You're ready to golf!](#)

Hopefully that was the easiest assembly you've done of any floor to ceiling structure. Our enclosure kits are designed with customer feedback in mind to make easy to assemble, easy to use, easy to practice golf simulators.

Send Carl a Picture!

We want to see your golf setup! Scan the QR code or go to www.carlofet.com/share-with-us. Send us pics. Videos. Rave reviews. Or even recommendations.



More of a social creature?

Tag us and throw a quick #mycarlsplace on your post.

We just may feature your golf simulator in our next campaign.

Anything else we can help you with?



info@carlofet.com



(608) 352-0002, Monday-Friday, 8am-4pm CT

Customers who do not follow the assembly, instructions and tips in this manual increase their risk of injury. Take proper safety precautions to protect ceilings, walls, windows, cars and neighboring homes. Keep children, pets and spectators out of swing range. **By using any Carl's Place product(s), you agree to the Terms and Conditions, as well as the Privacy Policy and any policies referenced on www.carlofet.com.**

Thank you for your business!

Carl's Place LLC, 1650 Putman Pkwy, Milton, WI 53563

Questions? Comments? We welcome your feedback!

www.carlofet.com | info@carlofet.com | (608) 352-0002