

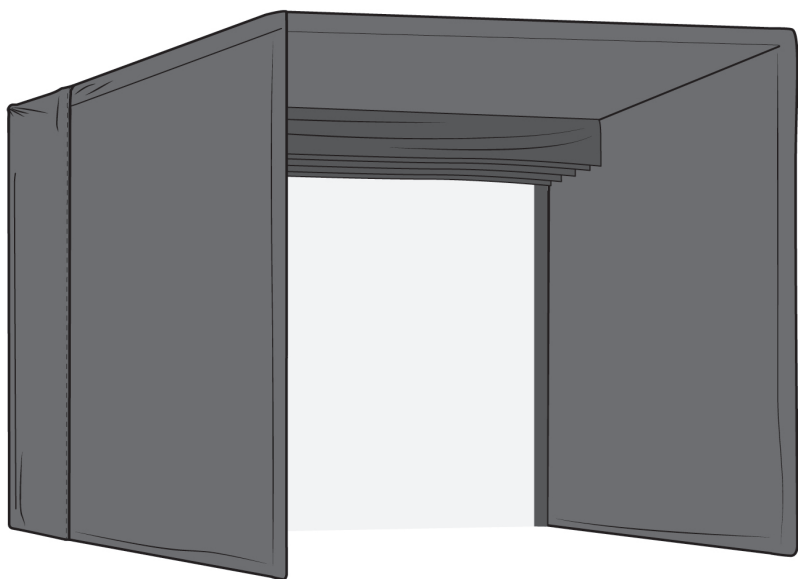

# **Enclosure Back Cover Kit**

Assembly Instructions & User Manual



Thank you for adding our back cover to your golf enclosure! We appreciate your trust in our product and are delighted to be a part of enhancing your golfing experience. This manual will walk you through each step of the assembly process.

## Materials List

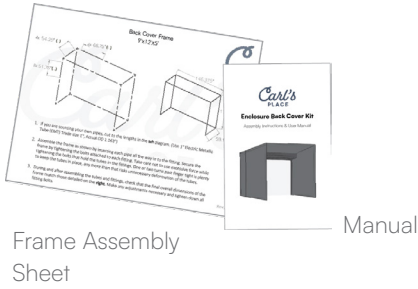

### Tools Needed

- For Pro enclosures: 6mm Hex
- For DIY enclosures: 1/2" socket
- Rubber mallet
- Step Ladder (8-ft recommended)
- Optional. A friend ready to lend a hand

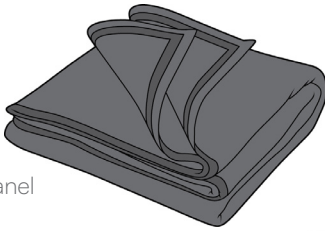

(1) Back cover panel

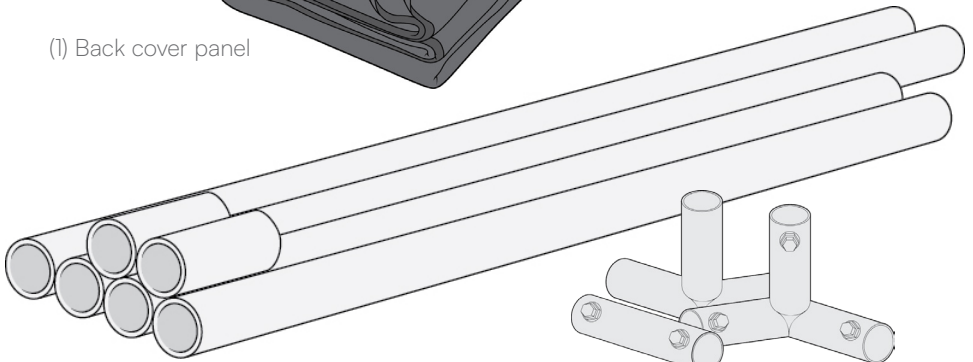

(1) Kit of pre-cut and marked pipes *OR* self-sourced, if pipes were not purchased

(1) Kit of pipe connector fittings

**If you did not buy a pipe kit from Carl's Place,** you must source your own pipes, cut to the specifications shown on the Frame Assembly Sheet.

## Assemble the Pipes

Begin adding the back cover kit to your golf enclosure by assembling and installing the pipes onto the existing enclosure frame.

Depending on the size of enclosure, you may have to assemble both the horizontal and vertical pipes.

Fully insert the pipes into each end of the straight connector fitting (as labeled on the Frame Assembly Sheet). Tighten the fitting bolts.

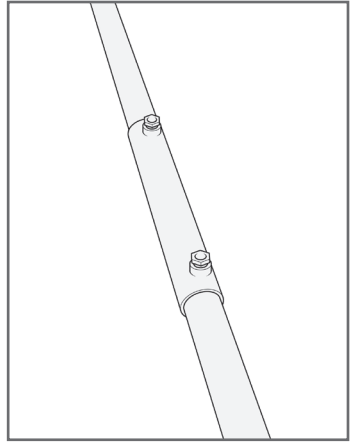

Next, attach the 3-way fittings to both ends of the horizontal pipe. Tighten the fitting bolts.

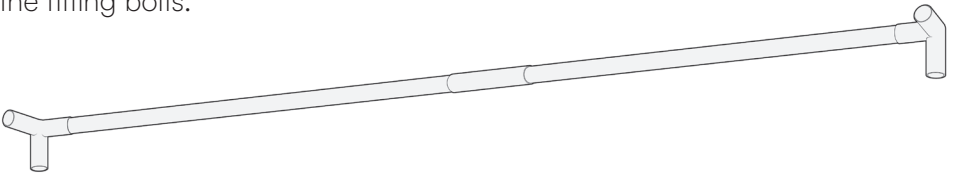

## Insert Mini-Pipes onto the Existing Frame

Starting at the top, fully insert mini-pipes into each top rear enclosure fitting. Make sure they are securely in place and then tighten the fitting bolts.

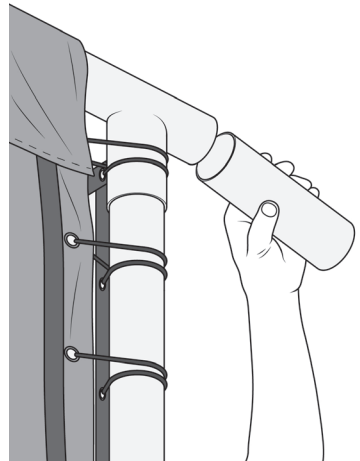

## Place the Horizontal Pipe onto the Mini-Pipes

Lift the fully assembled pipe and slide the fittings onto the installed mini-pipes. You may need to use a rubber mallet to line them up.



### *Carl's Tips*

If any pipes are not fitting properly, double-check that they are fully inserted into the fittings.

## Insert the Vertical Pipes

With the top of the back cover frame complete, it's time to insert the vertical pipe. Start by sliding the vertical pipe up into the top fitting.



Then, angle the pipe into the bottom fitting. Once in position, tighten the fitting bolts securely to ensure stability.

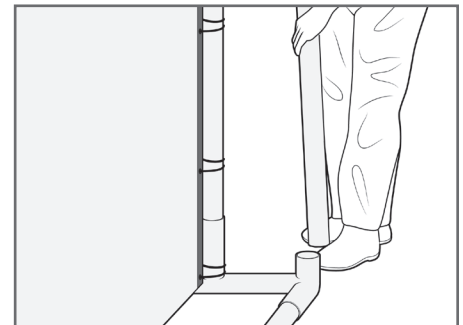

Congratulations! The frame is now complete. All that's left is to attach the back cover fabric panel.

To start the installation of the back cover's black fabric panel, we'll work from the bottom to top.

### Orient the Back Cover Panel

Take a moment to orient the back cover panel. The side with multiple hook-and-loop fastener straps is the bottom of the panel. These will wrap around the bottom pipe. The hook-and-loop fastener strips face the inside of the enclosure.

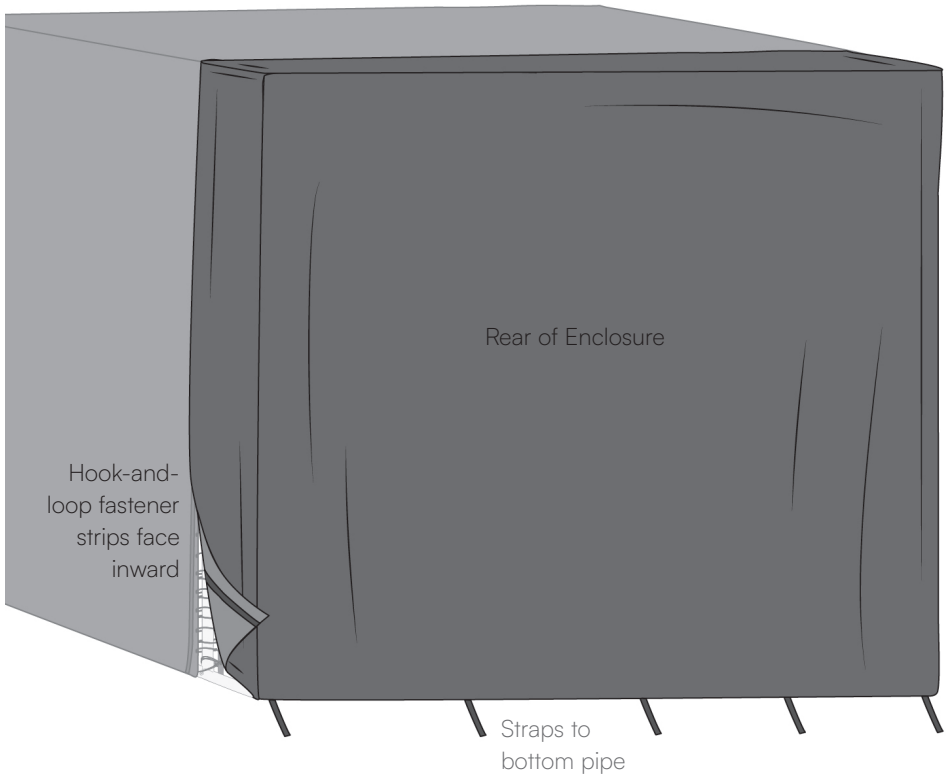

## Line Up the Edges of the Back Cover Panel

On each side of the enclosure, align the hook-and-loop fastener strip on the back cover panel, with the exposed hook-and-loop fastener strip on the side of the enclosure.

Attach the strips just enough to keep the panel in place.

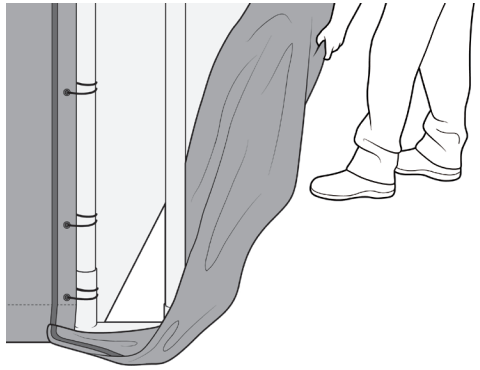

## Wrap the Straps Around the Bottom Pipe

Remember those straps we had you orient to the bottom? Securely wrap the straps around the bottom pipe.

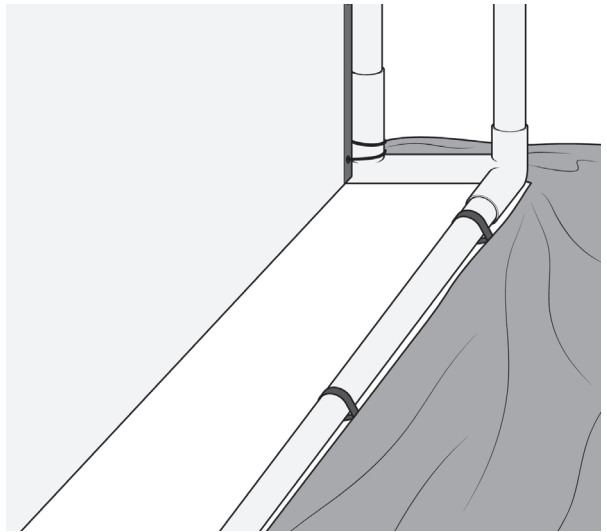

### *Carl's Tips*

To make wrapping the straps around the bottom pipe easier, place blocks of wood underneath it to lift it up.

## Lift and Secure the Back Cover

Carefully lift the back cover panel upward.

Connect the hook-and-loop strips up and around the top of the enclosure.

Re-align and smooth out any parts of the back cover for a neat and professional look. Over time, any creases that resulted from folding will naturally smooth out.

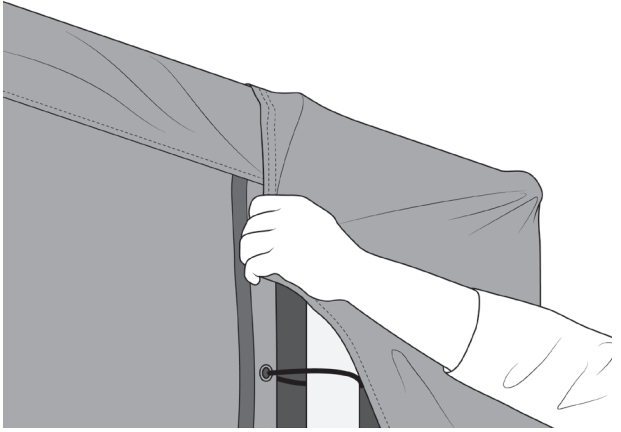

## Now, it's time to tee off!

### Send Carl a Picture!

We want to see your golf setup! Scan the QR code or go to [www.carlofet.com/share-with-us](http://www.carlofet.com/share-with-us). Send us pics. Videos. Rave reviews. Or even recommendations.



More of a social creature?

Tag us and throw a quick #mycarlsplace on your post.

We just may feature your golf simulator in our next campaign.

Anything else we can help you with?



info@carlofet.com



(608) 352-0002, Monday-Friday, 8am-4pm CT

Customers who do not follow the assembly, instructions and tips in this manual increase their risk of injury. Take proper safety precautions to protect ceilings, walls, windows, cars and neighboring homes. Keep children, pets and spectators out of swing range. **By using any Carl's Place product(s), you agree to the Terms and Conditions, as well as the Privacy Policy and any policies referenced on [www.carlofet.com](http://www.carlofet.com).**

Thank you for your business!

Carl's Place LLC, 1650 Putman Pkwy, Milton, WI 53563

Questions? Comments? We welcome your feedback!

[www.carlofet.com](http://www.carlofet.com) | [info@carlofet.com](mailto:info@carlofet.com) | (608) 352-0002