

ORIGINAL VERSION



M7 GPS Electric Trolley
Instruction Manual

EN

REGISTER ONLINE

www.motocaddy.com/warranty



IMPORTANT: Scan the QR code to ensure that your M7 GPS software remains up to date and performance is always optimised



Distance Measurement Device (DMD) features are legal to use when local USGA and R&A rule 4.3 is in effect. Always check local and competition rules prior to commencing play



Visit www.motocaddy.com/instructions for other Motocaddy instructions including translations

Cellular Performance Plan

PERFORMANCE PLAN

Powered by next-generation cellular data technology, the Motocaddy *Performance Plan* is available through a low-cost annual subscription package that unlocks a selection of premium performance-enhancing features, including:

1. Full hole mapping
2. Detailed green view
3. Advanced statistic tracking
4. Performance analysis
5. Automatic course updates
6. Notification of software updates

All M7 GPS owners receive a no-obligation 12-month FREE trial. Follow the on-screen prompts to get started.



LEARN MORE: Scan the QR code or visit www.motocaddy.com/performance-plan

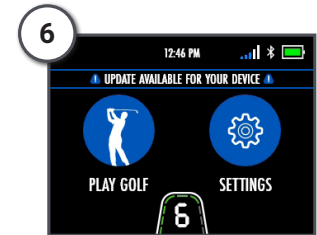
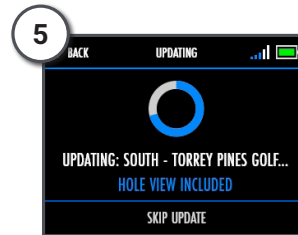
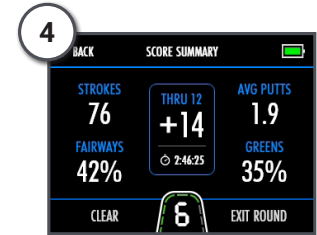
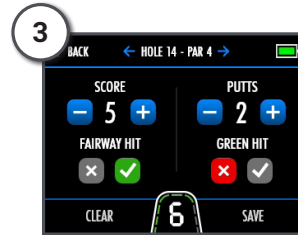
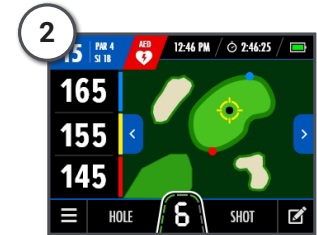
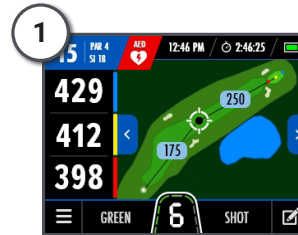

IMPORTANT - Software Updates

The M7 GPS has been developed to include WiFi powered, Over-the-Air course and system updates. It is recommended that you always use the latest firmware to take advantage of new features, bug fixes and system improvements.

Join our dedicated M7 GPS mailing list by scanning the QR code or visiting www.motocaddy.com/support/m7gps.



Locating your Serial Number

The serial number is located on the trolley underside next to the motors (fig. 1). This number is required when registering your warranty online and should be kept handy for future use.

The same number should also be on the box received with your trolley. Please ensure you keep hold of the packaging in case you need to return your trolley for any reason. A proof of purchase must also be kept in case your trolley requires servicing during its warranty period.



Fig 1

Please keep a record of your trolley serial number here for future reference:

M	C	M												
---	---	---	--	--	--	--	--	--	--	--	--	--	--	--

Information about DHC (Downhill Control)

The letters DHC stand for 'Downhill Control' and mean that your trolley will maintain a controlled speed whilst travelling down hills. Whenever you are looking to move the trolley in manual mode, even if just to reposition it ready to use, always put it on a low speed setting to make it easier to steer.

Equipment Overview

1. LCD Touchscreen Display (see page 24)
2. Manual Speed Controller & On/Off Button
3. USB Charging Port (under handle)
4. Remote Control Handset & Cradle
5. Upper Release Latch
6. Upper Bag Support
7. Battery
8. Battery Connector
9. EASILOCK™ Lower Bag Support
10. Front Wheels
11. Front Wheel Alignment Adjusters
12. Rear Wheels
13. Rear Wheel Release Button
14. Auto-Open Stand
15. Lower Release Latch
16. Motors (under Battery Tray)
17. Anti-Tip Wheel Release
18. Anti-Tip Wheel

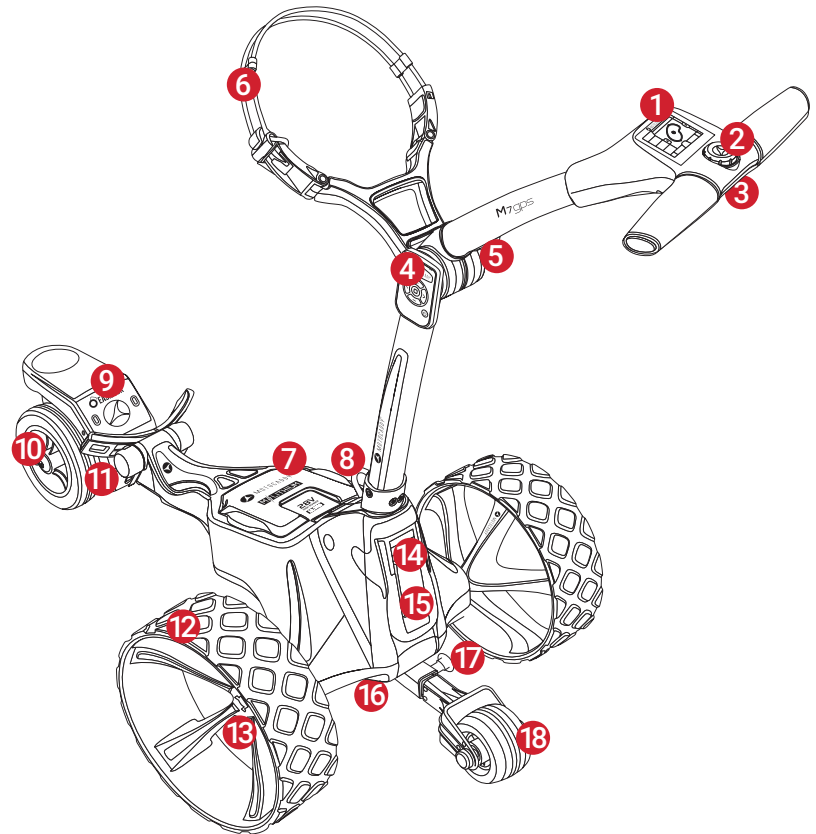

Remote Control Handset

1. Indicator LED
2. Plus (+) Button
3. Stop Button
4. Left (<) Button
5. Right (>) Button
6. Minus (-) Button
7. On/Off & Lock Button
8. Charging Port

The remote handset contains a rechargeable Lithium battery. The handset can be recharged using a mini USB cable (supplied), the charging port is located under the rubber flap at the base of the handset. Once plugged in, the handset needs to be switched on using the 'On/Off' button to charge.

The green LED on the handset will flash whilst being charged, once it is fully charged the green LED will be on and not flashing. This will take around 4-5 hours from empty.

When the handset battery starts to get low, the LED will flash red when pressing a button. Should the battery go completely flat there will be no LED when pressing a button. Should this happen, the trolley will stop. You can recharge the handset using the USB port on the trolley.

Please be aware that charging the remote handset through the USB port will take power from the main trolley battery and prolonged charging will reduce the trolley battery capacity between charges.

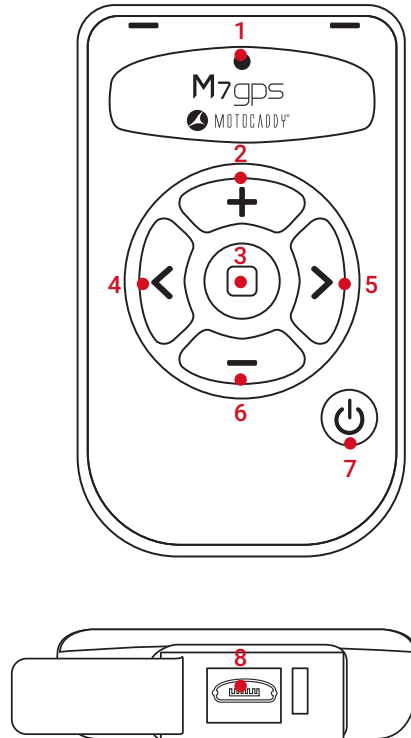

Trolley Safety

Safe use of your Trolley

The first time you use the M7 GPS, we would advise using it on an open area of grass. The trolley speeds and steering characteristics will vary depending on the surface. The M7 GPS will turn much quicker on hard, smooth surfaces and will behave differently on grass. You will also find that the weight of the golf bag will affect both speed and steering.

Motocaddy trolleys are designed for the transportation of golf bags and clubs contained within. Using the trolley for any other purpose may cause damage to the trolley and cause harm to the user. Caution and common sense should always be used.

- Never aim the M7 GPS at other people or golf trolleys;
- When using the M7 GPS in confined spaces (for example car parks) or near water (such as over bridges) it is advisable to use the 'Manual' control mode to ensure that you remain in control;
- Never let the trolley run out of your sight. Always use proper care and control;
- Do not attempt to transport any other equipment;
- The trolley is not designed for the transportation of people;
- The maximum rated load suitable for this trolley is 20kg;
- Do not use the trolley to assist you when walking up hills;
- Submerging the trolley in water (e.g. a lake) is likely to cause damage to the trolley;
- Do not operate the trolley whilst under the influence of drugs or alcohol;
- This trolley can be used by children aged from 8 years and above and persons with reduced physical, sensory or mental capabilities or lack of experience and knowledge if they have been given supervision or instruction concerning use of the trolley in a safe way and understand the hazards involved. Children shall not play with the trolley. Cleaning and user maintenance shall not be made by children without supervision;

Do not attempt to steer the trolley manually when being used in Remote Control mode. Motocaddy cannot take responsibility for any damage or injury caused from improper use.

Safety cut-out

This Motocaddy trolley is fitted with safety cut off features. Whilst operating the trolley via the remote control, if no command is sent to the trolley (any buttons pressed) for longer than 120 seconds, the trolley will stop. Whilst moving, if the trolley travels out of range of the remote control, the trolley will also cut power to the motors. Whilst operating the trolley in manual mode, if no adjustment to the speed is made via the dial for longer than 10 minutes, the trolley will stop. If any of these safety features initiate, pressing the On/Off button or the "+" button of the remote handset will restart the trolley.

Caring for your Trolley

Although your Motocaddy trolley has been weatherproofed, please follow these simple guidelines to help protect your trolley:

- Do not store your trolley outside and minimise exposure to rain as much as possible with an umbrella during heavy rainfall;
- Wipe excess water from the trolley prior to storage;
- Never use a pressure washer to clean your trolley. To prevent water damage, wipe down with a damp cloth;
- Avoid using high pressure air hoses near moving components;
- Avoid exposure to items which may scratch, damage or exert excessive force on the LCD display;

This trolley is designed to require very little maintenance. We do however recommend checking before each use to ensure:

- There is no build up of excess mud and dirt;
- The rear wheels are securely fitted and turn freely;
- The front wheels are not clogged up and turn freely;

Only original Motocaddy parts should be used when repairing your trolley.

If you experience an issue with your trolley, please contact our support team for further assistance.

Important Battery Safety & Care

Important Battery Safety & Care Information

- Always recharge as soon as possible after finishing your round, regardless of the number of holes played - ideally within 12 hours. Leaving batteries uncharged for extended periods may reduce capacity and could pose a significant safety risk which could result in fire when the battery is charged. Batteries should always be fully charged prior to storing for long periods;
- Never leave batteries charging for longer than necessary - disconnect once the green LED light indicates the battery is fully charged;
- Ensure that only Motocaddy 28V Lithium batteries are charged with Motocaddy 28V Lithium battery chargers (Model LC-2323) and the charger is always connected to an earthed socket outlet;
- Batteries must be stored and charged on a dry, non-carpeted surface at a temperature ranging between 10°C and 30°C - charging outside these temperatures may reduce capacity;
- The battery and charger must only be opened and maintained by authorised personnel. Unauthorised opening increases the risk of safety issues and will invalidate your warranty;
- Take care not to drop the battery as this may cause damage to the internal cells which could affect battery performance and safety;
- Regularly check the battery for visible signs of damage. Do not charge or use the battery if any damage is suspected - contact our Technical Support team immediately for advice;
- Use a damp cloth to clean off any dirt, but try to avoid getting the battery too wet (i.e. do not submerge, avoid deep puddles & do not clean your trolley with the battery in the tray);
- **WARNING:** For the purposes of recharging the battery, only use the detachable supply unit provided with this trolley;
- If the supply cord is damaged, it must be replaced by Motocaddy, authorised Service Agents or similarly qualified persons to avoid a hazard;

- The battery supplied with this trolley contains battery cells that are non-replaceable;
- Only battery model 28.8V High Power ULTRA 316Wh can be used with this trolley;
- Exhausted batteries are to be removed from the trolley and safely disposed of;
- If the trolley is to be stored unused for a long period, the battery should be removed;
- The battery supply terminals must not to be short-circuited;

IMPORTANT - As with any electrical device, it is not recommended to leave batteries charging overnight or for prolonged periods without supervision. Motocaddy Lithium batteries can be fully-charged from empty in less than 5 hours, so wait for the charger light to turn green, switch off at the wall and unplug the battery ready for your next round.

WARNING - If the charger LED light flashes RED and/or GREEN consecutively when connected to the battery, this indicates there is likely to be a fault with the battery or charger. It is important that you disconnect the charger immediately and contact our support team for further assistance. Do not attempt to use the battery or charger as this could pose a significant safety risk which could result in fire.



We are dedicated to protecting the environment and encourage the recycling of Motocaddy products. Exhausted and damaged batteries should be safely disposed of through a local recycling point (where available). Alternatively, please contact our support team for further information regarding safe and responsible disposal.

Charging your Lithium Battery

Charging your Lithium Battery

The Lithium battery can be left on the trolley or removed for charging. It is possible to charge the battery while the trolley is folded or unfolded. Always unplug the battery prior to folding the trolley or charging the battery.

1. Plug the Motocaddy 28V Lithium battery charger into an earthed mains power socket
2. The charger light will be GREEN when not attached to a battery to indicate that it is ready to charge
3. Attach the battery cable to the charger matching the black and grey connections
4. The charger light will provide an indication of charging phase:

 RED - Battery charging   GREEN - Battery fully charged and ready to be disconnected

5. The charging process will take between 3 to 5 hours depending on the depth of discharge.
This may take longer for the first few charges
6. Once charging is complete, disconnect the charger from the mains power supply and battery

If you connect the battery to the charger and the light goes out, this is likely to indicate that the battery is fully charged. Please double check the battery on the trolley to ensure that it is fully working.

WARNING - If the charger LED light flashes RED and/or GREEN consecutively when connected to the battery, this indicates there is likely to be a fault with the battery or charger. It is important that you disconnect the charger immediately and contact our support team for further assistance. Do not attempt to use the battery or charger as this could pose a significant safety risk which could result in fire.

Recommendations for hibernation of Lithium Batteries during winter months

If for any reason your Lithium battery is not going to be used for lengthy periods, e.g. 3-months over the winter, the battery should be stored fully charged. Before the battery is used again, recharge it (top it up) prior to use. The battery must not be left for longer than 2-months without charging as this could invalidate your warranty.

We recognise that extended absences are not always planned in advance, however when it is likely that you will not be using your battery for a period of time it is good practice to follow these steps to extend the life of your Lithium battery. Always recharge as soon as possible after finishing your round, regardless of the number of holes played - ideally within 12 hours. Leaving batteries uncharged for extended periods may reduce capacity and could pose a significant safety risk which could result in fire when the battery is charged. Batteries should always be fully charged prior to storing for long periods. Please ensure that the charger is ALWAYS disconnected from the battery after charging.

Battery Management System (BMS)

Motocaddy Lithium batteries are fitted with a comprehensive battery management system (BMS) to protect the battery from excessive abuse, high currents, deep discharge and overcharge. When the battery is delivered there may be no output as the BMS is designed to maximize safety whilst shipping. Please ensure that the battery is fully charged prior to connecting it to your trolley as this will activate the BMS and effectively 'switch-on' the battery. From time to time, at deep discharge or long term storage the BMS may switch-off the battery. A full battery charge will rectify this problem.

Motocaddy golf trolleys are designed to work with the BMS system installed in the Lithium batteries and the battery meter is also synchronised to work in conjunction with the battery. If for any reason the voltage on the battery falls below the low battery warning on the trolley, then the BMS may disable the battery to protect it. Again if this occurs please recharge fully. Please be aware that Lithium batteries tend to 'drop off' quickly at the end of the cycle so it is not advisable to attempt to play excessive holes as the BMS will activate for protection purposes.

Attaching the Wheels / Inverting the Wheels

Attaching the Wheels

This trolley does not have a specific left and right wheel. To attach the rear wheels, follow these simple steps:

1. Push and hold the quick release button in towards the centre of the wheel
2. Slide the wheel onto the trolley axle as far as it will go (onto the inner groove)
3. Once in position, release the button and pull the wheel outwards slightly to lock
4. An audible 'click' will confirm the wheel is in the correct position

Once correctly attached onto the inner groove, the wheels will not rotate freely in either direction.

The outer groove can be used as a "free-wheel" option if you run out of battery power. Simply slide the wheel onto the outer groove and pull the wheel outwards slightly to lock. Once connected, the wheel will spin freely without resistance in both directions.

Inverting the Wheels

The rear wheels can be inverted to reduce the trolley width for transportation and storage.

1. Push and hold the quick release button while sliding the wheel off the axle
2. Flip the wheel over, push and hold the button, then slide onto the axle
3. Release the button and pull the wheel out slightly until it engages with the free wheel groove

It is important the wheels are not pushed on too far. They should not touch the chassis.

Attaching the Anti-Tip Wheel

The Anti-Tip wheel is designed to prevent the trolley from tipping backwards on steeper inclines and it is recommended that the wheel is ALWAYS fitted when navigating using the remote control handset.

To attach the wheel, simply pull the grey button on the right-hand side out and slide the wheel attachment into the housing. There will be a 'click' when the wheel is securely fitted.

To remove the wheel, pull the grey button out and slide the attachment out of the housing.

The Anti-Tip wheel can be removed for cleaning and storage purposes.

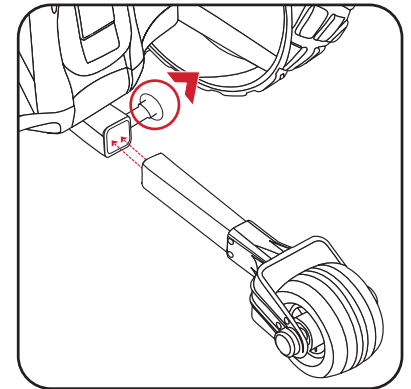

Setting the trolley to run straight

Adjusting the Front Wheel Alignment

If your trolley is not running in a straight line, there are a couple of adjustments that can be made. The problem can be caused by a number of factors including a slightly loose bag support or unevenly packed bag. The first thing to alter is the front wheel alignment:

1. Place the trolley on a flat level surface. Set the rear wheels to "free-wheel" mode (see page 12) and push to check alignment
2. Rotate the front wheels 180° to allow access to the quick-release lever (fig. 1) and pull down the quick-release lever (fig. 2)
3. There are two small metal dials on either side of the housing that are used to realign the wheel (fig. 3)
4. If your trolley is veering to the right, you will need to turn the left hand dial clockwise and the right hand dial anti-clockwise
5. If your trolley is veering to the left, you will need to turn the right hand dial clockwise and the left hand dial anti-clockwise
6. Push the quick release lever back up until it firmly clips in to place (fig. 4)
7. Rotate the wheel back 180° so that it sits underneath the housing (fig. 5)

This procedure can be carried out until the trolley is moving in a straight line (you may only need to adjust one dial at a time).

These instructions are based on being in front of the trolley looking at the wheel whilst it is in front of the housing.

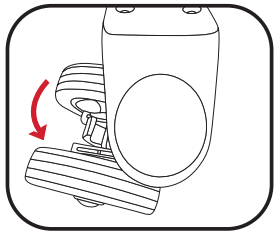

Fig 1

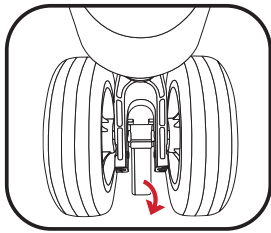

Fig 2

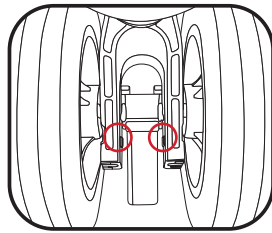

Fig 3

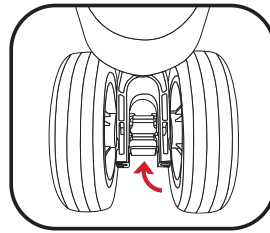

Fig 4

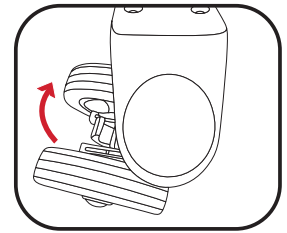

Fig 5

Motor Trimming

If the trolley is now running straight in remote mode, but not in manual mode then the motors will need trimming. This will adjust the speed of the selected motor to account for any imbalances.

1. Place the trolley on a flat, level surface and ensure the trolley is stationary (not moving)
2. From the Home screen, select "Settings" and then "Motor Trimming"
3. Read the on-screen instructions and press "Next" when ready (fig. 1)
4. Select whether your trolley is pulling to the left or right (fig. 2)
5. Select the required adjustment level from 1 (lowest) to 9 (highest) using the "+" and "-" buttons (fig. 3)
6. Press "Save" to store settings and exit motor trimming mode
7. Check the trolley is now running in a straight line and repeat steps 1 to 6 if further adjustment is required

It is recommended to start trimming gradually (adjustment 1 to 3) and then increase if necessary.

Motor Trimming will only affect trolley direction under manual (non-remote) control. It is strongly recommended to adjust the front wheel alignment before continuing with Motor Trimming. To reset Motor Trimming to factory settings, follow the steps above, but select "0" (increase to "1" and then back down to "0") and save.



Fig 1 - Motor Trimming

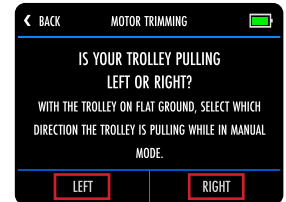

Fig 2 - Motor Trimming

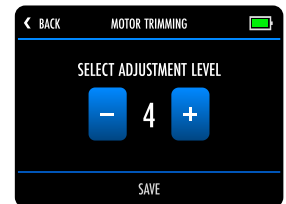

Fig 3 - Motor Trimming

Unfolding your Trolley

Unfolding your Trolley

We recommend unfolding your trolley once the wheels have been un-inverted and re-attached (see page 12).

1. Lift the upper bag support slightly and release the upper latch (fig. 1)
2. Unfold the handle and re-secure the latch (fig. 2)
3. Release the lower latch (fig. 3)
4. Lift the trolley handle up into position (fig. 4). The front wheel will automatically unfold
5. Re-secure the lower latch and ensure the auto-open stand is folded away (fig. 5)
6. Insert anti-tip wheel (see page 13)

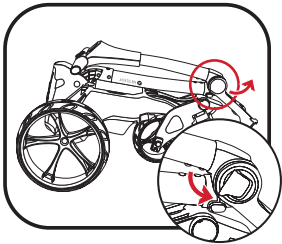

Fig 1

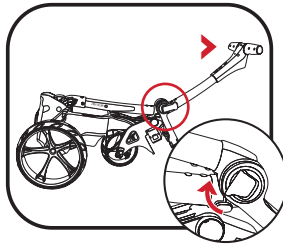

Fig 2

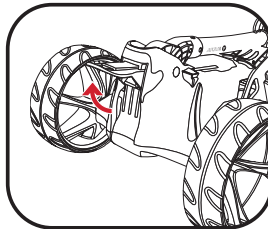

Fig 3

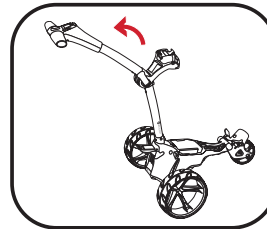

Fig 4

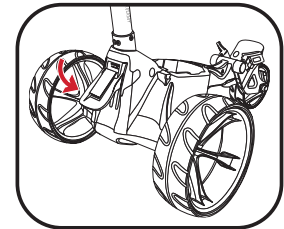

Fig 5

Folding your Trolley

1. Release the lower latch (fig. 1). The auto-open stand will also be activated
2. Fold the frame forward until fully extended (fig. 2). The front wheel will automatically fold underneath
3. Release the upper latch and fold the handle back until the trolley is fully folded (fig. 3)
4. Re-secure both latches. If you wish to stand the trolley upright, leave the auto-open stand out. Remember to ensure the auto-open stand is pushed down if not being used (fig. 4)
5. The wheels can be inverted to reduce the trolley width for transportation and storage (fig. 5). See page 12 for details

Please ensure the auto-open stand is folded away when not in use to prevent damage. The anti-tip wheel will need to be removed if you are planning on standing the trolley upright for storage.

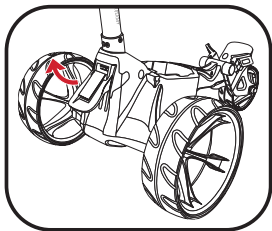

Fig 1

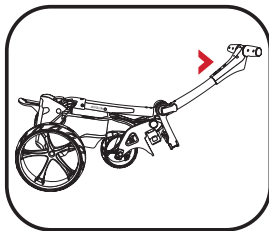

Fig 2

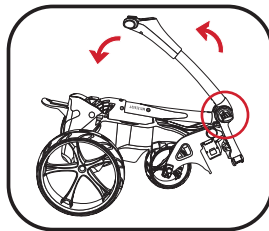

Fig 3

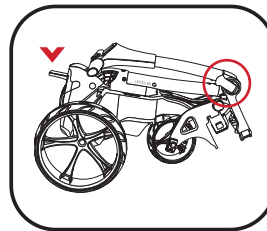

Fig 4

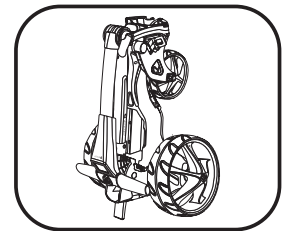

Fig 5

Lower Bag Supports

Lower Bag Support with EASILOCK™ Bag

All Motocaddy trolleys are fitted with the EASILOCK™ bag attachment system. This securely attaches the bag, reduces twisting and removes the need to use a lower bag strap.

1. If using an EASILOCK™ compatible bag, please ensure that the supplied pins are fitted to the bag base (fig. 1)
2. If attached, remove the two lower bag support elastic straps by pressing and holding the back of the clip before pulling outwards (fig. 2)
3. Align the cut out on the bag base with the lower bag support platform to align the bag pins with the holes on the trolley (fig. 3)
4. Lower the bag until the pins locate with the two holes. You should hear a positive “Click” as the bag locks into position

Lower Bag Support with Non-EASILOCK™ Bag

If you are using a non-EASILOCK™ golf bag, please do not remove the two lower bag support elastic straps:

1. Position your bag so it is resting on the lower bag support platform and in the cradle of the upper bag support
2. Stretch the lower bag strap around the bag base and loop the rounded bar underneath the bag support hook (fig. 4)

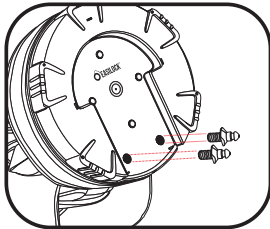

Fig 1

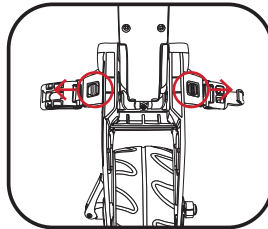

Fig 2

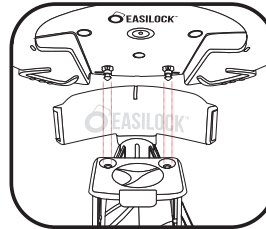

Fig 3

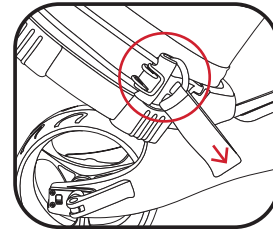

Fig 4

Upper Bag Supports

The upper bag support straps are secured in the same way as the lower straps using the following steps:

1. Stretch the elasticated strap around the bag & loop the rounded bar underneath the hook (fig. 1)
2. Position the two placement straps centrally on your golf bag (fig. 2)

Adjusting the Bag Supports

The bag support straps are manufactured from elasticated material to allow your golf bag to be held tightly in position. The strap should be adjusted to be reasonably tight around the golf bag:

1. Unclip the elasticated straps from the housing by pulling outwards in the direction shown (fig. 3)
2. Move the bar as required to tighten or loosen the strap fitting. Pulling the bar downwards will tighten, upwards will loosen (fig. 4)
3. Ensure that the straps are clipped back into the housing before use (fig. 5)

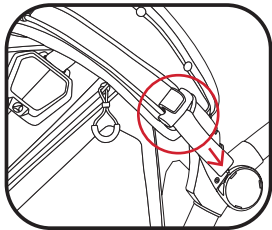

Fig 1

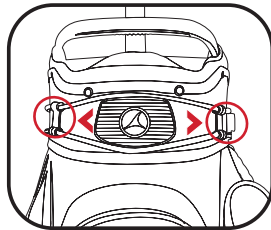

Fig 2

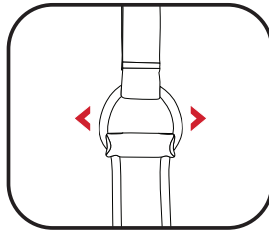

Fig 3

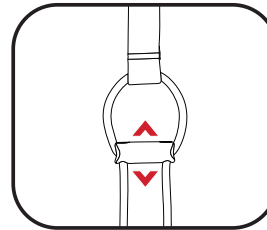

Fig 4

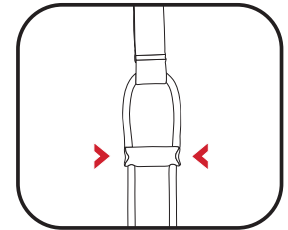

Fig 5

Pairing the Remote Control / Handset Lock function

Pairing the Remote Control

In the event that the remote is not responding or you have a new handset, it will need to be paired to the trolley.

1. Press/hold the 'On/Off' button (fig. 1a) on the remote handset until a red LED is illuminated (fig. 1b) and release the button once the red LED is no longer visible
2. From the trolley Home screen select "Settings", "Reset Remote Control" and press "Yes" to clear any existing handset pairing
3. Navigate back to the trolley Home screen
4. Press/hold the 'On/Off' button on the remote handset until a green LED is illuminated. Release the button and wait until the green LED stops flashing. This indicates that pairing has been successful

If the green LED continues to flash, pairing has not been successful. Restart the pairing process.

Handset Lock function

The remote handset can be locked by pressing the Lock button (fig. 2a), when this is pressed the LED will either flash green or red (fig. 2b). Green indicates that the handset is unlocked and red indicates locked.

When it is locked the directional buttons will be disabled and a red LED will flash when they are pressed, the Stop button will still operate and show a green LED when pressed.

If the handset is locked whilst the trolley is running in remote mode, the trolley will stop after 4 seconds as the handset will stop sending a signal. If the trolley is in Manual mode it will continue to run but can still be stopped using the Stop button on the handset.

Pressing the Lock button again (fig. 2a) so the LED flashes green (fig. 2b), will unlock the handset and all buttons will be enabled.

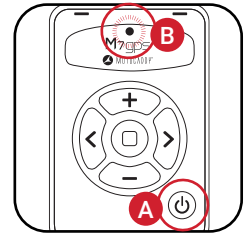

Fig 1

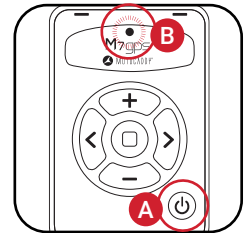

Fig 2

When the battery is initially connected, a Motocaddy logo graphic will be displayed, followed by a blank screen for around 25 seconds to allow the processor to boot up. Please do not attempt to restart the trolley during the booting procedure.

Operating the trolley using the Remote Control handset

To start the trolley, press the "+" (Plus) button on the remote control handset. The "+" (Plus) and "-" (Minus) buttons can then be used to increase and decrease the speed to the required pace, the current speed will be shown on the display.

The "<" (Left) and ">" (Right) buttons are used to steer the trolley, a quick press of the button will adjust the direction slightly at the current speed, a longer press of the left and right buttons will reduce the speed to turn the trolley, it will gradually increase the sharpness of the turn the longer the button is held. Release the button and the trolley will return to the original speed it was going.

The trolley can be stopped quickly by pressing the Stop button or gradually by decreasing the speed until it stops. The lowest speed setting in remote mode is 2, once you slow to speed 2 decreasing the speed once more will stop the trolley.

When the trolley is stationary, pressing and holding the "-" (Minus) button will put the trolley into reverse. Releasing the "-" (Minus) button will stop the trolley. The trolley will only reverse at one speed and cannot be steered whilst reversing.

It is recommended to fully-charge the remote control handset before each round of golf to optimise remote performance.

The range of the remote control handset can be affected by a number of factors including signal strength, weather conditions, remote battery capacity and radio frequency interference.

Operating the Trolley - Manual Mode

Switching the trolley to Manual mode

The M7 GPS can also be used in manual mode, allowing it to be controlled from the handle without the remote handset.

While the trolley is stationary, turn the dial to select the desired speed and press the On/Off button to start the trolley. You can also switch to manual mode whilst the trolley is moving. Simply turn the speed dial and the trolley will respond to the selected speed.

You can switch back to Remote mode by pressing the "+" (Plus), "<" (Left) or ">" (Right) buttons, it can also be stopped with the Stop button. Pressing the "-" (Minus) button will decrease the speed but will leave the trolley in manual mode.

Operating the trolley in Manual mode

The main On/Off button is used to start and stop the trolley, whilst also controlling the speed, which can be adjusted while the trolley is stationary or in motion. The trolley has 9 speed settings with 1 being the slowest and 9 the fastest.

To increase the speed, rotate the speed dial clockwise, or anti-clockwise to decrease the speed. To start the trolley, select your speed setting and press the On/Off button. The trolley will smoothly accelerate until it reaches the selected speed and the speed indicator will change from white to green to indicate that the trolley is under power. To stop the trolley, simply press the On/Off button again - there is no need to reduce the speed setting. The speed indicator will return to white.



Battery Meter

The M7 GPS includes an on-screen battery meter in the top right corner (fig. 1) which provides an indication of remaining trolley battery capacity. The battery bar is green when fully-charged. The bar will gradually reduce while turning amber and then red as battery capacity decreases.

If battery capacity gets low, a red 'low battery' warning icon will appear in the speed indicator (fig. 2). Press the On/Off button to continue using the trolley. It is recommended to disable Bluetooth, stop USB charging and limit GPS usage until the battery has been charged.

The M7 GPS also features an additional battery meter which provides an indication of remote handset battery capacity. This can be accessed by tapping the on-screen trolley battery meter once (fig. 3).

USB Charging

This trolley features a USB charging port designed to charge USB powered devices during your round.

Simply remove the covering cap and plug a USB cable into the charging port located on the underside of the handle. The device will continue charging while the cable is attached and the battery is connected.

The rate of charge will be slower than a mains AC charger and similar to plugging the device into a PC. The USB charger takes power from the main trolley battery and continuous charging will reduce the battery capacity between charges. The trolley is designed to disable the USB charging port when the battery capacity reaches a preset level.

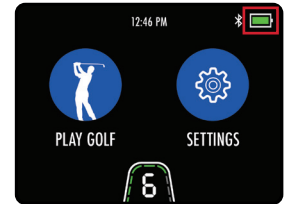

Fig 1 - Battery Meter

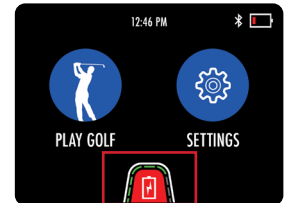

Fig 2 - 'Low Battery' Warning

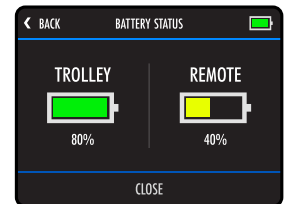

Fig 3 - Battery Status

GPS Mode Overview

GPS Mode Overview

1. Hole Number
2. Par / Stroke Index
3. AED Locator (selected regions)
4. Clock
5. Round Timer
6. Battery Indicator
7. Back Distance
8. Middle Distance / Dynamic Pin Distance
9. Front Distance
10. Previous Hole
11. Green Map with Dynamic Pin
12. Next Hole
13. Settings Menu
14. Hazard Information
15. Speed Indicator
16. Shot Measurement
17. Scorecard



Introduction to GPS Mode

The M7 GPS is pre-loaded with over 40,000 courses and includes front, middle and back of green distances, along with hole information, hazards, score tracking, shot measurement and round timer.

IMPORTANT : Distance Measurement Device (DMD) features are legal to use when local USGA and R&A rule 4.3 is in effect. Always check local and competition rules regarding the use of DMD and Push Notifications prior to commencing play.

Using GPS Mode

It is really simple to start a round in GPS mode:

1. From the Home screen select "Play Golf" (fig. 1)
2. The trolley will display "Searching" while it acquires an accurate GPS location (fig. 2)
3. A list of local courses will be displayed, with the nearest at the top (fig. 3)
4. Select the course you wish to start playing

It is also possible to select an alternative course from the settings menu within the GPS mode. Please be aware that the Round Timer and Score Tracking will be reset when a course is changed.

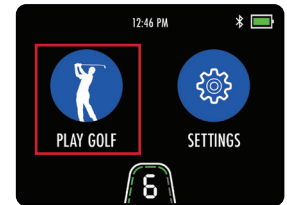

Fig 1 - Home - Play Golf

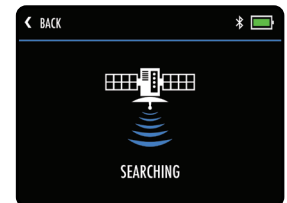

Fig 2 - Course Search

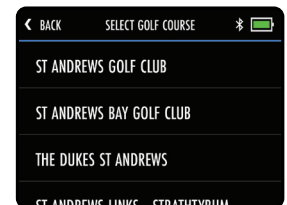

Fig 3 - Course Selection

Clock / Round Timer

Clock Settings

The M7 GPS includes a clock which is visible on the Home (fig. 1) and GPS Mode (fig. 2) screens. The clock will set automatically each time the trolley is turned on and either has a strong enough GPS signal or connects to a WiFi network.

It is possible to change the clock format and time zone settings. Starting on the Home screen, select "Settings" and then "Time" from the settings menu. You will then have the option to change the following options:

- **Format** (12 hour / 24 hour)
- **Time Zone** (GMT +/- 12 hours)
- **Daylight Savings Time** (On / Off)

Please be aware that the clock will only be displayed when an accurate time signal has been received.

Round Timer

The round timer is displayed at the top of the GPS Mode screen next to the clock and will start counting as soon as you enter GPS Mode and select a course.

You can view, pause and reset the timer (fig. 3) by selecting it on the display.

If reset, the timer will stop and you will need to select "Start" to begin counting again.

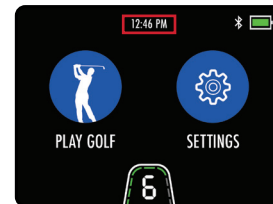

Fig 1 - Home - Clock



Fig 2 - GPS Mode - Clock

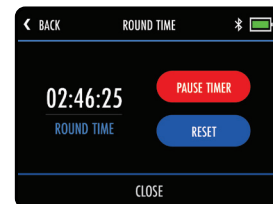

Fig 3 - Round Timer Settings

Dynamic Pin Location

The M7 GPS allows you to move the location of the pin to provide a more accurate distance measurement. Touch the point on the green that you want to move the pin to and the centre distance will update (fig. 1).

Hole Advancement

The M7 GPS will automatically advance to the next hole when you move towards the next tee.

It is also possible to change the hole manually using one of the following methods:

- Using the left and right arrows (fig. 2a)
- Touching the hole number in the top left corner (fig. 2b) and selecting the required hole
- Selecting "Select Hole" from the GPS menu and tapping the required hole (fig. 3)

Please be aware that holes will advance sequentially from the 1st hole onwards. If you are commencing play at a different location, you will need to manually advance to the required hole.

Tee Selection

It is possible to set the default tee type to display correct hole information (Par and Stroke Index).

This can be set within the Home settings or GPS Mode settings menu.

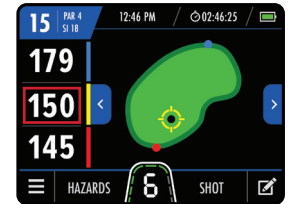

Fig 1 - GPS Mode - Pin Location

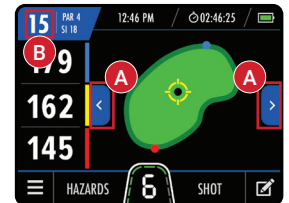

Fig 2 - GPS Mode - Hole Advance

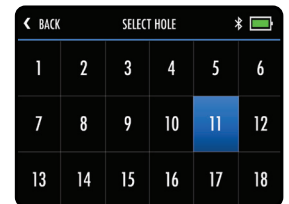

Fig 3 - Select Hole

Shot Measurement / Units of Measure

Shot Measurement

It is possible to use your M7 GPS to measure the length of a shot taken.

Distances are measured using GPS co-ordinates, which means that you do not need to walk in a straight line between shots to provide an accurate measurement. Shots can be measured in both yards and metres.

To measure shot distance, press "Shot" on the GPS Mode screen (fig. 1) before setting off to find your ball. The "Shot" text will be replaced with a yellow number (fig. 2) and start measuring the distance from the point at which it was started.

To stop measuring, touch the shot measurement distance to close.

Units of Measure

The M7 GPS can display and measure distances in either Yards or Metres. To select preferred units:

1. From the Home screen select "Settings" and then "Units"
2. Select "Yards" or "Metres" (fig. 3)
3. Select "Close" to exit

This can also be changed from the settings menu within the GPS Mode.

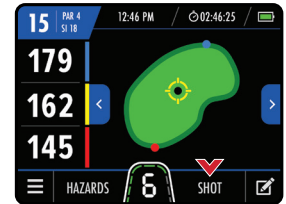

Fig 1 - GPS Mode

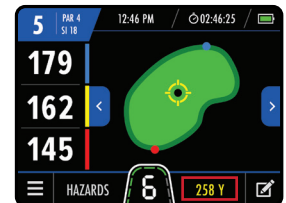

Fig 2 - GPS Mode - Shot Distance

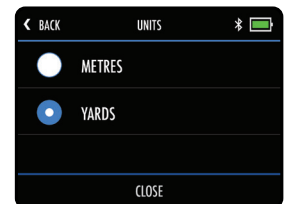

Fig 3 - Units of Measure

Hazard Information

The M7 GPS also includes a list of on-course hazards. You can view the hazards for the hole you are currently playing by selecting “Hazards” at the bottom of the GPS mode screen (fig. 1). Once selected, the screen will provide distances to the closest four hazards (fig. 2). All distances are to the front of the hazard, except carry distances which are to the back. It will only display hazards between you and the green.

You can switch back to the green view by tapping “Green” (fig. 3).

List of Hazard Abbreviations

LFB	Left Fairway Bunker
MFB	Middle Fairway Bunker
RFB	Right Fairway Bunker

LFW	Left Fairway Water
MFW	Middle Fairway Water
RFW	Right Fairway Water

LGB	Left Green Bunker
RGB	Right Green Bunker
FGB	Front Green Bunker
BGB	Back Green Bunker

LFWC	Left Fairway Water Carry
MFWC	Middle Fairway Water Carry
RFWC	Right Fairway Water Carry

CRK	Creek
CRKC	Creek Carry
EOF	End of Fairway (Doglegs)

LGW	Left Green Water
RGW	Right Green Water
FGW	Front Green Water
BGW	Back Green Water

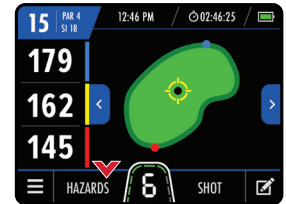

Fig 1 - GPS Mode

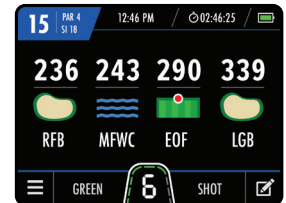

Fig 2 - Hazard Information

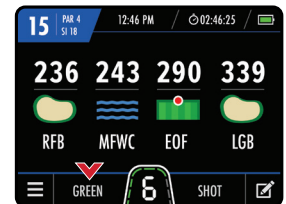

Fig 3 - Hazard Information

Score Tracking

Score Tracking

You can use your M7 GPS to keep track of your score and access a score summary at any point during the round. To enter a score, select the scorecard logo (fig. 1) at the bottom right corner of the GPS screen.

This will show the current hole information with the option to enter a score (fig. 2). Tap "+" and "-" to change the score and then select "Save" to save the score and return to the main GPS screen. You can also select the blue left and right arrows at the top of the screen (fig. 2) to scroll through the different holes and update each score.

When the green check mark is visible next to the "Enter Score" text, the score for this hole has been successfully saved. If the incorrect score has been saved, you can easily override this by updating the score and selecting "Save". Selecting "Clear" on the Score Entry screen will only reset the score on the hole selected.

You can access a score summary at any point during the round by selecting "Score Summary" from the GPS screen settings menu. The Score Summary will show 'Total Strokes' taken and 'Score' related to Par (fig. 3). To return to the main GPS screen select "Back", to reset your round score select "Clear", or if you have completed your round of golf select "Exit Round".

Please be aware that scores are not stored or accessible once a round has ended.

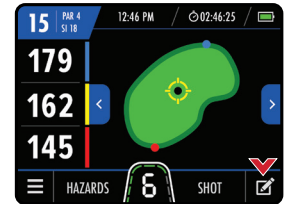

Fig 1 - GPS Mode

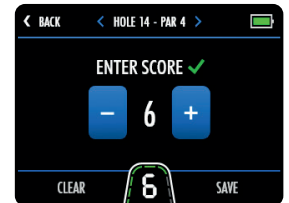

Fig 2 - Score Entry

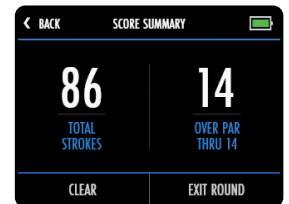

Fig 3 - Score Summary

AED Locator & CPR Instructions (selected regions)

The M7 GPS can indicate the availability and location of on-course defibrillators and provide golfers with Cardiopulmonary Resuscitation (CPR) instructions. The feature can be enabled by selecting "AED Locator" within the home settings menu and selecting "On" (Terms and Conditions apply).

If the course you are playing has an on-course defibrillator and has registered details on the Motocaddy AED database, the main GPS screen will display an AED Icon at the top of the screen (fig. 1).

Tap the AED Icon to access information about the location of on-course defibrillators and the contact number to gain access (fig. 2). From this screen, you can also access step-by-step CPR instructions (fig. 3) by selecting "CPR Instructions".

Please be aware that AED and CPR features are available in selection regions only and usage requires acceptance of the AED & CPR feature 'Terms of Use' available at www.motocaddy.com/defib-cpr-terms.

Ending your Round

The round can be ended at any point by selecting "End Round" from the GPS screen settings menu. If you have used score tracking, a score summary will be displayed with an option to "Exit Round". If you have not used score tracking, you will return to the Home screen.



Fig 1 - GPS Mode - AED Icon



Fig 2 - AED Locator

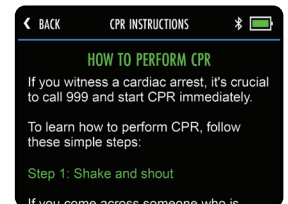

Fig 3 - CPR Instructions

Smartphone Notifications / Installing the Motocaddy App

Introduction to Smartphone Notifications

The M7 GPS trolley can be linked to the Motocaddy GPS app via a Bluetooth® connection on any compatible smartphone; allowing the trolley's LCD screen to receive optional push notifications for text messages, email, missed calls and other compatible apps. It is possible to use the M7 GPS with or without push notifications enabled.

Installing the Motocaddy Smartphone App

It is necessary to install the **Motocaddy app** to utilise the M7 GPS smartphone push notification features.

The Motocaddy GPS app is compatible with devices running iOS 9 or later and Android version 4.4 or later. Please note, not all Bluetooth enabled mobile phone handsets are compatible with the M7 GPS Bluetooth connection and pairing for other devices cannot be guaranteed. Please check your device compatibility before attempting to download the app.

To install the 'Motocaddy GPS' app, search for "Motocaddy" on either the Apple App Store or on Google Play.

Apple Devices



Android Devices



Once installed, select the Motocaddy GPS app and it will load the registration screen. When using the app for the first time, you will be prompted to allow the app to access your location and it is important that this is enabled to use standalone GPS features within the app.

We recommend that you complete the app registration process to allow us to keep you informed about future updates to both the app and push notification functionality. Please note that completing the app registration does not register the trolley.

Enabling Bluetooth

In order to pair your phone to your trolley, you will need to ensure that Bluetooth is enabled on the trolley:

1. From the Home screen select "Settings" and then "Bluetooth" (fig. 1)
2. If Bluetooth is off, select "Yes" to turn it on

When Bluetooth is enabled you will see the Bluetooth logo on the display next to the battery meter.

Pairing your Phone

To pair your M7 GPS to a compatible smartphone, you must first ensure Bluetooth is enabled on both devices (see above) and then follow the below steps:

1. Open the Motocaddy app on your phone and select "Pair Device" button (fig. 2)
2. Select the correct trolley model from the list and select "Next"
3. Further instructions will be displayed. When ready, select "Pair Device"
4. Once the trolley and phone have found each other, both devices will display a six digit code (fig. 3). If these codes match, select "Pair" on both devices
5. Both the trolley and phone will confirm that pairing has been successful
6. Select "My Device" on the phone for further settings and "Close" on the trolley screen to continue

The Motocaddy app can be closed once pairing is complete or used as an additional GPS device. Once pairing is complete, it is not necessary to open the Motocaddy app to display notifications on the trolley screen, however the app can be used to control notification settings or unpair your phone.

During initial startup, the Bluetooth on your trolley will take around 60 seconds to initialise and will automatically reconnect to your phone when in range. Bluetooth can be disabled if required.

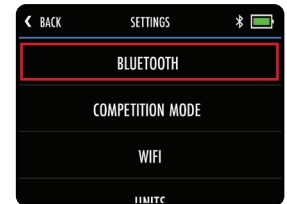

Fig 1 - Home Settings Menu

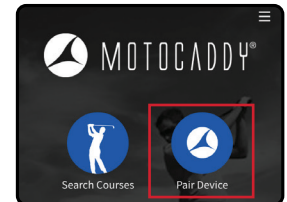

Fig 2 - Motocaddy App

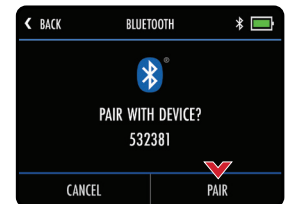

Fig 3 - Trolley Pairing Code

Notification Settings / Notification Stacking

Notification Settings

It is possible to pre-set which smartphone notification types are displayed on the trolley screen (fig. 1 & fig. 2) using the device 'Settings' menu within the Motocaddy app.

There are also other app specific notification settings within your phone that need to be enabled for the notifications to be displayed on your trolley.

For a full list of compatible apps, plus individual app notification settings (including the 'Push Notifications' option), please visit www.motocaddy.com/support/m7gps.

Notification Stacking

Notifications will be displayed in chronological order, with the oldest notification displayed at the top.

Once viewed, notifications can be closed by selecting "Close" or tapping "Back" to exit without clearing.

When multiple notifications are available, selecting "Close" will hide the current notification and display the next alert.

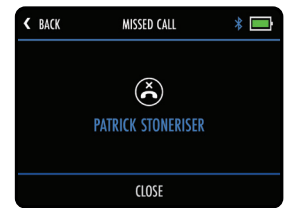

Fig 1 - Missed Call

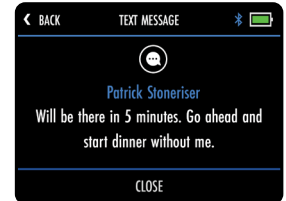

Fig 2 - Text Message

The M7 GPS is able to install course and firmware updates via WiFi powered Over-the-Air (OTA) updates.

Connecting to a WiFi Network

Before attempting an OTA update, the trolley will need to be connected to a WiFi network.

1. From the Home screen select "Settings" and then "WiFi"
2. Select "WiFi Disabled", select "On" and then select "Close"
3. Tap "Select Network" and choose the required network from the list (fig. 1)
4. Enter the WiFi password (tap the eye icon to view password) and select "Enter" (fig. 2)
5. Once connected select "Close" to exit

Firmware Updates (OTA)

To check current software version and install updates:

1. From the Home screen select "Settings" and then "Check for Updates"
2. You will be asked whether you want to check for updates. Select "Yes"
3. The trolley will search and indicate whether a newer firmware version is available
4. If there is newer firmware, you will see an option to select "Yes" or "Cancel" (fig. 3)
5. Select "Yes" to continue and install the update, or "Cancel" to return to the settings menu
6. During installation, the trolley will restart and show the Home screen when completed

We strongly recommend checking for firmware updates before using the trolley for the first time. The OTA process can take up to 5 minutes to complete. During installation, the trolley may automatically reboot multiple times and the screen will go blank. When the Home screen is displayed, the OTA is complete. It may be necessary to unpair your mobile device and re-pair after performing an OTA - see page 33.

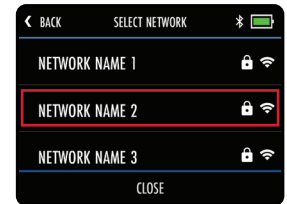

Fig 1 - WiFi Network List

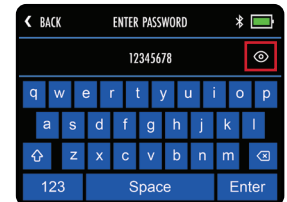

Fig 2 - WiFi Password Entry

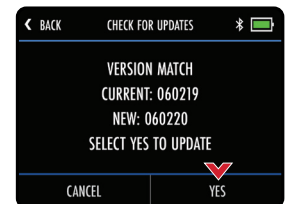

Fig 3 - Check for Updates

Course Updates

Course Updates (OTA)

The M7 GPS is pre-loaded with over 40,000 worldwide courses. To check for an updated course map, the trolley will need to be connected to a WiFi network (see page 35):

1. From the Home screen select "Settings" and then "Update Course"
2. Enter the name of the course (you do not need to enter the full name) and select "Search" (fig. 1)
3. The trolley will then display a list of courses which meet the search criteria (fig. 2)
4. Select the course that you want to update from the search results
5. You will be shown additional course information to help confirm that you have selected the correct course (if required, tap "Back" to select an alternative course)
6. Select "Update" to initiate the update (fig. 3)
7. The course will then be updated and "Updating Course" will be displayed
8. Once complete, the trolley will confirm that the course has been successfully updated
9. Select "Close" to exit

Please submit requests for mapping updates or new course mapping using the 'Report Mapping Issue' option within the Motocaddy app support menu.



Fig 1 - Course Search

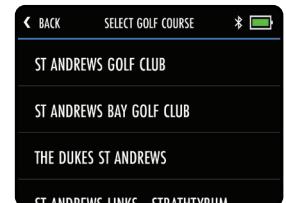

Fig 2 - Course Selection

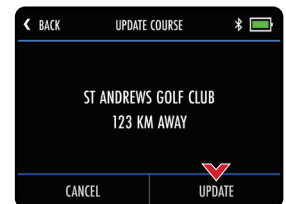

Fig 3 - Update Confirmation

Language Settings

The M7 GPS can be used in a number of different languages:

1. From the Home screen select "Settings" and then "Languages"
2. Select preferred language and then "Close" to confirm (fig. 1)

Competition Mode

It is possible to temporarily disable GPS using the competition mode should competition rules dictate. It is recommended that you always check competition rules before using your trolley with GPS enabled.

To Enable/Disable Competition mode:

1. From the Home screen select "Settings" and then "Competition Mode"
2. Select "On" (to enable) or "Off" (to disable)
3. Select "Close" to exit

When Competition Mode is enabled, the "Play Golf" option will be disabled and the Home screen will display "Competition Mode Enabled" (fig. 2).

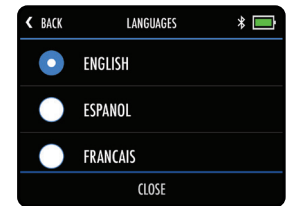

Fig 1 - Language Settings

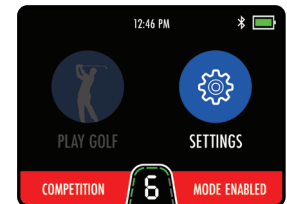

Fig 2 - Competition Mode

Factory Reset

Should you experience a problem with your M7 GPS, it is possible to reset the trolley back to its original factory default settings:

1. From the Home screen select "Settings" and then "Reset all Settings"
2. You will be asked to confirm that you want to go ahead with the reset, select "Yes" (fig. 1)
3. A confirmation screen will be displayed and select "Close" to exit

Resetting the trolley to factory default will clear any setting preferences.

Demo Mode

The M7 GPS features a Demo Mode to allow demonstration of features when a GPS signal is not available.

To enable Demo Mode, navigate to the "Settings" menu from the Home screen and select "Demo Mode".

Demo Mode can be toggled "On" and "Off". Select "Close" to confirm. Once enabled, the "Play Golf" button will display a list of demo courses (fig. 2).

It is important to disable Demo Mode before attempting to play a round of golf.

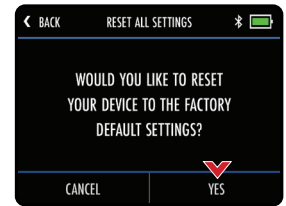

Fig 1 - Factory Reset

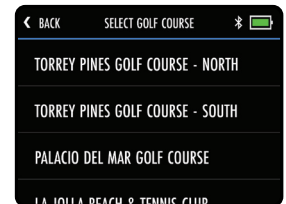

Fig 2 - Demo Mode

FCC Statement

This device complies with Part 15 of the FCC Rules. Operation is subject to the following two conditions:

- (1) This device may not cause harmful interference, and
- (2) This device must accept any interference received, including interference that may cause undesired operation.

Changes or modifications not expressly approved by the party responsible for compliance could void the user's authority to operate the equipment.

FCC Radiation Exposure Statement:

The device has been evaluated to meet general RF exposure requirement. The device can be used in portable exposure condition without RF striction.
NOTE: This equipment has been tested and found to comply with the limits for a Class B digital, pursuant to Part 15 or the FCC Rules.

These limits are designed to provide reasonable protection against harmful interference in a residential installation. This equipment generates, uses and can radiate radio frequency energy and, if not installed and used in accordance with the instructions, may cause harmful interference to radio communications, However, there is no guarantee that interference will not occur in a particular installation. If the equipment does cause harmful interference to radio or television reception, which can be determined by turning the equipment off and on, the user is encouraged to try to correct the interference by one or more of the following measures:

- (1) Reorient or relocate the receiving antenna
- (2) Increase the separation between the equipment and receiver
- (3) Connect the equipment into an outlet on a circuit different from that to which the receiver is connected
- (4) Consult the dealer or an experienced radio/TV technician for help





 Motocaddy Ltd,
Units 15 - 18 Stansted Distribution Centre,
Start Hill, Great Hallingbury, Hertfordshire, CM22 7DG,
United Kingdom

 +44 (0)1279 712 370

 info@motocaddy.com

 www.motocaddy.com

MC.23.66.003 | EASILOCK™ Patent (GB) - GB2519073 | USB Charging Port Patent (GB) - GB2473845 | USB Charging Port Patent (AUSTRALIA) - 2010224448

Apple, the Apple logo, and iPhone are trademarks of Apple Inc., registered in the U.S. and other countries. App Store is a service mark of Apple Inc.

Android and Google Play are trademarks of Google Inc.

The Bluetooth® word mark and logos are registered trademarks owned by the Bluetooth SIG, Inc. and any use of such marks by Motocaddy is under license. Other trademarks and trade names are those of their respective owners.