

Woodline USA

Woodline Spacer Fence System

MADE IN THE
USA

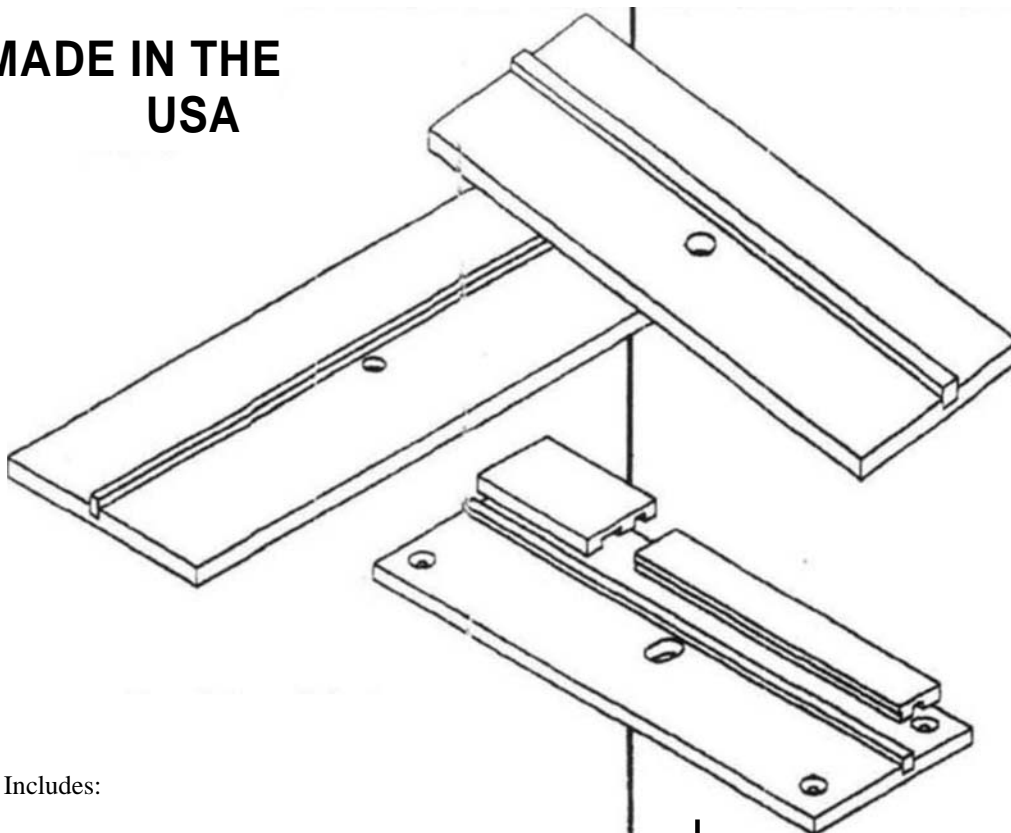

Includes:

- (1) 1/4" Spacer Fence
- (1) 3/8" Spacer Fence
- (1) 1/2" Spacer Fence
- (1) Hardware Package
- (1) 3 Piece Brass bar set
- (2) Setup Blocks

Woodline USA

1-800-472-6950

Visit Us
Online at

WOODLINE.COM

Box Joint & Dovetail Fence System (For Router Tables)

Parts List:

1	3/8" fence platform (predrilled for set up)
1	1/2" fence platform
1	1/4" fence platform
1	small set up jig
1	long offset jig or sub-fence for dovetail liners
1	bag of 1/4" diameter bolts with nuts lock washers
1	brass measuring blocks
	1 @ 3/8" square
	1 @ 1/2" square
	1 @ 1/4" square



Bits (Optional)

Woodline USA recommends Part numbers	WL-1025S 1/2" up cut spiral bit
WL-1022S 3/8" up cut spiral bit	
WL-1003S 1/4" up cut spiral bit	
WL-1312 1/2" 14 Degree dovetail bit	
WL 1314 3/4" 14 Degree dovetail	

Straight bits will work but spiral bits give optimum results and are easier to set the spacing accurately due to the helix of the bit hitting the brass bars in the proper spot.

IMPORTANT!

CAUTION: IMPROPER USE OF TOOLS CAN CAUSE SERIOUS INJURY OR DEATH. DO NOT USE THIS TOOL BEFORE READING THROUGH THE ENTIRE DIRECTIONS OR VIEWING THE VIDEO ON THIS EQUIPMENT.

CAUTION: WHENEVER PERFORMING SETUP OPERATIONS, CHANGING OF BITS, OR OTHER ADJUSTMENTS ALWAYS UNPLUG THE TOOL

NOTE: Drawings are not to scale. For further clarification a video is available showing setup in more detail. If additional technical assistance is required, contact Woodline USA at 1-800-472-6950. Woodline USA is not responsible for injury or damage caused by use of the jig. User assumes all risk of operation. It is assumed user of this system is fully familiar with power tools and safety procedures. Always use prudent judgment, safety devices, and caution around power tools.

SPACER FENCE SET UP FOR BOX JOINTS

MATERIALS NEEDED: 3/8" FENCE

3/8" Up-cutting spiral or double fluted straight cutting router bit

3/8" Brass Bar

2 "C" clamps

Scrap wood for doing your test cuts with. (softwood is best to get the feel of how the system works)

Step One: Place your 3/8" Spiral up cut or a double fluted straight bit in the router. Place the 3/8" spacer fence on the table with the bit protruding through the center hole. The router bit should protrude about 1/2" above the spacer plate. Insert a 3/8" brass bar between the fence ridge and the bit and position the fence so that the bit just touches the brass bar. The brass bar should gently touch both the ridge and the router bit. This is the proper location for a 3/8" box joint. Other size joints set up the same way but use the appropriate fence plate, bit and a brass spacer the size of the bit used.

Mounting Fences to your table:

Option 1: Clamp the plate to the router table at each end. This option only works on small tables. If you can not clamp the fence to the table proceed to option two.

Option 2 Mount the fence to a piece of 1/8" to 1/4" thick plywood 6" wide and as long as your table is wide. Drill a hole in the plywood to match the center hole in the fence plate. Use heavy duty double stick tape and some small countersunk screws through the board into the bottom of the fence to secure the fence to the plywood. Reinstall the plywood/fence assembly on the table, locate the brass bar between the bit and the fence ridge and clamp the assembly in place at the edges of the router table. Tighten up both clamps and remove the brass bar.

The addition of a plywood interface board should be repeated for each fence.

Making a push block

Push blocks assure safety and result in square joints. Always use a push block when making joints using the spacer fence system. The push block is sacrificial and will become worn with use, you may want to make more than one. An L shaped push block with a handle on it like the one shown in the picture has the advantage of being able to hold material clamped to it allowing cuts the full width of a drawer sized board without removing the material

Glue two 6" square boards into an L shape. Install a third board as a handle. The angle should be 90 Degrees. If you nail or staple the boards and handle, make sure no fasteners will be hit when routing the bottom slots. Bit damage or injury could result if you fail to exercise proper care.

Raise the bit to a height of approximately 7/16" above the spacer fence plate. Assure the plate is clamped to the table and the appropriate brass bar fits snugly between the bit and the fence ridge. Remove the brass bar. Place the wood against the ridge and slowly advance through the spinning bit. Place the slot just made over the ridge and make a second cut. Repeat until the entire bottom of the push block is slotted. The push block is now complete and ready to use. In use the material is placed against the fence and held with a small clamp. The wood and block assembly is then pushed trough the spinning bit then moved over and repeated until the joint is complete. Several boards can be clamped at once and all cut at the same time. You will probably want to make a push block for each fence size.

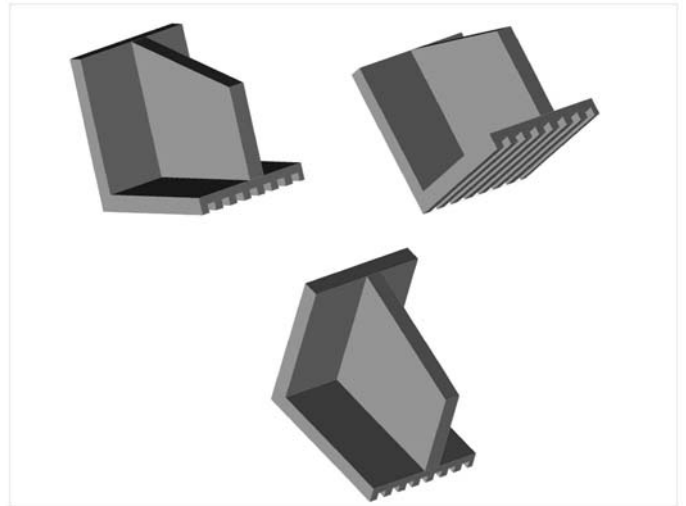

Making a box joint. (Read and understand the entire section before cutting any joints)

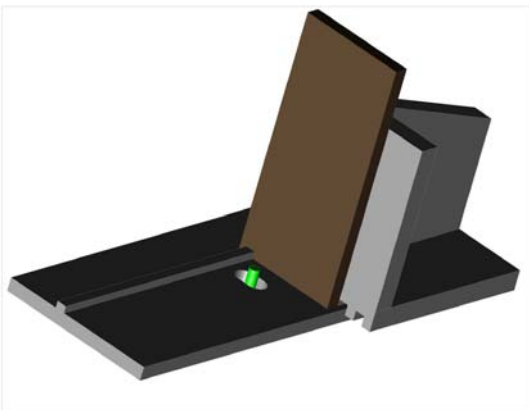

Use a piece of wood to be jointed as a height gauge to set the height of the router bit just slightly higher than the thickness of the wood. Stand the piece of wood up and hold it with one edge against the fence ridge and the face of the board firmly against the push block. Advance the push block and wood through the spinning bit making a "notch". Remove the board, retract the push block, and place the notch just cut over the fence ridge and repeat the cut making another notch. Repeat the process until the entire width of the board is cut. The resulting cuts should result in a perfectly fitting box joint.

Adjusting the fit of box Joints.

If box joints are too tight, the spacing between the bit and the fence ridge is too much. A light tap moving the ridge a very small amount toward the bit (closing the gap between the bit and the fence ridge a little) will make the joint fit more loosely.

Tapping the other direction (increasing the distance between the bit and the fence) will make the joints fit tighter. Only a slight adjustment is required. Move in small increments and cut a test joint until the desired fit is obtained.

Align edges of box joints.

Edge alignment is obtained by offsetting a board by one joint width relative to the mating board. After making the first cut in one side, rotate the board and move it over the fence placing the notch over the ridge with the larger portion of the board on the outside of the fence. But the mating board against the first board and using the push block make a cut. The result is a perfect offset amount. Now both boards are placed with the notch over the ridge and cut them at the same time. Up to 4 boards at once can easily be cut making the process of cutting drawer joints fast and accurate.

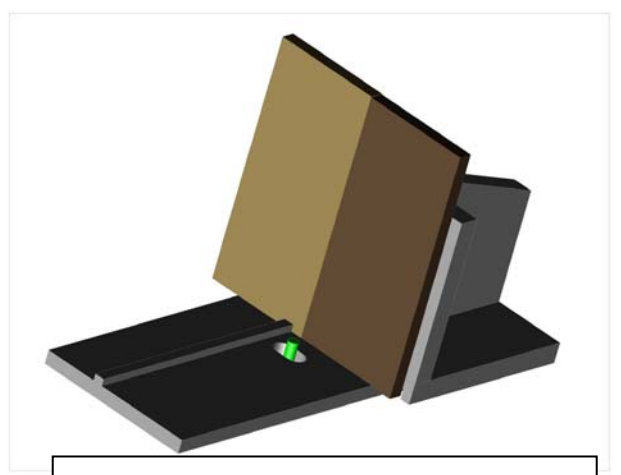

Reverse first board and place over ridge, Butt second board against it and cut the joint slowly.

DOVETAIL SET UP

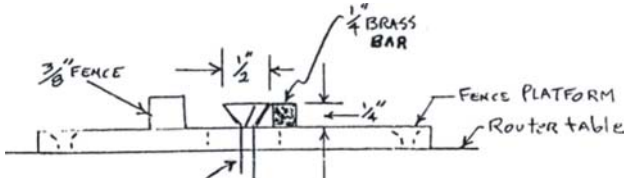

Step One: To set up the fence for the dovetails, chuck up a 1/2"-14 degree dovetail in your router. (use a push block behind your work piece in order to minimize chipping and tear out.) Bring the bit all the way to the top, Set the height of the bit to 1/4" using the 1/4" brass bar, use your finger make sure that the tip of the cutter is not above the brass bar. **Remember when using a dovetail bit the higher the bit the tighter the fit the lower the looser.** Make a test cut.

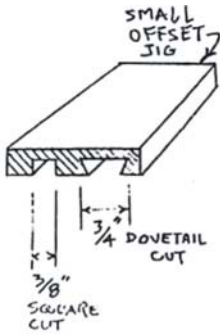

Place the small piece of the sure fit set up jig over the ridge of the fence and use the stop with of the dovetail plough as the spacer, move the fence to the left and tighten a clamp on the front of your table. (see figure at right) Clamp two pieces of wood offset approximately 3/8" using a spring clamp. (same as set up in figure 5) With a push block, make a series of cuts. The pieces should attach end to end perfectly. Raise or lower the bit to adjust the fit. This same process

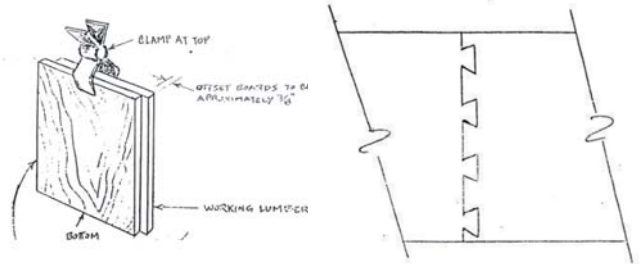

is used for end to end joinery using dovetails.

Step Two: To make a sliding dovetail use two 3/8" blocks. Remember when passing the wood through the router bit always keep the pressure on the wood to the right against the fence with the rotation of the bit. Pass one piece forward through the bit then back. "Step" across repeating the cuts to the end of the piece, rotate your first piece 180 degrees place over the fence using it as an offset for the second piece. Place your second piece against the first and keep on "walking", going forward and back on each pass, this opens the grooves slightly. If you are going to use this process for drawer glides or table extensions never use oak on oak or cherry on cherry the same species of wood will wear on each other,

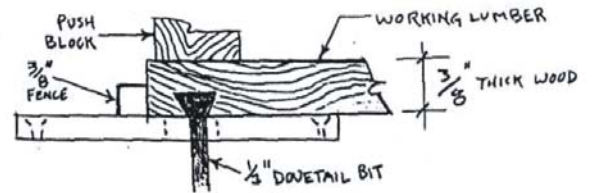

however two different species will last almost forever.

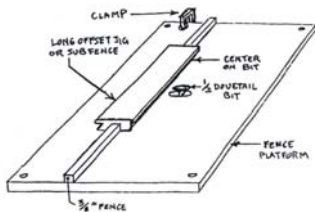

DOUBLE DOVETAIL FOR LINERS

Step One: Set up

for the liner by pivoting the 3/8" fence, place the small set up jig over the ridge of the fence and use the stop with the outside of the dovetail plough as the spacer, move the fence to the right and tighten a clamp on the front side of the table. This will give a 3/4" space; use a 3/8" thick piece of wood (thickness is important to the final result) so when you make the pass across the bit at the 1/4" height you will leave 1/8" of wood.

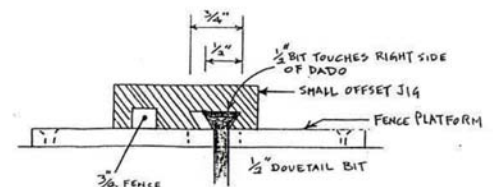
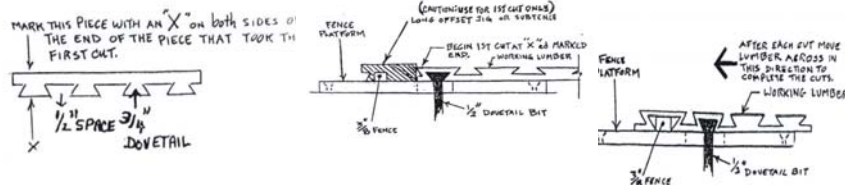

Always use a push block to keep your work piece down and your finger out of the way of the cutter, This will give you a 1/4" high dovetail and a 1/2" space between the dovetails. (see above.) Using the long offset jig, place over the 3/8" ridge of the fence with the flat side of the jig towards the bit.(see previous page) Flip the piece you're working on over, end for end and make the first pass.) This leaves 1/8" between the cutter and fence. Remove the offset block and continue "walking" across the piece. If the sides of the liner are not evenly 1/8" thick it may be because the dovetail bit isn't exactly 1/2", adjust as needed for even spacing. Once you get the set up perfected, makes several extra pieces for future use.

Step Two: MAKING THE OUTSIDE PIECES FOR THE DOVETAIL LINERS

Remove the fence and replace the 1/2" bit with a 3/4", 14-degree dovetail bit. The two bits have to be set up at the exact same height. Set the distance from the fence using the sure fit set up jig, place it on the ridge of the fence, (see figures)

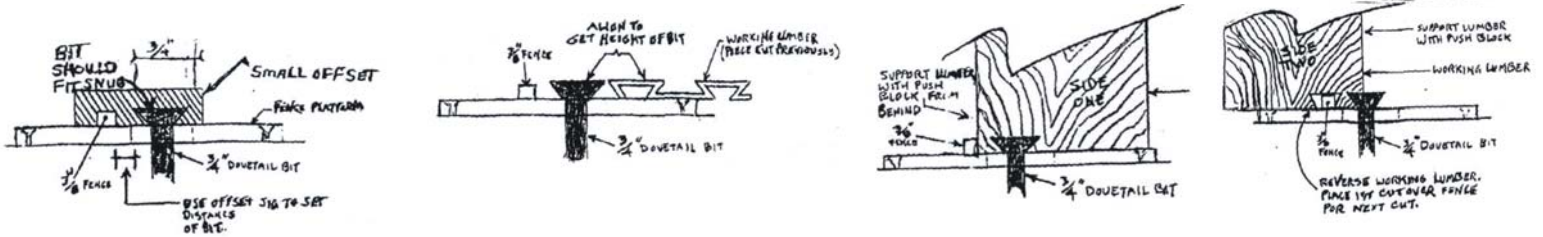

Place the bit up in the plough so that the bit touches both sides of the 3/4" dovetail cut. (if it's loose from shimming the bit, place the guide against the inside edge.) Clamp it down and check the clearance. To check this take a scrap piece of wood stand the board on end and pass through the cutter (see figure 22.) turn the wood and place the cut over the ridge of the fence and cut the other side of the wood leaving a 1/2" tail. You will have a 1/4" cut with a 1/2" tail, place this piece into your liner to check fit. If the dovetail fits in the liner, continue your cuts. This is one side of the outside pieces to the liner. To line up the second piece there has to be a 1/4" cut on the outer edge of the board in order for the three pieces to line up. To make the second piece place the long offset jig over the ridge of the fence with the dovetail side towards the cutter, make the first pass with the second piece of wood. Remove the long offset and continue to walk across the piece. When you glue up, leave approximately 1/32" of the liner protruding. Either power sand or use a Japanese flexible saw and saw off the excess.

The rotation of the router bit on the forward pass will push the wood against the fence, moving it back may tend to pull the wood away from the fence but will clean out the plow cut. Turn the piece around placing the dado groove over the top of the fence ridge. (The tail between the dado and the bit will be the same spacing to insure you with a flush fit.) Stand your second piece on edge and make your rabbit cut.

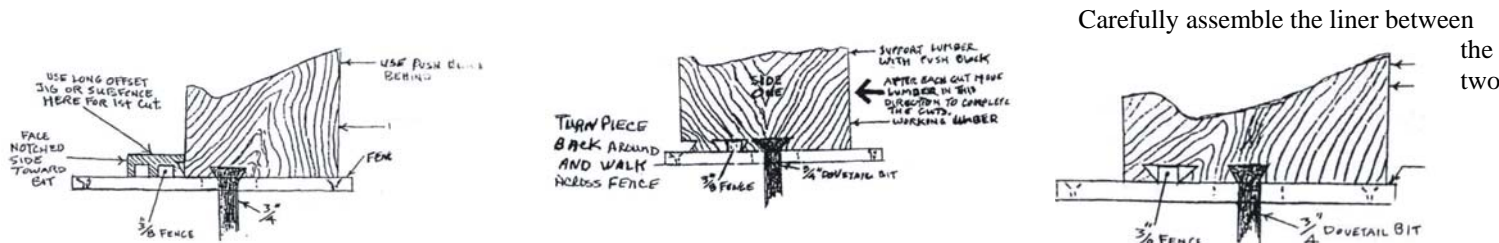

outside boards and glue in place. This technique is used to produce drawer joints, sliding dovetails and end to end fancy joinery.

The Spacer fence system can not make a half blind joint. It will make through dovetails and end to end dovetails with relative ease.

Wooden Hinges

A loose fitting box joint can be turned into a functional wooden hinge by bull nosing the end of the boards before cutting the box joint and drilling the completed joint to accept a dowel pin as a pivot.

