



UNEK AUTOMATION

Auto-Mate Gate Automation Kit Installation Instructions

Pegasus Series



Please Read First



WARNING: It is vital for everyone's safety that you follow all instructions. Failure to comply with the installation instructions and the safety warnings may result in serious personal injury and/or property and automation kit damage. Please save these instructions for future reference.

Uneek Technologies Pty Ltd to the extent that such may be lawfully excluded hereby expressly disclaims all conditions or warranties, statutory or otherwise which may be implied by laws as conditions or warranties of purchase of a Uneek Technologies Pty Ltd Gate Opener. Uneek Technologies Pty Ltd hereby further expressly excludes all or any liability for any injury, damage, cost, expense or claim whatsoever suffered by any person as a result whether directly or indirectly from failure to install the Uneek Technologies Gate Opener in accordance with these installation instructions.

Important Safety Rules

- ⇒ Installation of the Auto-Mate Gate Automation Kit requires the use of various hand and power tools. It is recommended that installation is carried out by someone with sufficient knowledge and experience to install the kit correctly. Serious personal injury and/or property damage can result from failure to follow this warning.
- ⇒ DO NOT operate the gate opener unless the gate is in full view and free from objects such as cars and children/people. Make sure that the gate has finished moving before entering or leaving the driveway.
- ⇒ DO NOT operate the gate opener when children/people are near the gate. Children must be supervised near the gate when the gate opener is in use. [Serious personal injury and/or property damage can result from failure to follow this warning.](#)
- ⇒ DO NOT allow children to operate the gate opener. Serious personal injury and/or property damage can result from failure to follow this warning.
- ⇒ Make sure that the Safety Obstruction Force system is working correctly and is tested every month.
- ⇒ DO NOT disengage the swing gate opener to manual operation with children/people or any other objects including motor vehicles within the gateway.
- ⇒ The gate opener should not be immersed in water or sprayed directly by a hose or other water carrying device.
- ⇒ The gate(s) must be well balanced and in good working order. Faulty gates must be repaired by a qualified technician prior to opener installation.
- ⇒ 240v openers must be plugged into a properly earthed general purpose 240V mains power outlet installed by a qualified electrical contractor.
- ⇒ Disconnect the power cord from mains power before making any repairs or removing covers. Only experienced service personnel should remove covers from the gate opener.
- ⇒ Always keep hands and loose clothing clear of the gate and opener.
- ⇒ It is highly recommended that a Photo Electric Beam be fitted correctly and tested for operation at regular intervals. Extreme caution is recommended when using Auto-Close mode. All safety instructions above must be followed.
- ⇒ In order for the gate opener to sense an object obstructing the gateway, some force must be exerted on the object. As a result, the object, gate and/or person may suffer damage or injury.
- ⇒ Frequently examine the installation and mountings for signs of wear, damage, or imbalance. DO NOT use if repair or adjustment is needed since a fault in the installation or an incorrectly balanced gate may cause injury.

Features

The Auto-Mate gate automation kit has been designed and built by Uneek Automation using the best components available in Australia. The components used in this kit are tried and tested in the Australian market and have been chosen due to their quality and performance in our harsh environment.

The kit consists of one or two 24 volt DC Heavy Duty Drive Units, sealed control box, AGM batteries, solar panel including bracket, two remote controls and all required cables and fixings for a standard install.

DRIVE UNIT

The Drive Unit/s are powered by a heavy duty 24V DC motor driving full metal gears with cam activated limit switches. The unit features a quick release pin that will release the gate to swing freely for emergencies. Simplicity, quality components and robust construction combine to deliver a world leading automation drive unit.

INTELLIGENT CONTROL BOARD

Featuring the Eclipse operating system, the control board is a user-friendly menu driven system that uses a 1-touch button to control, setup and run the gate kit. It uses a large 4-line LCD screen showing live reading of the motor performance and status of all inputs and outputs. All kits will be supplied with the control board pre-configured for your selected accessories.

CONTROL BOX

The Control Box is a powder coated full metal construction enclosure that contains the control board, batteries, solar charge controller and any other optional accessories. Our control box is key lockable and fully sealed to ensure no moisture or unwanted guests take up residence (ants, spiders etc.).

Features

SOLAR PANEL

The kit is supplied with an 'A Grade' 20 watt solar panel and fully galvanised bracket.

CHARGE CONTROLLER

The solar charge controller integrates efficient PWM charging to increase battery life and improve system performance. With a simple interface for ease of use, this controller comes equipped with fully comprehensive self-diagnostics and electronic protection functions to prevent damage from installation mistakes or system faults.

REMOTE CONTROLS & RECEIVER

All kits are supplied with two 4 channel remote controls featuring code hopping technology that consists of over 4.29 billion different codes. This technology ensures maximum security and makes it almost impossible to duplicate and open the gate.

Remote controls will come pre-programmed with:

Button 1 – Open – Auto Close will be engaged at 15 second delay.

Button 2 – Open – Stay Open – Button 2 needs to be pressed to release the gate and auto close.

Optional programming (Please contact us for instructions on how to set up these options).

Button 3 – Pedestrian access – Gate will partly open and auto close after 10 seconds.

Button 4 – Lock – This will lock out all other inputs. Keypads, Pushbuttons and GSM kits will not open the gate

Options

240V MAINS POWER

The 240V option comes with a quality AC to DC charger to keep the batteries charged. Battery backup is standard on all kits. You will never be stuck behind the gates if the power goes out.

LOW VOLTAGE VIA 240V MAINS

Low voltage will allow the kit batteries to be charged via 240v mains plug up to 20meters away. We will supply the charger and low voltage cable required. Being low voltage, the cable doesn't need to be installed by an electrician and can be run to the gate kit at any depth below the surface. We have options for longer cable runs, please contact us directly for pricing if required.

WIRELESS VISITOR BUTTON

An optional wireless visitor button can be mounted on a post or wall (anywhere really). This will allow access via the push of a button. The push button can be disengaged via a key.

WIRELESS VISITOR KEYPAD

An optional wireless visitor KEYPAD can be mounted on a post or wall (anywhere really). This will allow access via a 4 digit code.

ADDITIONAL REMOTE CONTROLS

Up to 30 additional remote controls can be added to any gate kit.

DAY/NIGHT SENSOR

A Day/Night sensor can be added to allow the gate kit to open/close the gate at dusk or dawn.

Options

PHOTO ELECTRIC SAFETY BEAM

A high-quality Photo Electric Sensor stops the gate closing if a vehicle or person is in the gateway. (Great for large trucks, farm machinery, horse floats etc.). Highly recommended for any gate with auto close active.

OPERATIONAL TIMER – OPEN/CLOSE OR LOCK/UNLOCK

A timer can be added to open or close the gate at pre-set times. Alternatively, the timer can control locking or unlocking of additional inputs such as visitor buttons, or keypads.

COURTESY LIGHTS

An optional LED light can be fitted to light up the gate area during opening and/or closing of the gate.

STROBE LIGHT

A strobe light can be added to warn that the gate is opening and closing.

BLUETOOTH BATTERY MONITOR

Optional Bluetooth module available to deliver real time energy data via a smart phone app.

Initial Check

Our Auto-Mate gate kits have been designed to operate the vast majority of residential and farm gates. To ensure a successful install, its important that the gates are in good working order and move freely without binding, sticking or touching the ground during either opening or closing.

Wind loading is an important consideration when assessing the safe and effective operation of your gate automation kit and may adversely effect the gate automation kit in high wind areas.

Pre-installation Inspection

Before commencing installation, check the following:

1. The gate moves freely by hand for the full length of open and close travel.
2. The pier or post for mounting must be of solid construction (Brick, solid timber or steel). It will bear most of the force applied by the drive unit.
3. The gate end rails are vertical, and the gate bottom is straight and horizontal.
4. On a single gate install, the gap between the post and the gate must not exceed 75mm. If the gap exceeds 75mm a spacer will be required.
5. On a double gate install, the gap between the gates must not exceed 100mm.
6. Double gates require a centre stop. Please ensure a centre stop is installed. The clearance from the bottom of the gate to the driveway must not exceed 60mm. If the gap exceeds 60mm an extension can be attached to the gate to reach the centre stop.
7. If the gate kit is to operate off mains power, a weatherproof 240V 10A general purpose power point should be available within one metre of the pier/post.
8. Ensure side room clearance is adequate. Refer to Table on **page 9**.

Installation - Pre Installation—Pegasus Series

Step 1—Pre Installation Measurements

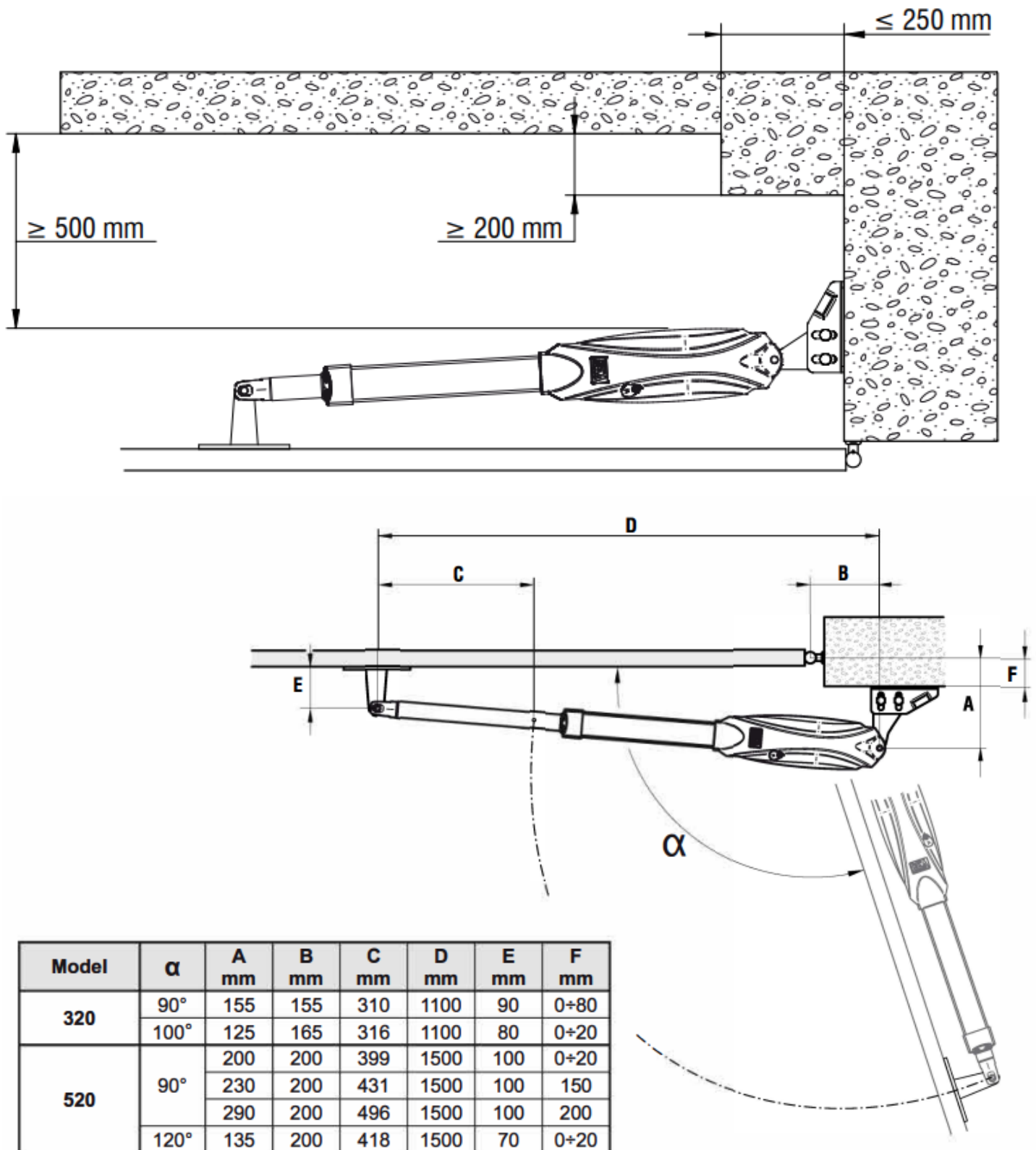

The mount distance for the drive unit and the hinge distance for the gate can be selected to optimise the side room clearance.

NOTE: If the gate is already installed, measure the hinge distance and use this table to optimise the mount distance.

Installation - Pegasus Series

Step 2—Drive Unit Installation

Note: If mounting onto round posts, ensure enough material is removed to allow flat mounting of drive unit.

Post/Pillar Motor Mounts

If installing the motors onto wooden posts, use the supplied coach screws. If installing into concrete or onto metal posts please use the appropriate fixings available from any good hardware store. We recommend a minimum of M10 fixings. Mounts may be welded onto metal posts or gates if preferred.

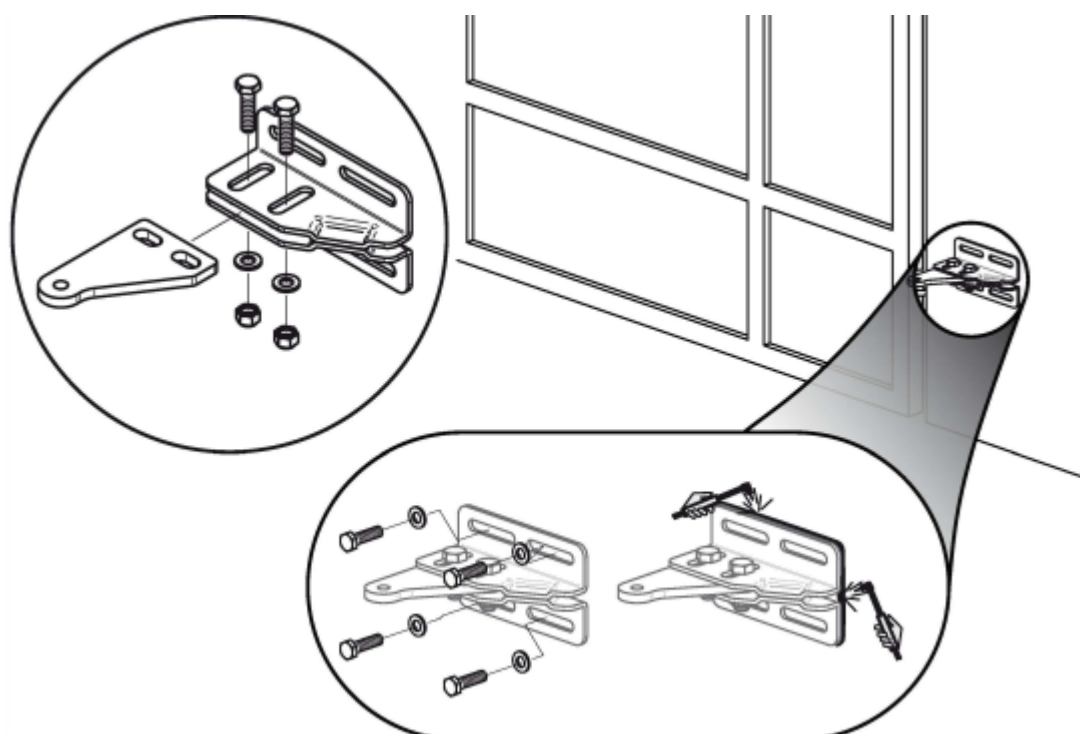

Gate Motor Mounts

We recommend bolting the gate motor mounts onto the gates. If the gates are metal, you can weld the gate motor mount if preferred. (Bolts not provided).

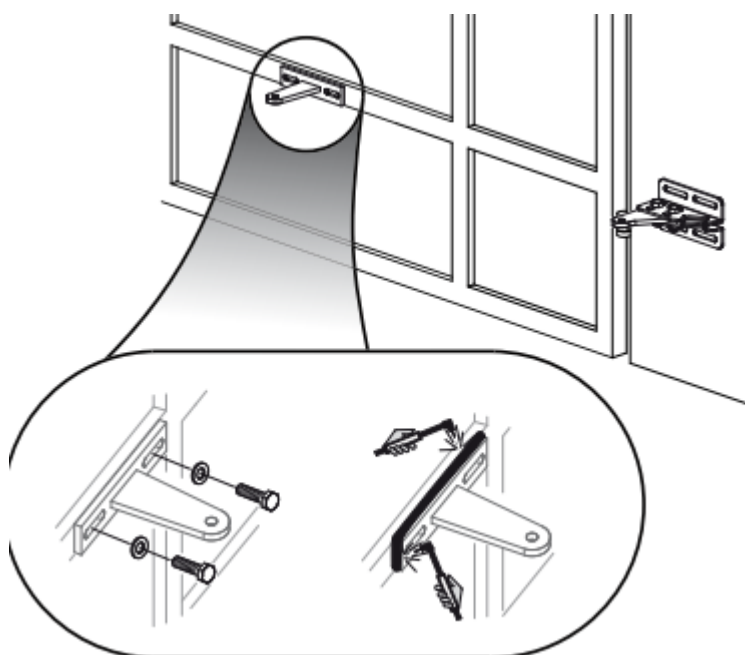

Installation - Pegasus Series

Mounting the motors

Lift the motor into place and secure with the provided pin & circlip.

Don't let the weight of the motor hang on either motor mount. Ensure both mounts are securely fastened before operation.

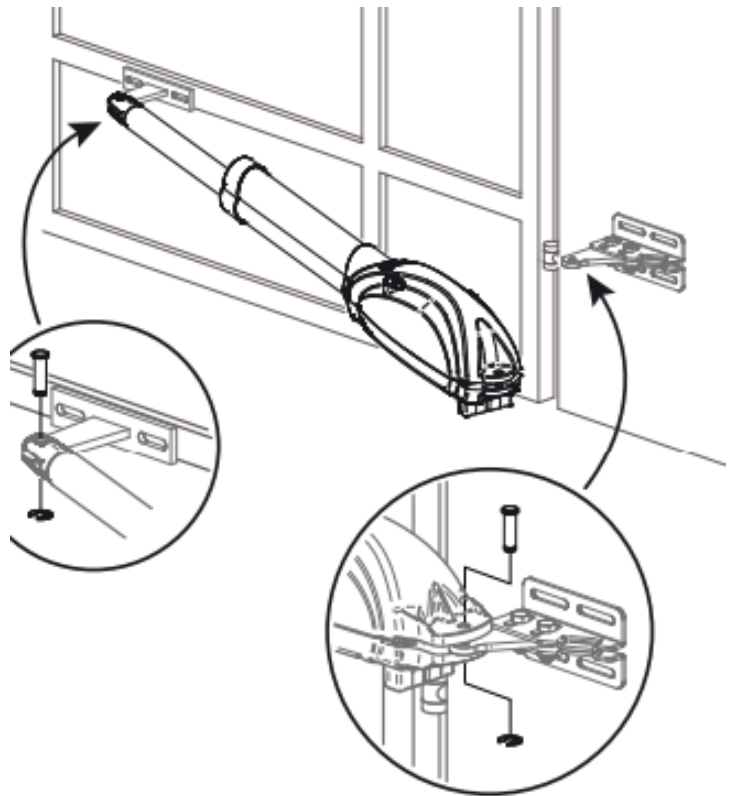

Manual Release

Insert the motor key provided and turn to release the motor. Turn back to reengage the motor.

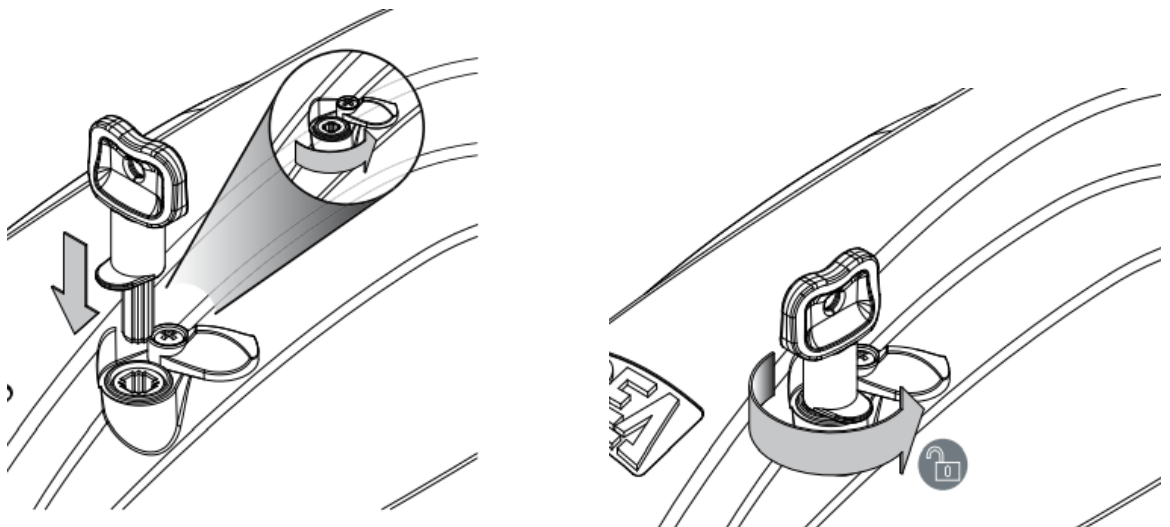

Installation - 2nd Drive Cabling

Step 4—2nd Drive Cabling—Double Gates Only

On all double gate automation installs, it's necessary to run the drive unit control cables across the driveway to the second drive unit.

Gravel/Dirt Driveways

- ⇒ Dig a channel across the driveway from the control box to just below the second drive unit. Channel should be 100mm deep x 100mm wide (Minimum).
- ⇒ Lay in-ground rated solid conduit in the channel (Orange 25mm solid conduit is ideal).
- ⇒ Run the supplied 5 core cable from the control box to the second drive unit.
- ⇒ If you have selected safety beam sensors as an option for your kit, run the safety beam sensor cable in the same conduit.
- ⇒ If you have any other options that you want to run on the other side of the driveway (Flashing light, courtesy light etc.) run through the same conduit.

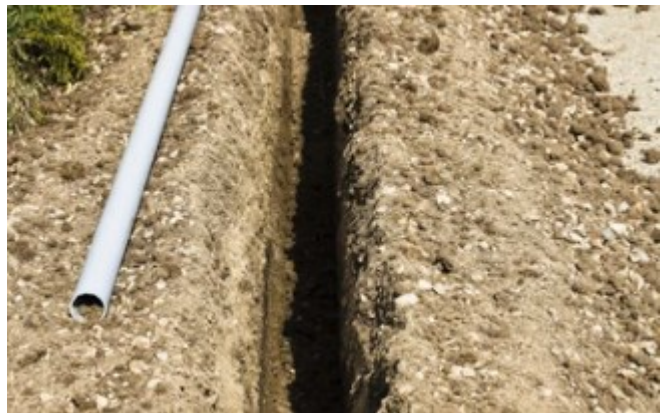

it

Concrete/Asphalt Driveways

- ⇒ Using the appropriate saw (concrete or asphalt blade) cut a channel across the driveway a minimum of 5mm wide and 10mm deep.
- ⇒ Run the supplied 5 core cable from the control box to the second drive unit.
- ⇒ If you have selected safety beam sensors as an option for your kit, run the safety beam sensor cable in the same cut across the driveway.
- ⇒ If you have any other options that you want to run on the other side of the driveway (Flashing light, courtesy light etc.) run through the same cut in the driveway.
- ⇒ Once all of your cables are inserted in the cut, reseal the driveway using the appropriate sealer.



it

Installation - Centre Stop

Step 5—Centre Stop—Double Gates Only

A solid centre stop is required for all double gate installs.

- ⇒ Close the gates to determine the best closing position for both gates. Mark where the centre stop is to be positioned

Gravel/Dirt Driveways

- ⇒ For gravel or dirt driveways, dig a hole 200mm deep and 300mm x 300mm wide
- ⇒ Mix up enough concrete to fill the hole creating a flat stable bed for the centre stop to sit on.
- ⇒ There are several ways to fix the centre stop into the concrete:
 - ⇒ 1. Use 3x 120mm M12 Galvanised bolts. Using a nut and bolt, affix the bolts through the centre stop and bed these into the wet concrete. Ensure the stop is perfectly aligned before the concrete sets.
 - ⇒ 2. Lay a bed of concrete in the hole and allow to fully set. Mark and drill holes and use M12 size dyna bolts to affix centre stop to concrete pad.
- ⇒ Once the centre stop is in place, you can now fill in and compact the channel in the driveway.

Concrete/Asphalt Driveways

- ⇒ Mark the ideal position of the centre stop
- ⇒ Drill holes to receive M12 Dyna bolts
- ⇒ Bolt down centre stop.



Installation - Control Unit

Step 6—Mounting Control Unit

The control unit can be mounted anywhere within 5mt (ideally within 0.5mt to 1.0mt) of the drive unit on the hinge side of a single gate. On double gates, the control unit can be mounted on either side. Be mindful that the solar panel should be mounted on the same side as the control unit. Ideally the control unit should be mounted a minimum of 300mm off the ground. Ensure that the Control Unit isn't in the way when the gate opens.

- ⇒ Select the ideal position to mount the control unit.
- ⇒ The ideal location will allow all 4 corners of the control unit to be securely fixed.
- ⇒ 2mt of drive unit cable is provided for single gate installs and 8 mt for double gate installs.
- ⇒ Use a spirit level to ensure the control unit is level
- ⇒ Open the control unit and use the provided fixings to secure the control unit through the 4 holes in the back of the control unit.
- ⇒ If mounting the unit to a surface other than wood, please select appropriate fixings for that surface.
- ⇒ Once mounted, apply a thin layer of silicone to the fixings to ensure a waterproof seal.
- ⇒ Run the drive unit cables into the control unit via the conduit glands in the base of the control unit. Use the flexible conduit provided to ensure a neat and more importantly water-tight seal.
- ⇒ Connection of the wires will be covered in a later section of the installation manual.



Installation - Solar Panel

Step 7—Mounting Solar Panel

The solar panel should be mounted in a location that receives a minimum of 5 hours sun. Facing the panel due north will deliver the best results. Any amount of shading on the panel will significantly reduce the output of the panel and needs to be avoided. Typically, a post located within 2mt of the control unit is the ideal location.

- ⇒ Select the ideal position to mount the solar panel.
- ⇒ The ideal location will deliver a minimum of 5 hours sun each day.
- ⇒ Assemble the solar panel and bracket using the 4 Phillips head bolts and nyloc nuts provided. A Phillips head screw driver and 12mm spanner are required.
- ⇒ Secure the lower section of the solar panel pole (Square section) to the desired location using the supplied 100mm coach screw. Screw through the lowest pre drilled hole.
- ⇒ Insert the round section of the post into the square section and push down. Orient the panel to due north using a compass (Compass apps are available online).
- ⇒ Using the upper 2 pre drilled holes, drill all the way through the round post with a 6mm drill bit. Secure using the 2 remaining coach screws.
- ⇒ Screw the 2 provided Tek screws through the remaining pre drilled holes on the sides of the square section.
- ⇒ Once mounted, run the solar cable through or alongside the panel bracket pole.
- ⇒ Using the cable clips provided, run the cable along the fence back to the control unit.
- ⇒ Run the cable into the control unit via the left hand cable gland located underneath the control unit (Use supplied clips or run through flexible conduit (Not supplied)).
- ⇒ Wiring will be covered in a later section of the installation manual.



Installation - Wiring

Step 8—Drive Unit Wiring

All wiring must be completed in the order listed below. Failure to do so may cause damage to the unit and void the warranty.

Drive Unit Wiring

- ⇒ The drive unit wiring consists of a single cable containing 5 cores of coloured wires (Red, Yellow, Green, White & Brown).
- ⇒ Red & Yellow—Drive unit Power
- ⇒ Green—Open Limit Switch
- ⇒ Brown—Close Limit Switch
- ⇒ White—Limit Switch Common
- ⇒ Remove the screws from the underside of the drive unit and gently pull out the electrical mounting block.
- ⇒ Strip 30mm of the outer cover of the 5 core cable
- ⇒ Strip 5mm of the outer cover off all 5 wires
- ⇒ Wire the drive unit as listed below:
 - ⇒ Red— OPEN
 - ⇒ Yellow— CLOSE
 - ⇒ White— COM
 - ⇒ Brown— FCC
 - ⇒ Green— FCA

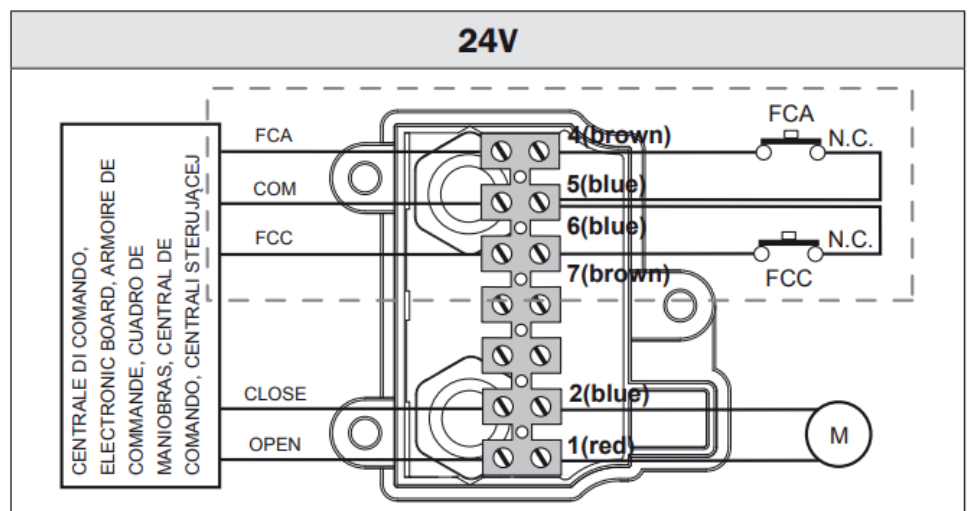

- ⇒ Insert the wires into the correct terminal and firmly screw down the terminal.
- ⇒ Repeat the wiring on the second drive unit for double gates.
- ⇒ Run the cable to the control unit.

Installation - Wiring

Step 9—Drive Unit Wiring to Control Unit

- ⇒ Strip 30mm of the outer cover of the 5 core cable
- ⇒ Strip 10mm of the outer cover off all 5 wires
- ⇒ Insert Motor 1 power wires (Red & Yellow) into the corresponding terminals as marked on the control board (Motor 1 is closest to the control box in a double gate setup). Polarity is not important, either way will work fine. Tighten the terminals. (Repeat for Motor 2 in a double gate setup).
- ⇒ Insert the Green wire into the terminal marked "Open M1 Limit" (Repeat for Motor 2—"Open M2 Limit" in a double gate setup).
- ⇒ Insert the Brown wire into the terminal marked "Cls M1 Limit" (Repeat for Motor 2—"Cls M2 Limit" in a double gate setup).
- ⇒ Insert the white wire into the terminal marked "COM" (Both white wires are inserted into the same "COM" terminal for a double gate setup).

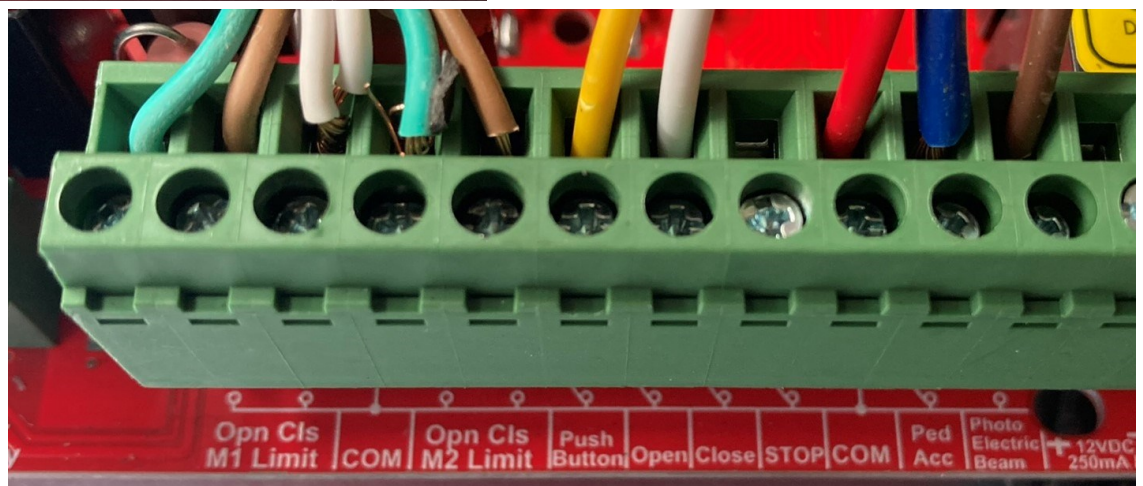
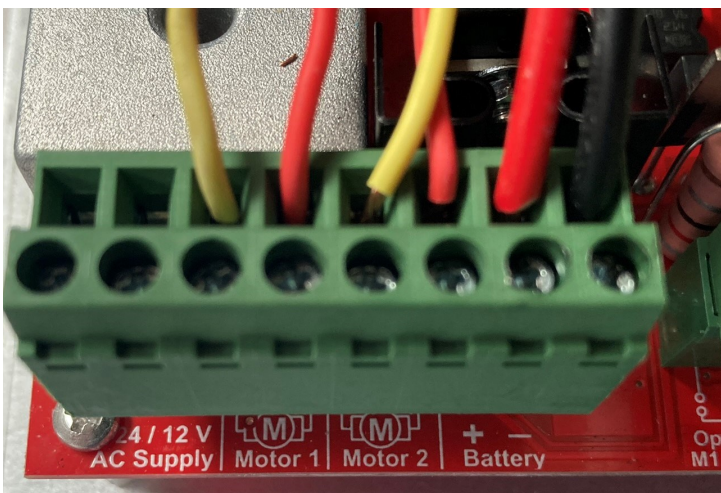

Installation - Wiring

Step 10—Battery Wiring

Battery Wiring

- ⇒ Place both batteries into the control unit in a stand up position and the terminals at the top facing you.
- ⇒ Connect the spade terminals onto the batteries taking care to match the colours of the wires to the terminals.
- ⇒ There may be a small spark as you connect the terminals, this is normal. The unit is polarity protected and will not operate if the wiring is installed incorrectly.
- ⇒ The control unit will activate and an audible beep will be heard as the unit power up, this is normal.



Installation - Wiring

Step 11—Wiring for Solar Panel

- ⇒ Strip 5mm of the outer cover off both wires
- ⇒ Locate the grey terminal plug inside the control box (Grey terminal plug with red and blue lock terminals (Shown below)).
- ⇒ Lift the locking arms up on the terminal side not containing wire (There can be quite stiff).
- ⇒ Twist the wire tightly before inserting into the plug terminals.
- ⇒ The plug is marked with Red & Blue Terminals. Insert the red wire into the red terminal and the black wire into the blue terminal.
- ⇒ Push the red and blue locking arms down to secure the wires.
- ⇒ Check the Renogy controller by pushing select. You should see the panel producing power (Both Voltage and Amps). The amount of power will vary greatly depending on the amount of sun.



Wiring is now complete.

IMPORTANT: Progress to setting up the gate travel before engaging the gates.

Setting Up the Gates

Step 12—Gate Travel Limits

- ⇒ Our Auto-Mate kits use physical limit switches to determine the stop points on both open and close cycles. It is imperative that these limits are set before activating the gates.
- ⇒ The limits are activated by a set of mechanical switches located in the drive units, these switches are set by winding in or out the set screws found at the front of the drive units.

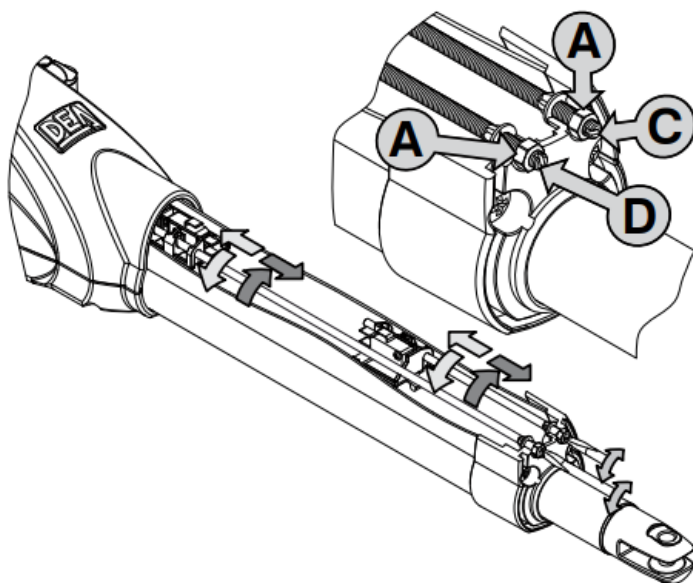
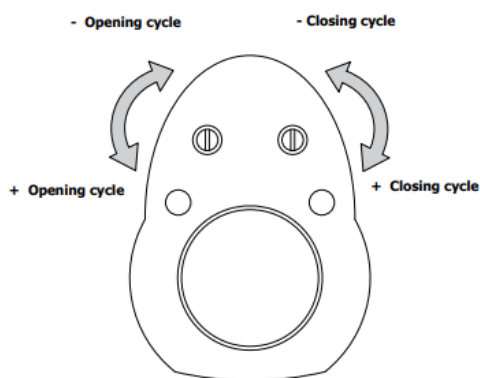

- ⇒ Remove the 2 covers found at the top of the drive units. Inside you will see the mechanical limit switches. Release the locking nuts and wind in or out the limit switches. If you look inside when winding you will see the limit switch moving up and down the length of the drive unit body.
 - ⇒ Once set, apply a small amount of silicone to the cover to ensure water doesn't enter the drive unit body.

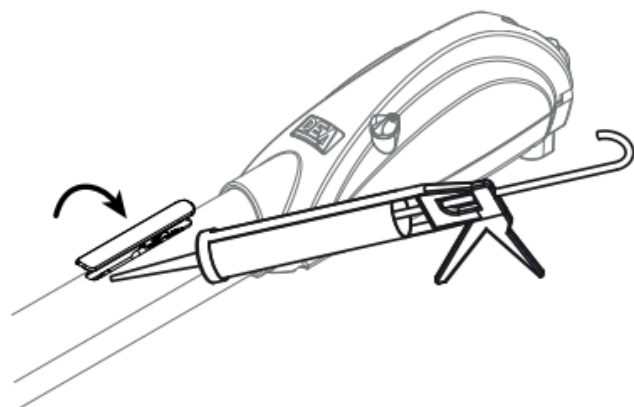
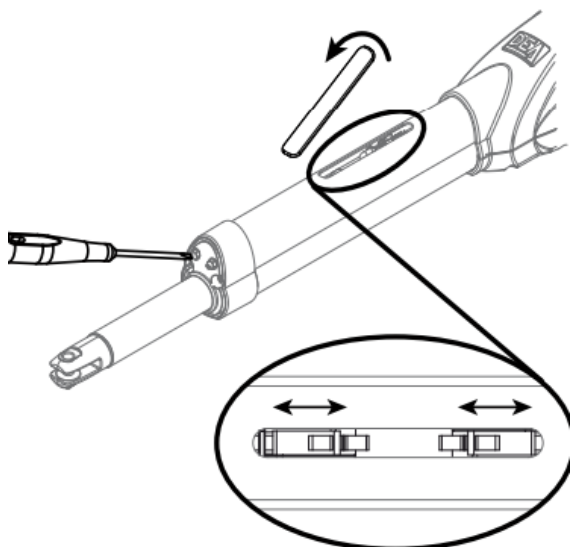

Setting Up the Gates

Step 12—Gate Travel Limits

- ⇒ All of our Auto-Mate gate kits use the highly intelligent Eclipse Operating System. This system allows quick and simple setup of any gates.
- ⇒ To enter programming press and hold the control knob for 2 seconds, The system will beep to confirm that you have entered programming mode.



- ⇒ Turn the programming knob clockwise until you see menu 16.0 TOOLS press the knob once.

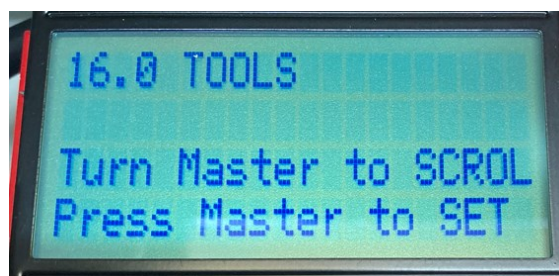

- ⇒ Turn the programming knob clockwise until you see menu 16.4 Test Inputs. Press the knob once.
- ⇒ In this screen you can test all of the gate inputs.

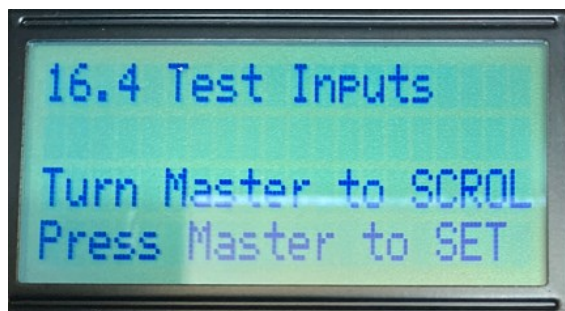

- ⇒ Put the gate in manual mode.
- ⇒ Move the gate between open and close, when the limit switch is triggered, the system will “beep” and the m1oplmt (motor 1 Open Limit), m1clslmt (Motor 1 Closed Limit), m2oplmt (Motor 2 Open Limit) or m2clslmt (Motor m2 Closed Limit) will move from lower case to UPPER CASE. If the limit doesn't trigger, you may need to move the limit switch either forward or backwards until it triggers



Setting Up the Gates

Step 13—I Learning Procedure

- ⇒ Turn the knob clockwise until you see Menu 13. Press the control knob to enter i-Learning mode. The system will now ask you a list of questions to confirm the gate setup:

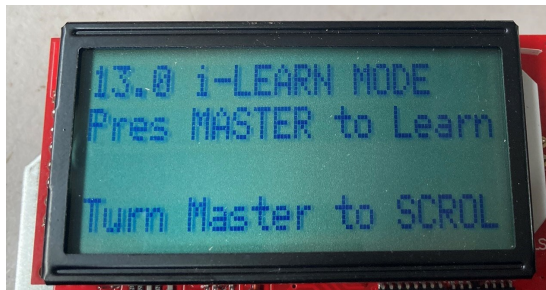

- ⇒ Single or Double Gates—**Choose the setup you have**

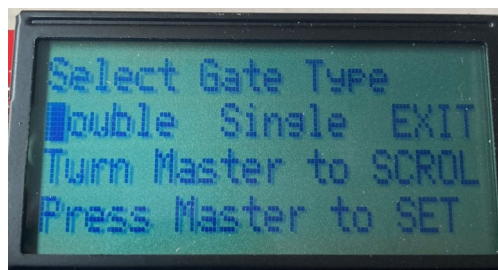

- ⇒ Are Limit Switches used—**Yes**

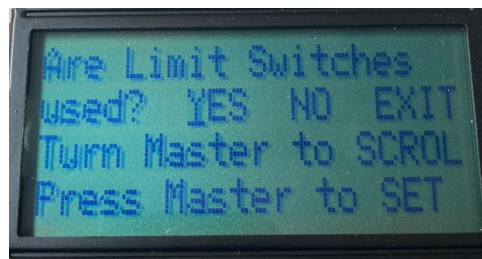

- ⇒ How are the limit switches connected? - **MC Control Card**

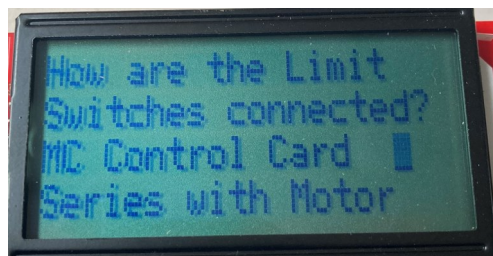

- ⇒ Limit Switch Input—**NC**

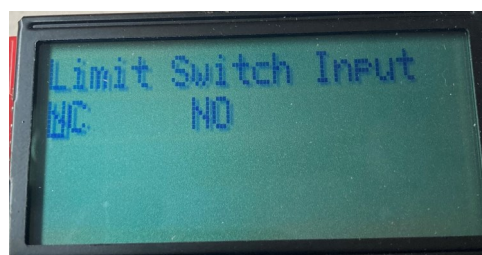

Setting Up the Gates

Step 13—I Learning Procedure Cont.

⇒ Limit Sw Operation—Gate STOPS on limits

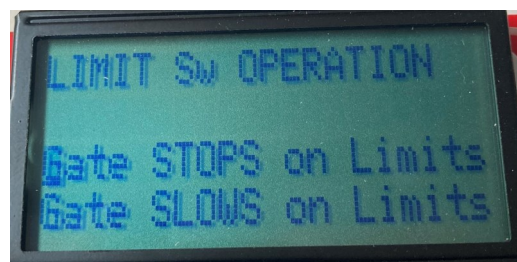

⇒ Are the gates open half way—Answer yes if they are. If not answer no and follow prompts to open half way.

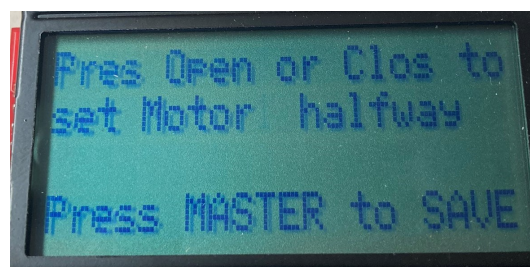
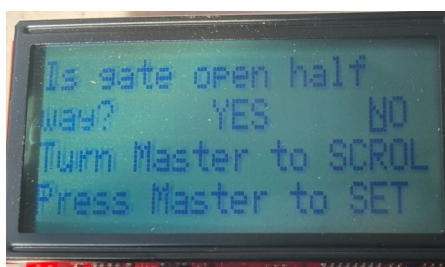

⇒ The system will now test the direction of the gate travel

⇒ Did Gate 1 Open? - Yes if it did, no if it closed. (Repeat for Gate 2 in a double gate system.

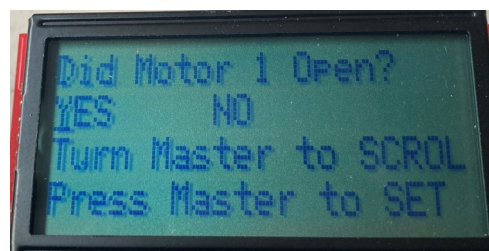
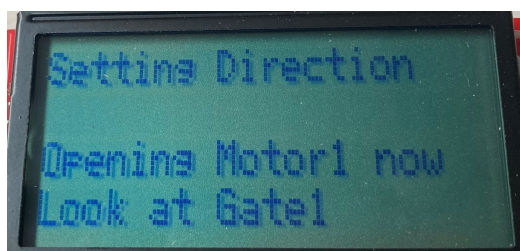

⇒ The system will now learn the limits and slow down points.

⇒ Once complete you will hear an audible beep.

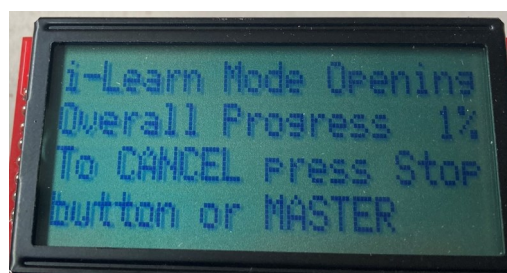

Setting Up the Gates

Step 14—Fine Adjustment

- ⇒ Once the unit has completed setup you can complete the fine adjustment.
- ⇒ Take note of how the Gate/s are opening and closing. You want the gate/s to close firmly without putting overdue stress on the gate or mountings.
- ⇒ You may back off or advance the limit switches slightly to increase or decrease the opening or closing positions.
- ⇒ Once you are happy with the opening and closing positions, tighten the locking bolt

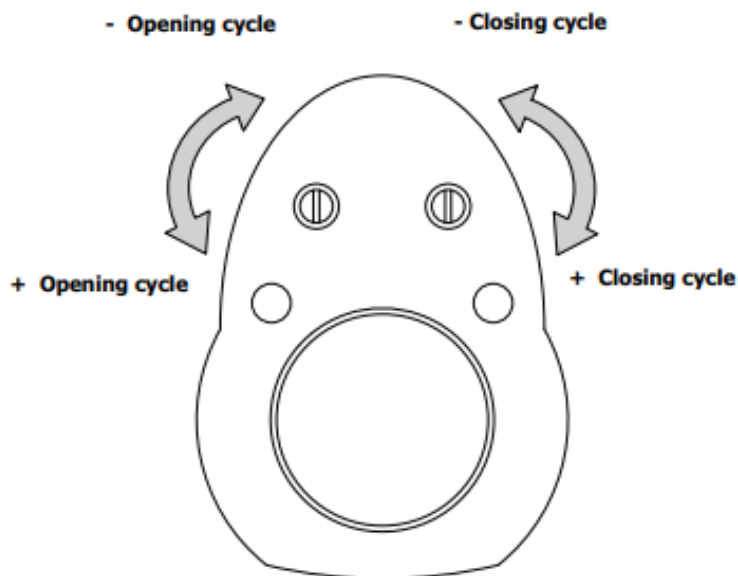

Control Board Features

- ⇒ The Eclipse Operating System comes packed with many additional settings and features. Your kit has been supplied set up and ready to use for your selected options, there are however several features you may want to adjust based on your individual requirements.
- ⇒ Several of the most common features are listed below. If you would like to make additional adjustments we recommend you read the full manual found on the Elsema website: <https://www.elsema.com/wp-content/uploads/mc-manual.pdf>
- ⇒ We recommend you familiarise yourself with the features you would like to adjust before making any changes.

8th Edition

Double & Single Gate Controller
with Eclipse® Operating System (EOS)

**Eclipse®
MC**

MC : Controller for Double and Single Gates
Setup and Technical Information
Includes latest Intelligent Technology

ELSEMA
GATE & DOOR CONTROLS
www.elsema.com

Disclaimer & Warranty

1. Uneek LEDs warrants each new product sold to be free from defects in material, workmanship and construction.
2. Where the products are installed by Uneek LEDs or its servants or agents, Uneek LEDs warrants that the products will be installed with all due care and skill.
3. Uneek LEDs will not be liable to repair or replace products which are:
 - 3.1. Misused;
 - 3.2. damaged during installation where such installation is not carried out by Uneek LEDs or its employees, servants or agents,
 - 3.3. damaged by the purchaser or user, or by livestock belonging to the purchaser or user
 - 3.4. used in a manner which is inconsistent with the instructions provided by Uneek LEDs and/or shown on the website operated by Uneek LEDs at www.uneekleds.com.au ("the website").
 - 3.5. damaged by unusual weather conditions, extremes of temperature or acts of God
 - 3.6. disassembled, tampered with or repaired by the purchaser or by any person doing so at the purchaser's express or implied request
 - 3.7. damaged as a result of exposure to dirt or corrosive substances
4. Uneek LEDs will not be liable for additional damage arising from failure to report any issue to Uneek LEDs in a timely manner;
5. Uneek LEDs will not replace goods where any damage to the goods is solely as a result of ordinary wear and tear.
6. In relation to products supplied by Uneek LEDs which are not goods of a kind ordinarily acquired for personal, domestic, or household use or consumption:
 - 6.1. Uneek LEDs will replace the product or repair the product without charge at Uneek LED's earliest convenience,
 - 6.2. the decision to repair or replace will be at Uneek LEDs' discretion.
 - 6.3. Uneek LEDs will exercise such discretion reasonably.
 - 6.4. Any products returned to Uneek LEDs and which Uneek LEDs is required to repair under the warranty will be returned to the purchaser at Uneek LEDs expense
7. 6.5 Uneek LEDs shall not in any event be liable for any other direct or indirect or consequential damages or injury to human or animal of any kind.
8. Where a product or a component of a product is listed on the website as being subject to a warranty for a specific period, Uneek LEDs:
 - 8.1. warrants that the product will operate as described on the website for the said period, subject to the exceptions set out in Clauses 3.1 to 3.7 above
 - 8.2. Will repair or replace the relevant product or component at Uneek LEDs' sole discretion
 - 8.3. Will exercise such discretion reasonably
 - 8.4. Will bear the cost of returning any repaired goods to the purchaser
9. The warranties set out above are subject to the provisions of Schedule 2 of the Competition and Consumer Act 2010 (Cth) ("the Australian Consumer Law"). Accordingly, where the Australian Consumer Law applies:
 - 9.1. In the event of any inconsistencies between the warranties set out above and the Australian Consumer Law, the Australian Consumer Law shall prevail
 - 9.2. any provision limiting any relevant warranty will be read down to the minimum extent necessary to render the relevant warranty consistent with the Australian Consumer Law.

Uneek LED's & Uneek Automation are trading names under Uneek Technologies. Any reference to Uneek LED's also refers to Uneek Automation.