

Planting

The biOrbAIR is designed to replicate the conditions found under a tropical forest canopy and is suitable for plants that are otherwise difficult to maintain. There are many exotic species including Orchids, Ferns, Begonia and Carnivorous plants that are ideal for their compact size and slow growing nature.

Our top-tips for successful planting

- Place any decorative ornaments or wood in the tank before adding compost or plants to help you visualise the look you wish to achieve.
- Once the compost is correctly moistened add it around your ornaments to hold them firmly in place, unusual shaped pieces may need additional wire supports hidden under the compost.
- Firm the compost into place, a change in levels can be more interesting than a completely flat layer.
- Plant smaller plants to the front and sides with higher feature plants to the rear, drawing the eye in.
- Allow room for growth and access to clean the inside of the globe.

- If you are planting epiphytic species make sure they receive additional sprays of Humidimist to help them adjust and root in their surroundings.
- Epiphytic plants such as Orchids also require additional weekly feeding with a suitable fertiliser. Please research individual plant requirements.

Visit www.biorbair.com to see our range of plants, video guide and gallery.

Maintenance

A. The misting unit - When the correct relative humidity is reached the misting unit will automatically switch off and only switch on again when the relative humidity drops below 75%. When the misting unit needs refilling the lights will flash. To refill, lift the lid and follow step 11

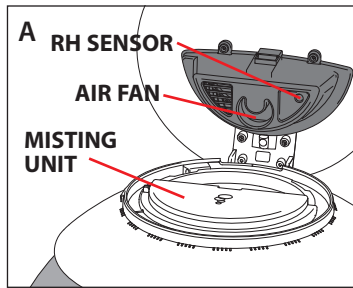

of the set-up instructions. We recommend you use the Humidimist supplied. **Do not use tap water as it will cause a build up of deposits and shorten the life of the unit.**

B. The water reservoir - The water level indicator in the base will show you when you need to top-up the water internally. To do this follow step 9 of the set-up instructions. Tap water is ok for this. **To start with monitor and top-up the water level weekly. In time your biOrbAIR will settle and require less.**

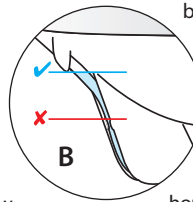

C. Changing the air filter - Every 3 months (approx.) the air filter will need to be replaced. This is done by removing

the filter cover (1), removing and discarding the old air filter cartridge (2) and replacing with a new one (3).

D. LED lights - When you turn on your biOrbAIR the lights will be low simulating a sunrise. Over 30 mins they will slowly work up to full brightness followed by 12 hours of daylight, then slowly fade over 30 mins to simulate dusk followed by 11 hours of night. This 24hr cycle will restart

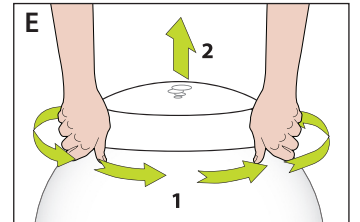
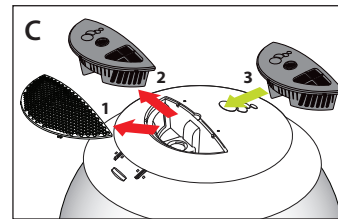

if the power is interrupted. LEDs typically last 50,000hrs and do not need replacing.

E. Removing the top - First turn off the power and unplug the cable. Rotate the whole top in an anti-clockwise direction (1) and lift off (2).

All parts and accessories can be purchased from www.biorbair.com or call 01603 710339 to talk to an advisor.

Hello.

Your biOrb Air is designed so that you can set it up easily. This guide will help you understand how your biOrbAIR works and how to create the perfect environment for your plants.



Take your time.

Please read these instructions carefully to avoid damage to your biOrbAIR. Your biOrbAIR has been carefully polished with biOrb Acrylic Polish to enhance

and protect it. **This is not a toy, adult supervision is recommended. Removing the serial number or dismantling will invalidate your guarantee.**

Caution: Do not lift by the lid. Remove the foam packing and all of the corner sections containing the parts. Check you have all the items listed on the box.

Next reach into the box, with your hands on either side, carefully lift out your biOrbAIR and remove the protective bags and **all** the protective plastic wrapping.

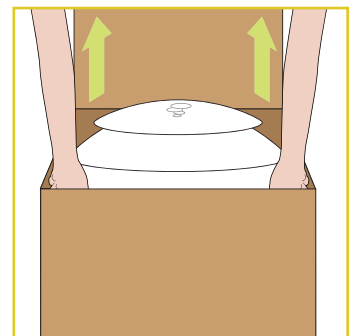
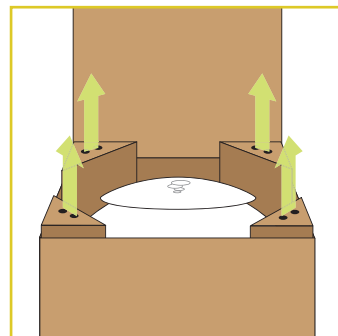
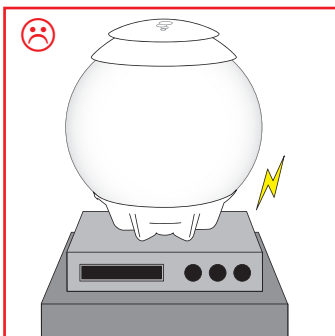

Setting up

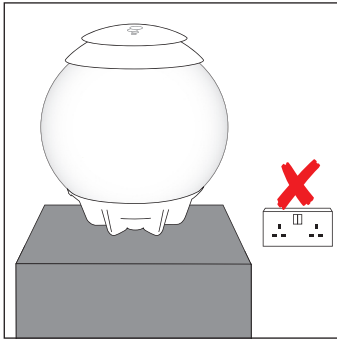

1. Place your biOrbAIR on a secure, flat surface in reach of a power socket.
Caution: Do not plug in at this stage.

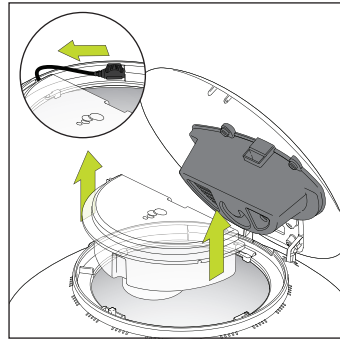

2. Lift the lid, unplug and remove the misting reservoir and put aside.

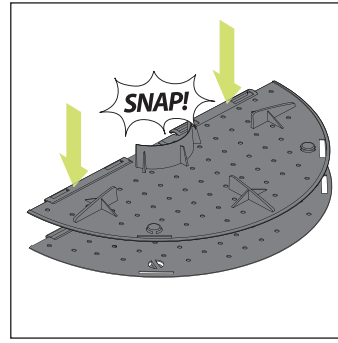

3. Remove the two support tray halves from the packing and placing them, flat face together, snap the hinges together and open out to form a large circular tray.

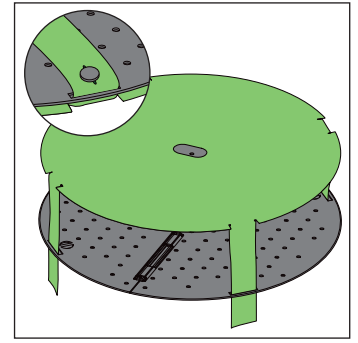

4. Fix the capillary matting to the support tray and secure onto the buttons as shown. Making sure the centre holes line up.

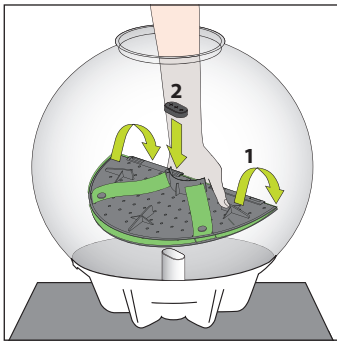

5. Fold the matting and support in half and insert into the tank, opening out with the matting on top (1). Check it's flat against the base then fit the rubber stopper supplied with the matting (2).

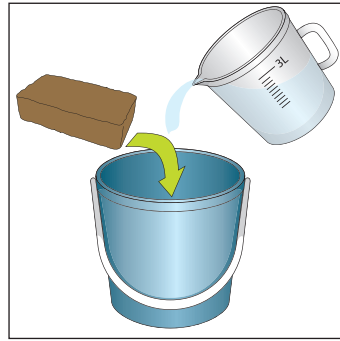

6. Place your block of coir compost into a clean container and add 2 litres (1/2 US gallon) of tap water. Allow 30 minutes for the coir to absorb the water then, if needed, gradually add more up to 1 litre.

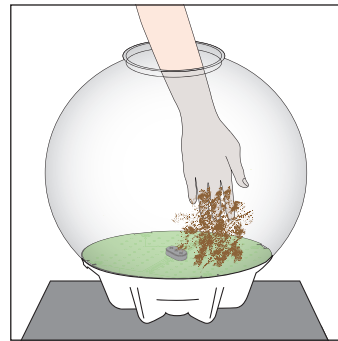

7. Now place your compost onto the support tray and firm into place. Take care to cover all the capillary matting. This will form a base for planting into.

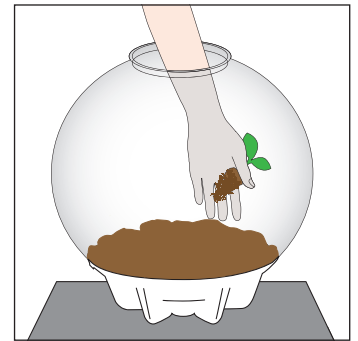

8. Now you can add your plants and decoration. Please refer to the planting guide for suggestions.

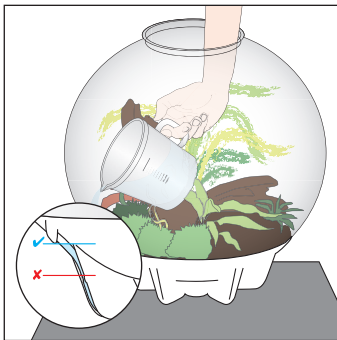

9. Slowly add half a litre of water into the base. Pour in at the inside edge of the globe as shown. Leave for 24 hours and then check the water level indicator. If necessary, slowly add more water to fill level as shown. **Caution: Do not overfill.**

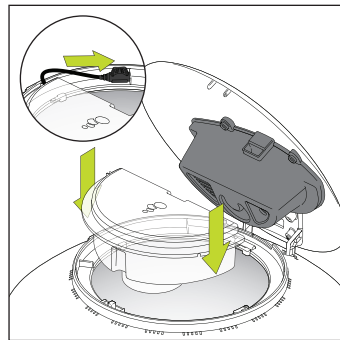

10. Place the misting reservoir back into the top of your biOrbAIR as shown. **Take care to correctly locate the reservoir and connect the plug fully into the socket in the lid.**

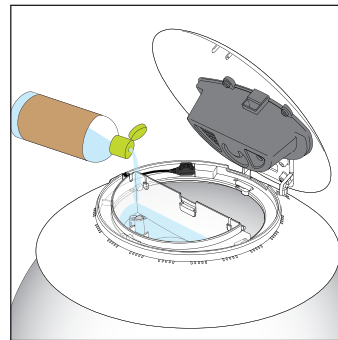

11. Remove the lid and fill the reservoir with the Humidmist (supplied) to the top of the overflow and replace the lid. **DO NOT use tap water it will shorten the life of your misting unit.**

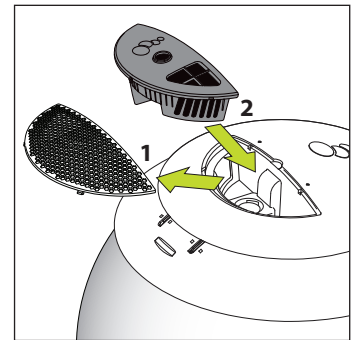

12. To install the air filter, remove the air filter cover (1), unwrap and place the air filter in the cavity (2) and replace cover.

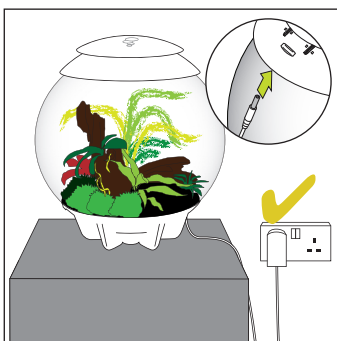

13. Carefully close the lid on your biOrbAIR. Plug in and switch on. **Note: The 24hr lighting cycle will start from the moment you plug in your biOrbAIR.**



Your biOrbAIR has automatic relative humidity and lighting control. As soon as you switch it on, the fan will circulate mist and the lights will start a 24hr cycle.

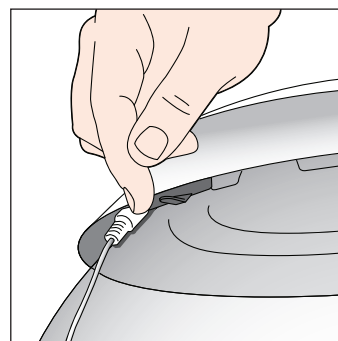

Your biOrbAIR will produce mist automatically to control relative humidity. To mist for 15 sec on demand gently touch the button at the back of the lid.



Important note: Always unplug your biOrbAIR from the mains supply before removing the water reservoir. Follow Step 10 to re-install.