



# WATERFALL WINE CELLAR KIT

## ASSEMBLY GUIDE

Page 1

Questions?  
**888.373.6057**

or visit  
**wineracksamerica.com**

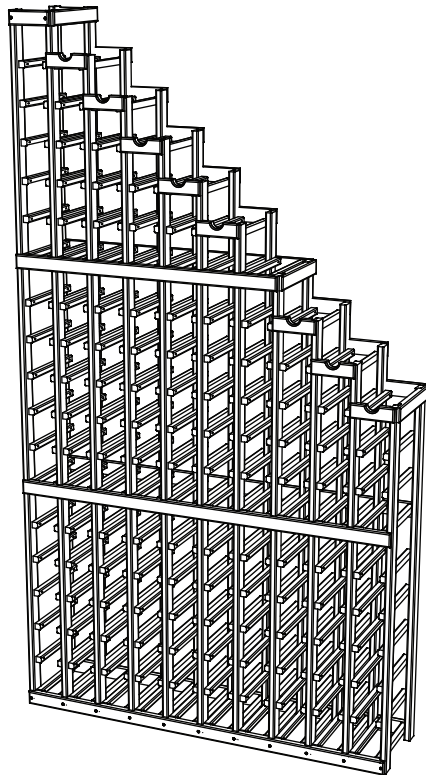

### TOOLS FOR ASSEMBLY

#### Required

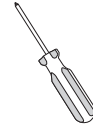

Screwdriver



Wood Glue

#### Suggested



Cordless Drill



Finish Nailer



Hammer

+



Nail Setter

### SINGLE DEEP PACKAGE CONTENTS

MIDDLE LADDER ASSEMBLIES (\*VARIOUS LENGTHS) x 9

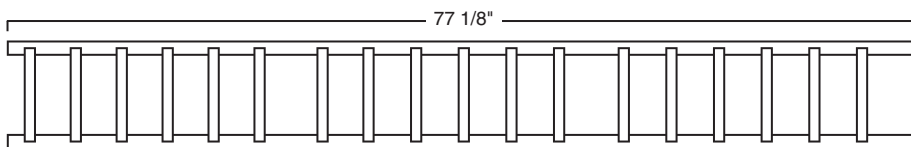

SIDE VIEW

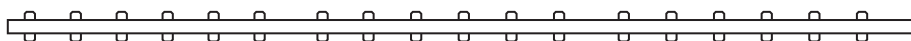

LONG LADDER ASSEMBLY (END PIECE) x 1

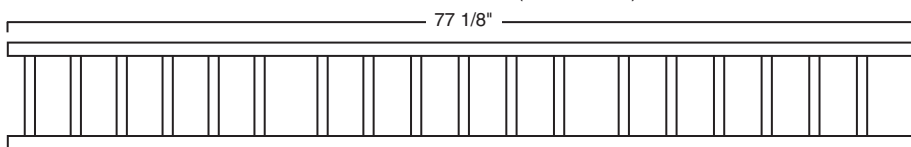

SIDE VIEW



SHORT LADDER ASSEMBLY (END PIECE) x 1

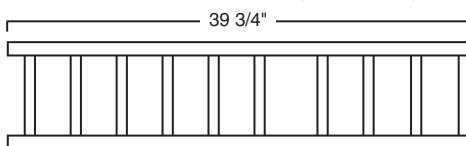

SIDE VIEW

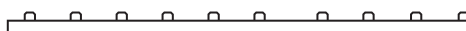

WOOD SCREWS



FINISH NAILS



SMALL BAG OF WOOD PUTTY

HORIZONTAL TRIM PIECE x 3

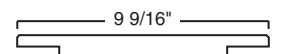

1 COLUMN CONNECTOR

SCALLOPED x 8

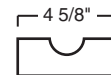

STANDARD x 10

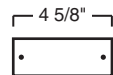

STANDARD 7 COLUMN CONNECTOR x 1

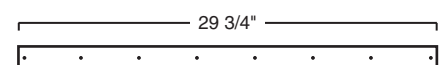

SCREWLESS 7 COLUMN CONNECTOR x 1

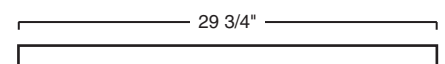

STANDARD 10 COLUMN CONNECTOR x 3

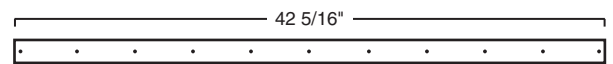

SCREWLESS 10 COLUMN CONNECTOR x 1

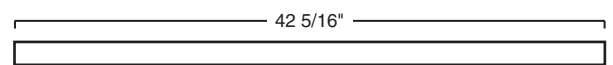



# WATERFALL WINE CELLAR KIT

## ASSEMBLY GUIDE

Questions?  
**888.373.6057**

or visit  
**wineracksamerica.com**

### DOUBLE DEEP PACKAGE CONTENTS

LONG LADDER ASSEMBLY  
(END PIECE) x 1

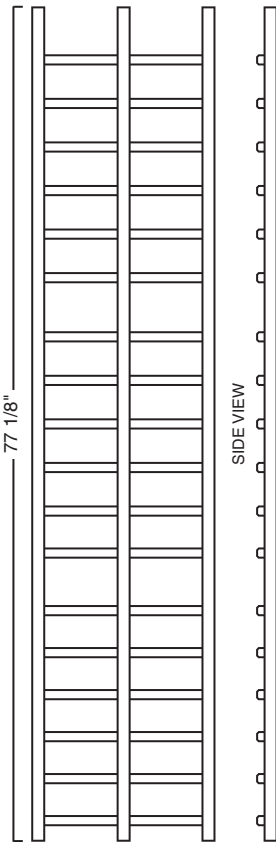

MIDDLE LADDER ASSEMBLIES  
(\*VARIOUS LENGTHS) x 9

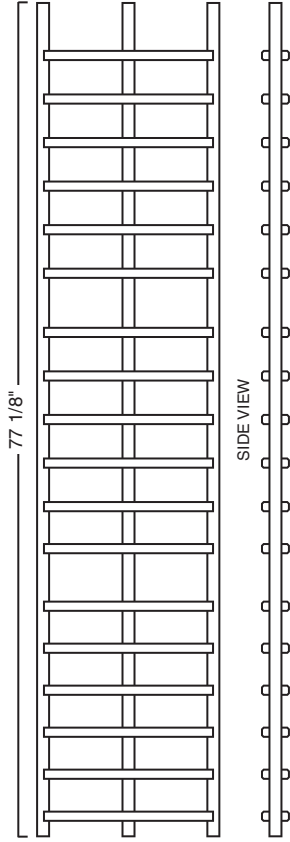

SMALL BAG OF  
WOOD PUTTY

SHORT LADDER ASSEMBLY  
(END PIECE) x 1

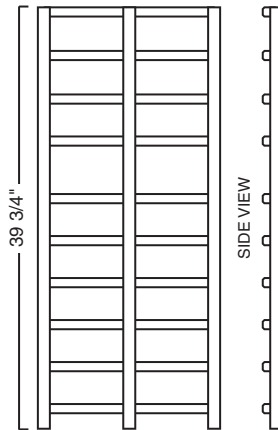

STANDARD 10 COLUMN CONNECTOR x 2

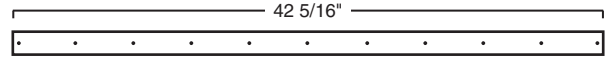

SCREWLESS 10 COLUMN CONNECTOR x 2

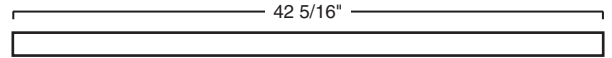

SCREWLESS 7 COLUMN CONNECTOR x 2

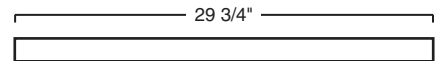

1 COLUMN CONNECTOR

SCALLOPED x 16

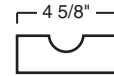

STANDARD x 2

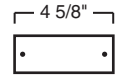

HORIZONTAL TRIM PIECE x 3

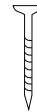
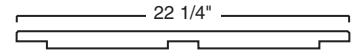

1 1/4" WOOD SCREWS



FINISH NAILS

1. Find an open, flat area in which to work. Carefully remove all components from the box and remove banding with a utility knife. Check the parts list to verify package contents
2. Arrange the ladders on the floor to form the "stair step" design pictured. **This will be the back of your rack.** The back of your rack will depend on which direction you would like the waterfall rack to descend. For example figure 1 shows the waterfall rack descending from right to left.

Arrange the long end ladder so that the large gap on the end of the ladder becomes the top of the stair steps. **This is the top of your rack.**

**\*If you are assembling the Double Deep Waterfall Rack please skip step 3 and use steps 4-6 for assembling the front and back of your rack.**

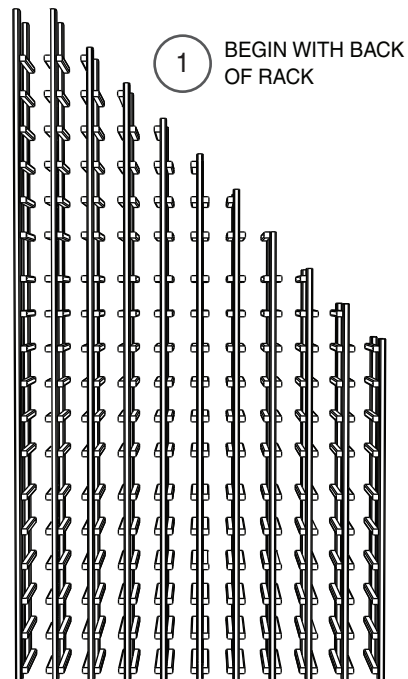



# WATERFALL WINE CELLAR KIT

## ASSEMBLY GUIDE

Questions?  
**888.373.6057**  
or visit  
**wineracksamerica.com**

Page 3

3. First attach the bottom 10 column connector using the screws provided. Make sure that the bottom of the connector is flush with the bottom of the rack. Each vertical ladder piece should fit snugly into the notches of the horizontal connector.

Next secure the middle 10 column and 7 column connectors. The top edge of the middle 10 column connector should be  $26 \frac{5}{8}$ " from the bottom of the rack, and the top edge of the middle 7 column connector should be  $51 \frac{3}{4}$ " from the bottom of the rack. (figure 2)

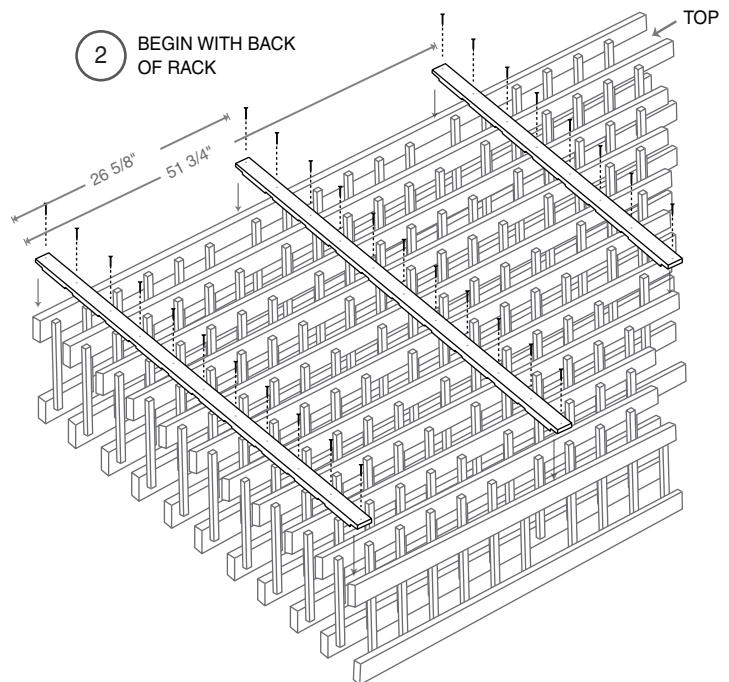

4. Flip rack over and secure a standard 10 column connector to the bottom of your rack using the screws provided. Make sure the standard connector is flush with the bottom of the rack. (figure 3)
5. Attach the middle screwless connectors so that the top edge of the middle 10 column connector is  $26 \frac{5}{8}$ " from the bottom of the rack, and the top edge of the middle 7 connector is  $51 \frac{3}{4}$ " from the bottom of the rack. Make sure the rack is flat on the floor while attaching the screwless connectors. (figure 3)

Secure the screwless connectors using wood glue and a finish nail gun to drive a finish nail through the connector into each vertical ladder. (figure 4)

If you do not have a finish nail gun, drive one of the provided finish nails into each vertical ladder until it is flush. Then, countersink the nail using a nail setter until the head of the nail is about  $\frac{1}{16}$ " below the surface of the wood.

6. Fill the nail holes using the wood putty provided. Simply push the putty into each hole using your thumb and wipe excess putty off the surface using a damp cloth.

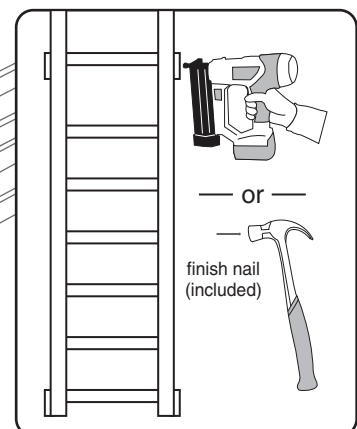
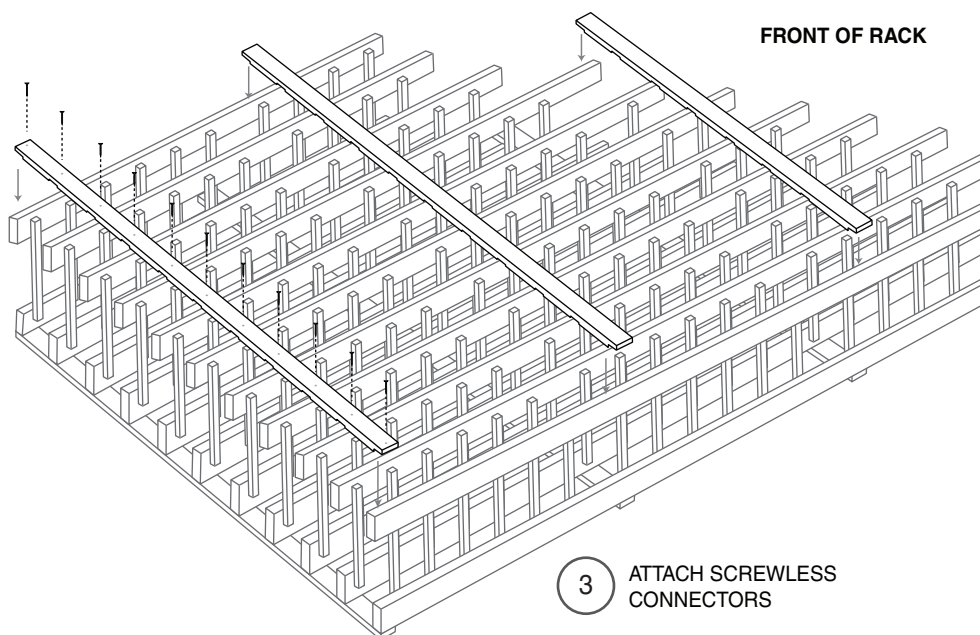

3 ATTACH SCREWLESS CONNECTORS

4 SECURE WITH FINISH NAILS



# WATERFALL WINE CELLAR KIT

## ASSEMBLY GUIDE

Page 4

Questions?  
**888.373.6057**  
or visit  
**wineracksamerica.com**

7. Begin securing the 1-column connectors. The rack should still be flat on the floor and not standing upright.

**\*If you are assembling the Single Deep Waterfall Rack follow step 8 for the back of the rack and step 9 for the front.**

**\*If you are assembling the Double Deep Waterfall Rack please skip step 8 and follow step 9 for the front & back of the rack.**

8. Attach nine 1-column standard connectors to columns 1,2,3,4,5,6,8,9 & 10 using the screws provided. Make sure that the top of the connector is flush with the top of the shorter vertical ladder assembly. The connector on column 1 should be flush with the top of the rack. (figure 5)

9. Attach one standard 1-column connector to column 1 using the screws provided. Make sure the top of the connector is flush with the top of the rack.

Attach (8) scalloped 1-column connectors to columns 2,3,4,5,6,8,9 & 10 following the same process you used to attach the screwless connectors in steps 5 & 6. (figure 6)

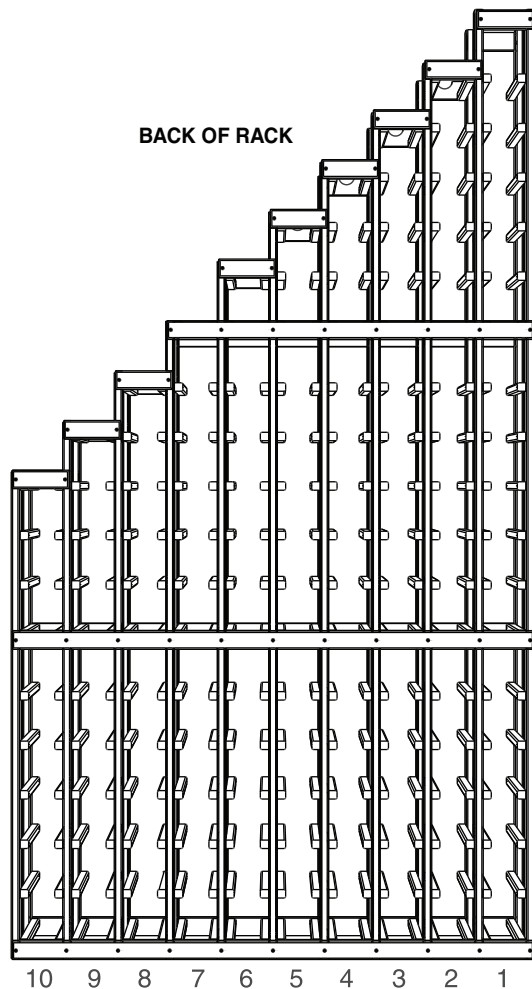

BACK OF RACK

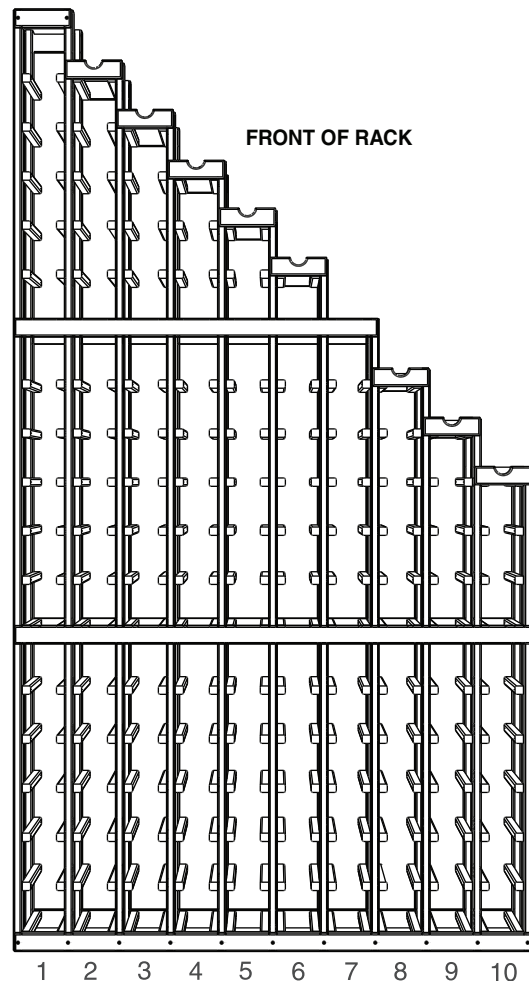

FRONT OF RACK

5 ATTACH THE 1-COLUMN CONNECTORS

6 ATTACH THE 1-COLUMN SCALLOPED CONNECTORS



# WATERFALL WINE CELLAR KIT

## ASSEMBLY GUIDE

Page 5

Questions?  
**888.373.6057**

or visit  
**wineracksamerica.com**

10. Attach the (3) Horizontal Trim Pieces to the sides of the 1st, 7th and 10th column of the rack. (figure 7)

The Trim Pieces should fit snugly between the two vertical risers pieces on each vertical ladder, simply attach the Trim Piece by putting a small finish nail or staple through each end of the Trim Piece securing it to both vertical risers. (figure 8)

\*If you have the Double Deep Waterfall rack you will need to use 3 finish nails or staples for each Trim Piece as the vertical ladders on the Double Deep Waterfall Rack have three vertical risers instead of two. (figure 9)

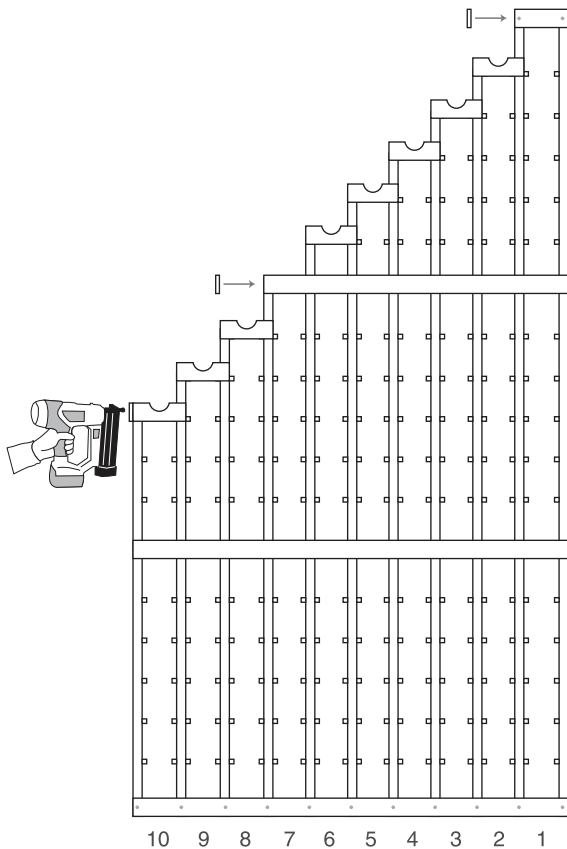

7 ATTACH THE TRIM PIECES

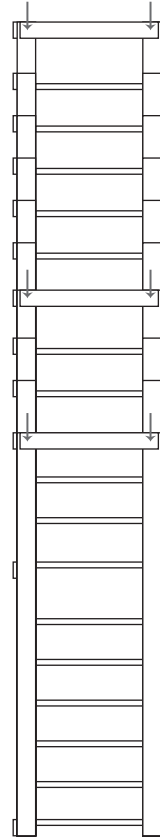

8 SECURE TRIM PIECES USING FINISH NAILS

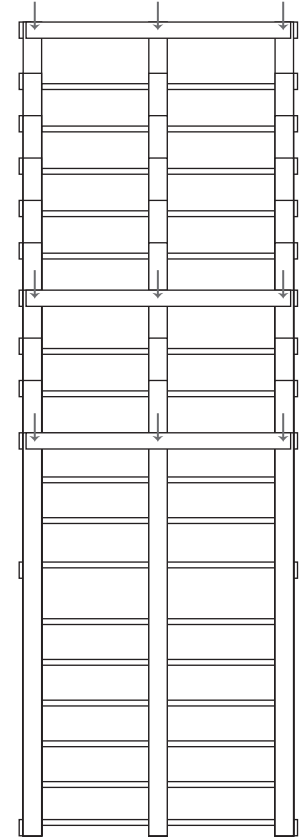

9

11. That's it! Enjoy this beautiful rack with your favorite beverage. Pair with other rack styles for an ultimate cellar storage look.



**WINERACKSAMERICA.COM**

We would love to see your wine racks in use! Please feel free to send any photos of your racks to [photos@wineracksamerica.com](mailto:photos@wineracksamerica.com)

Once again, thank you for your business. Remember, customer service is available to answer any questions Monday-Friday 7:00 am - 5:00 pm MST. Please feel free to contact us for any wine storage needs.

360 North 700 West Suite F • North Salt Lake, UT 84054  
(toll free) 888-373-6057  
(fax) 801-936-0534