



STANDARD TASTING TABLE ASSEMBLY GUIDE

Page 1

Questions?
888.373.6057

or visit
wineracksamerica.com

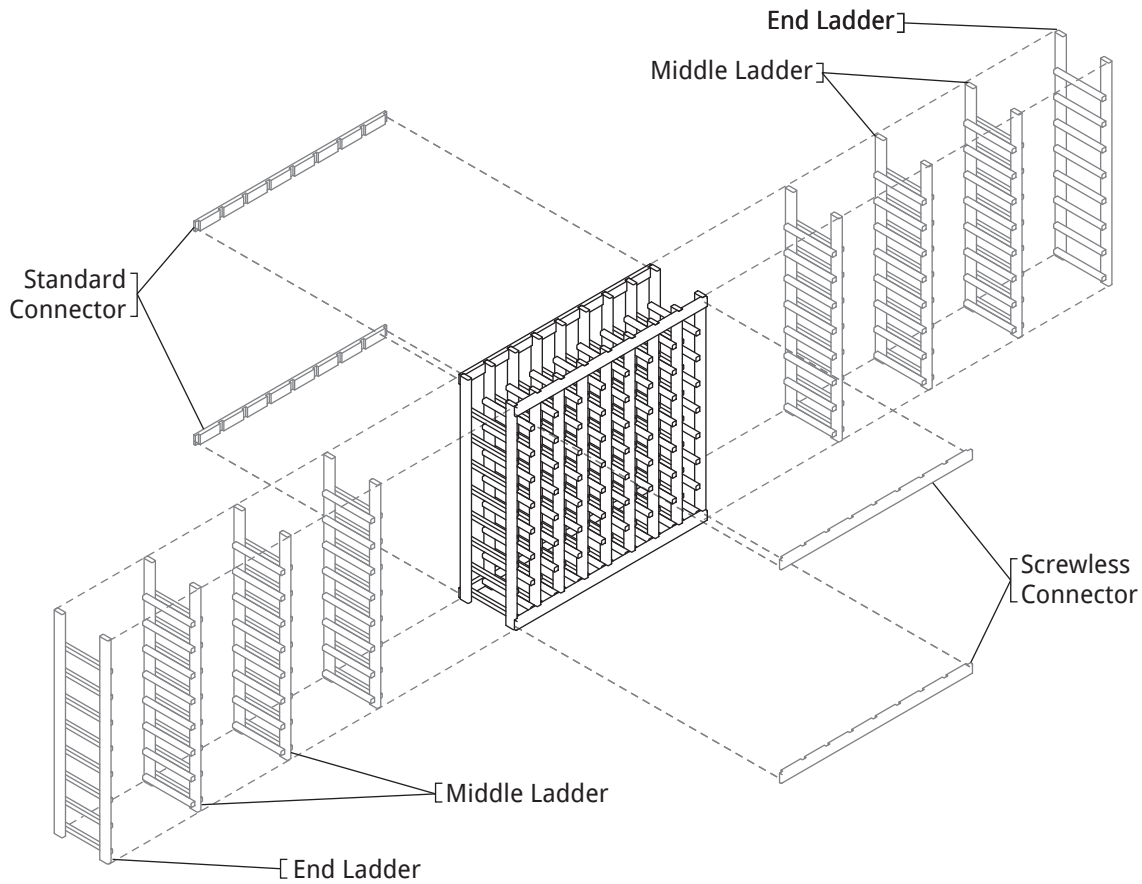

PACKAGE CONTENTS

*Please verify that you have the correct number of parts before proceeding.
Depending on the model you purchased, your bundle should contain the following:

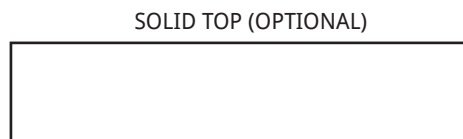
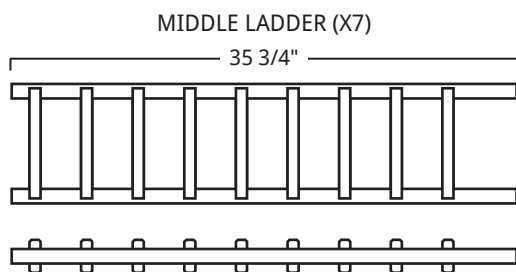
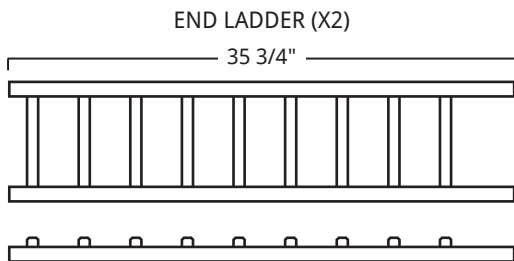

TOOLS FOR ASSEMBLY

Required



Suggested

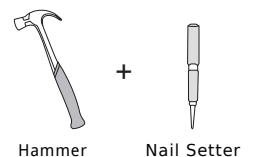



STANDARD TASTING TABLE ASSEMBLY GUIDE

Questions?
888.373.6057

or visit
wineracksamerica.com

Page 2

1. Find an open, flat area in which to work. Carefully remove all components from the box and remove banding with a utility knife. Check the parts list to verify package contents.
2. Arrange the end ladders on the floor so that the bottle support pieces face one another. Align the large gaps on each end ladder. The end with the larger gap is the top of your rack. Attach a standard 8 column connector to the top and bottom of your rack using the screws provided. Make sure the connectors are flush with the top and bottom of your rack. (figure 1)

* Minimize the risk of splitting your ladders by drilling a 1/16" pilot hole before driving the wood screws. For best results, drive the screw most of the way in with your drill, then finish tightening by hand.

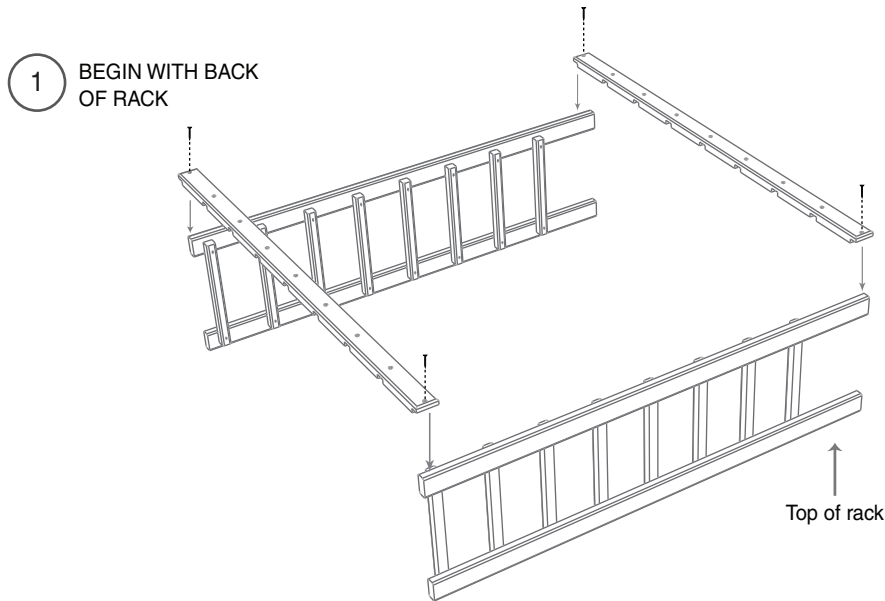

-
3. Insert the middle ladders and finish securing the top & bottom connectors using the screws provided. (figure 2)

2 FINISH SECURING BACK CONNECTORS

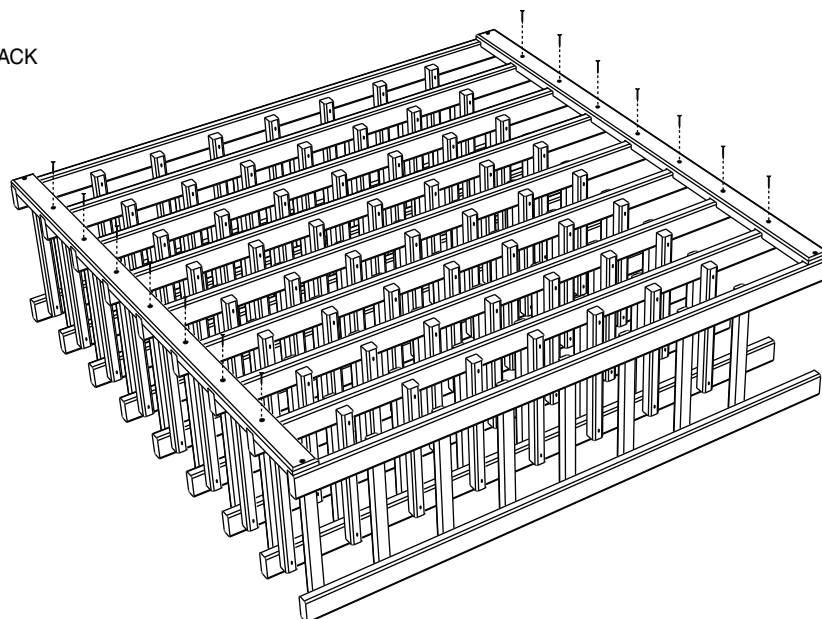

4. Flip rack over. Attach a screwless 8 column connector to the top and bottom of your rack. Make sure the rack is flat on the floor while attaching screwless connectors. (figure 3)

Standard Tasting Table kits are designed to show no visible hardware on the front of the rack. Use of of these following methods to install the screwless connectors:

- A** For no visible hardware, add wood glue to the inside of each connector notch. Place the connector on your rack and carefully press each notch into place. Hold until glue is dry. (figure A)
- B** For minimal visible hardware, add wood glue to the inside of each connector notch. Place the connector on your rack and carefully press each notch into place. Hold until glue is dry. For added support, use a finish nailer to attach the connector to the two end ladders and one middle ladder. (figure B)
- C** For a professional installation, secure the connectors using a finish nail gun to drive a nail through the connector into each vertical ladder. If you do not have a finish nail gun, drive one of the provided finish nails into each vertical ladder until it is flush. Then, countersink the nail using a nail setter until the head of the nail is about 1/16" below the surface of the wood. (figure C)

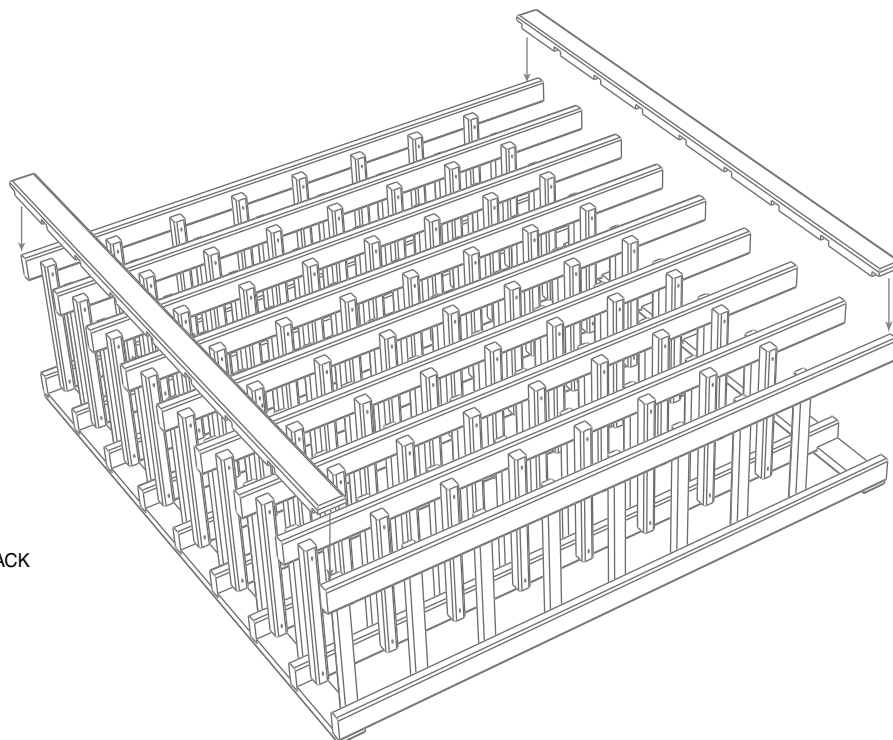
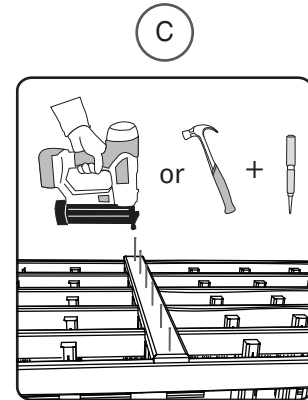
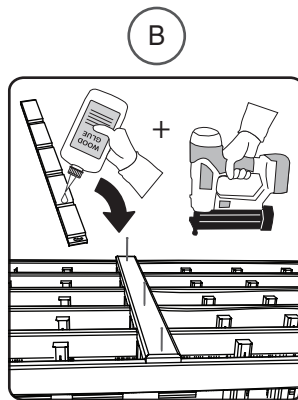
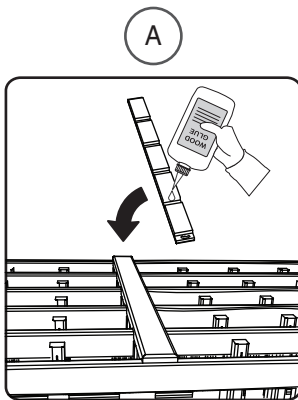

3 FRONT OF RACK



STANDARD TASTING TABLE ASSEMBLY GUIDE

Questions?
888.373.6057

or visit
wineracksamerica.com

Page 4

- If you purchased a Solid Top with your rack, secure it by adding wood glue to the tops of each vertical riser. Clamp the top to the frame using standard wood clamps until fully dry. (figure 4)

For extra support, use a nail gun to tack a nail through the top of the risers into the solid top support pieces. (figure 5)

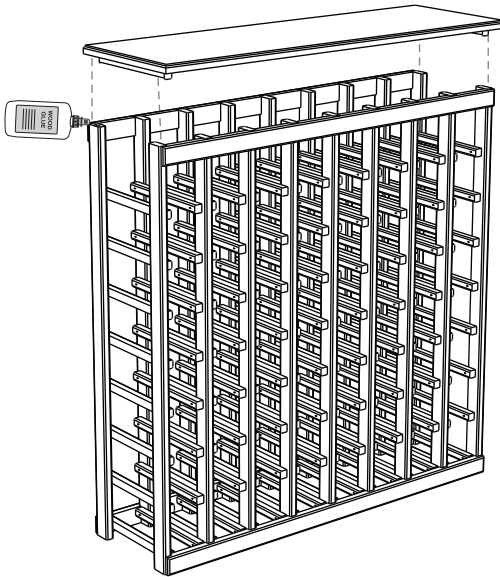

4 ATTACH SOLID TOP

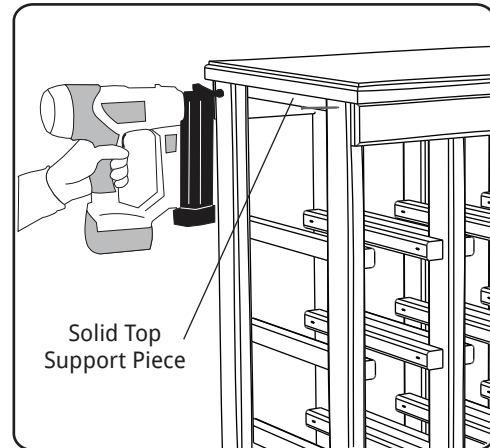

5 SECURE WITH FINISH NAILS

- Attaching your rack to the wall (optional). Depending on how many bottles you store, your wine cellar rack could weigh as much as 540 lbs. To avoid tipping, attach your rack to the wall using one of the following methods.

- Put the rack in the desired location.
- Shim the front of the rack so it is parallel with the wall behind it.
- Locate a wall stud behind the rack.
- Drive a 2 1/2" wood screw through a back spacer bar to attach to the stud.

- Use "L" brackets (located at any hardware store).
- Attach to both the rack and the wall in any out of the way spot.

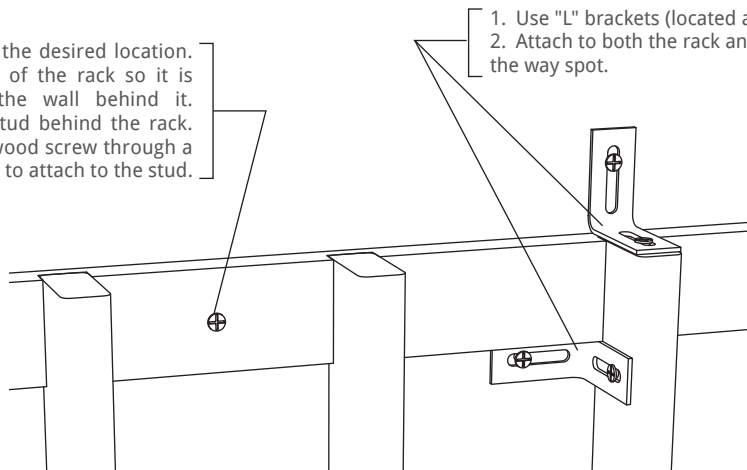

WINERACKSAMERICA.COM

We would love to see your wine racks in use! Please feel free to send any photos of your racks to photos@wineracksamerica.com

Once again, thank you for your business. Remember, customer service is available to answer any questions Monday-Friday 7:00 am - 5:00 pm MST. Please feel free to contact us for any wine storage needs.

360 North 700 West Suite F • North Salt Lake, UT 84054
(toll free) 888-373-6057
(fax) 801-936-0534