



MAGNUM/CHAMPAGNE KIT

ASSEMBLY GUIDE

Page 1

Questions?
888.373.6057

or visit
wineracksamerica.com

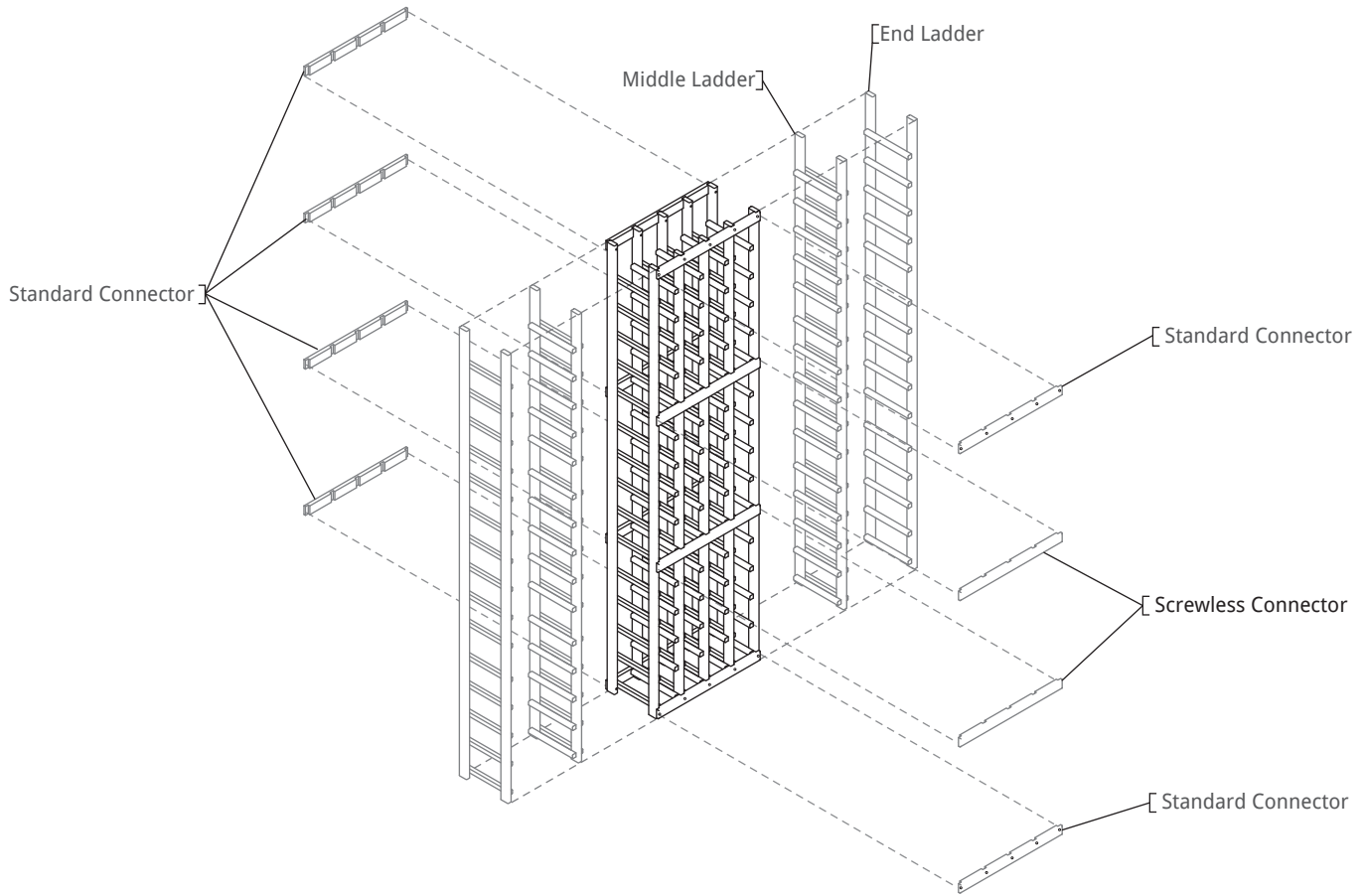

PACKAGE CONTENTS

TOOLS FOR ASSEMBLY

*All models follow the same assembly procedure varying only in the number of middle ladders your rack will require. Depending on the model you purchased, your bundle should contain the following:

END LADDER ASSEMBLIES

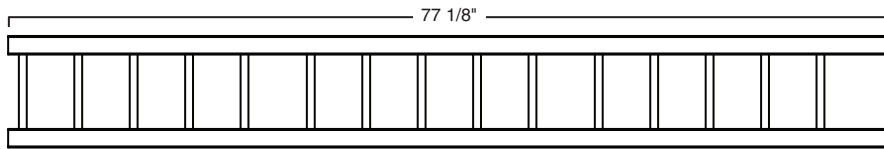

MIDDLE LADDER ASSEMBLIES

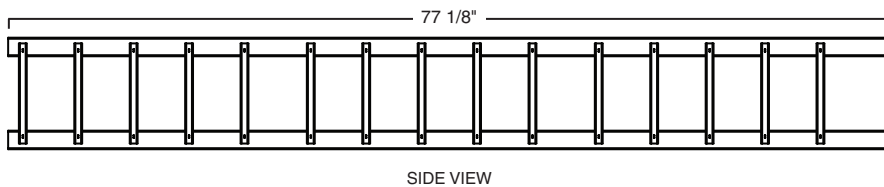

STANDARD CONNECTORS (Various Lengths)

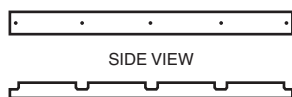

SCREWLESS CONNECTORS (Various Lengths)

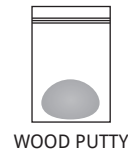

Required

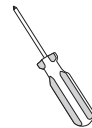

Screwdriver

Wood Glue

Suggested



Cordless Drill

Finish Nailer



+



Hammer

Nail Setter



MAGNUM/CHAMPAGNE KIT

ASSEMBLY GUIDE

Page 2

Questions?
888.373.6057

or visit
wineracksamerica.com

1. Find an open, flat area in which to work. Carefully remove all components from the box and remove banding with a utility knife. Check the parts list to verify package contents.
2. Arrange the end ladders on the floor so that the bottle support pieces face one another. Align the large gaps on each end ladder. The end with the larger gap is the top of your rack. Attach a standard column connector to the top and bottom of your rack using the screws provided. Make sure the connectors are flush with the top and bottom of your rack. (figure 1)

* Minimize the risk of splitting your ladders by drilling a 1/16" pilot hole before driving the wood screws. For best results, drive the screw most of the way in with your drill, then finish tightening by hand.

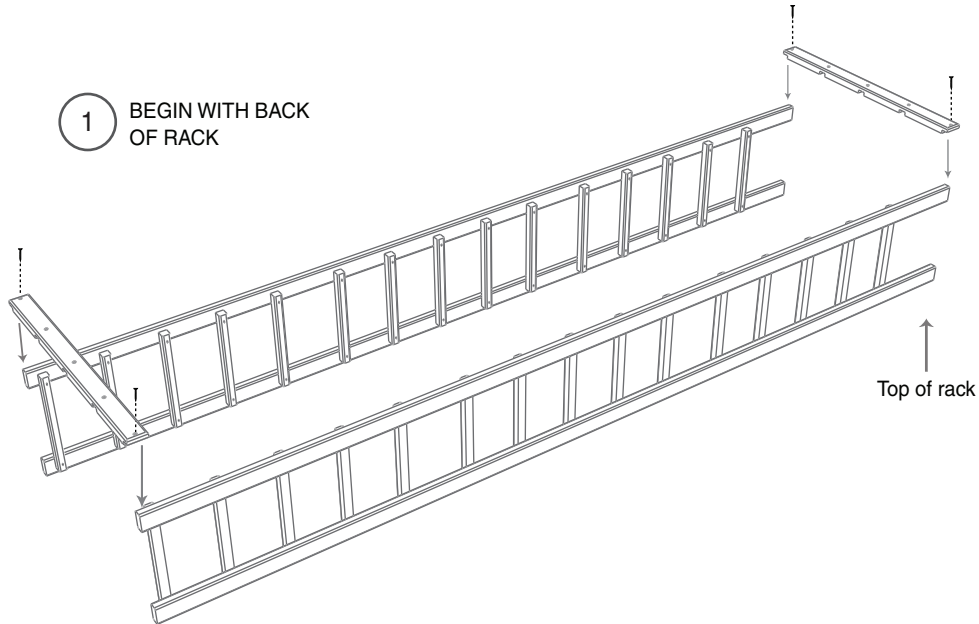

3. Insert the middle ladders and finish securing the top & bottom connectors using the screws provided.
4. Attach the middle standard connectors so that the top edge of the lower connector is 26 5/8" from the bottom of the rack, and the top edge of the upper connector is 51 3/4" from the bottom of the rack. Secure the middle connectors using the screws provided. This is the back of your rack. (figure 2)

2 FINISH SECURING BACK CONNECTORS

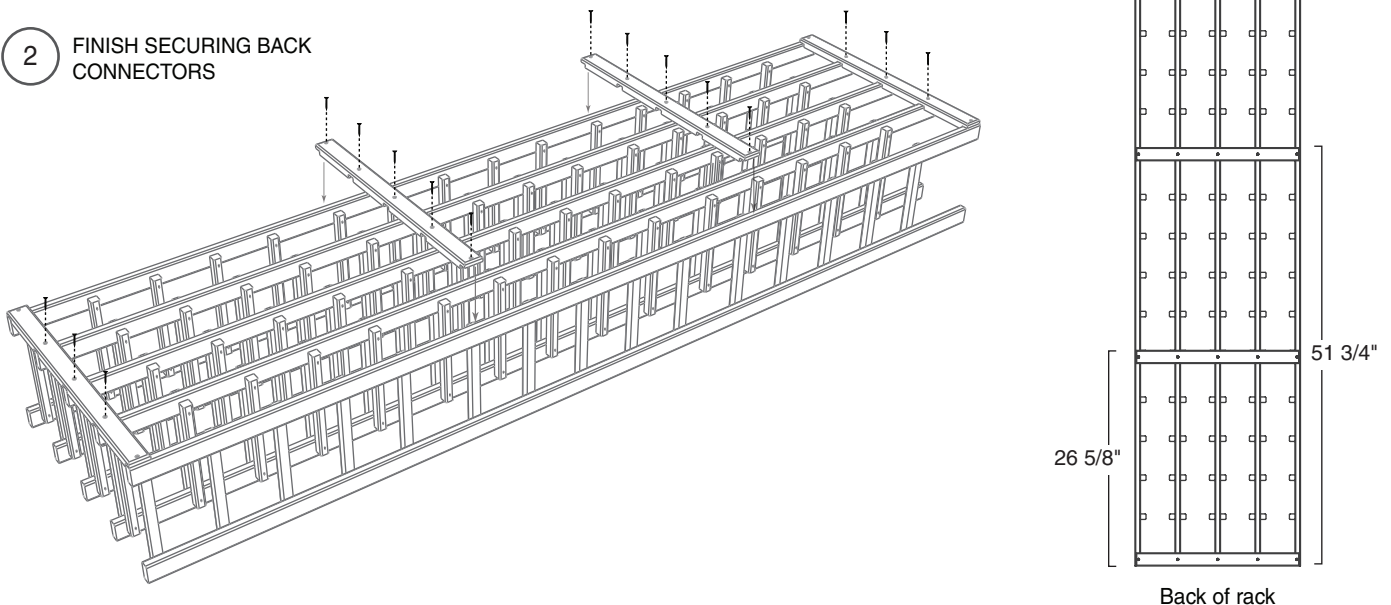

5. Flip rack over and secure a standard column connector to the top and bottom of your rack using the screws provided. (figure 3)

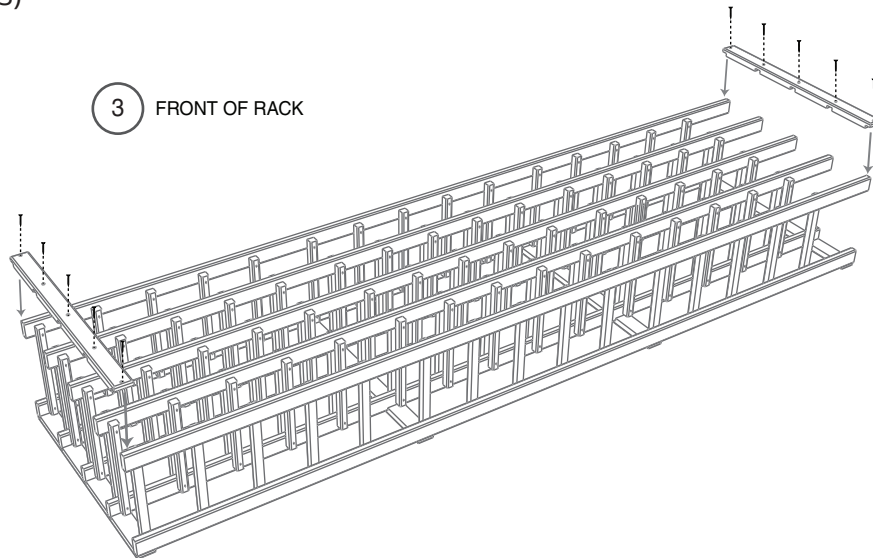

6. Attach the middle screwless connectors so that the top edge of the lower connector is 26 5/8" from the bottom of the rack, and the top edge of the upper connector is 51 3/4" from the bottom of the rack. Make sure the rack is flat on the floor while attaching the screwless connectors. (figure 4)

Magnum/Champagne kits are designed to show no visible hardware on the front of the rack. Use one of the following methods to install the screwless connectors:

- A** For no visible hardware, add wood glue to the inside of each connector notch. Place the connector on your rack and carefully press each notch into place. Hold until glue is dry. (figure A)
- B** For minimal visible hardware, add wood glue to the inside of each connector notch. Place the connector on your rack and carefully press each notch into place. Hold until glue is dry. For added support, use a finish nailer to attach the connector to the two end ladders and one middle ladder. (figure B)
- C** For a professional installation, secure the connectors using a finish nail gun to drive a nail through the connector into each vertical ladder. If you do not have a finish nail gun, drive one of the provided finish nails into each vertical ladder until it is flush. Then, countersink the nail using a nail setter until the head of the nail is about 1/16" below the surface of the wood. (figure C)
- D** (Optional) Purchase Crown and Base molding to cover the hardware of the top and bottom standard connectors on the front of the rack. (figure D)

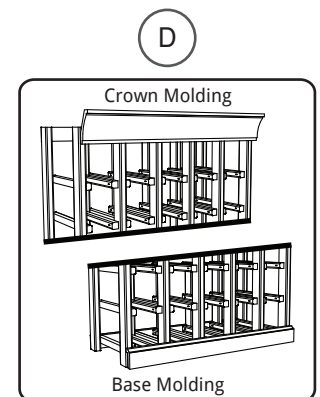
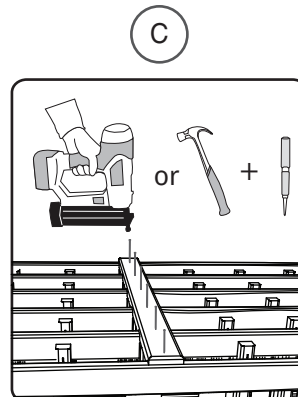
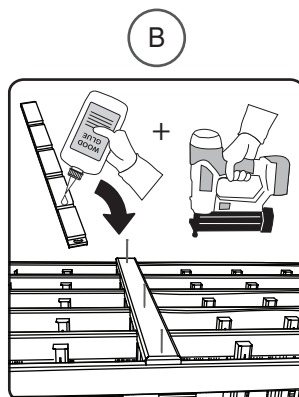
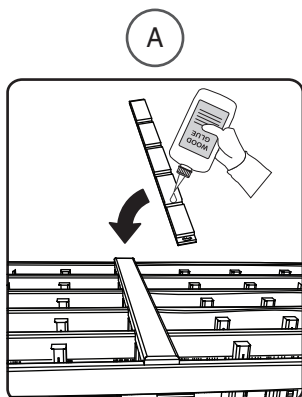



MAGNUM/CHAMPAGNE KIT

ASSEMBLY GUIDE

Page 4

Questions?
888.373.6057

or visit
wineracksamerica.com

4 ATTACH SCREWLESS CONNECTORS

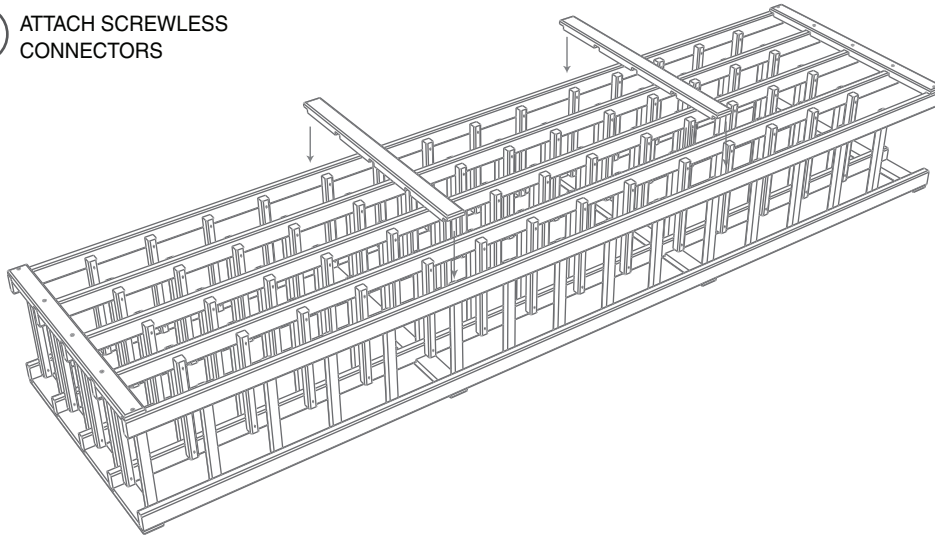

7. Fill the nail holes using the wood putty provided. Simply push the putty into each hole using your thumb and wipe excess putty off the surface using a damp cloth.

8. Attaching your rack to the wall (optional). Depending on how many bottles you store, your wine cellar rack could weigh as much as 540 lbs. To avoid tipping, attach your rack to the wall using one of the following methods.

1. Put the rack in the desired location.
2. Shim the front of the rack so it is parallel with the wall behind it.
3. Locate a wall stud behind the rack.
4. Drive a 2 1/2" wood screw through a back spacer bar to attach to the stud.

1. Use "L" brackets (located at any hardware store).
2. Attach to both the rack and the wall in any out of the way spot.

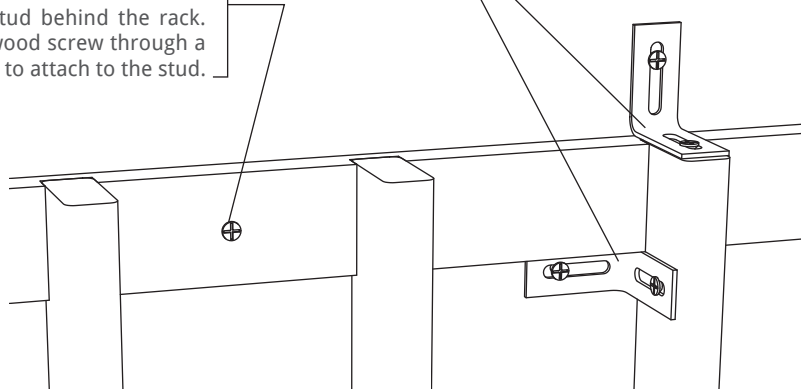

WINERACKSAMERICA.COM

We would love to see your wine racks in use! Please feel free to send any photos of your racks to photos@wineracksamerica.com

Once again, thank you for your business. Remember, customer service is available to answer any questions Monday-Friday 7:00 am - 5:00 pm MST. Please feel free to contact us for any wine storage needs.

360 North 700 West Suite F • North Salt Lake, UT 84054
(toll free) 888-373-6057
(fax) 801-936-0534