



SCALLOPED WINE RACK

ASSEMBLY GUIDE

Page 1

Questions?
888.373.6057

or visit
wineracksamerica.com

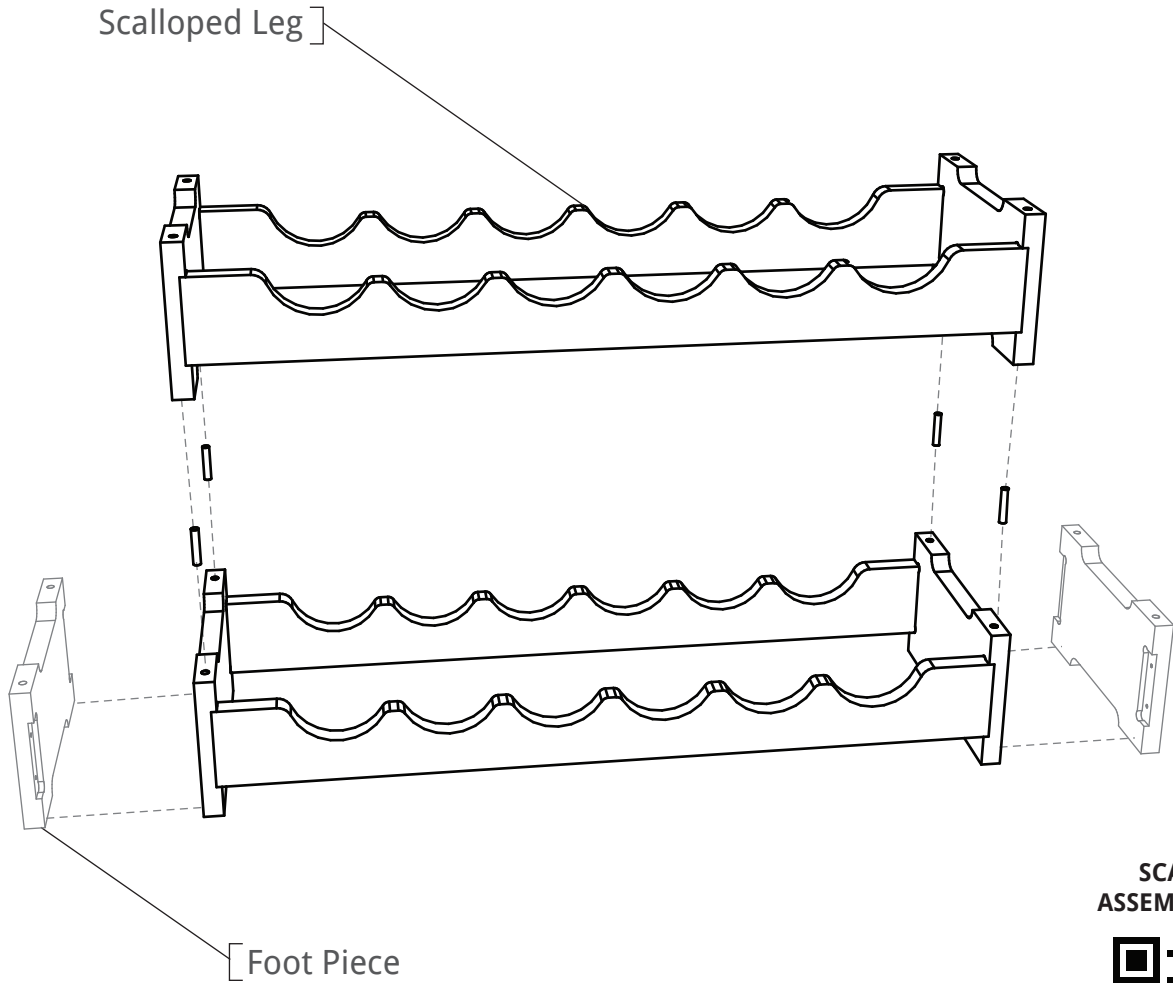

SCAN FOR
ASSEMBLY VIDEO



PACKAGE CONTENTS

TOOLS FOR ASSEMBLY

*Please verify that you have the correct number of parts before proceeding.
Depending on the model you purchased, your bundle should contain the following:

RACK	SCALLOPED LEG	FOOT PIECE	WOOD SCREWS	WOOD DOWELS
1 row	2	2	8	4
2 rows	4	4	16	4
3 rows	6	6	24	8
4 rows	8	8	32	12

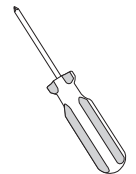

Screwdriver

or

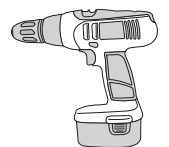

Cordless Drill

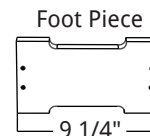
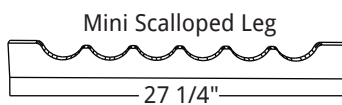
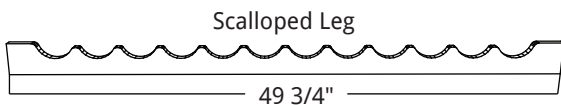



SCALLOPED WINE RACK ASSEMBLY GUIDE

Page 2

Questions?
888.373.6057
or visit
wineracksamerica.com

1. Find an open, flat area in which to work. Carefully remove all components from the box and remove banding with a utility knife. Check the parts list to verify package contents.
2. Insert a scalloped leg into one of the notched slots on the foot piece. Use provided screws to attach each scalloped leg to a foot piece using the pre-drilled holes. Make sure the front of the scalloped leg is flush with the end of the foot piece.

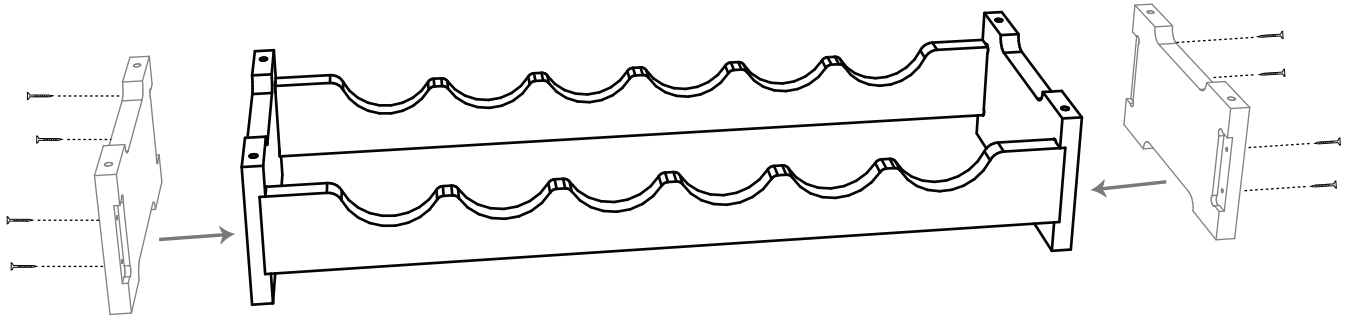

3. If you purchased more than one scalloped rack, attach each rack using the provided wood dowels. Simply push the dowels into each notch on the top of your rack. Then, line up the holes on the upper rack and carefully press into place. Repeat this step for all remaining scalloped shelves.

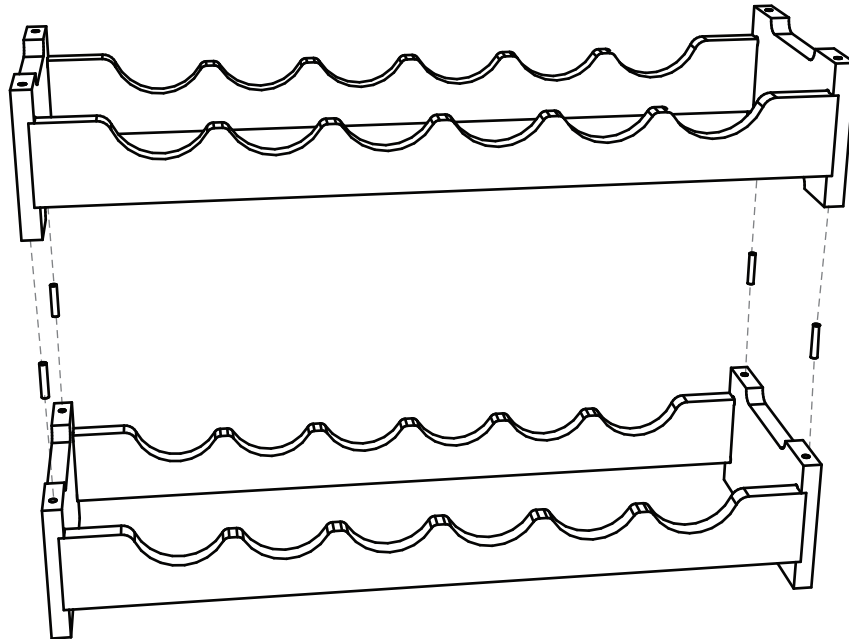

WINERACKSAMERICA.COM

Once again, thank you for your business. Remember, customer service is available to answer any questions Monday-Friday 7:00 am - 5:00 pm MST. Please feel free to contact us for any wine storage needs.

360 North 700 West Suite F • North Salt Lake, UT 84054
(toll free) 888-373-6057
(fax) 801-936-0534