

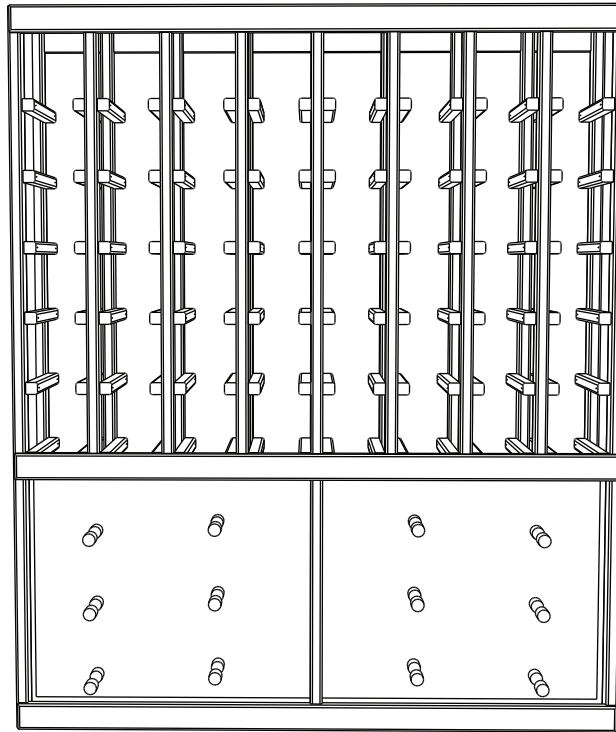

35" SHOWCASE DISPLAY ASSEMBLY GUIDE

Page 1

Questions?
888.373.6057
or visit
wineracksamerica.com



PACKAGE CONTENTS

*Please verify that you have the correct number of parts before proceeding.
Depending on the model you purchased, your bundle should contain the following:

END LADDER
(X2)

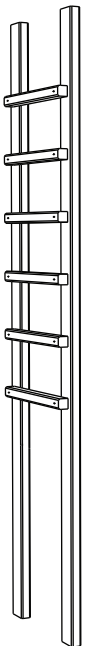

CENTER LADDER
(X1)

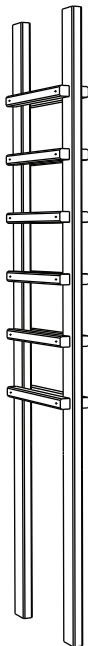

MIDDLE LADDER
(X6)

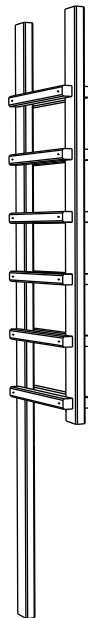

STANDARD CONNECTOR (X2)



SCREWLESS CONNECTOR (X2)



REVEAL CONNECTOR (X1)



PIN PANEL

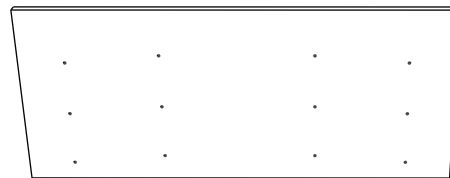

NECK PINS



BASE PINS

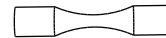

WOOD PUTTY



FINISH NAILS



PIN SCREWS



WOOD SCREWS

TOOLS FOR ASSEMBLY

Required

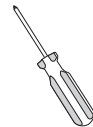

Screwdriver



Wood Glue

Suggested

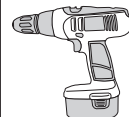

Cordless Drill



Finish Nailer



Hammer

+



Nail Setter



35" SHOWCASE DISPLAY ASSEMBLY GUIDE

Questions?
888.373.6057

or visit
wineracksamerica.com

Page 2

1. Find an open, flat area in which to work. Carefully remove all components from the box and remove banding with a utility knife. Check the parts list to verify package contents.
2. Arrange the end ladders on the floor so that the bottle support pieces face one another. Align the large gaps on each end ladder. The end with the larger gap is the bottom of your rack. Attach a standard connector to the top and bottom of your rack using the screws provided. Make sure the connectors are flush with the top and bottom of your rack. (figure 1)

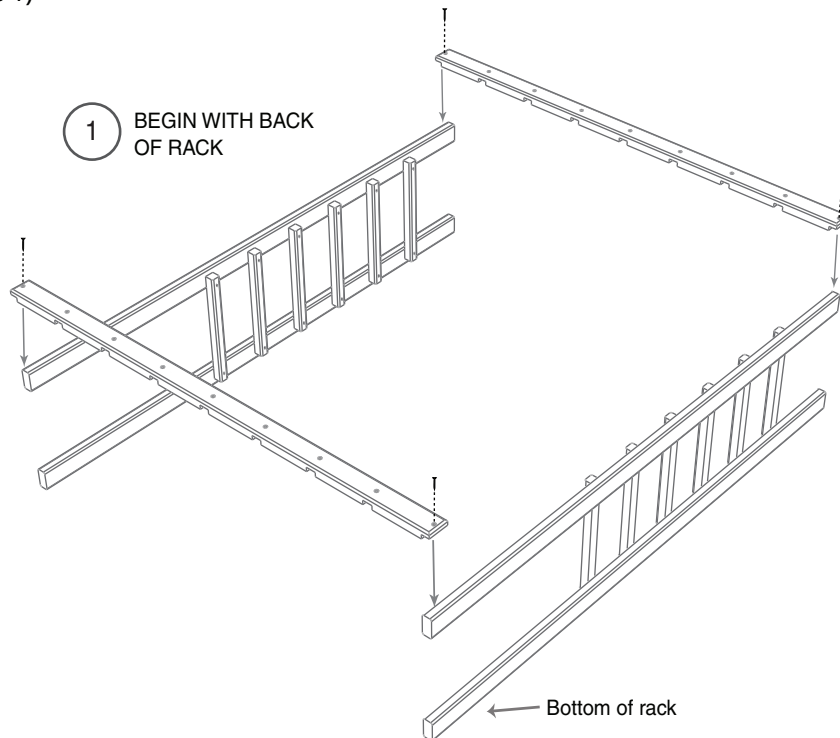

-
3. Insert the middle ladders and finish securing the top & bottom connectors using the screws provided. Make sure that the Center Ladder is attached in the middle of the rack. (figure 2)

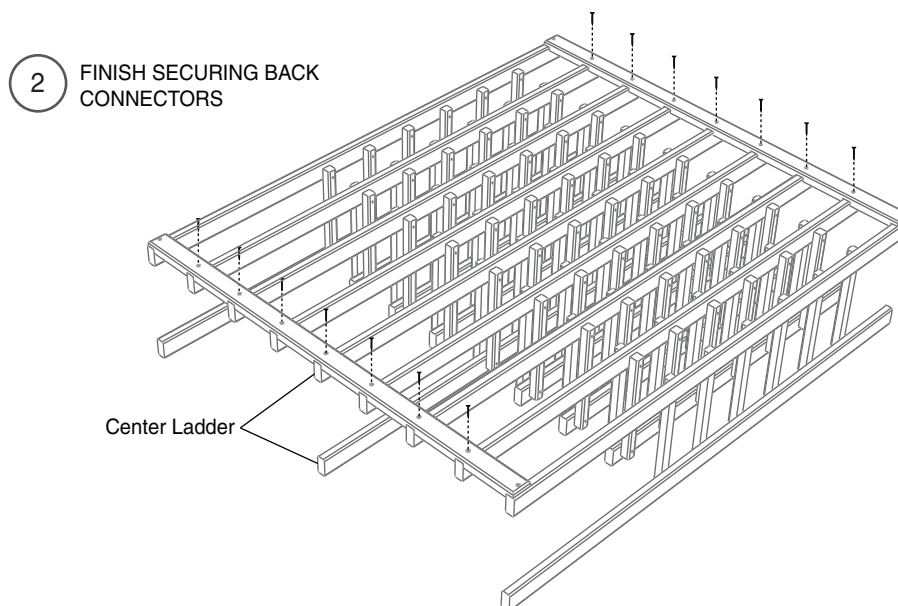



35" SHOWCASE DISPLAY ASSEMBLY GUIDE

Questions?
888.373.6057

or visit
wineracksamerica.com

Page 3

4. Flip the rack over and attach a screwless connector to the top of the rack (figure 3). Attach the remaining screwless connector so that the bottom of the connector aligns with the bottom of the middle ladder risers (figure 4). Secure the bottom reveal connector to the two end ladders and center ladder at the bottom of the rack. (figure 5).

High Reveal Racks are designed to show no visible hardware on the front of the rack. Use one of these following methods to install the screwless connectors:

- (A) For no visible hardware, add wood glue to the inside of each connector notch. Place the connector on your rack and carefully press each notch into place. Hold until glue is dry. (figure A)
- (B) For minimal visible hardware, add wood glue to the inside of each connector notch. Place the connector on your rack and carefully press each notch into place. Hold until glue is dry. For added support, use a finish nailer to attach the connector to the two end ladders and one middle ladder. (figure B)
- (C) For a professional installation, secure the connectors using a finish nail gun to drive a nail through the connector into each vertical ladder. If you do not have a finish nail gun, drive one of the provided finish nails into each vertical ladder until it is flush. Then, countersink the nail using a nail setter until the head of the nail is about 1/16" below the surface of the wood. Use provided wood putty to fill nail holes. (figure C)

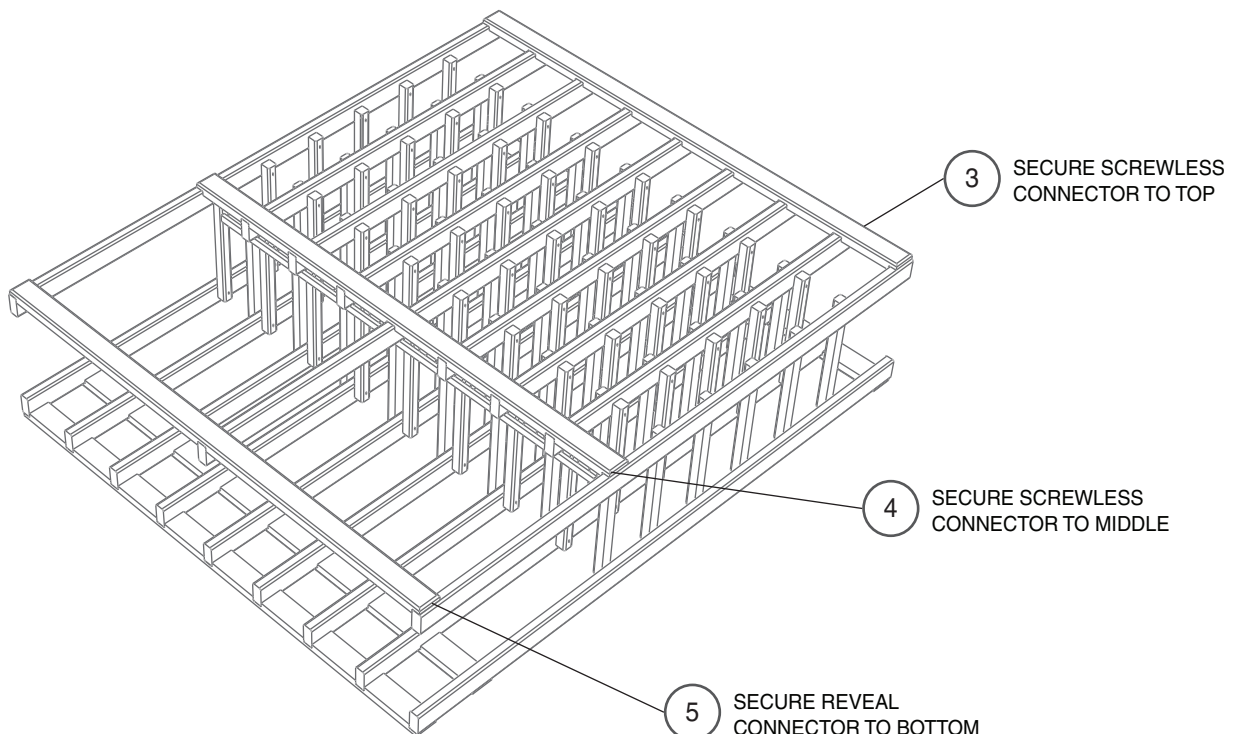
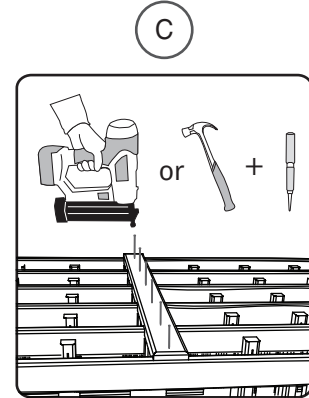
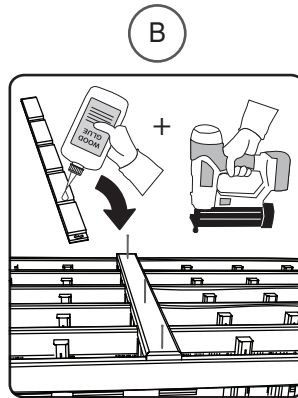
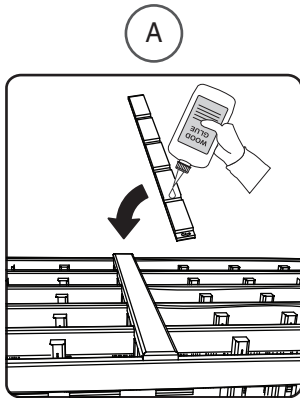

5. To attach the metal pins to the panels, slide the pin screws through the pre-drilled holes on the back of the panel. Using a screwdriver, tighten each pin screw into each metal pin. (figure 6)

Orient each metal base and neck pin as shown in figure 7. The end with the larger gap is the top of the panel.

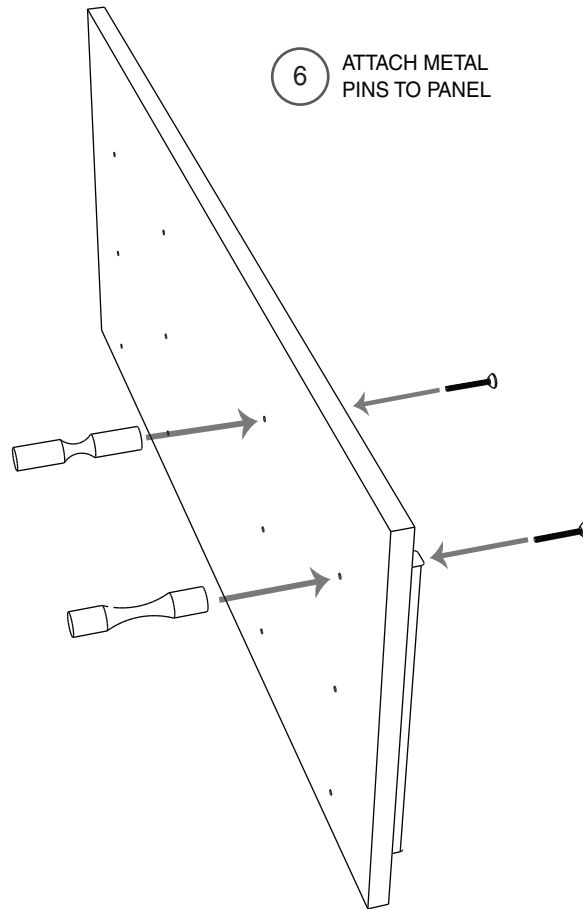

7 ORIENT BASE & NECK PINS

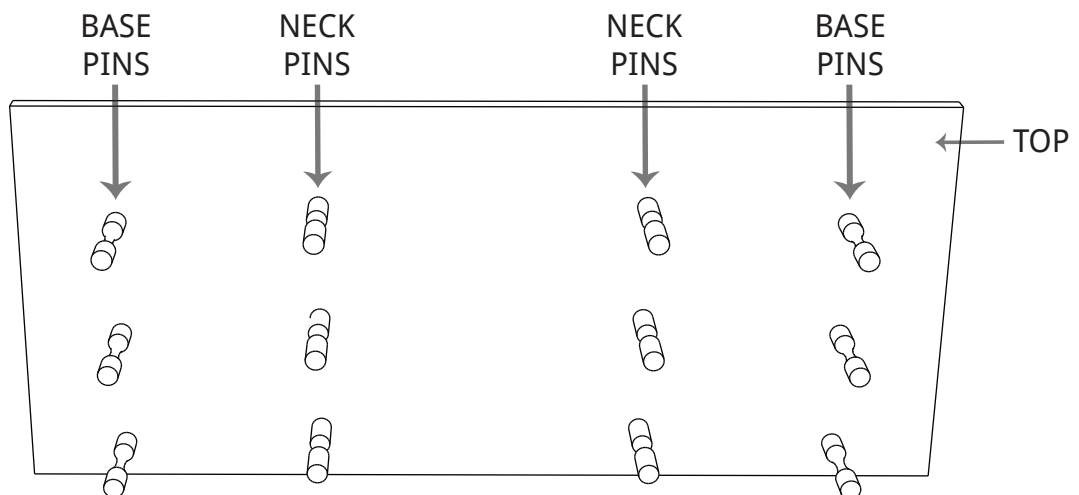



35" SHOWCASE DISPLAY ASSEMBLY GUIDE

Page 5

Questions?
888.373.6057

or visit
wineracksamerica.com

- Stand the rack up and set the pin panel so that the support bars fit snug between the two end risers on the back of the rack. (figure 8)
- To attach the pin panel to the rack, use a screwdriver or drill to drive a wood screw through the pre-drilled holes on each support bar into the aligning riser. (figure 9)

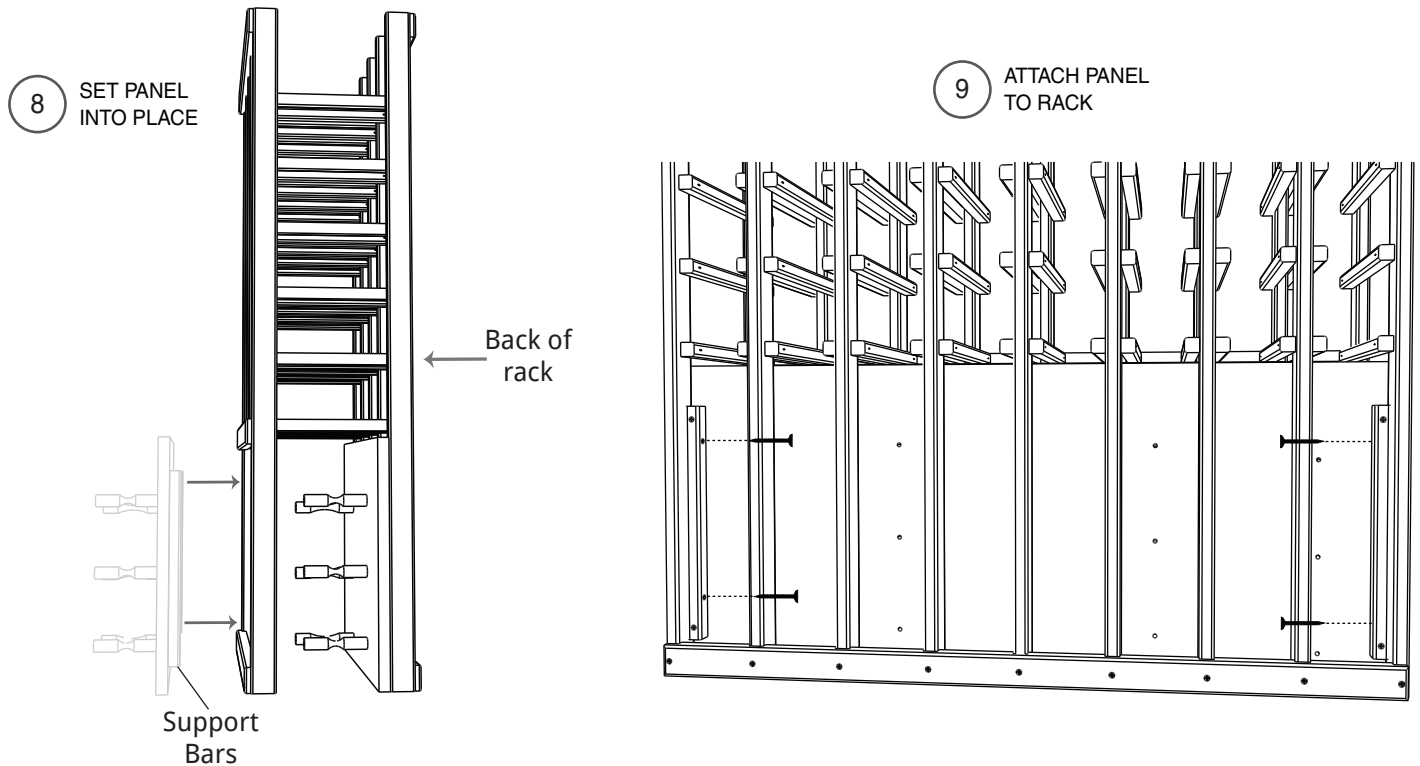

- The assembly of your showcase display rack is now complete and you are ready to place the rack above any base rack of your choice.



WINERACKSAMERICA.COM

We would love to see your wine racks in use! Please feel free to send any photos of your racks to photos@wineracksamerica.com

Once again, thank you for your business. Remember, customer service is available to answer any questions Monday-Friday 7:00 am - 5:00 pm MST. Please feel free to contact us for any wine storage needs.

360 North 700 West Suite F • North Salt Lake, UT 84054
(toll free) 888-373-6057
(fax) 801-936-0534