

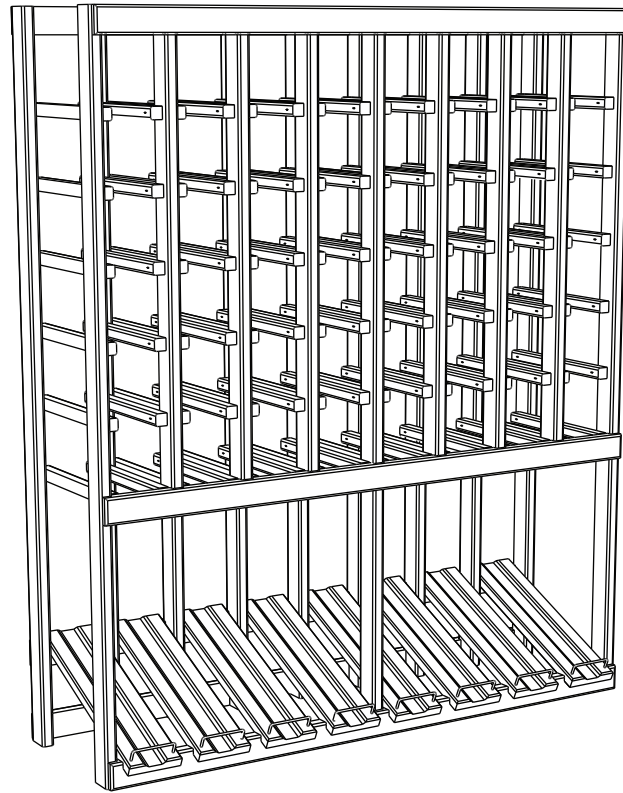

HIGH REVEAL RACK ASSEMBLY GUIDE

Questions?
888.373.6057
or visit
wineracksamerica.com



PACKAGE CONTENTS

TOOLS FOR ASSEMBLY

*All models follow the same assembly procedure varying only in the number of middle ladders your rack will require.

*Please verify that you have the correct number of parts before proceeding.
Depending on the model you purchased, your bundle should contain the following:

END LADDER
(X2)

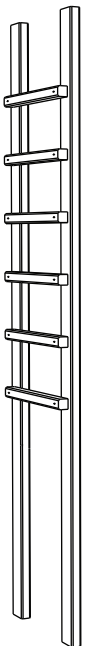

CENTER LADDER
(X1)

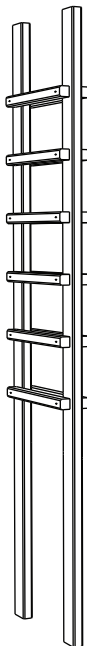

MIDDLE LADDER
(X6)

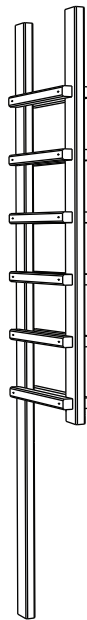

STANDARD CONNECTOR (X3)



SCREWLESS CONNECTOR (X2)



REVEAL CONNECTOR (X1)



DISPLAY TRAYS

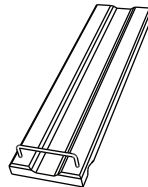

SIDE DISPLAY PIECE
(OPTIONAL X2)

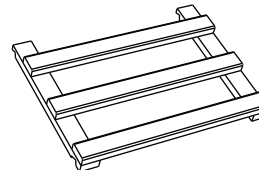

WOOD PUTTY



FINISH NAILS



WOOD SCREWS

Required

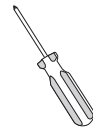

Screwdriver



Wood Glue

Suggested

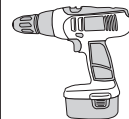

Cordless Drill



Finish Nailer



Hammer

+



Nail Setter



HIGH REVEAL RACK ASSEMBLY GUIDE

Questions?
888.373.6057

or visit
wineracksamerica.com

Page 2

1. Find an open, flat area in which to work. Carefully remove all components from the box and remove banding with a utility knife. Check the parts list to verify package contents.
2. Arrange the end ladders on the floor so that the bottle support pieces face one another. Align the large gaps on each end ladder. The end with the larger gap is the bottom of your rack. Attach a standard connector to the top and bottom of your rack using the screws provided. Make sure the connectors are flush with the top and bottom of your rack. (figure 1)

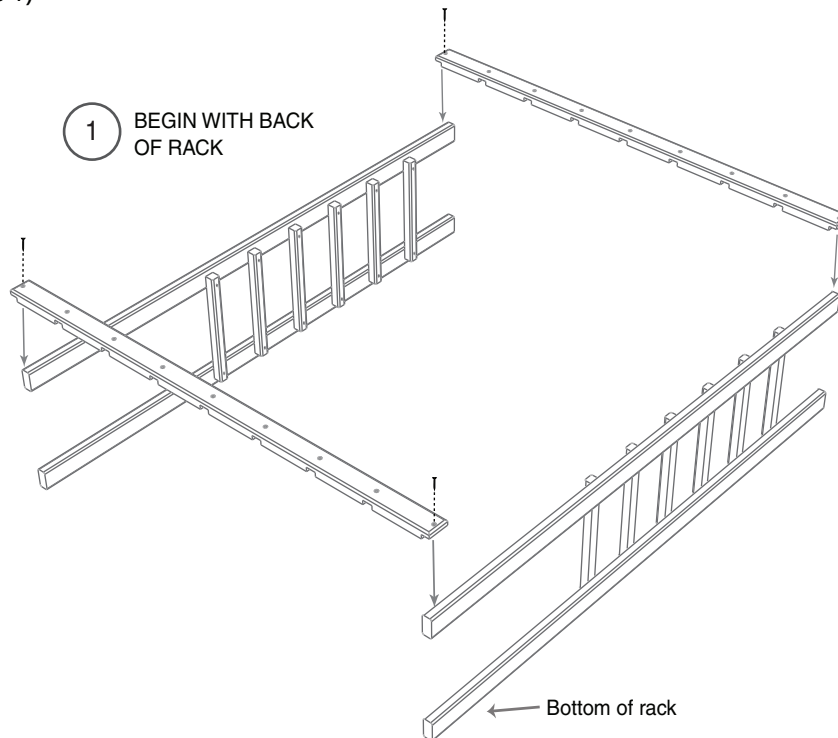

-
3. Insert the middle ladders and finish securing the top & bottom connectors using the screws provided. Make sure that the Center Ladder is attached in the middle of the rack. (figure 2)

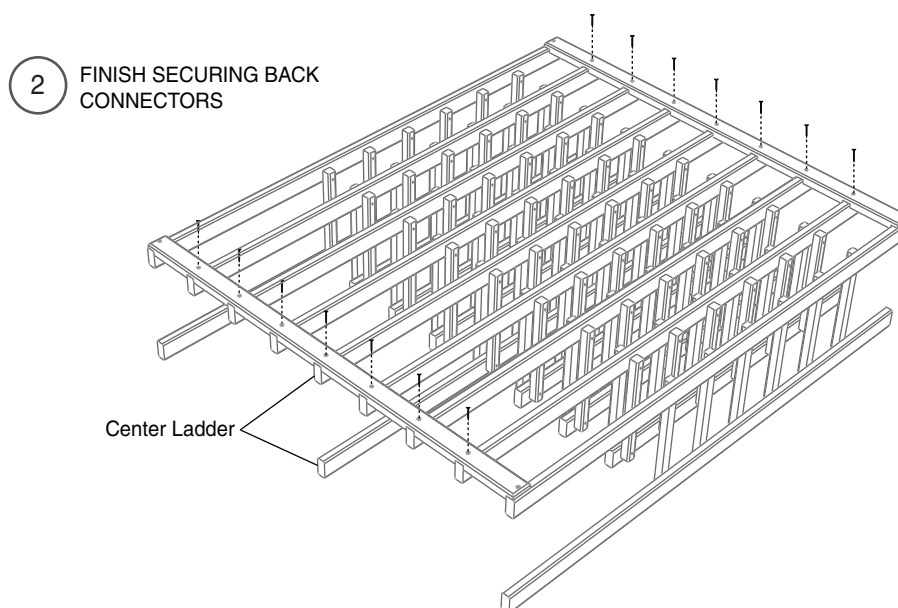

4. Secure the remaining standard connector so that the top of the connector is 6" from the bottom of the rack. (figure 3)

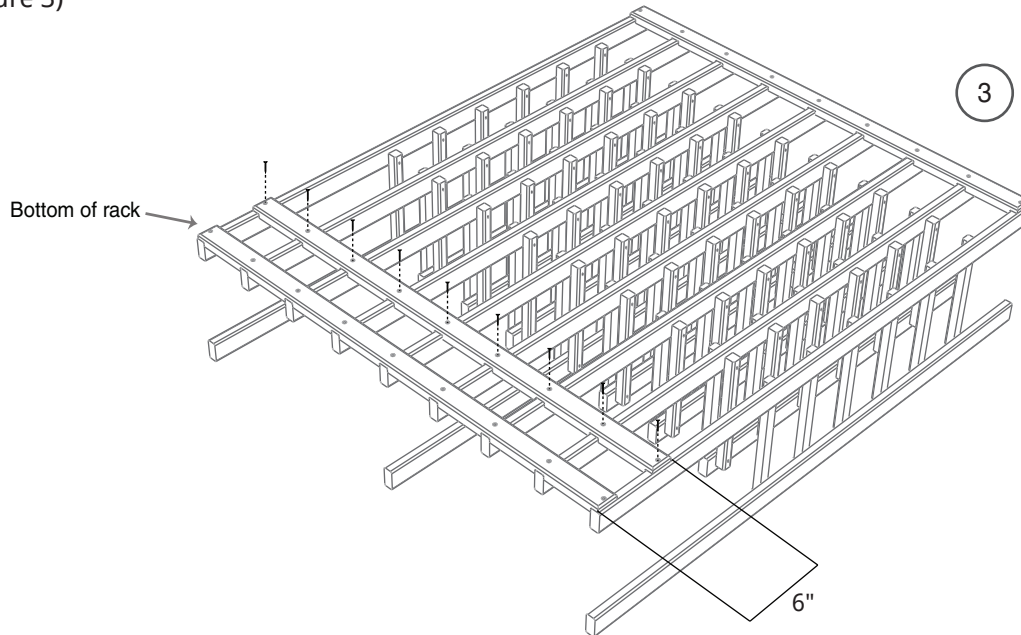

3 ATTACH REMAINING STANDARD CONNECTOR

5. Flip the rack over and attach a screwless connector to the top of the rack (figure 4). Attach the remaining screwless connector so that the bottom of the connector aligns with the bottom of the middle ladder risers (figure 5). Secure the bottom reveal connector to the two end ladders and center ladder at the bottom of the rack. (figure 6).

High Reveal Racks are designed to show no visible hardware on the front of the rack. Use one of these following methods to install the screwless connectors:

- A For no visible hardware, add wood glue to the inside of each connector notch. Place the connector on your rack and carefully press each notch into place. Hold until glue is dry. (figure A)
- B For minimal visible hardware, add wood glue to the inside of each connector notch. Place the connector on your rack and carefully press each notch into place. Hold until glue is dry. For added support, use a finish nailer to attach the connector to the two end ladders and one middle ladder. (figure B)
- C For a professional installation, secure the connectors using a finish nail gun to drive a nail through the connector into each vertical ladder. If you do not have a finish nail gun, drive one of the provided finish nails into each vertical ladder until it is flush. Then, countersink the nail using a nail setter until the head of the nail is about 1/16" below the surface of the wood. Use provided wood putty to fill nail holes. (figure C)

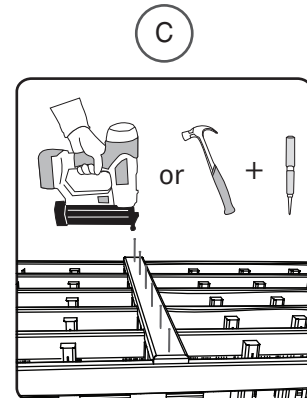
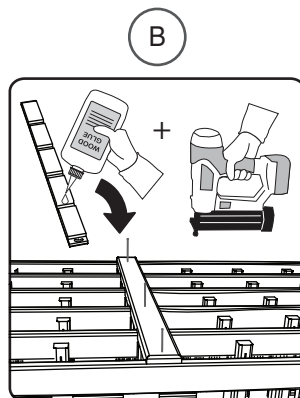
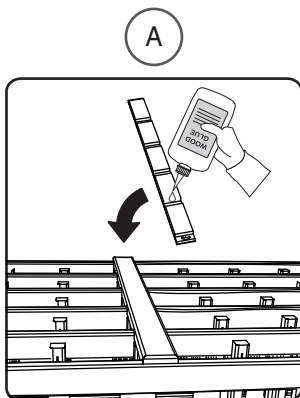



HIGH REVEAL RACK ASSEMBLY GUIDE

Page 4

Questions?
888.373.6057

or visit
wineracksamerica.com

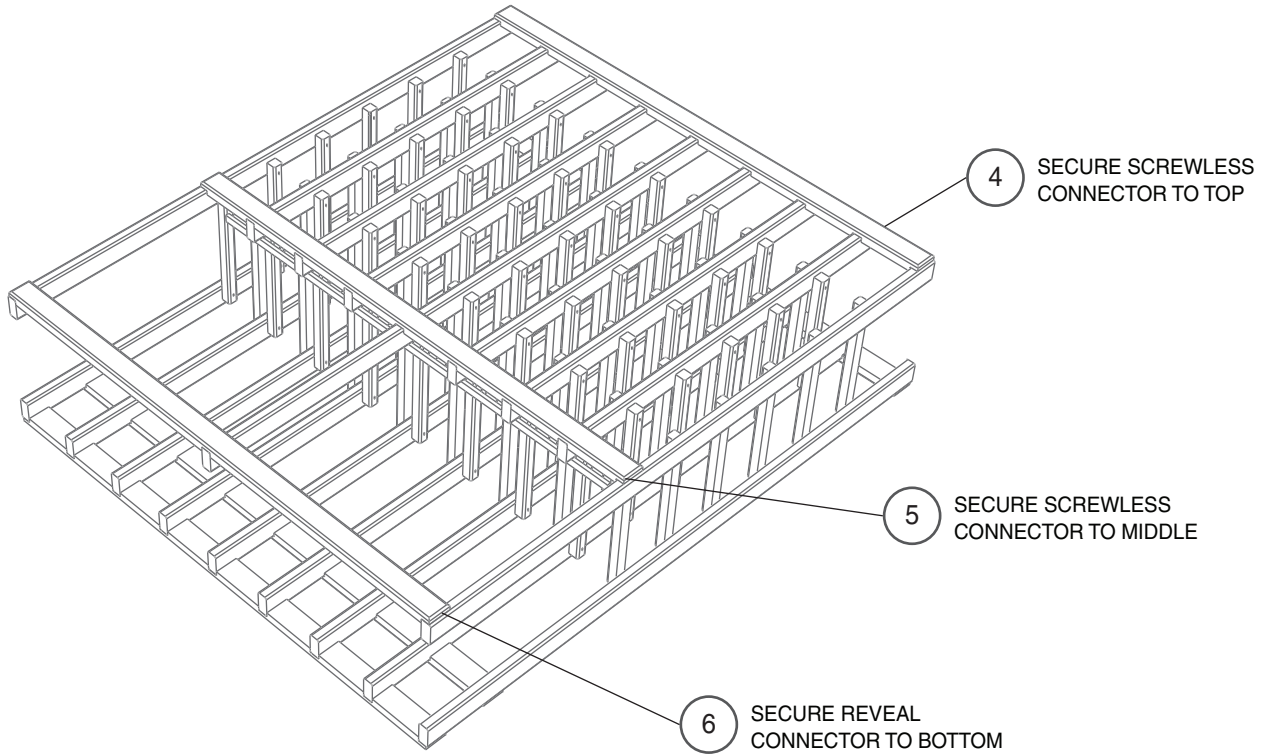

-
6. Stand your rack upright. Secure the display trays to the rack by adding a bead of wood glue to each of the two grooves on the back of the tray. Set the tray into place so that grooves rest on the lower reveal connector and the standard connector on the back of the rack. (figure 7)

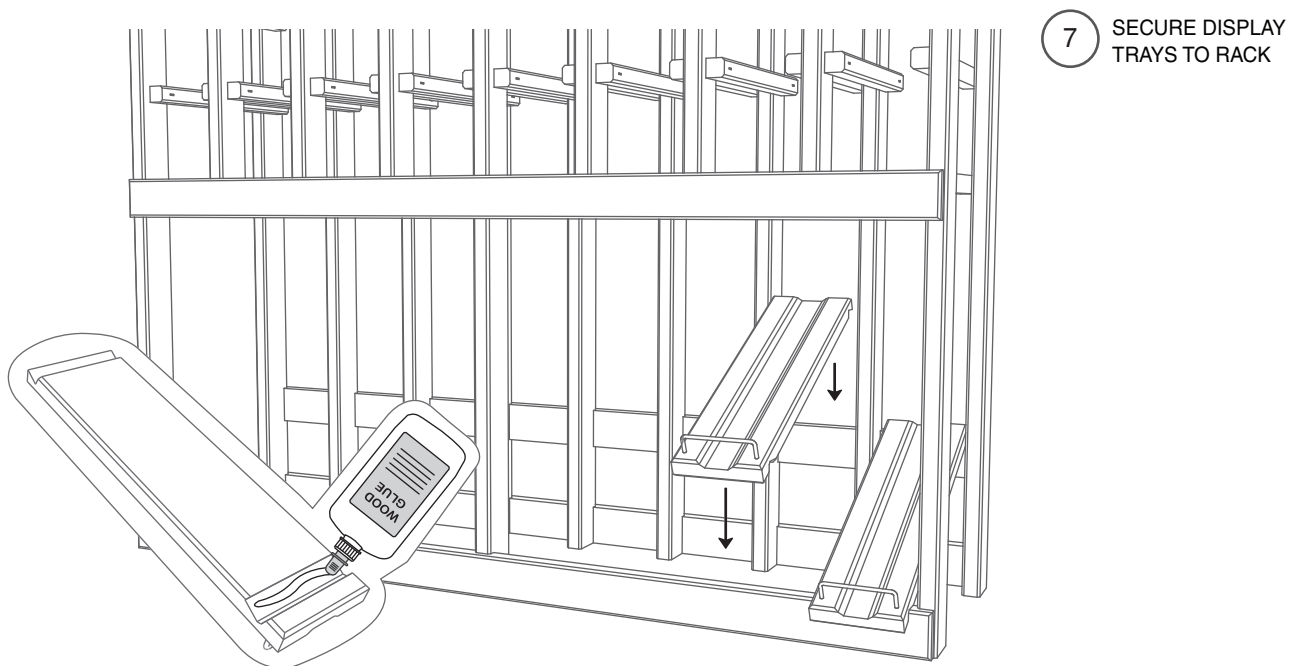



HIGH REVEAL RACK ASSEMBLY GUIDE

Questions?
888.373.6057

or visit
wineracksamerica.com

Page 5

7. If you purchased a Side Display High Reveal Rack, secure the side display piece to the rack by adding a bead of wood glue to each of the two grooves on the side display end pieces. Set the side display piece into place so that grooves rest on the lower reveal connector and the standard connector on the back of the rack. (figure 8)

8 SECURE SIDE
DISPLAY TO RACK
(OPTIONAL)

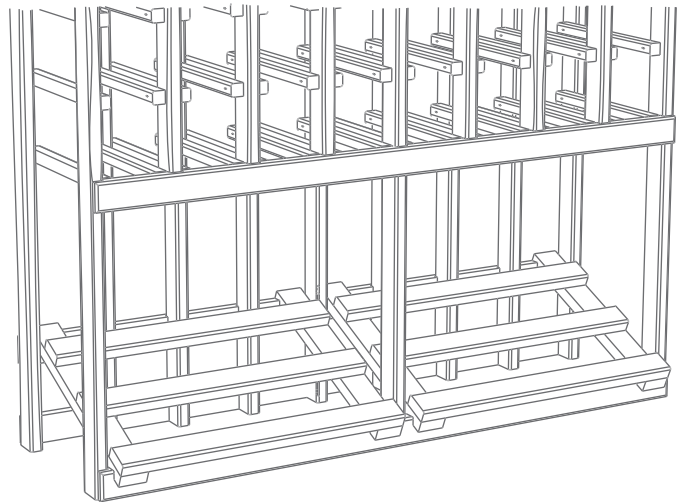
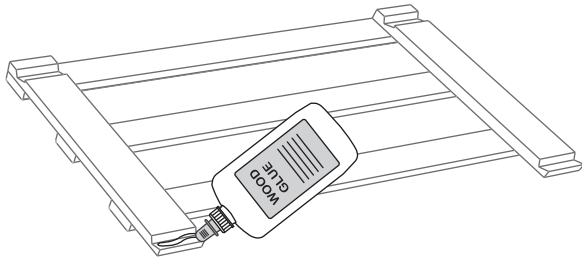

8. If your rack was purchased with an LED lighting strip, secure by removing the adhesive backing and placing strip directly above the display trays so that the strip is attached to the underside of the bottle support pieces on the ladders. The strip should be placed as close to the front of the rack as possible. (figure 9)
9. The assembly of your high reveal rack is now complete and you are ready to place the rack above any base rack of your choice. (figure 10)

9 SECURE LED
LIGHTING STRIP
(OPTIONAL)

10 SET ON
BASE RACK

