

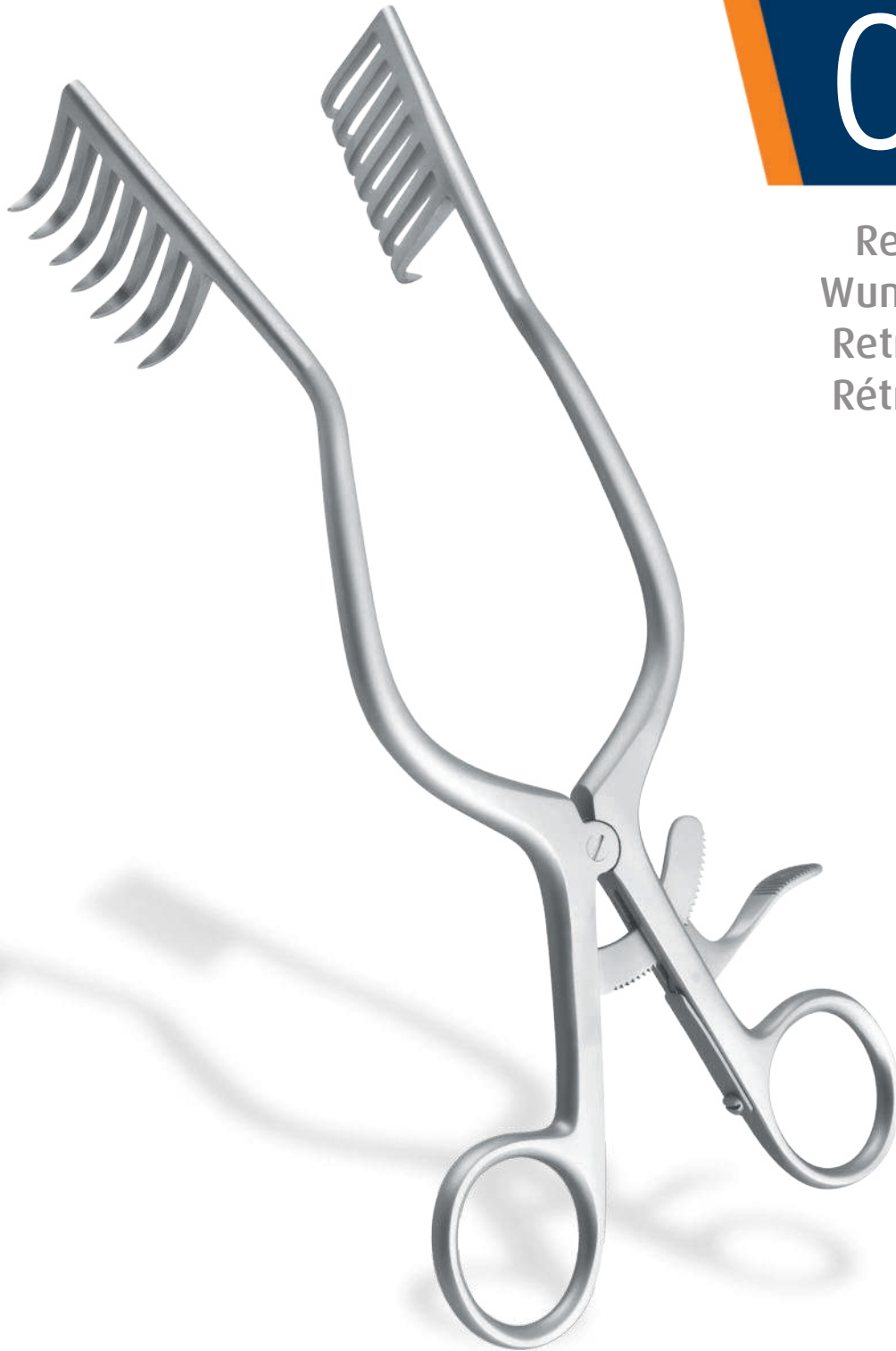

09

Retractors  
Wundhaken  
Retradores  
Rétracteurs





1/1  
Skin hook

1/2

Vickers

09-100-18 18.5 cm



1/1  
Bone hook

1/2

Vickers

09-102-17 17 cm



1/1  
Tendon hook

1/2

Vickers

09-104-17 17 cm



1/1

1/2

Vickers

09-106-02 16 cm



1/1

1/2

Vickers

09-106-03 16 cm



1/2

Vickers

09-108-12 - 09-108-16  
14.5 cm



1/1

09-108-12  
12 mm

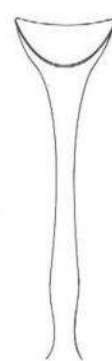

09-108-14  
14 mm

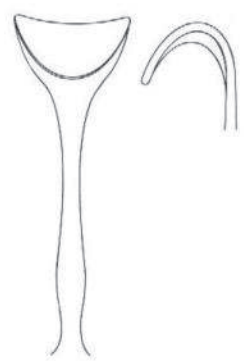

09-108-16  
16 mm

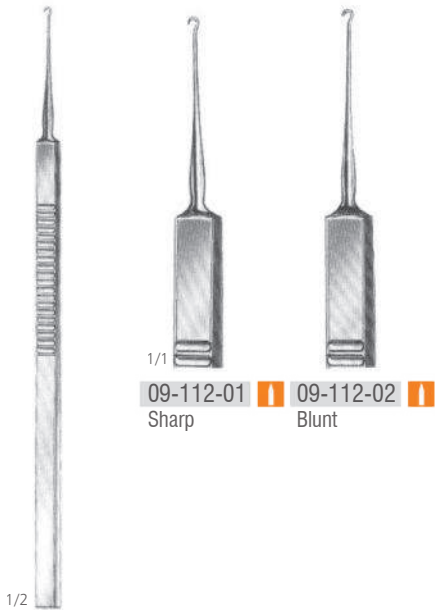

Graefe  
09-112-01 - 09-112-02  
16 cm

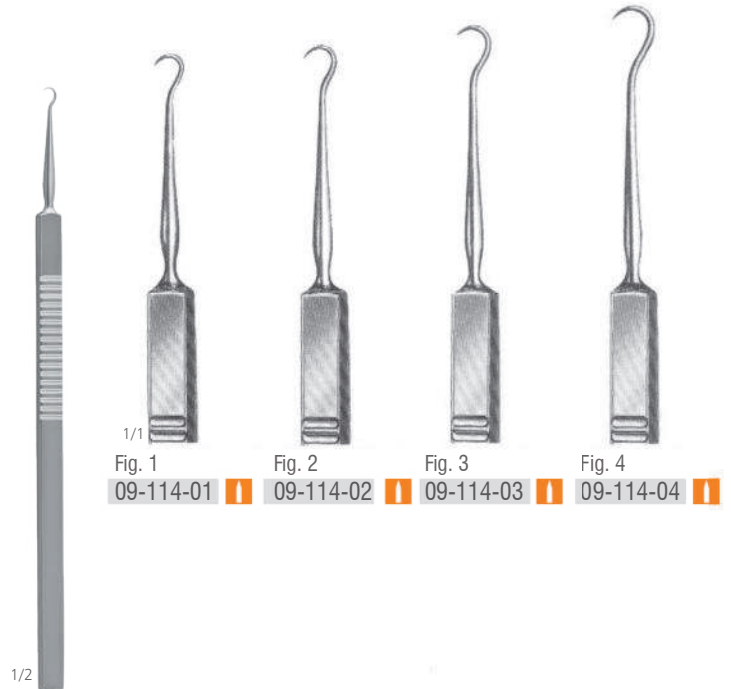

09-114-01 - 09-114-04  
16 cm  
Sharp

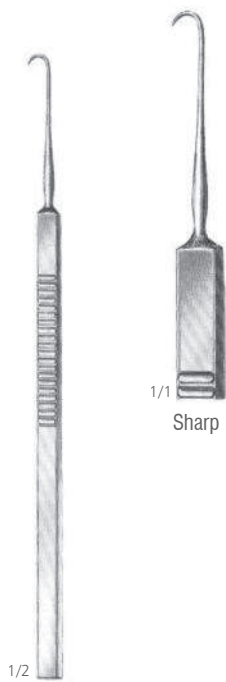

O'Connor  
09-116-16  
16 cm



Guthrie  
09-118-01 - 09-118-02  
16 cm  
Sharp

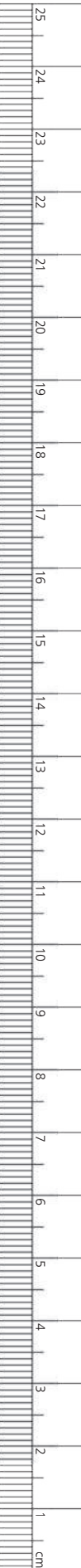



Kleinert - Kutz  
09-120-01 - 09-120-03  
16 cm

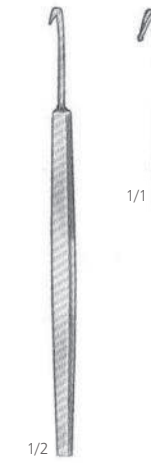

Moldestad  
09-122-13  
13 cm

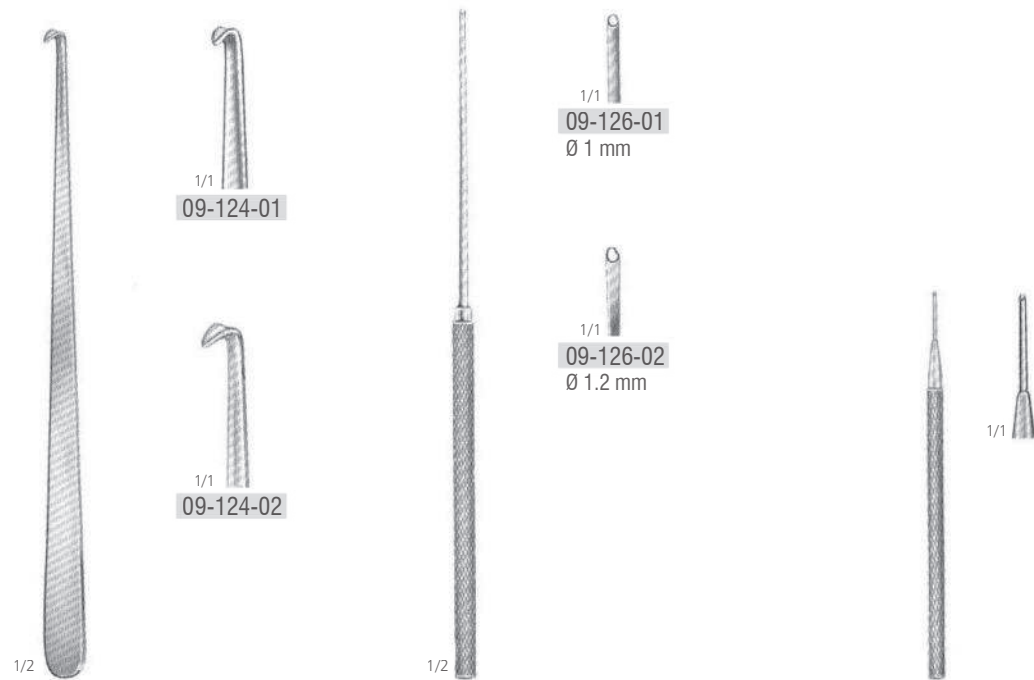

09-124-01 - 09-124-02  
17 cm

09-126-01 - 09-126-02  
18.5 cm

09-128-11  
11 cm

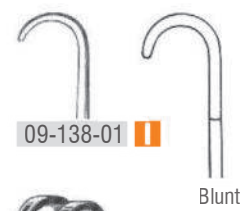
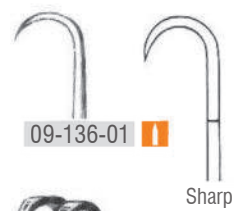
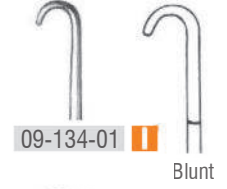
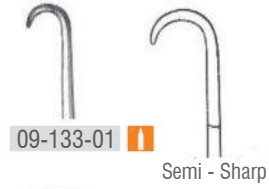
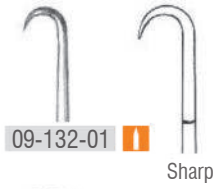
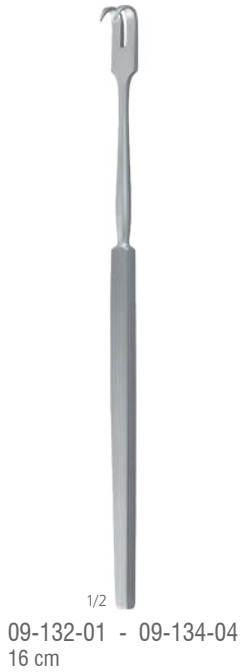

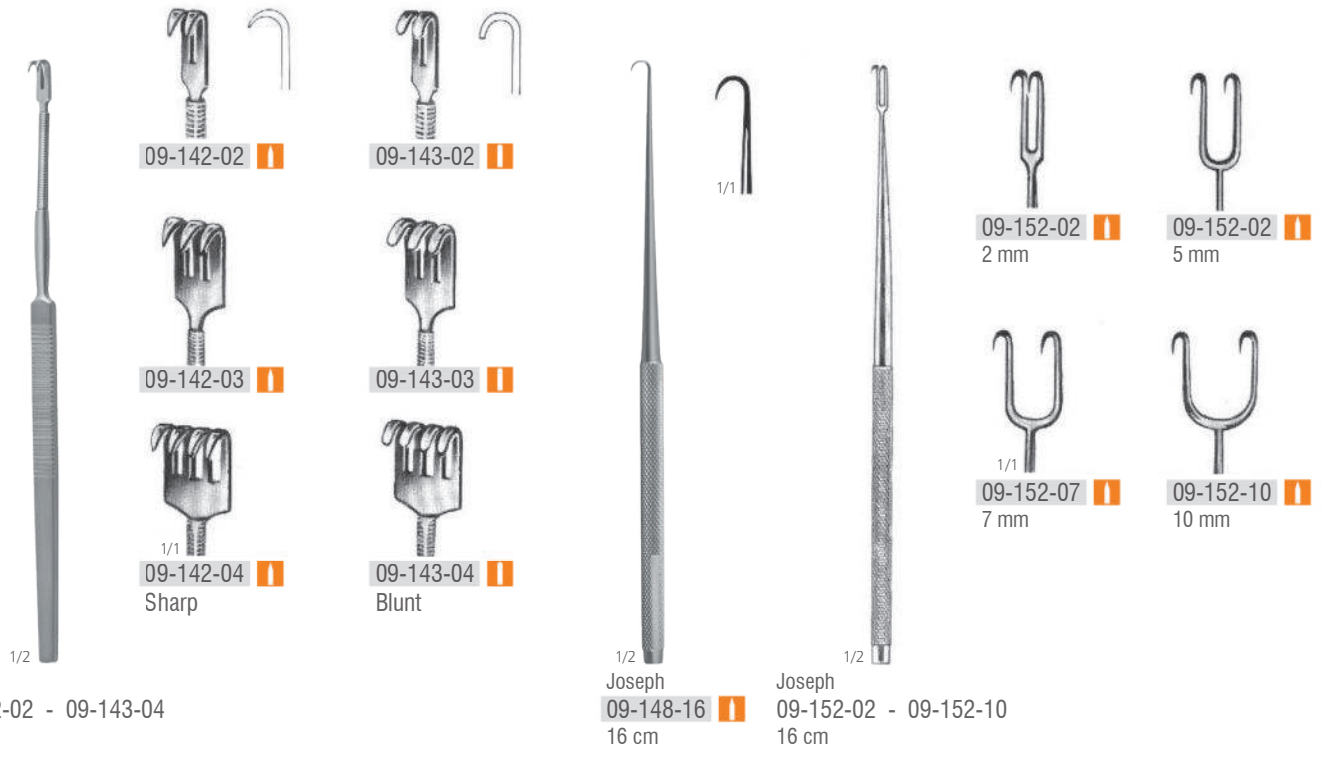

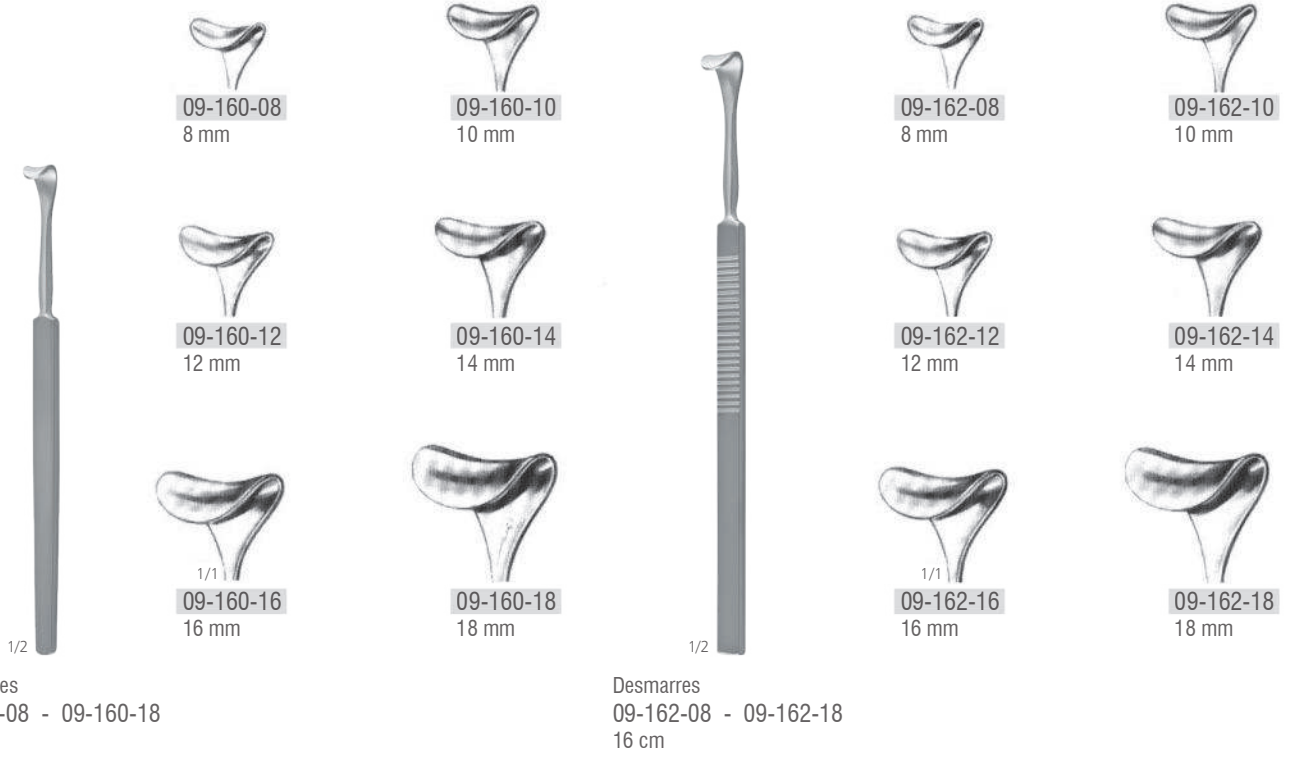

Retractors - Wundhaken - Retractores - Rétracteurs

09

Retractors  
Wundhaken  
Retractores  
Rétracteurs



Senn - Green  
09-180-01 - 09-180-02  
15 cm



Ragnell - Davis  
09-182-14  
14 cm

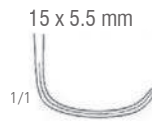

Baby - Senn  
09-184-15 - 09-185-15  
15 cm



Senn - Miller  
09-186-16 - 09-187-16  
16 cm

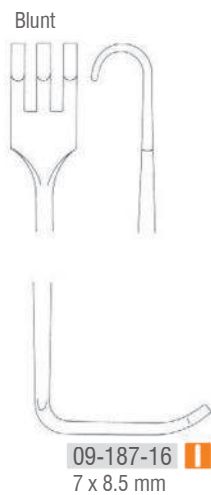
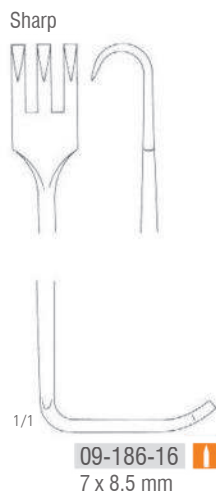

Cushing  
09-188-20  
20 cm

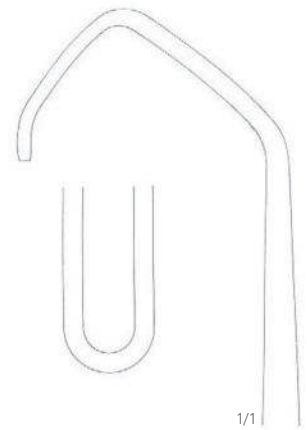



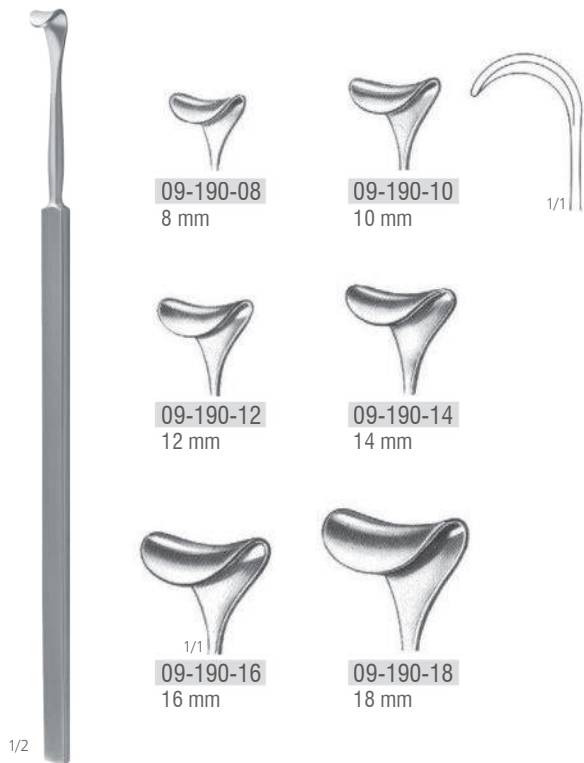

Cushing  
09-190-08 - 09-190-18  
20 cm

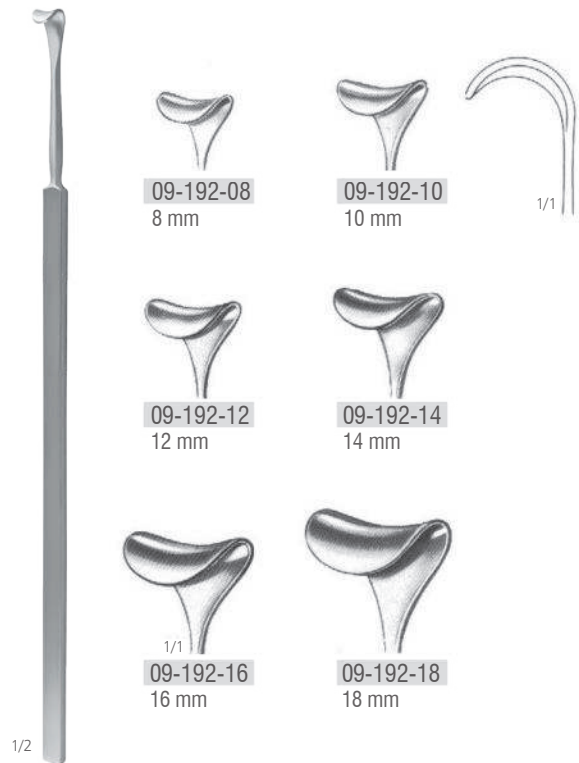

Cushing  
09-192-08 - 09-192-18  
20 cm



1/2

Gil - Vernet Type  
09-194-08 - 09-194-23  
24 cm

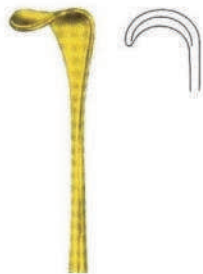

09-194-08  
8 mm



09-194-11  
11 mm



09-194-15  
15 mm



1/1  
09-194-17  
17 mm



09-194-20  
20 mm

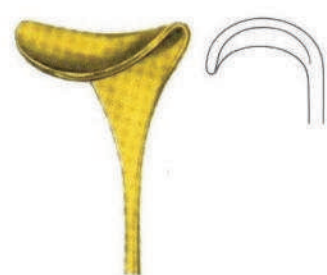

09-194-23  
23 mm



Brom  
09-196-01 - 09-196-02  
19 cm



Strandell - Stille  
09-198-01 - 09-198-02  
19 cm

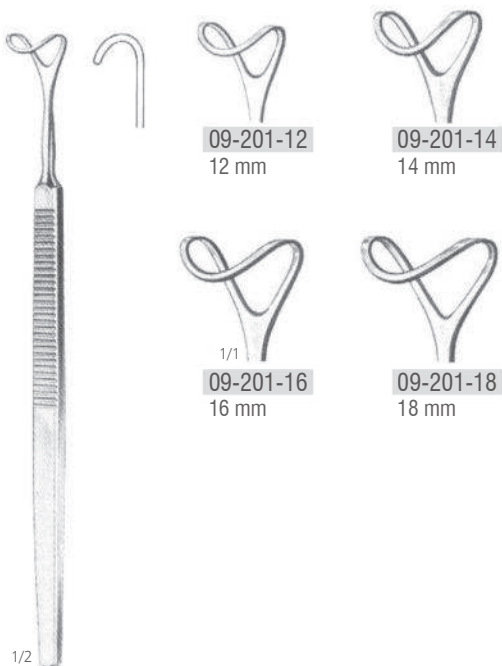

09-201-12 - 09-201-18  
16 cm



Mini - Langenbeck  
09-203-10 - 09-203-22  
16 cm

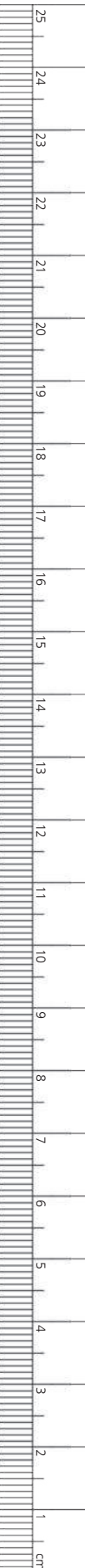



1/2

Volkman  
09-210-01 - 09-211-06  
21.5 cm

Sharp

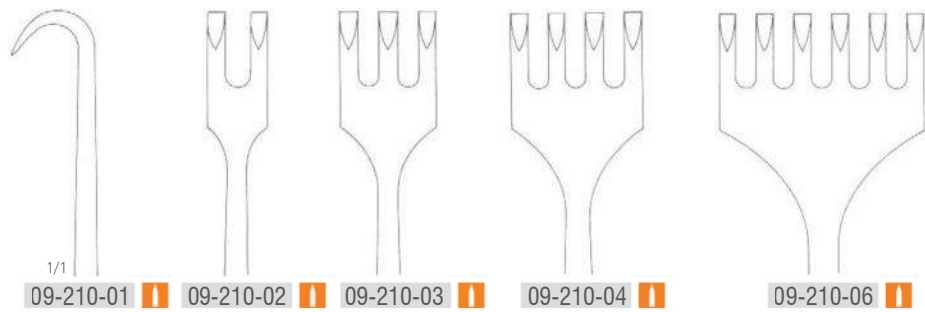

Blunt

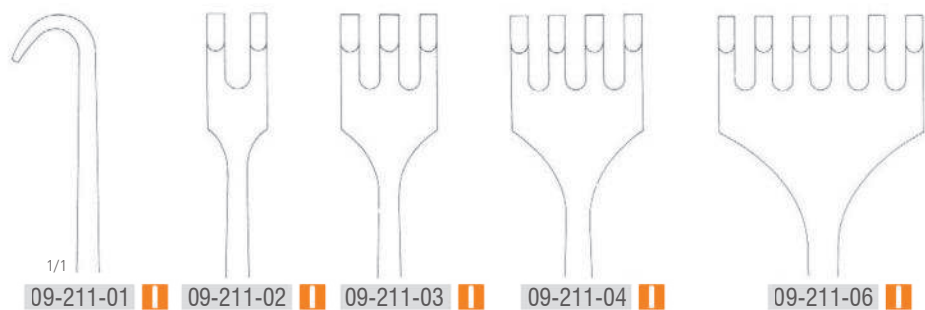



1/2

Volkman  
09-220-01 - 09-222-06  
22 cm



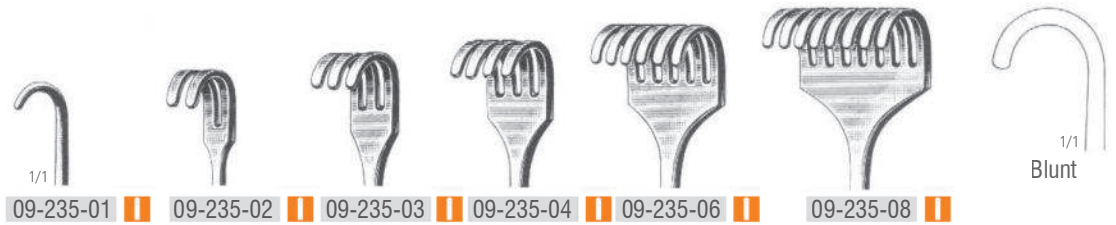

Kocher  
09-234-01 - 09-235-08  
22 cm



1/2

Martin  
09-240-02 - 09-241-06  
22 cm



1/2

09-240-02



09-240-03



09-240-04



09-240-06

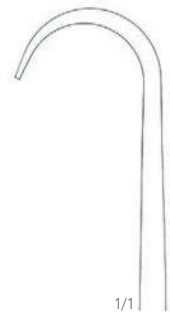

1/1

Sharp



1/2

09-241-02



09-241-03



09-241-04

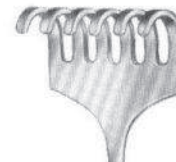

09-241-06

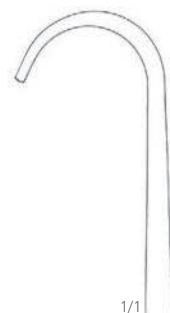

1/1

Blunt

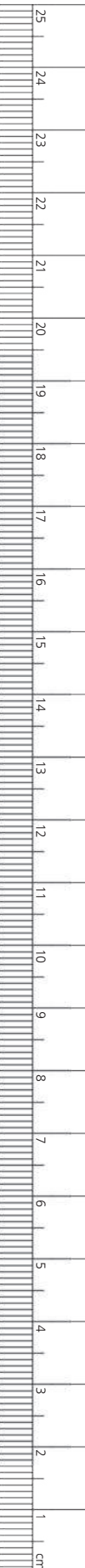

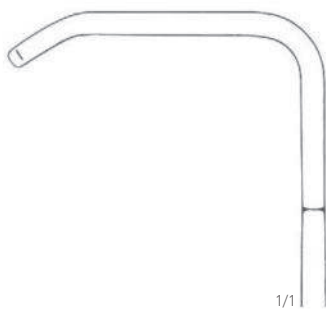

1/1



09-247-04   
36 x 60 mm



1/2  
09-246-04   
36 x 30 mm

Ollier  
09-246-03 - 09-247-04  
24 cm  
Blunt



1/1



33 x 20 mm

Wassmund  
09-251-02   
20.5 cm

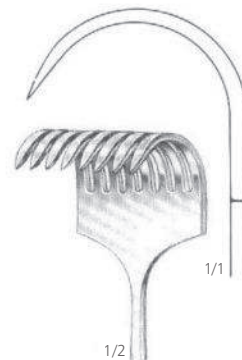

1/1

1/2  
09-256-08   
40 x 30 mm  
Sharp

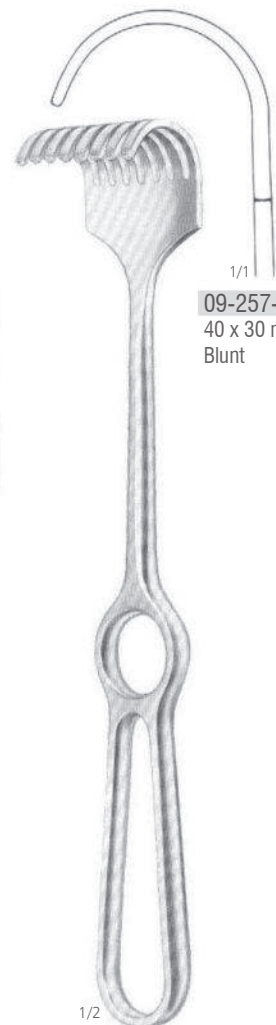

1/1

09-257-08   
40 x 30 mm  
Blunt

Koerte  
09-256-08 - 09-257-08  
23.5 cm





1/2

Israel  
09-261-01 - 09-269-07  
23.5 cm  
Blunt

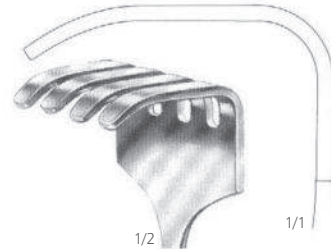

1/2

1/1

09-261-01 II  
40 x 40 mm

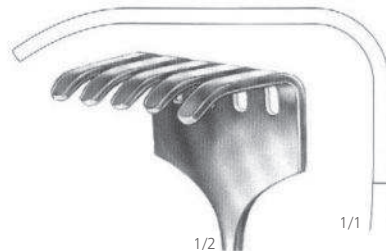

1/2

1/1

09-263-05 II  
40 x 50 mm

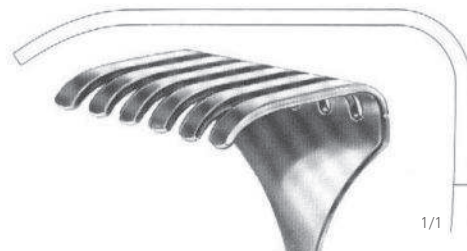

1/2

1/1

09-267-06 II  
50 x 60 mm

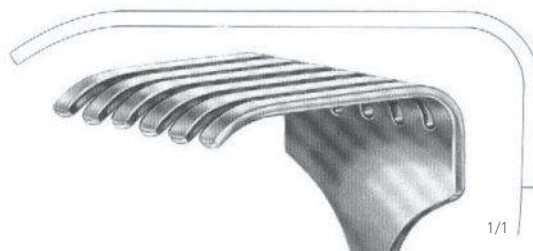

1/2

1/1

09-269-07 II  
70 x 70 mm

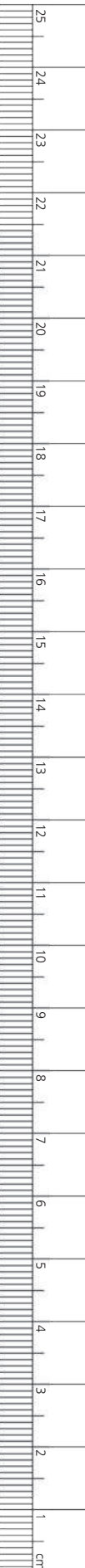





09-273-35   
35 x 40 mm

1/2  
Billroth  
09-273-35 - 09-273-45  
25 cm



09-273-43   
43 x 35 mm



09-273-45   
45 x 50 mm

09-277-01  
44 x 16 mm

09-277-02  
55 x 22 mm

09-277-03  
72 x 19 mm



1/2  
Sauerbruch  
09-277-01 - 09-277-03  
22.5 cm



1/2  
Langenbeck  
09-281-01 - 09-281-05  
22 cm



1/2  
Langenbeck  
09-283-01 - 09-283-05  
22 cm

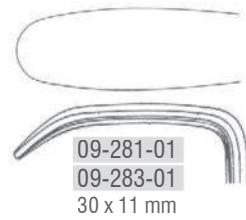

09-281-01  
09-283-01  
30 x 11 mm



09-281-02  
09-283-02  
30 x 14 mm

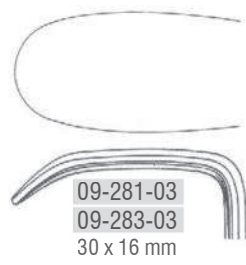

09-281-03  
09-283-03  
30 x 16 mm

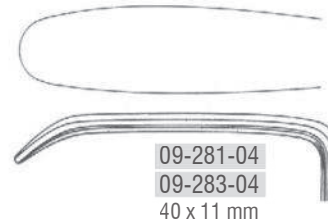

09-281-04  
09-283-04  
40 x 11 mm



09-281-05  
09-283-05  
50 x 11 mm

1/1

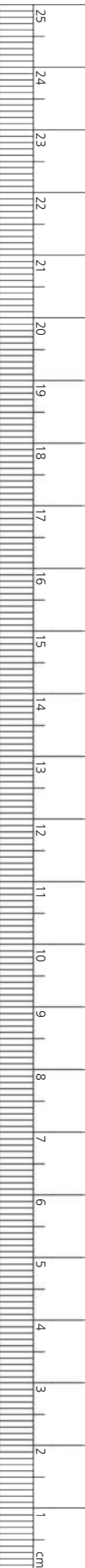



1/2  
Langenbeck  
09-285-21  
21.5 cm

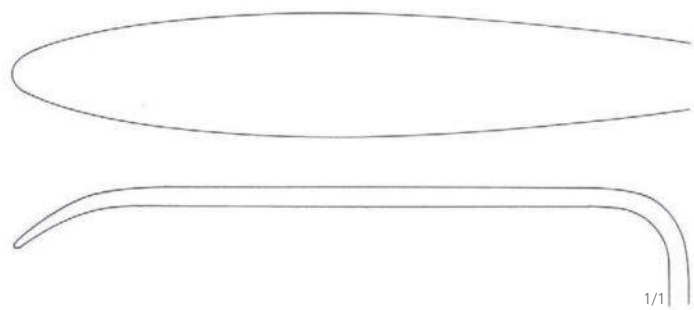

Langenbeck  
09-287-22  
22.5 cm

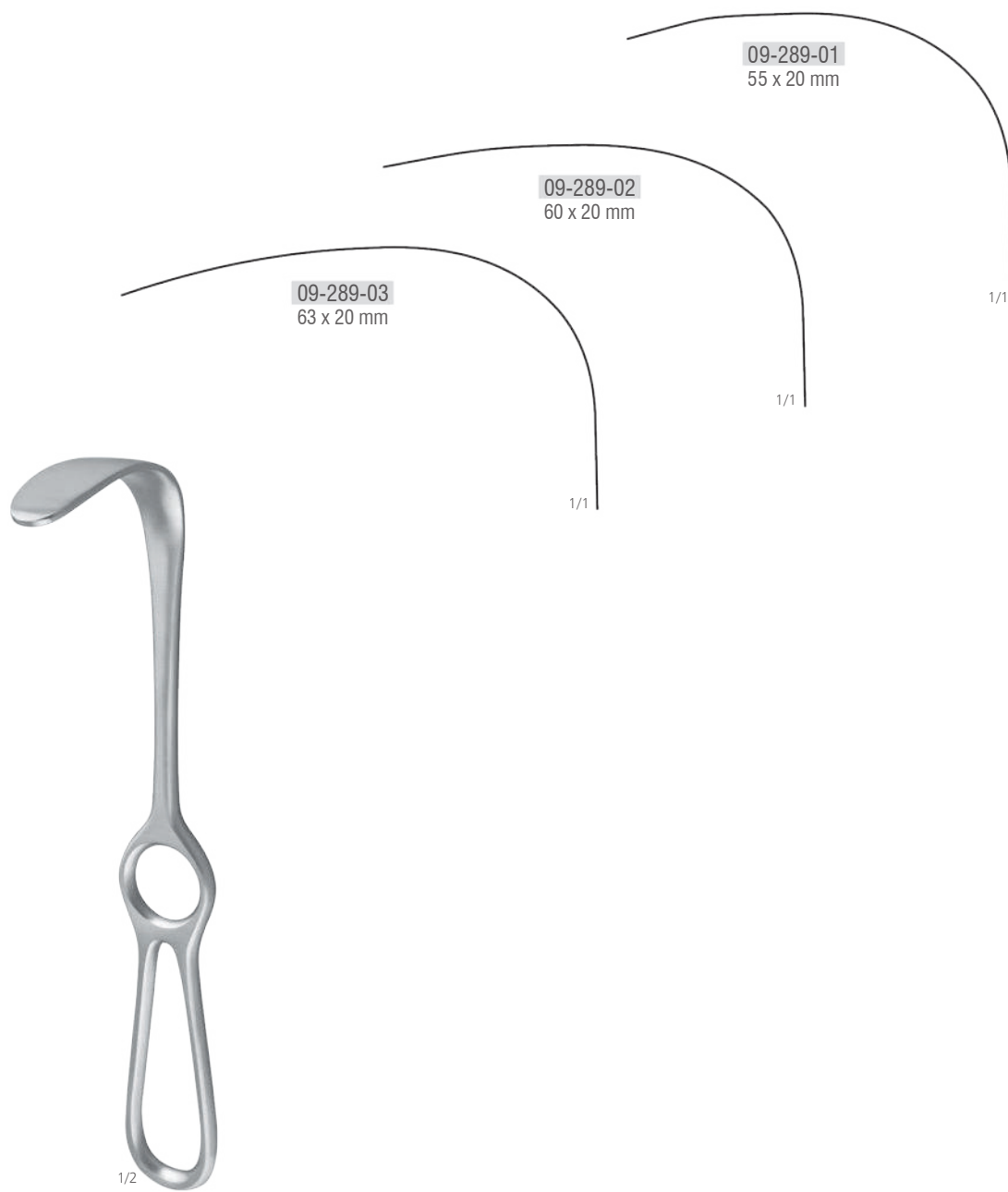

Langenbeck  
09-289-01 - 09-289-03  
21 cm

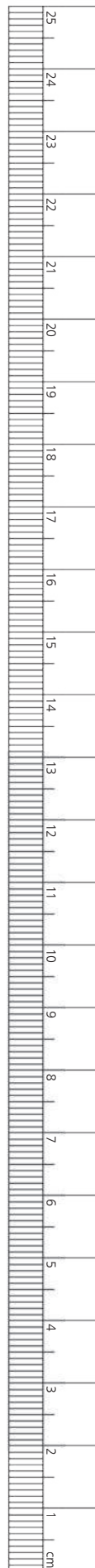



1/2

Kocher  
09-295-18 - 09-295-40  
23 cm

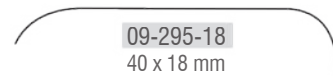

09-295-18  
40 x 18 mm

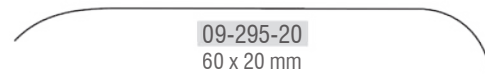

09-295-20  
60 x 20 mm

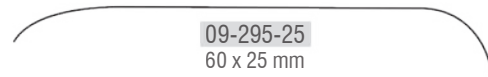

09-295-25  
60 x 25 mm

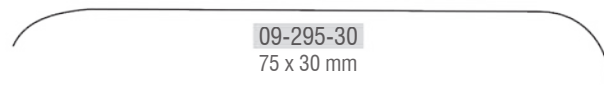

09-295-30  
75 x 30 mm

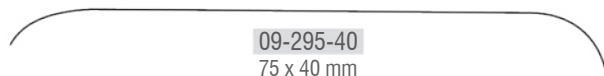

09-295-40  
75 x 40 mm

1/1

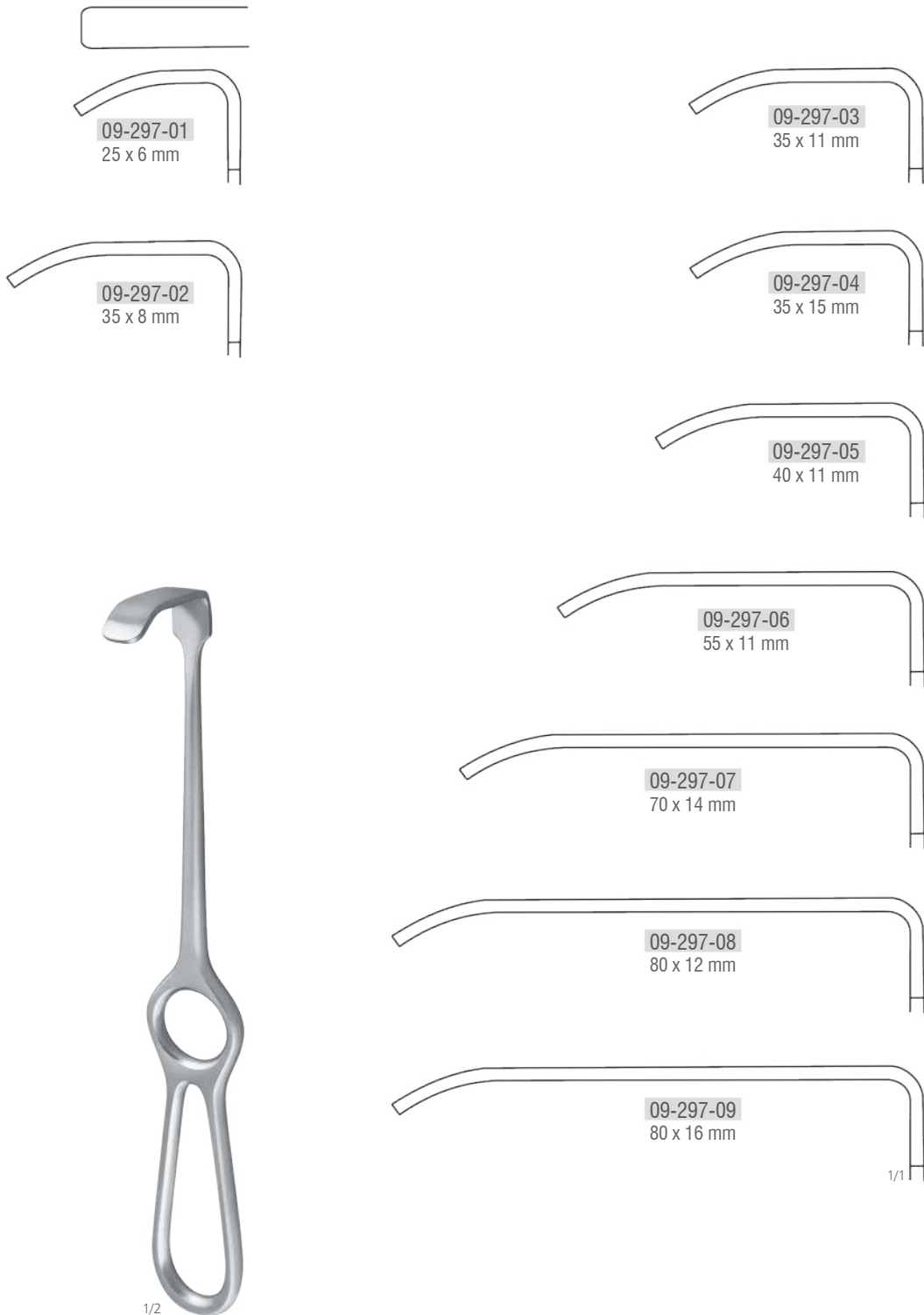

1/2  
Kocher - Langenbeck  
09-297-01 - 09-297-09  
22 cm



Kocher  
09-301-01 - 09-301-02  
20.5 cm

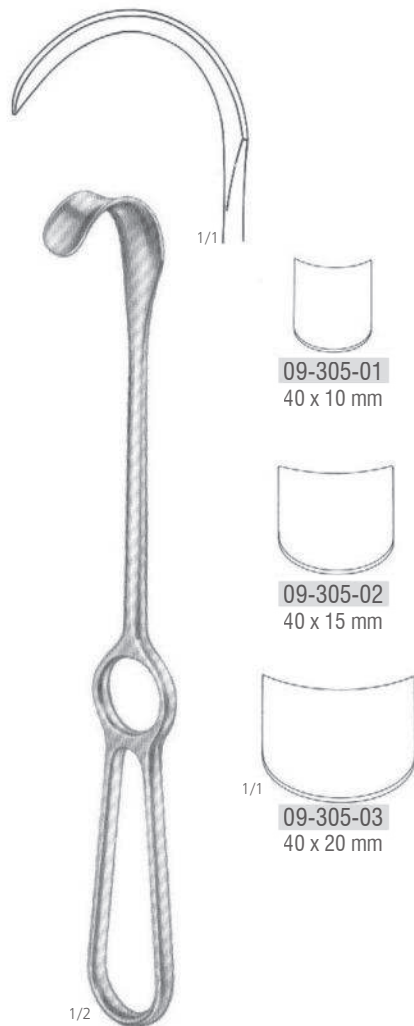

Kocher  
09-305-01 - 09-305-03  
22 cm

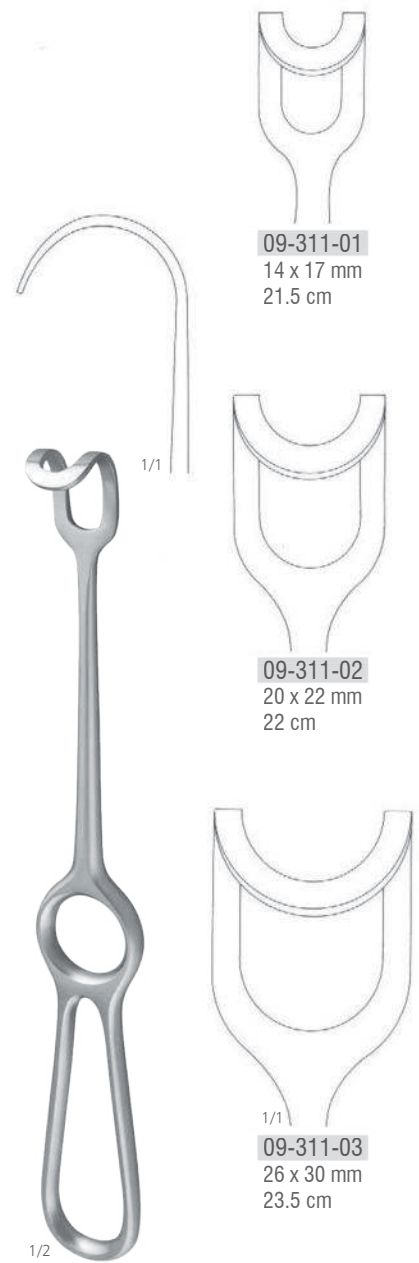

Middeldorpf  
09-311-01 - 09-311-03



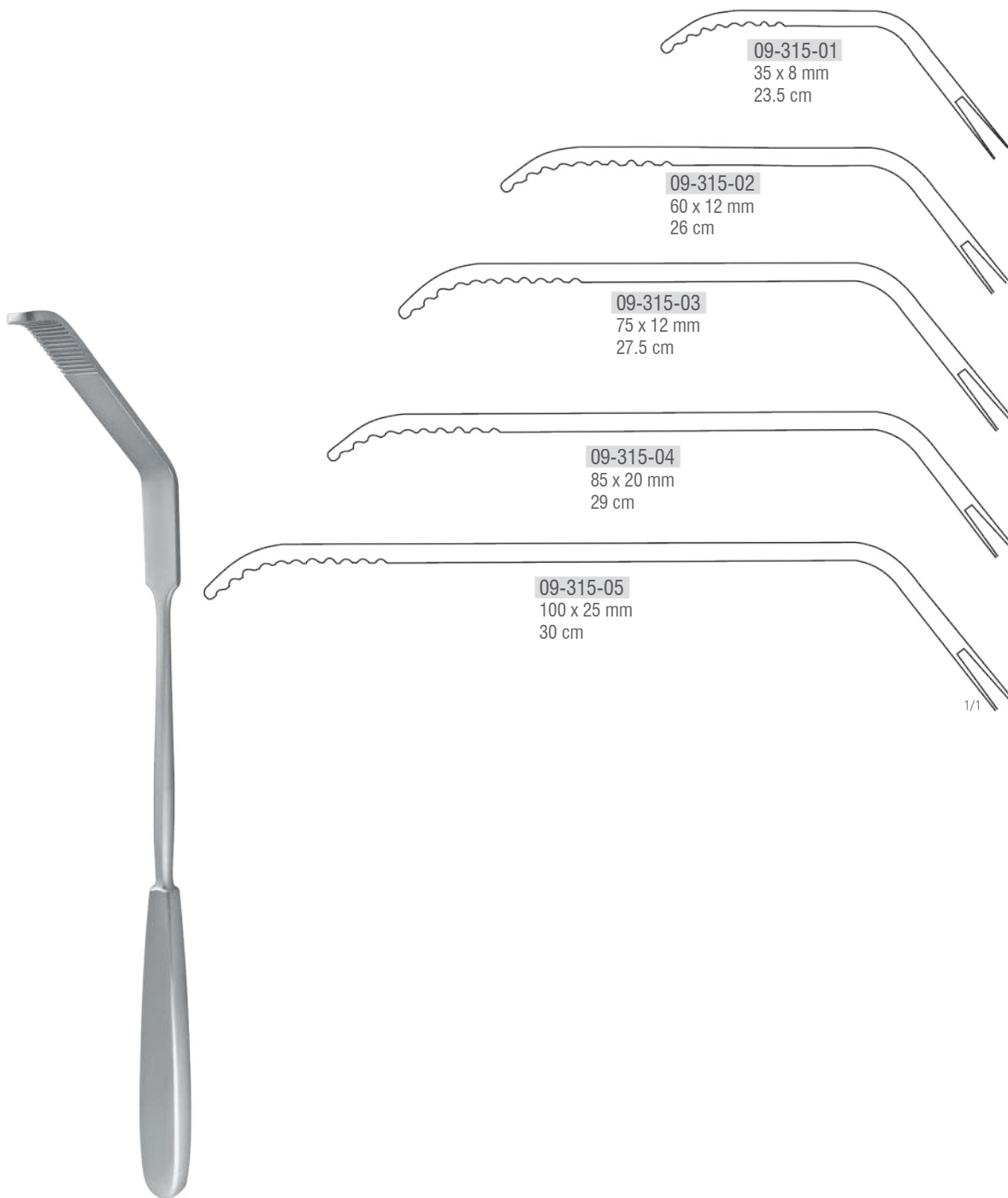

09-315-01  
35 x 8 mm  
23.5 cm

09-315-02  
60 x 12 mm  
26 cm

09-315-03  
75 x 12 mm  
27.5 cm

09-315-04  
85 x 20 mm  
29 cm

09-315-05  
100 x 25 mm  
30 cm

Zenker  
09-315-01 - 09-315-05

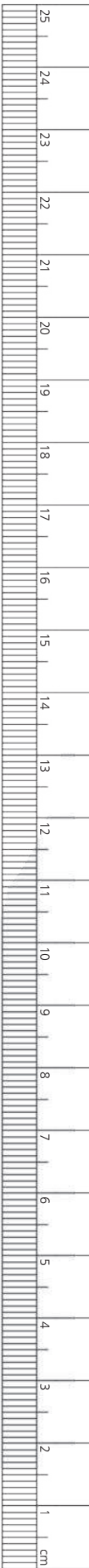

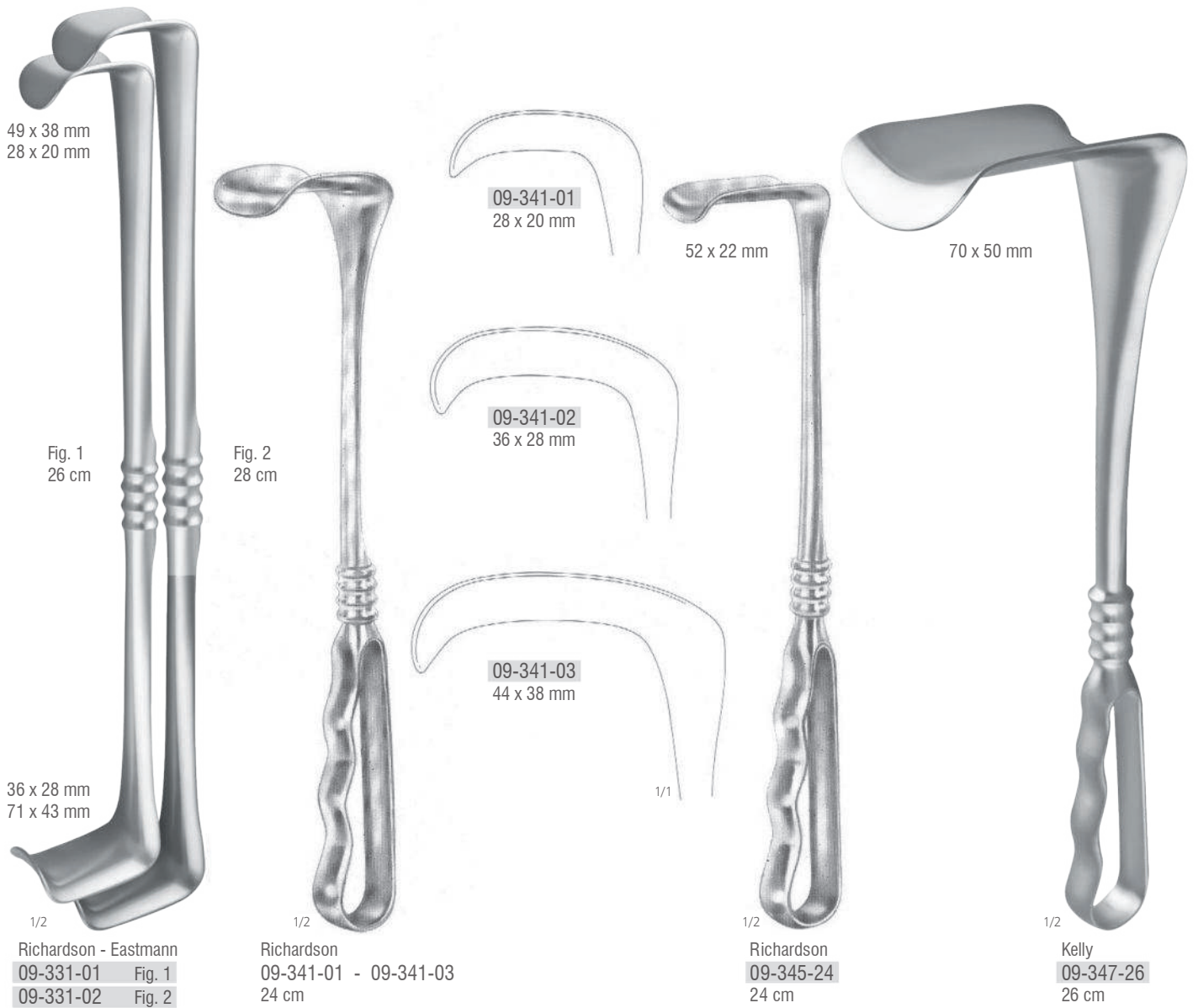



1/2  
Doyen - Stille  
09-351-01 - 09-351-03  
25 cm

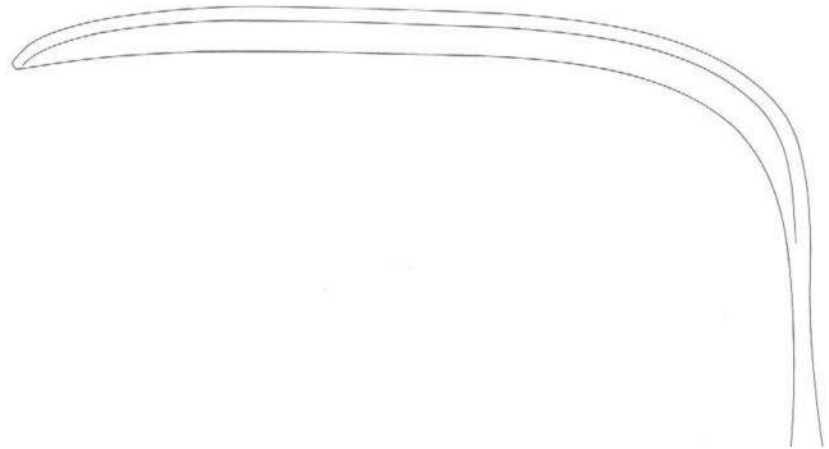

09-351-01  
90 x 28 mm

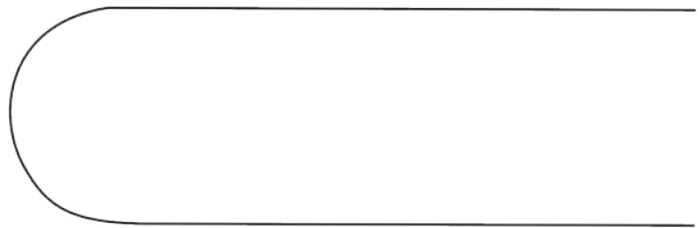

09-351-02  
105 x 30 mm

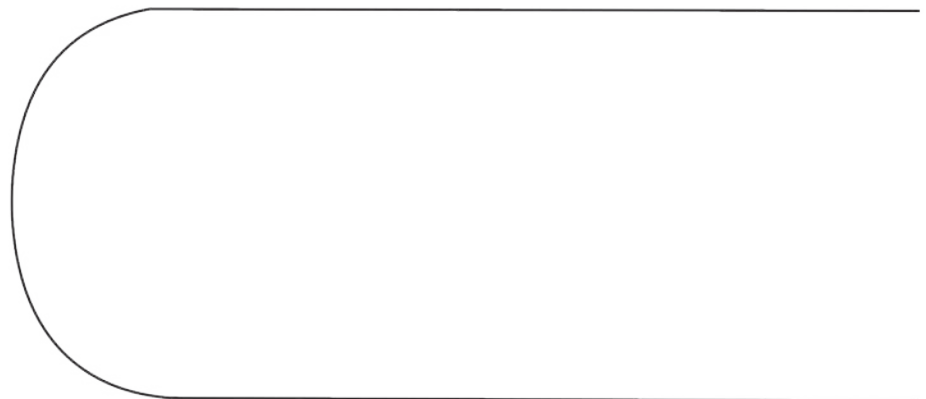

09-351-03  
120 x 52 mm

1/1

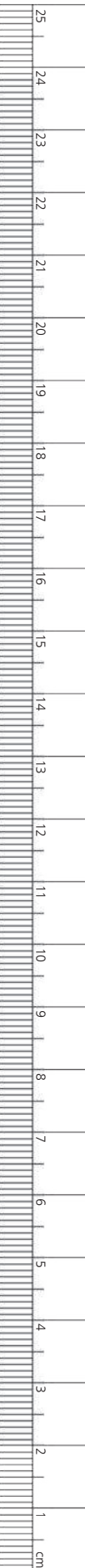



1/2

Hosel  
09-355-01 - 09-355-06  
26 cm

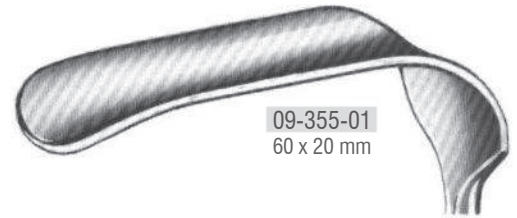

09-355-01  
60 x 20 mm

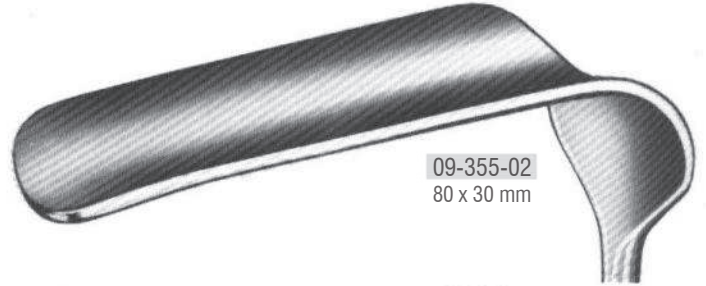

09-355-02  
80 x 30 mm

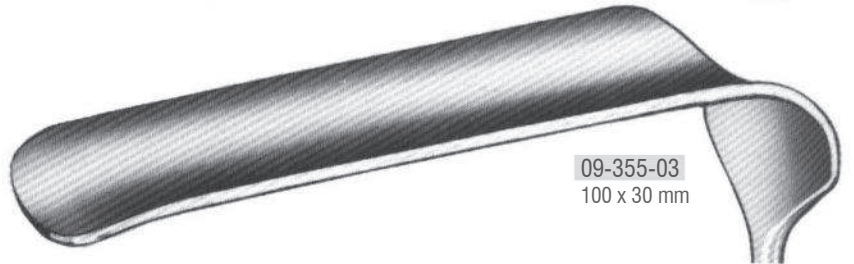

09-355-03  
100 x 30 mm

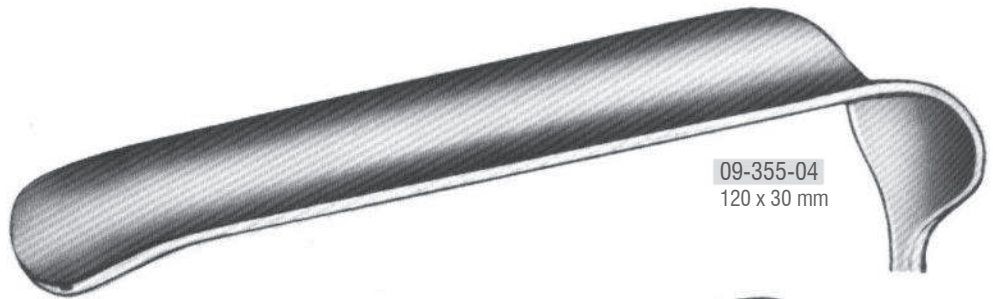

09-355-04  
120 x 30 mm

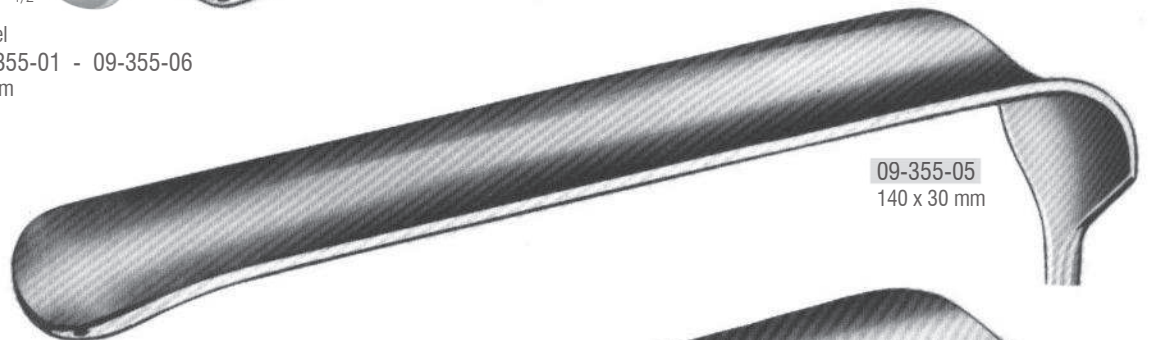

09-355-05  
140 x 30 mm

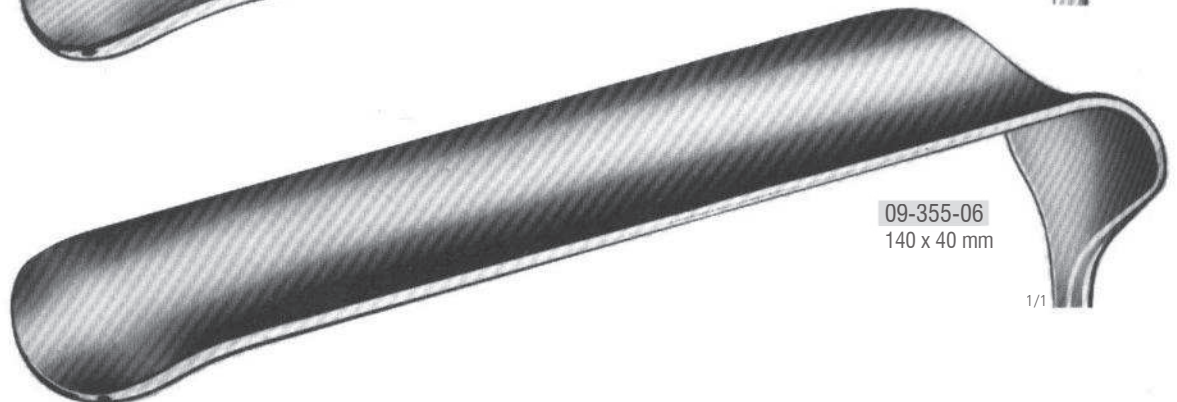

09-355-06  
140 x 40 mm

1/1

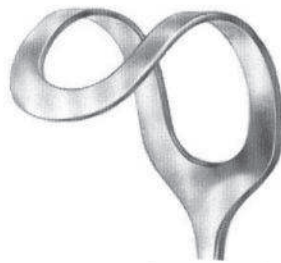

09-361-01  
45 x 45 mm

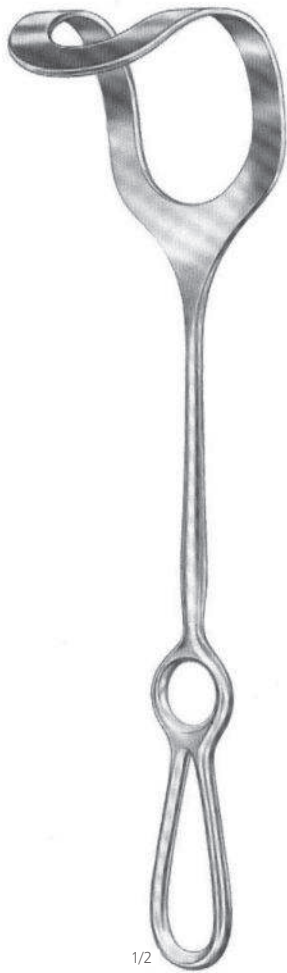

09-361-02  
45 x 50 mm

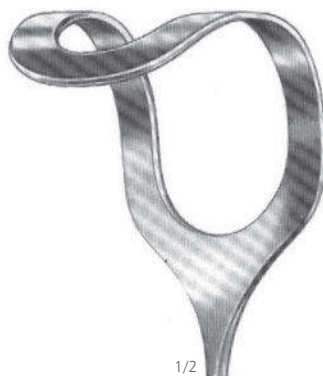

1/2  
09-361-03  
55 x 70 mm



1/2  
Middeldorpf  
09-361-01 - 09-361-03  
27.5 cm





Fritsch  
09-372-00 - 09-372-05  
23 cm

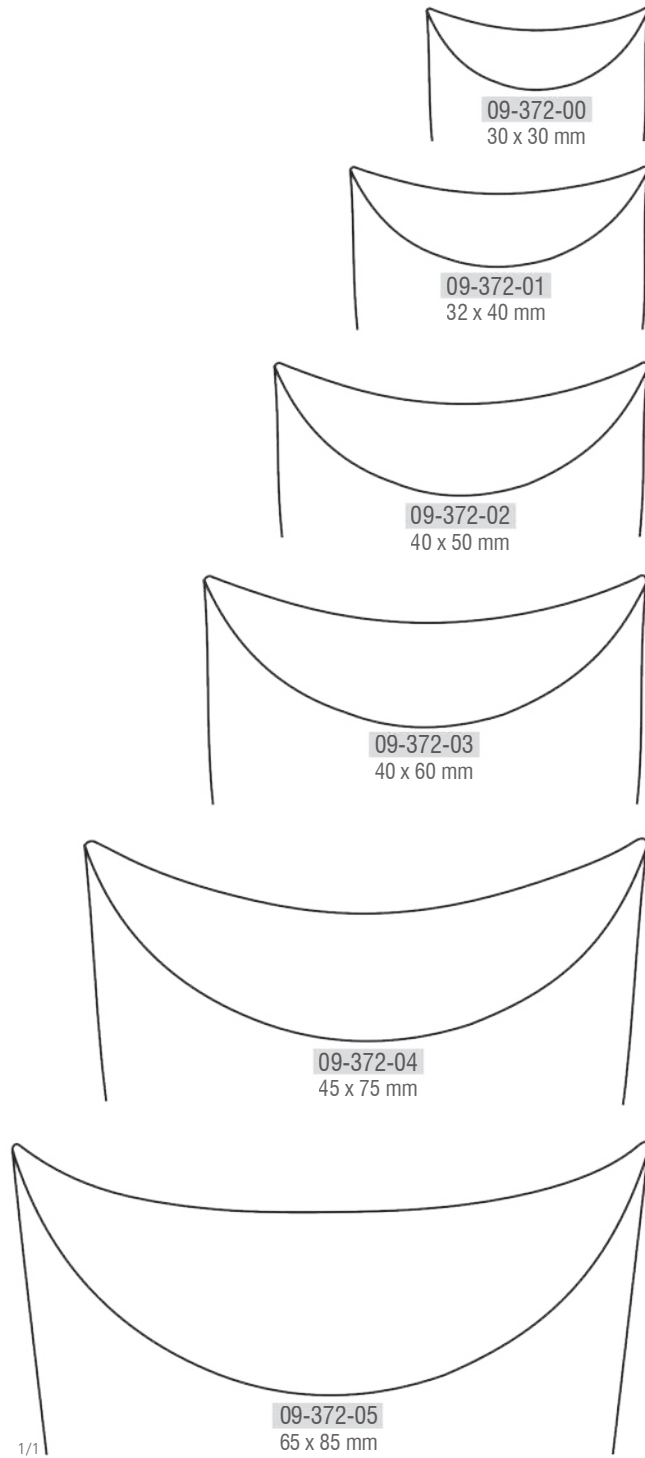



50 x 85 mm

1/2

Doyen  
09-381-25  
25 cm



70 x 25 mm

1/2

Kocher  
09-387-23  
23.5 cm



1/2

Kocher  
09-391-01 - 09-391-03  
25 cm  
09-391-01 80 x 45 mm  
09-391-02 80 x 55 mm  
09-391-03 80 x 65 mm

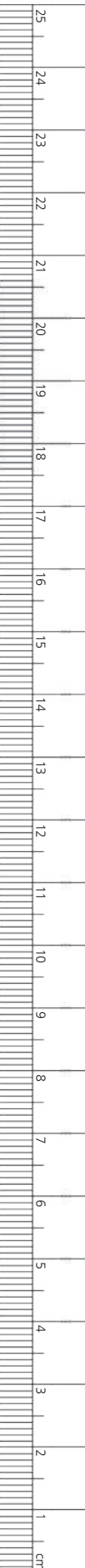

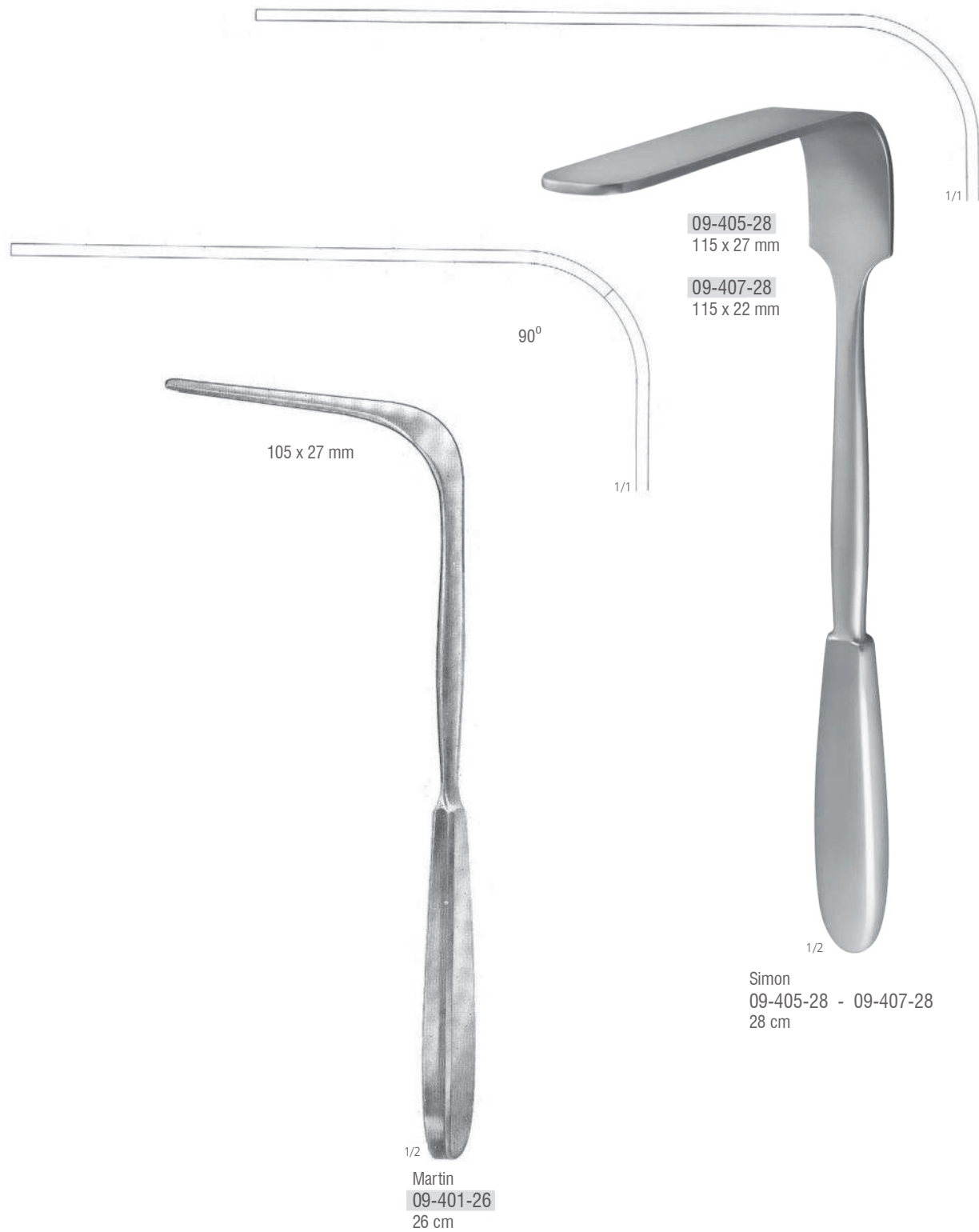



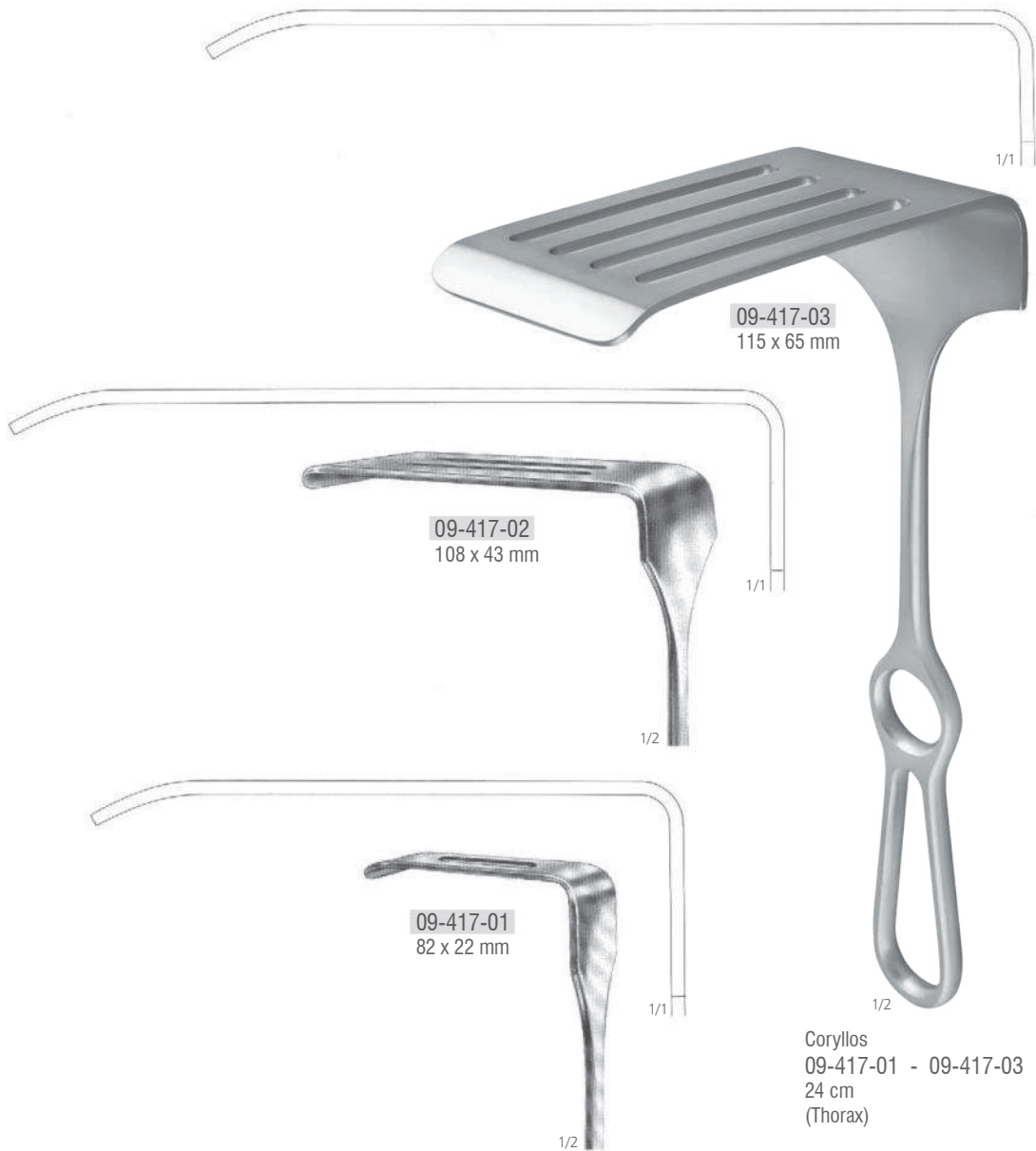



28 x 6 mm

1/1

1/2

Lahey  
09-421-19  
19 cm



12 x 14 mm

1/1

1/2

Little  
09-429-20  
20 cm



1/2

Doyen - Stille  
24 cm

09-425-15	90 x 15 mm
09-425-20	90 x 30 mm
09-425-30	90 x 30 mm
09-425-35	110 x 35 mm
09-425-40	110 x 40 mm
09-425-55	120 x 55 mm

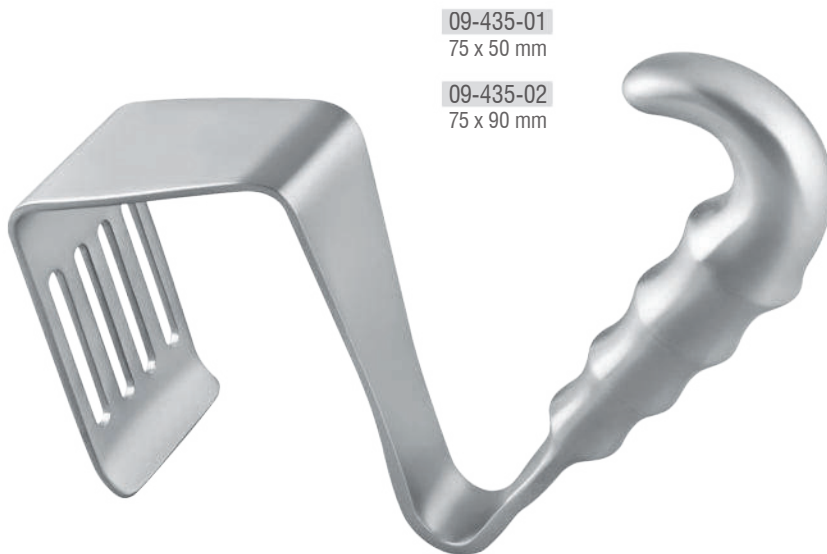

09-435-01  
75 x 50 mm

09-435-02  
75 x 90 mm

Davidson  
09-435-01 - 09-435-02  
16 cm  
(Specula)

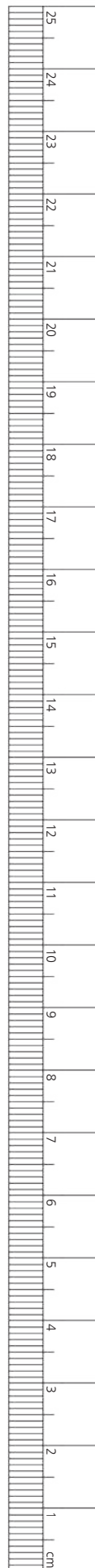



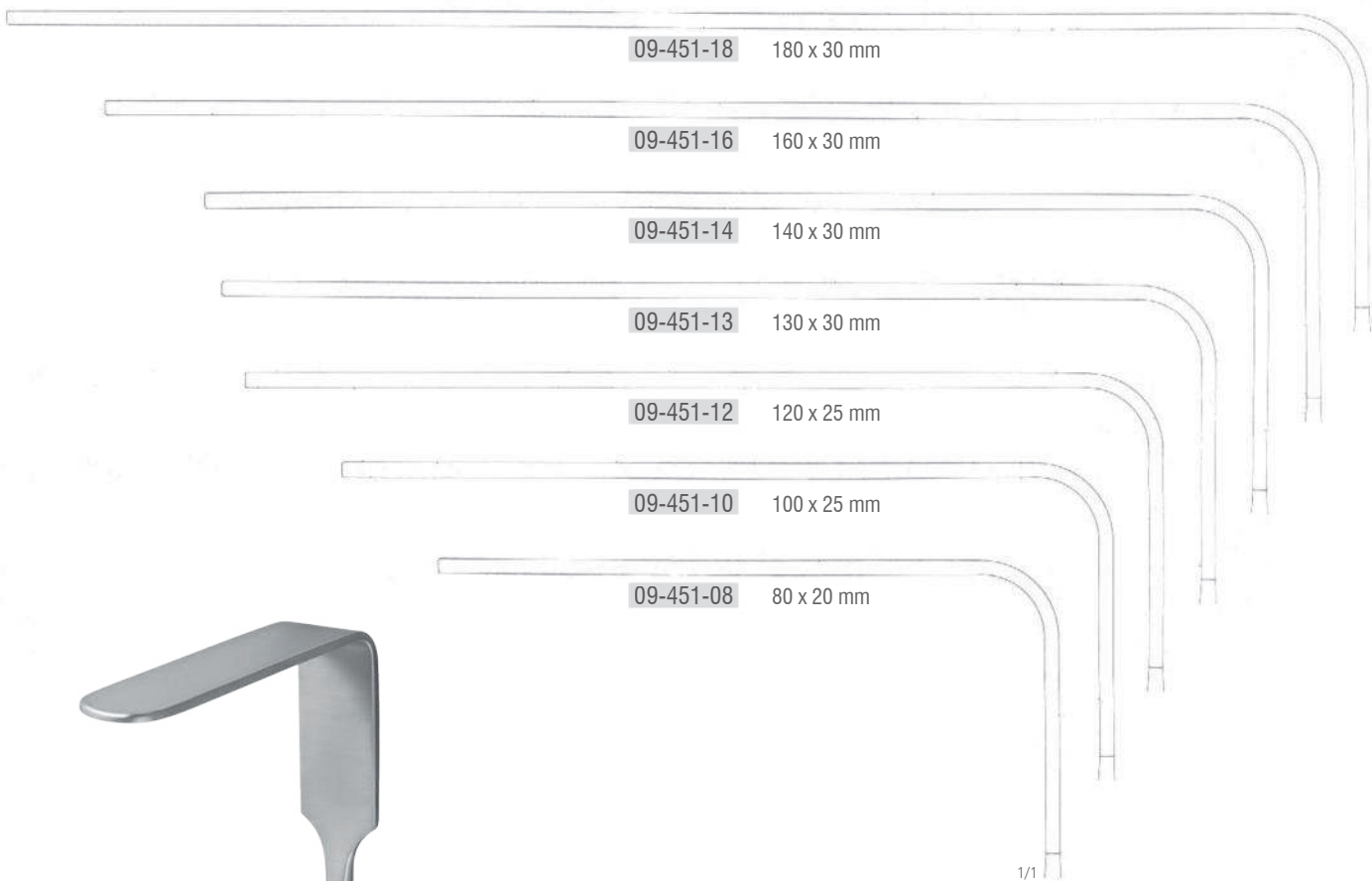

Brunner  
09-451-08 - 09-451-18  
25 cm

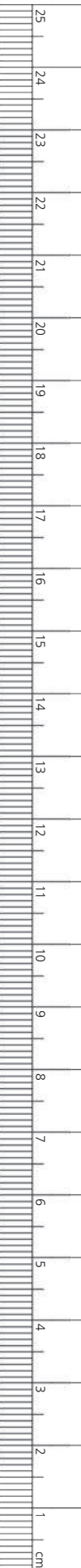

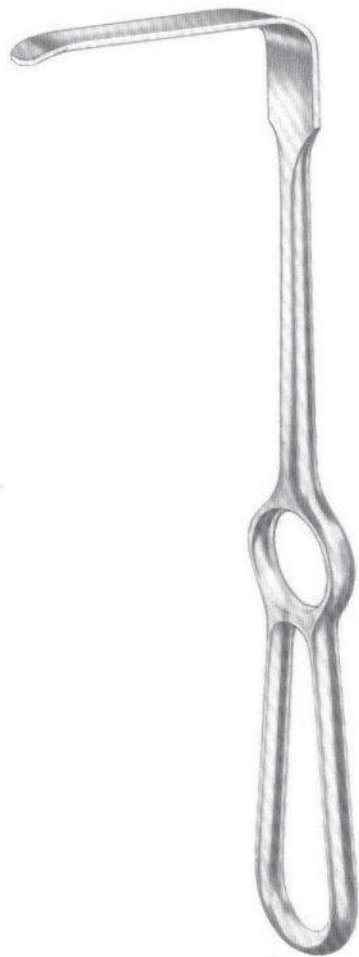
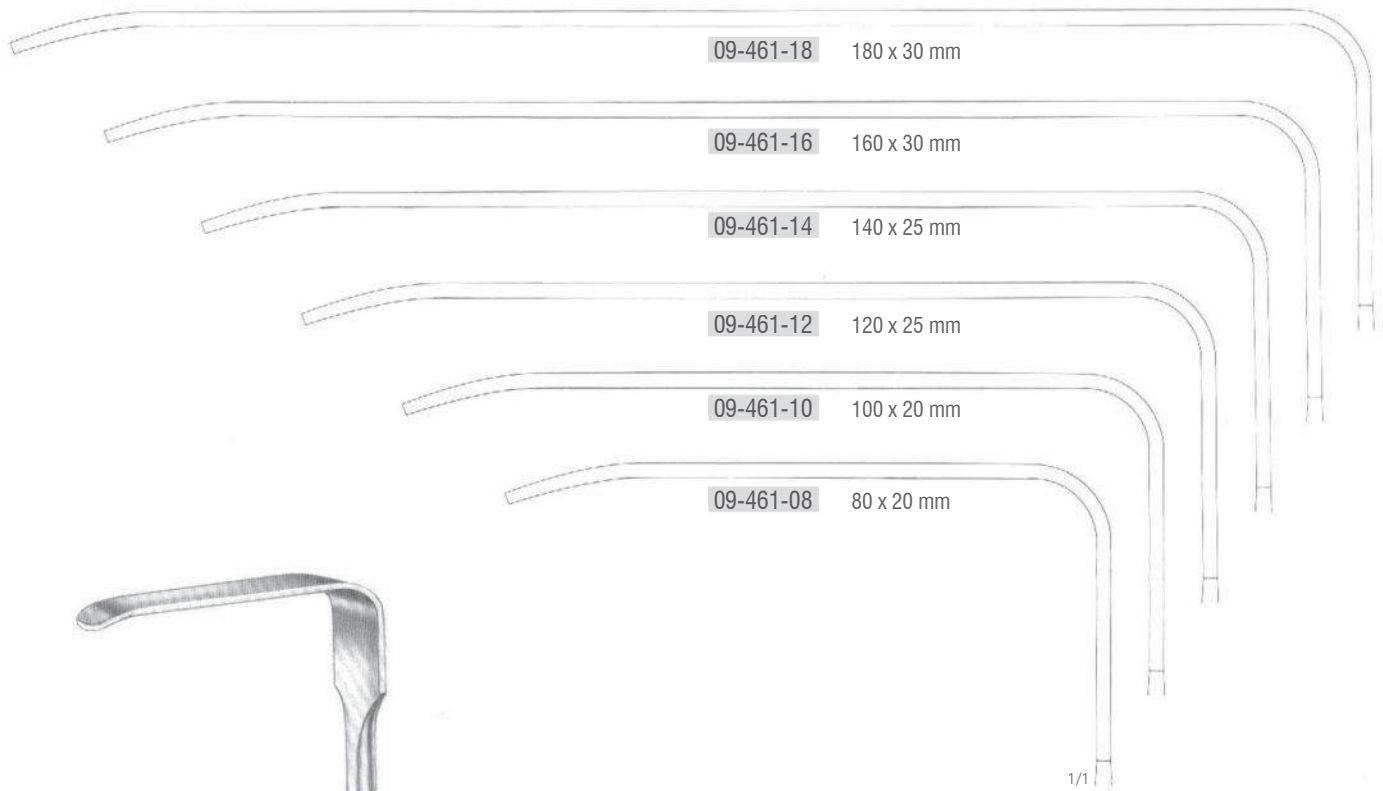

Brunner  
09-461-08 - 09-461-18  
25 cm



1/2  
Ross  
09-467-01 - 09-467-06  
25 cm  
(Aorta)



Crawford  
09-466-01 - 09-466-02  
19 cm  
(Aorta)

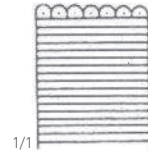

09-466-01  
15 x 15 mm

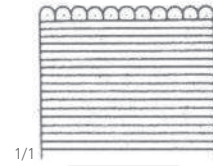

09-466-02  
15 x 23 mm



09-467-01  
Fig. 1



09-467-02  
Fig. 2



09-467-03  
Fig. 3

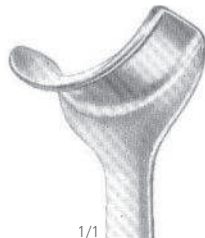

1/1  
09-467-04  
Fig. 4

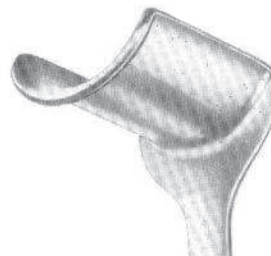

09-467-05  
Fig. 5

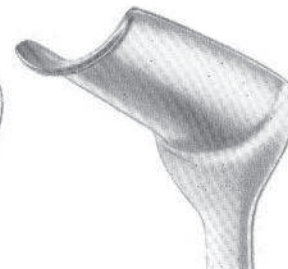

09-467-06  
Fig. 6

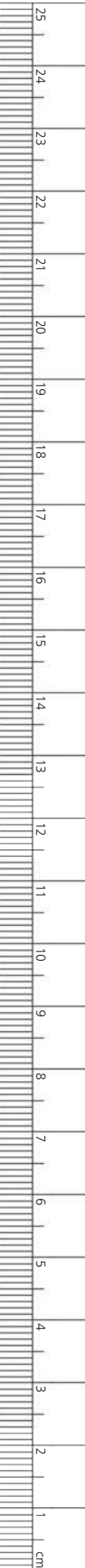

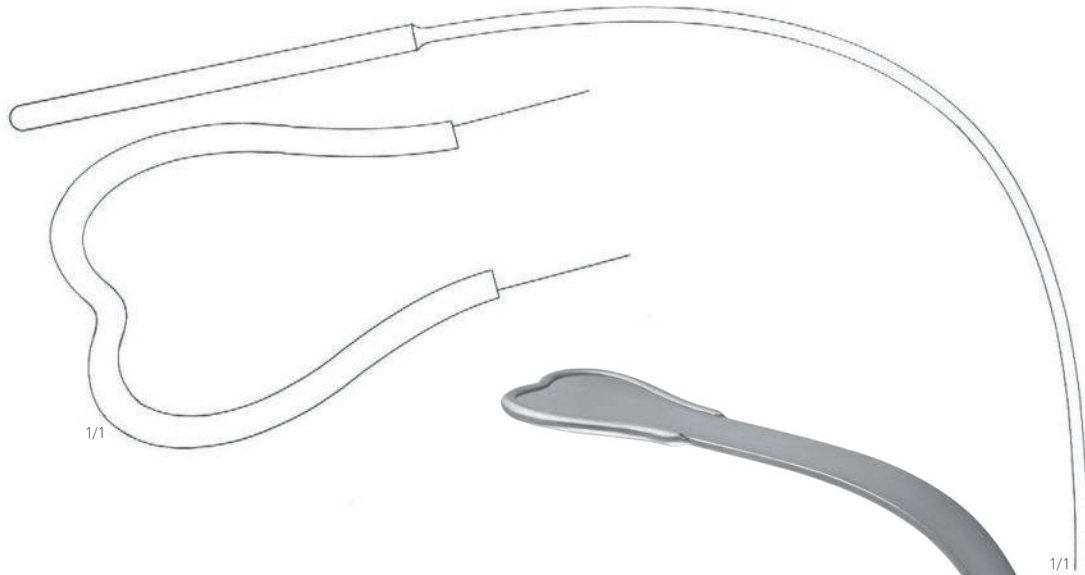

64 x 60 mm

Tuffier  
09-472-23  
23 cm



Harrington  
09-476-40 127 x 40 mm  
09-476-62 127 x 62 mm  
32 cm



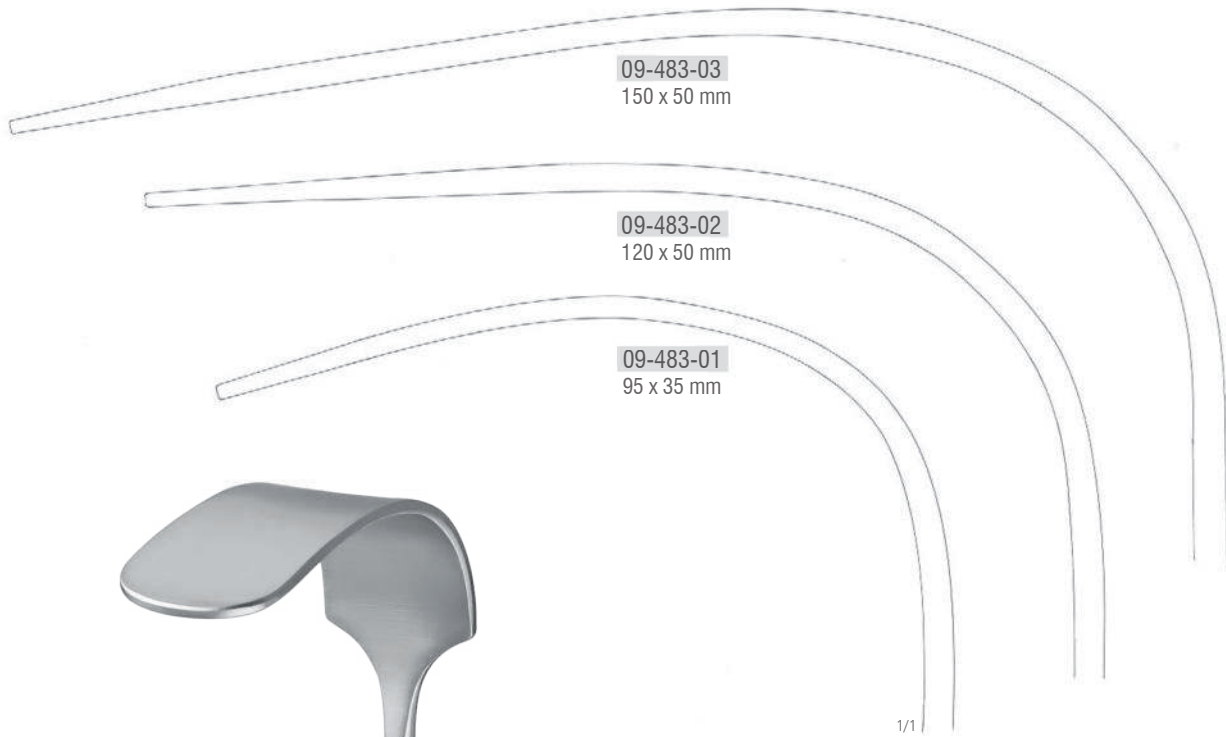

Mikulicz  
09-483-01 - 09-483-03  
25 cm



85 x 50 mm

1/2

Mikulicz  
09-487-26  
26 cm

1/1

1/2

Kelly

09-491-01	160 x 39 mm
09-491-02	160 x 57 mm
09-491-03	190 x 38 mm
09-491-04	190 x 57 mm
27 cm	



Polloson  
09-501-27  
27 cm

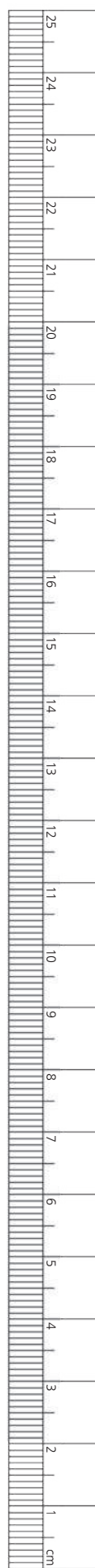



Polloson  
09-503-26  
26 cm





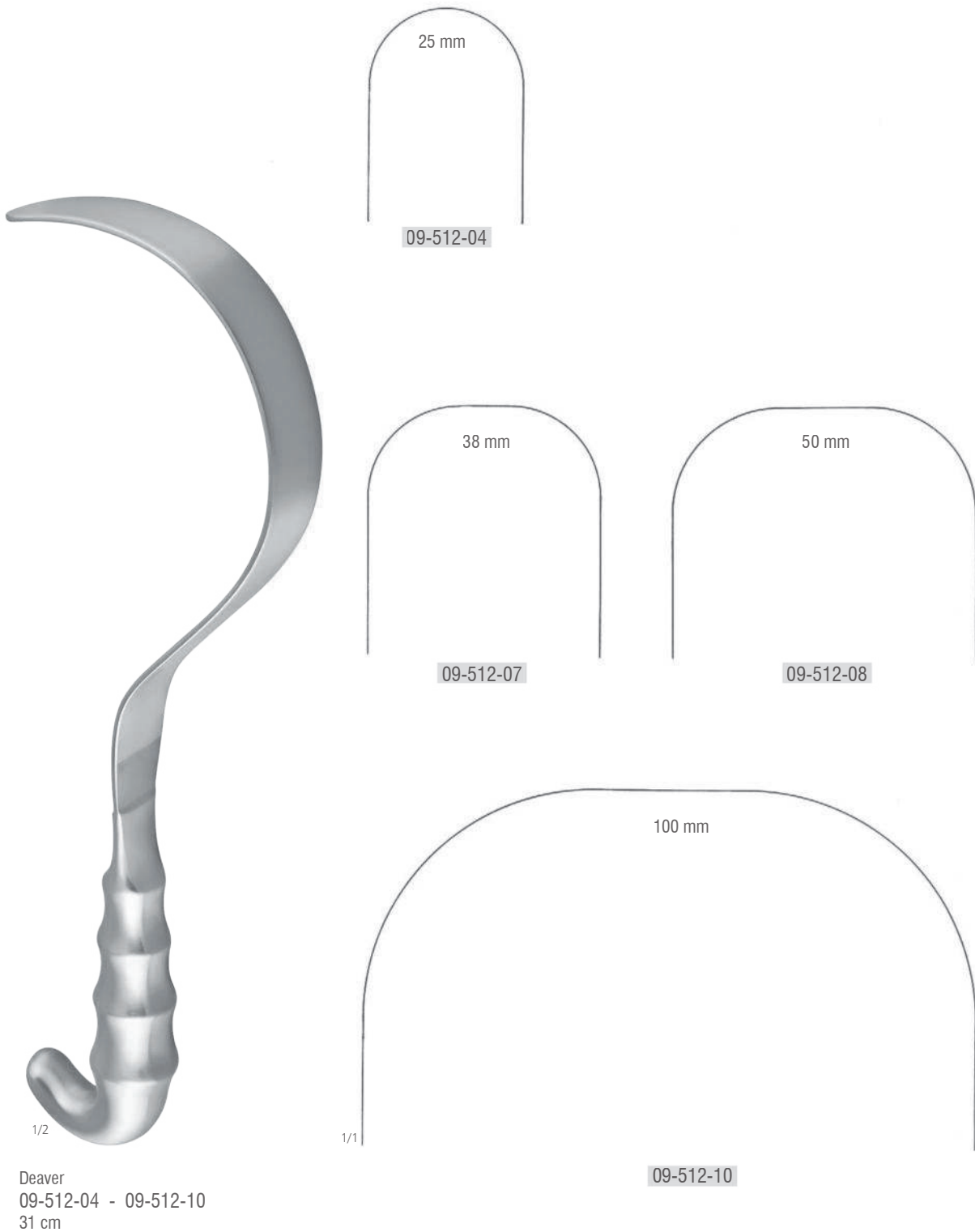

1/2  
Deaver  
09-512-04 - 09-512-10  
31 cm

09-512-10

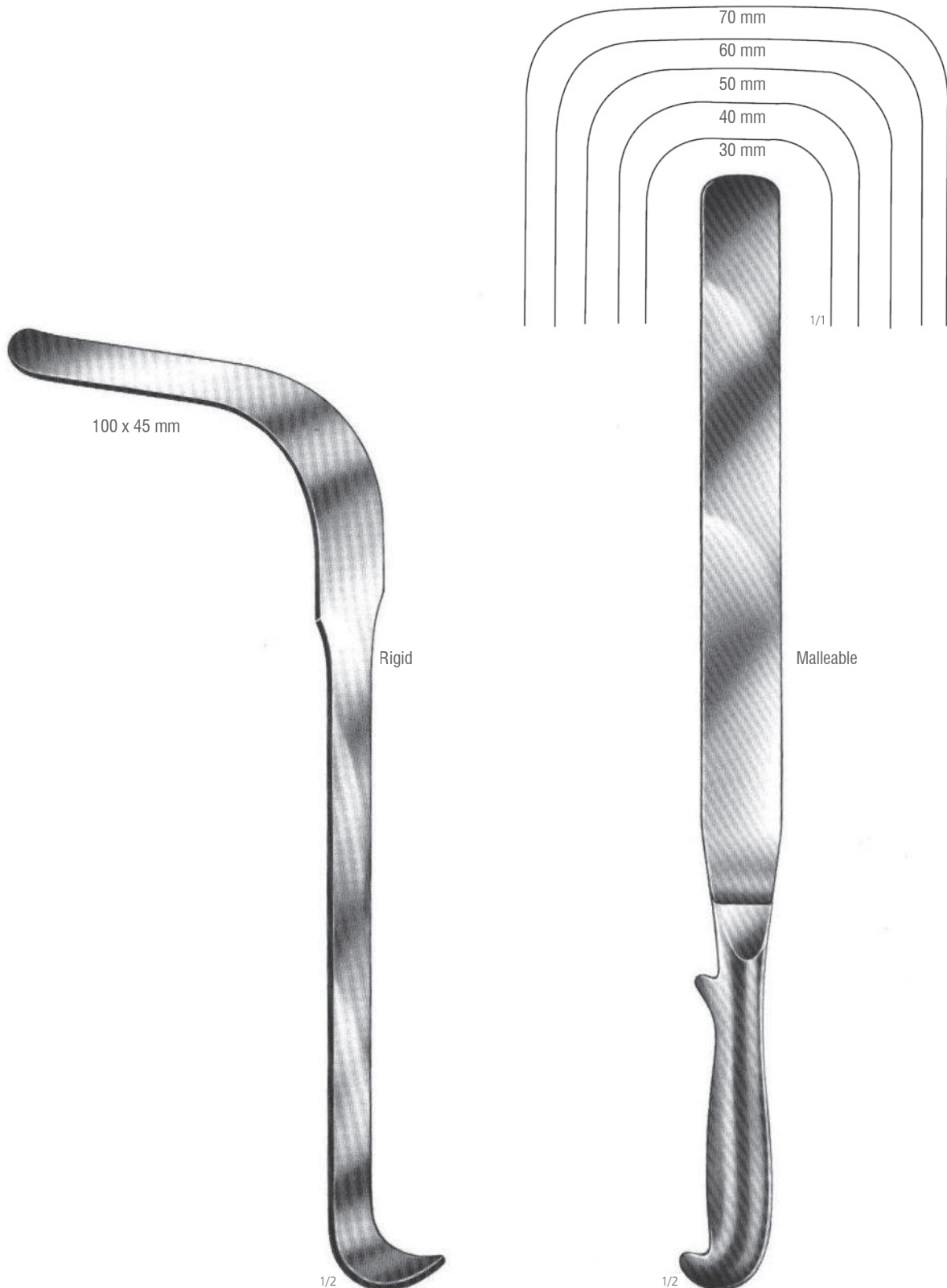

1/2  
Koerte  
09-514-28  
28 cm

1/2  
09-517-30 245 x 30 mm  
09-517-40 245 x 40 mm  
09-517-50 245 x 50 mm  
09-517-60 245 x 60 mm  
09-517-70 245 x 70 mm  
41 cm



Right

45 mm  
48 mm



Cooley  
09-523-01  
21.5 cm  
(Atrium)

Right, serrated

45 mm  
48 mm



Cooley  
09-523-02  
21.5 cm  
(Atrium)

Left

24 mm  
48 mm



Cooley  
09-523-03  
21.5 cm  
(Atrium)

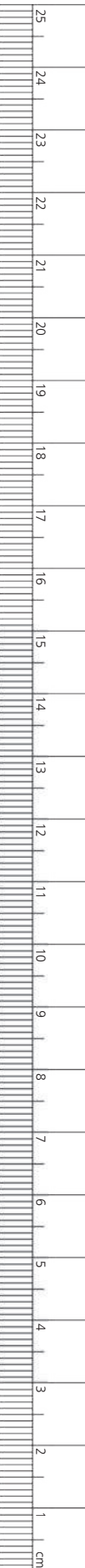



1/2

St. Marks  
09-527-01 - 09-527-03

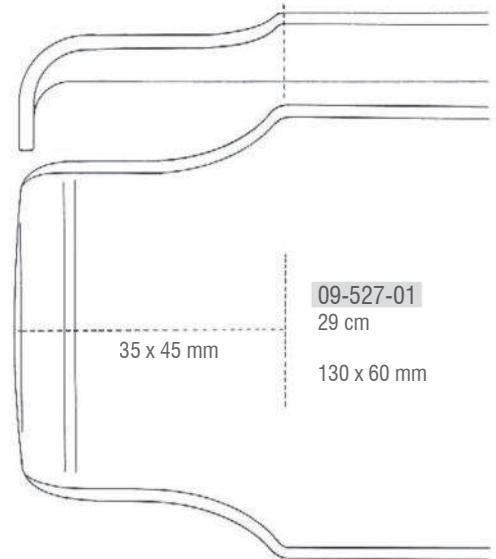

09-527-01  
29 cm  
130 x 60 mm

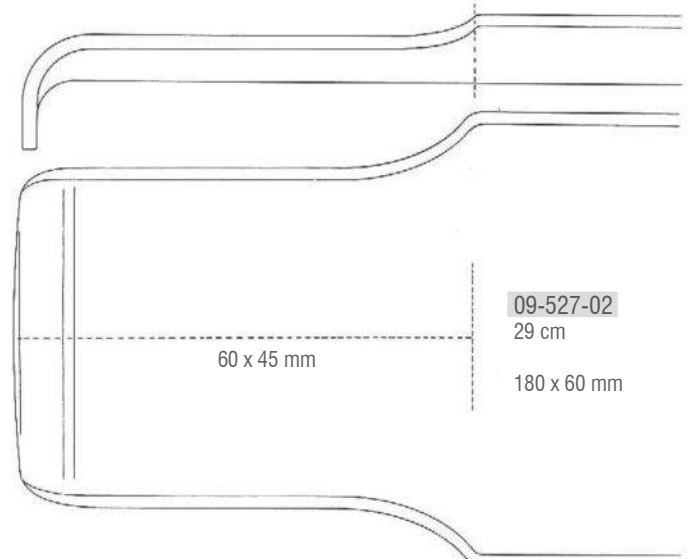

09-527-02  
29 cm  
180 x 60 mm

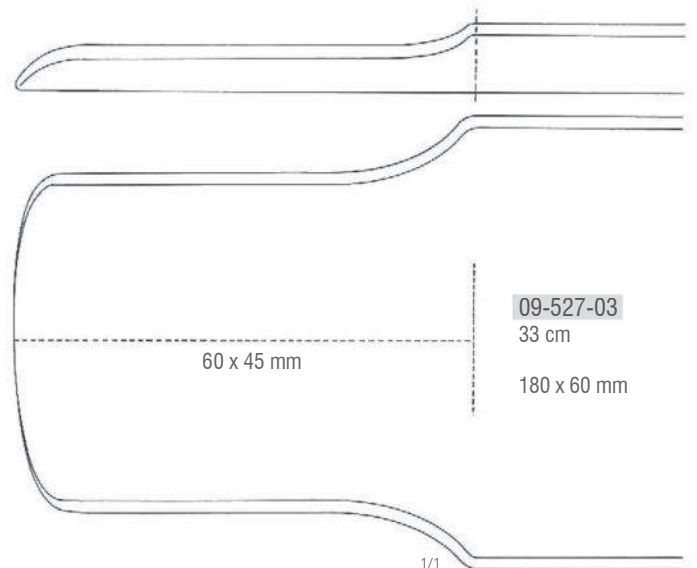

09-527-03  
33 cm  
180 x 60 mm

1/1

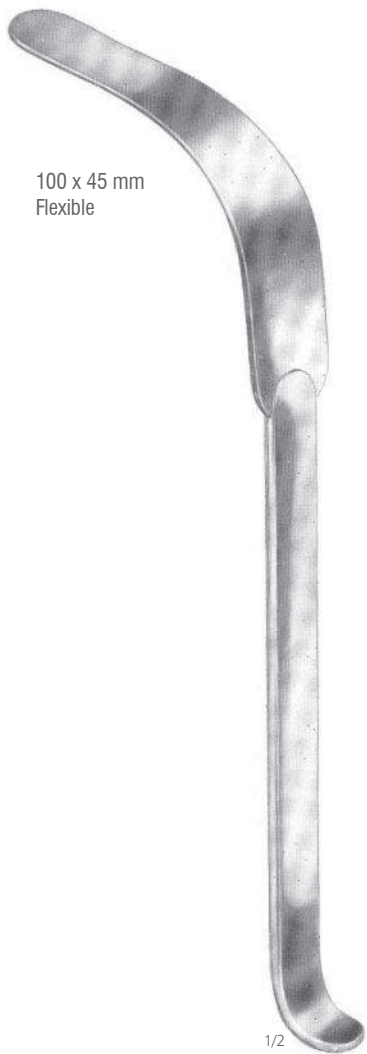

100 x 45 mm  
Flexible

1/2

Kuemmel  
09-531-28  
28 cm

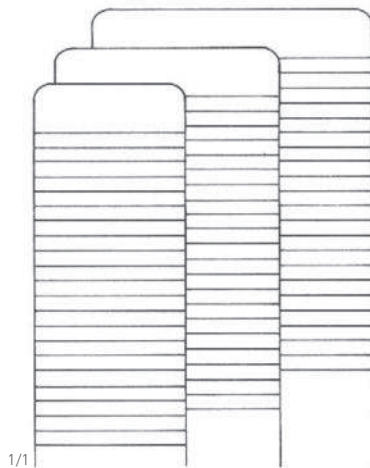

1/1



1/1

1/2

Kader  
09-533-20 20 mm  
09-533-30 30 mm  
09-533-40 40 mm  
27.5 cm

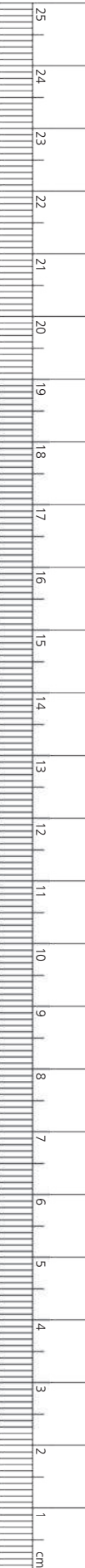

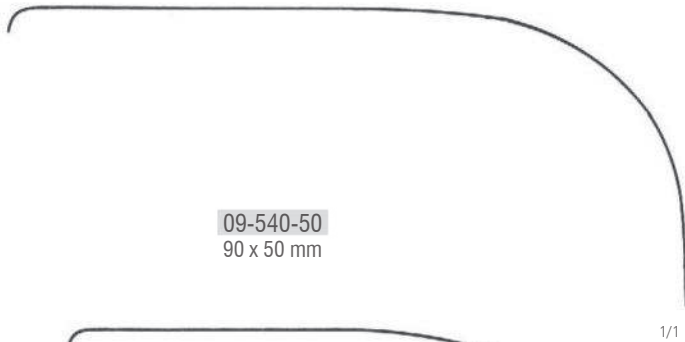

09-540-50  
90 x 50 mm

1/1

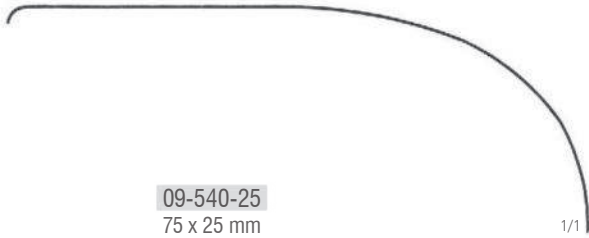

09-540-25  
75 x 25 mm

1/1

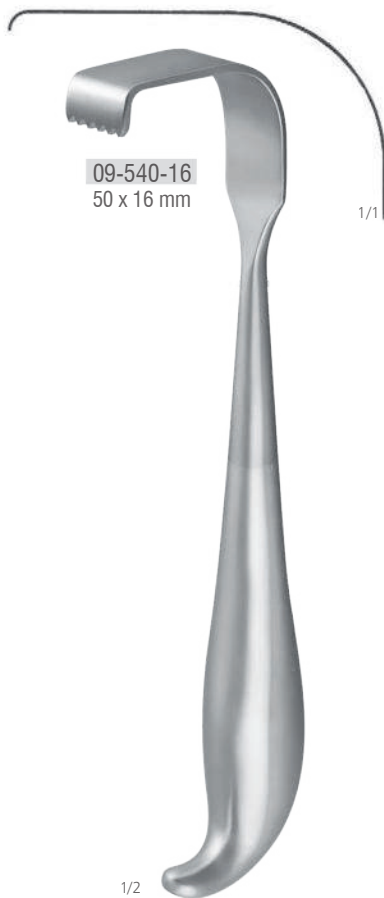

09-540-16  
50 x 16 mm

1/1

1/2

Meyerding  
09-540-16 - 09-540-50  
22.5 cm



1/2

Heaney  
09-544-01 45 x 25 mm  
09-544-02 45 x 28 mm  
09-544-03 45 x 28 mm  
27 cm

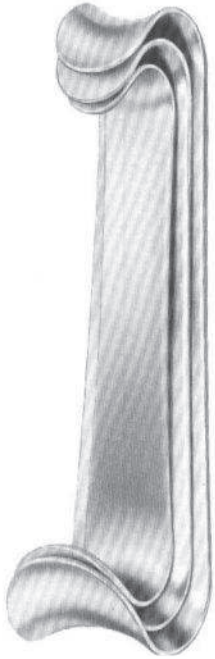
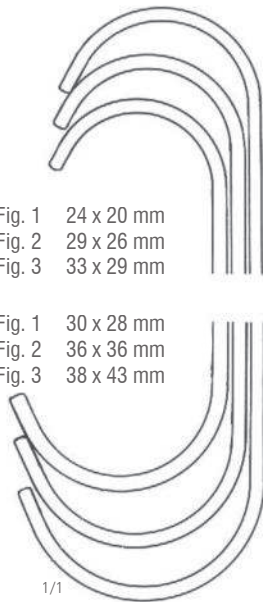

Fig. 1 24 x 20 mm  
Fig. 2 29 x 26 mm  
Fig. 3 33 x 29 mm

Fig. 1 30 x 28 mm  
Fig. 2 36 x 36 mm  
Fig. 3 38 x 43 mm



Roux

09-561-01	Fig.1	15 cm
09-561-02	Fig.2	16 cm
09-561-03	Fig.3	17 cm

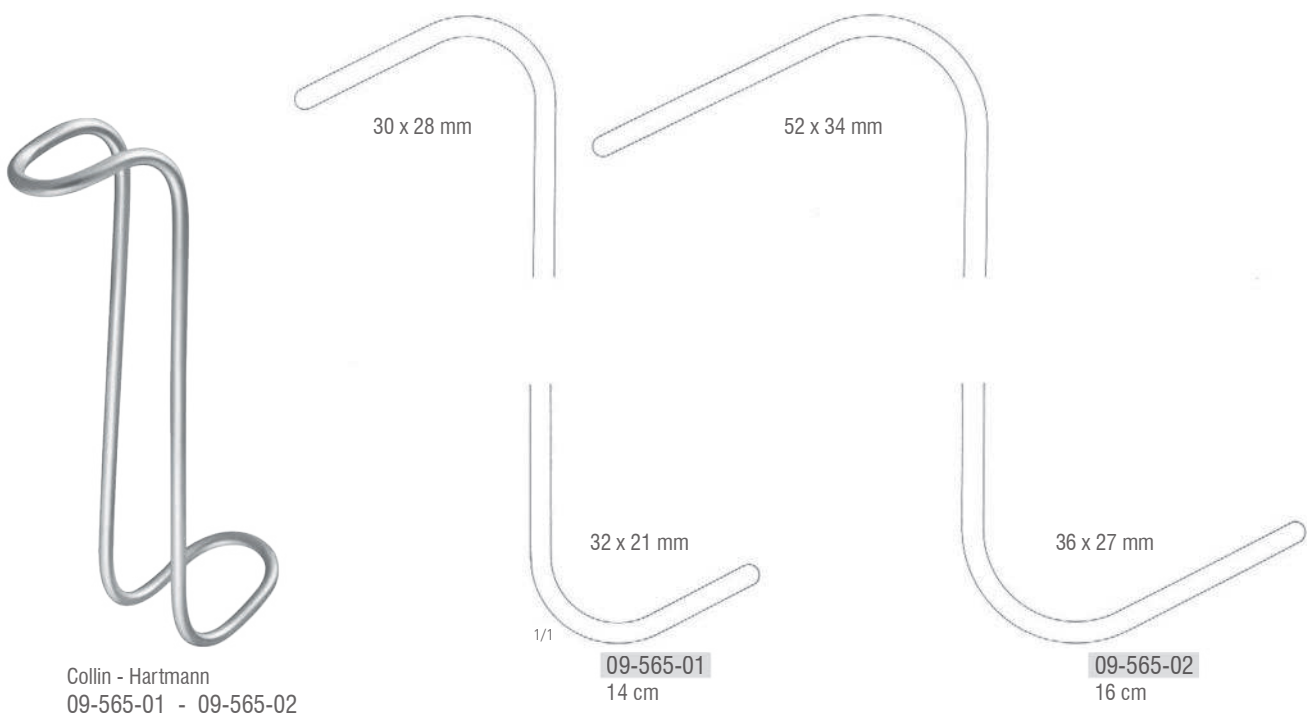

Collin - Hartmann  
09-565-01 - 09-565-02

09-565-01  
14 cm

09-565-02  
16 cm





Fig. 2 30 x 10 mm  
Fig. 1 26 x 10 mm

Fig. 1 30 x 13 mm  
Fig. 2 34 x 13 mm

Farabeuf  
09-573-00 Set  
12 cm

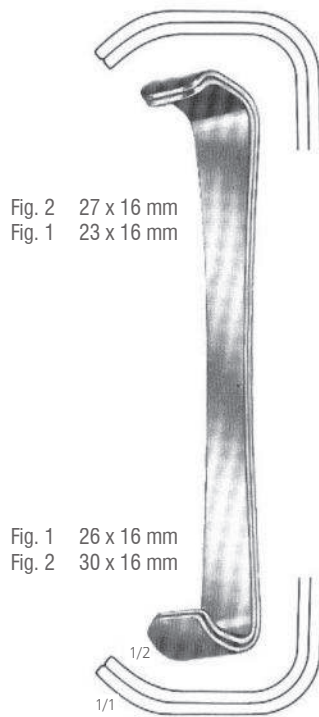

Fig. 2 27 x 16 mm  
Fig. 1 23 x 16 mm

Fig. 1 26 x 16 mm  
Fig. 2 30 x 16 mm

Farabeuf  
09-575-00 Set  
15 cm

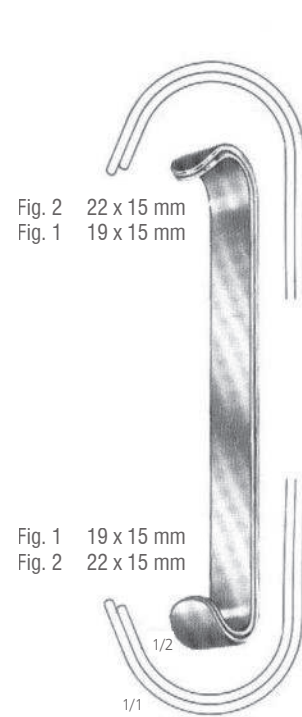

Fig. 2 22 x 15 mm  
Fig. 1 19 x 15 mm

Fig. 1 19 x 15 mm  
Fig. 2 22 x 15 mm

Parker  
09-577-01 Set  
13.5 cm



8 x 6 mm

Mini - Roux  
09-579-06  
14 cm



Baby - Roux  
09-583-13  
13 cm



Parker  
09-585-02 Set  
18 cm

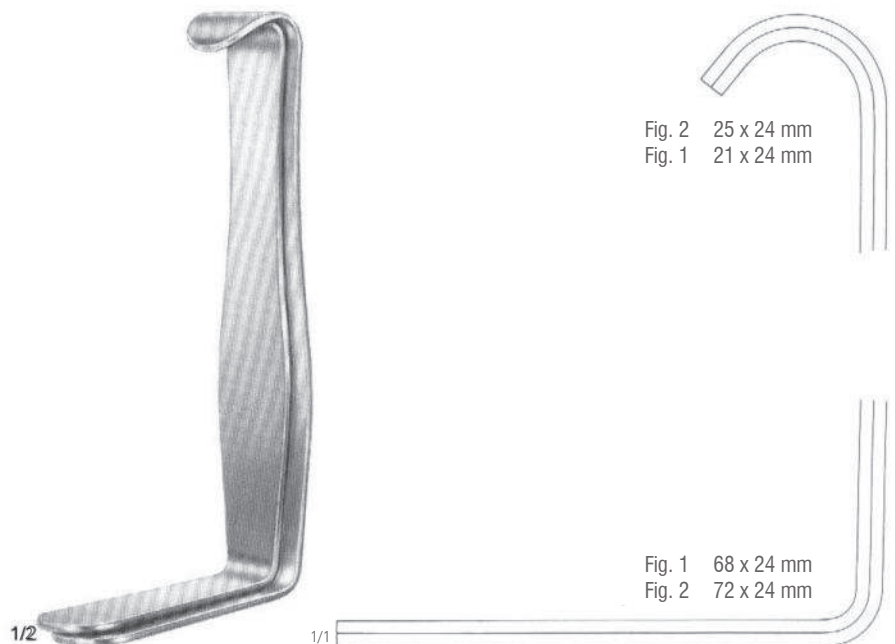

Parker - Mott  
09-587-00 Set  
16 cm



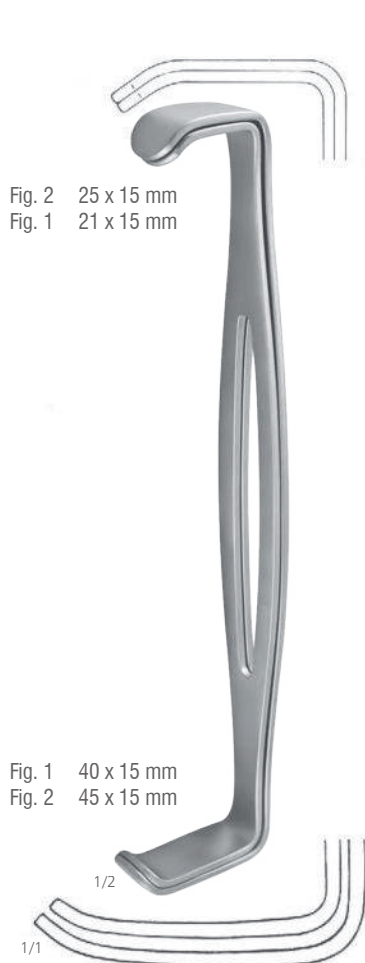

Parker - Langenbeck  
09-593-00 Set  
21 cm



Goelet  
09-595-19  
19 cm



Mathieu  
09-597-00 Set  
20 cm





1/2  
Finsen  
09-600-05 - 09-603-07  
5 cm  
3 x 3 Teeth



1/1  
09-600-05  
Sharp

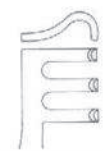

09-601-05  
Blunt

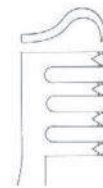

09-602-07  
Sharp

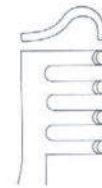

09-603-07  
Blunt



1/2  
Finsen Mod. Martin  
09-604-07 - 09-605-07  
7 cm  
3 x 4 Teeth

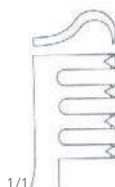

1/1  
09-604-07  
Sharp

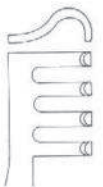

09-605-07  
Blunt



1/1  
Sharp

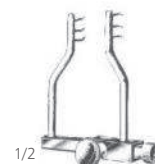

1/2  
Logan  
09-608-04  
4 cm  
3 x 3 Teeth

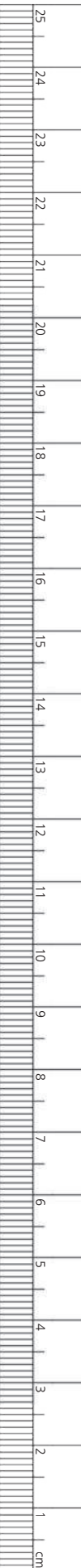



Alm

09-612-07	7 cm	Sharp	II
09-612-10	10 cm	Sharp	II
09-613-07	7 cm	Blunt	II
09-613-10	10 cm	Blunt	II

4 x 4 Teeth

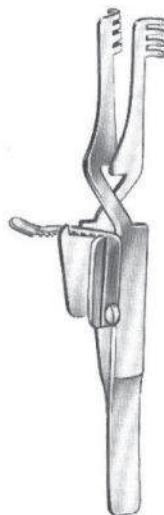

09-614-10	Sharp	II
09-615-10	Blunt	II

10 cm  
4 x 4 Teeth



Allport

09-618-10	Sharp	II
09-619-10	Blunt	II

10 cm  
4 x 4 Teeth

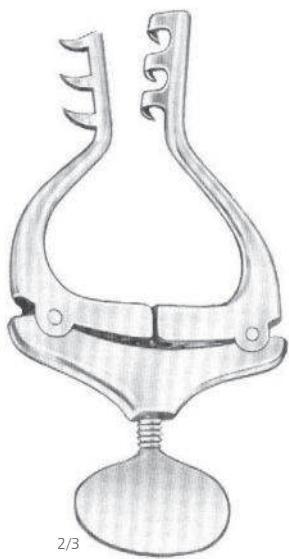
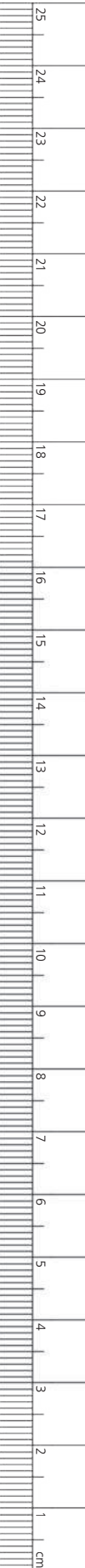

2/3

Jansen

09-630-10 Sharp 

09-631-10 Blunt 

10 cm

3 x 3 Teeth



2/3

Jansen

09-632-10 Sharp 

09-633-10 Blunt 

10 cm

3 x 3 Teeth



2/3

Snitman

09-634-10 Sharp 

09-635-10 Blunt 

10 cm

3 x 3 Teeth



1/2

Scalp Contour  
09-638-14 - 09-639-14  
14 cm  
3 x 4 Teeth

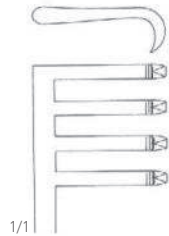

1/1

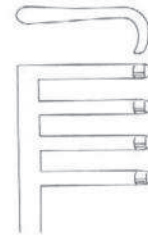

09-638-14   
Sharp



09-639-14   
Blunt



1/2

Anderson - Adson  
09-642-19 Sharp   
09-643-19 Blunt   
19.5 cm  
4 x 4 Teeth

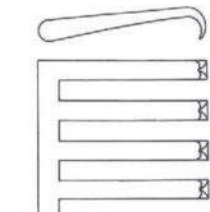

1/1

09-642-19   
Sharp



1/2

Weitlaner  
09-646-20 - 09-647-20  
20 cm  
3 x 4 Teeth

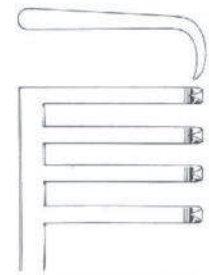

09-646-20   
Sharp

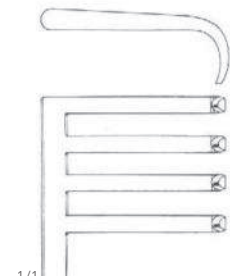

1/1

09-647-20   
Blunt

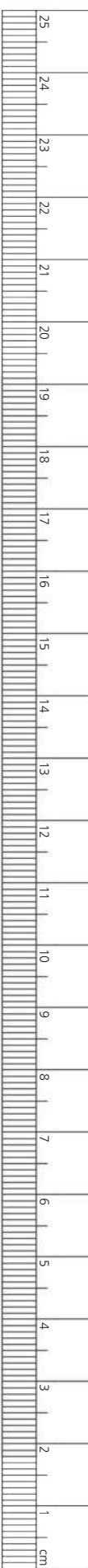

Adson  
09-650-26 - 09-653-26  
26.5 cm

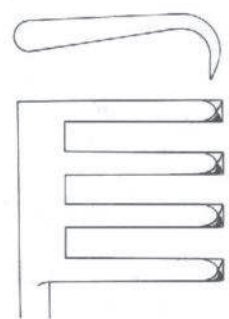

09-650-26   
Sharp  
3 x 4 Teeth

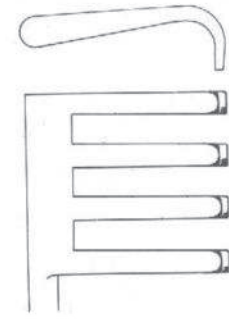

09-651-26   
Blunt  
3 x 4 Teeth

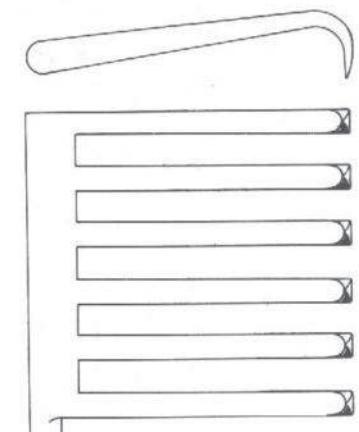

09-652-26   
Sharp  
6 x 6 Teeth

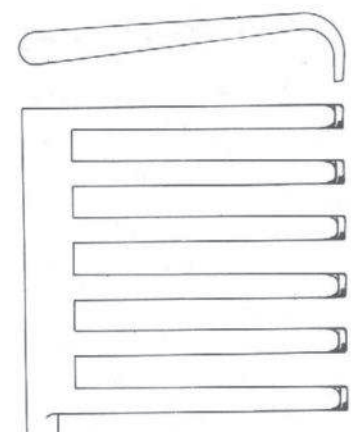

09-653-26   
Blunt  
6 x 6 Teeth

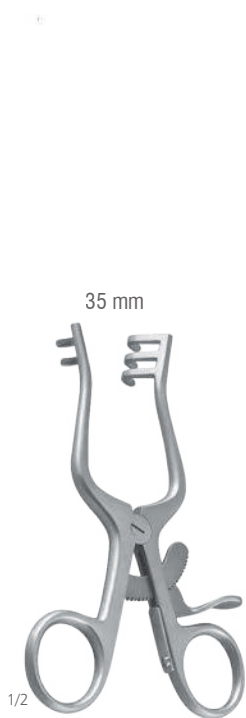

Weitlaner - Loktite  
09-660-10 - 09-661-10  
10.5 cm

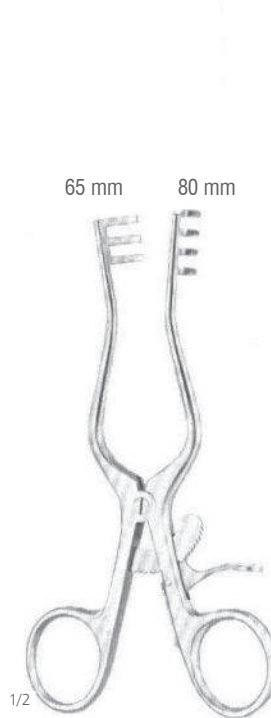

Weitlaner  
09-662-13 - 09-663-16

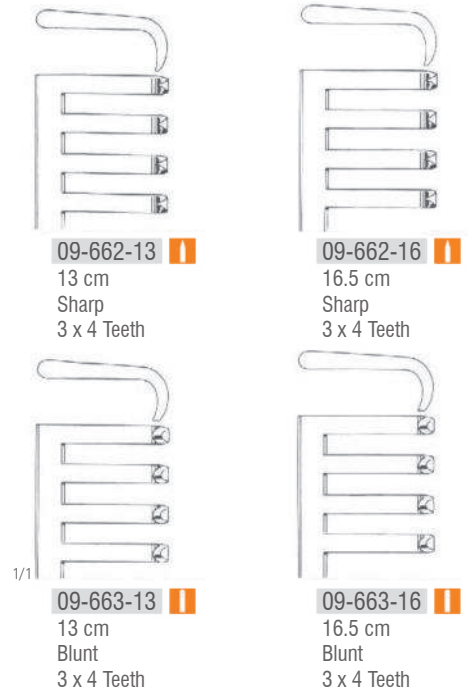

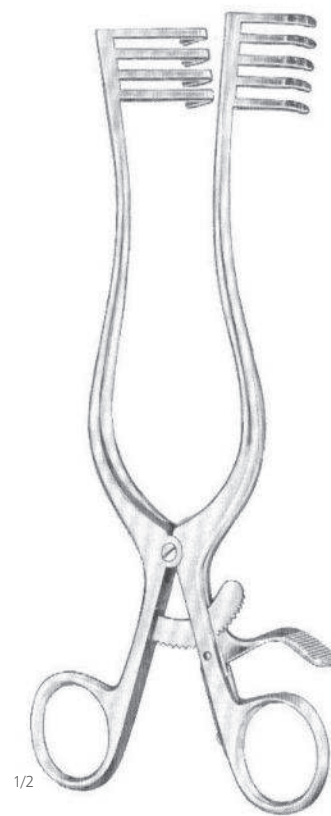

Weitlaner - Wullstein  
09-664-13 - 09-665-13  
13 cm





Travers  
09-668-21 Blunt  
21 cm  
4 x 5 Teeth





Plester  
09-670-13 Sharp   
09-671-13 Blunt   
13 cm  
2 x 2 Teeth



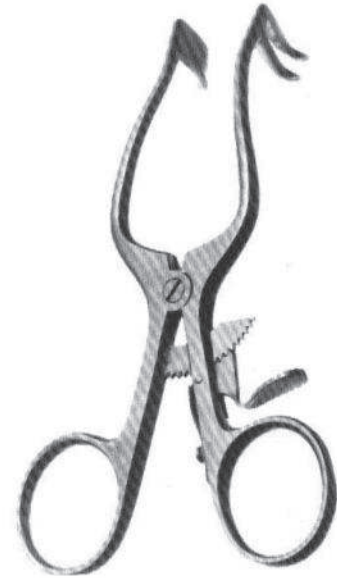

Plester - R  
09-672-10 Sharp   
09-673-10 Blunt   
10 cm  
2 Teeth

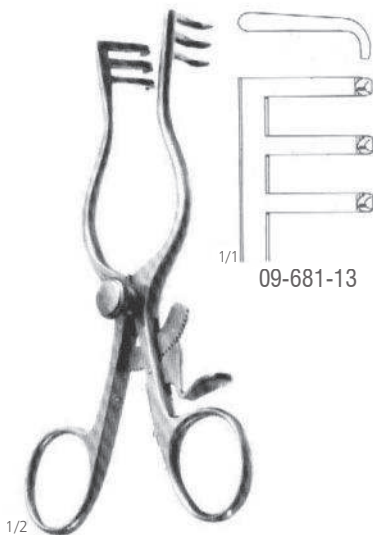

Plester - L  
09-674-10 Sharp   
09-675-10 Blunt   
10 cm  
2 Teeth



Milligan  
09-680-13 Sharp   
09-681-13 Blunt   
13 cm  
3 x 3 Teeth







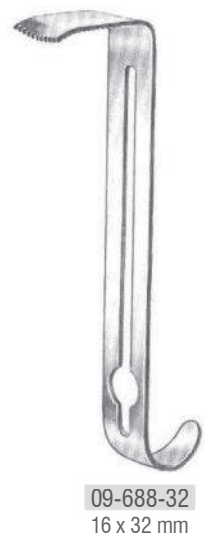
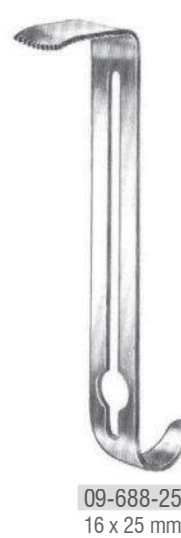
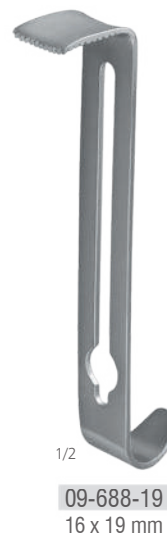
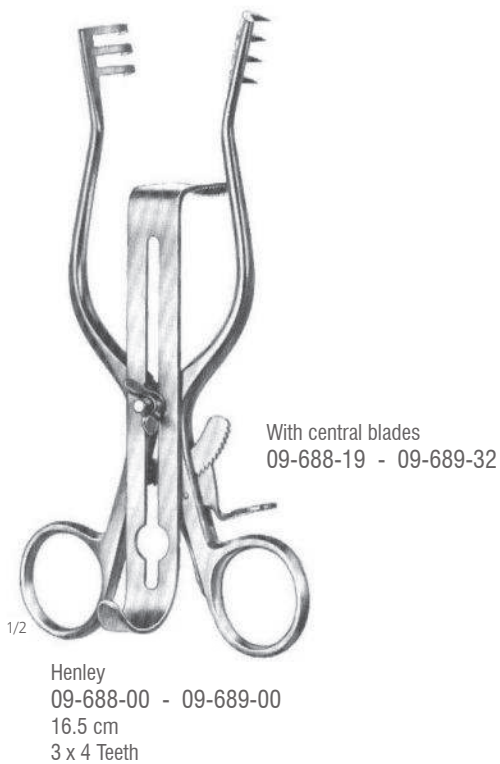
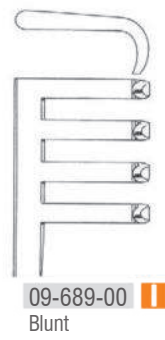

Weitlaner - Baby  
09-687-13  
13 cm









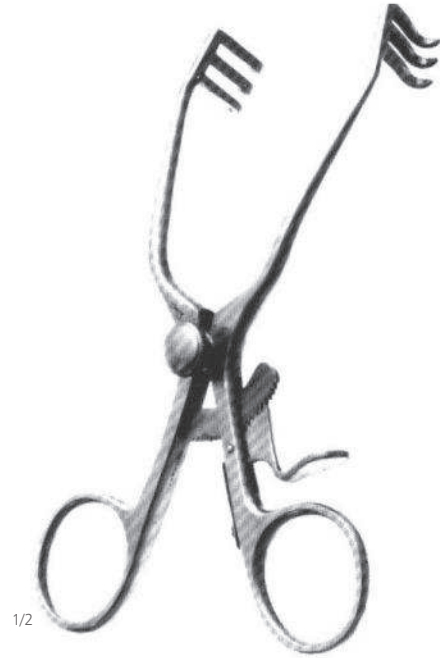

Wullstein  
09-690-10 10.5 cm Sharp   
09-690-13 13.0 cm Sharp   
09-690-16 16.0 cm Sharp   
09-691-10 10.5 cm Blunt   
09-691-13 13.0 cm Blunt   
09-691-16 16.0 cm Blunt   
3 x 3 Teeth



Schuhknecht  
09-692-10 Sharp   
09-693-16 Blunt   
14 cm  
3 x 3 Teeth



Mollison  
09-694-15 Sharp   
09-695-15 Blunt   
15 cm  
4 x 4 Teeth

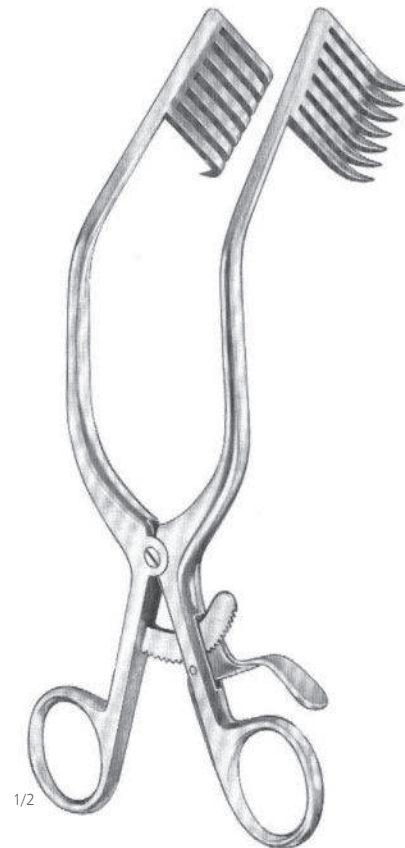

Mollison  
09-696-22 Sharp   
09-697-22 Blunt   
22 cm  
7 x 7 Teeth

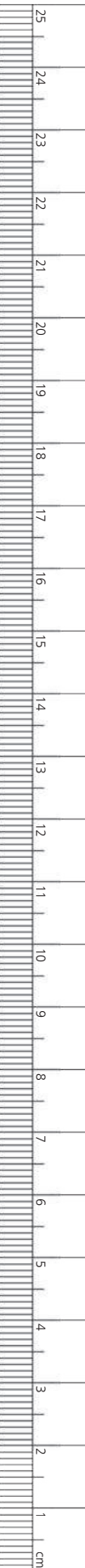

Sharp



Adson  
09-700-27   
27 cm  
6 x 6 Teeth

Sharp

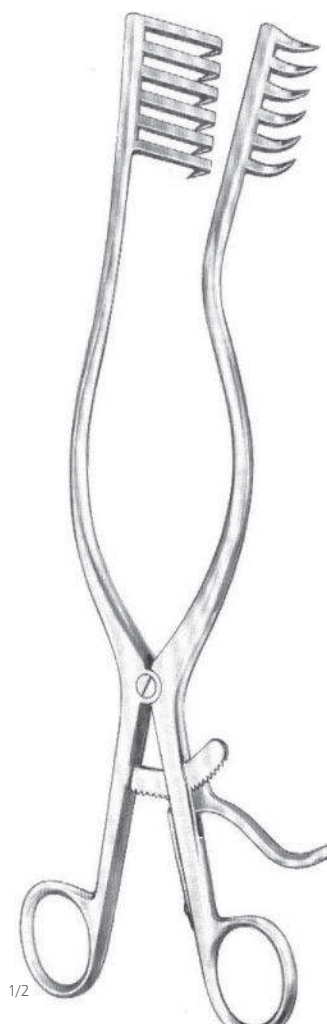

Adson - R  
09-701-01   
27 cm  
6 x 6 Teeth

Sharp

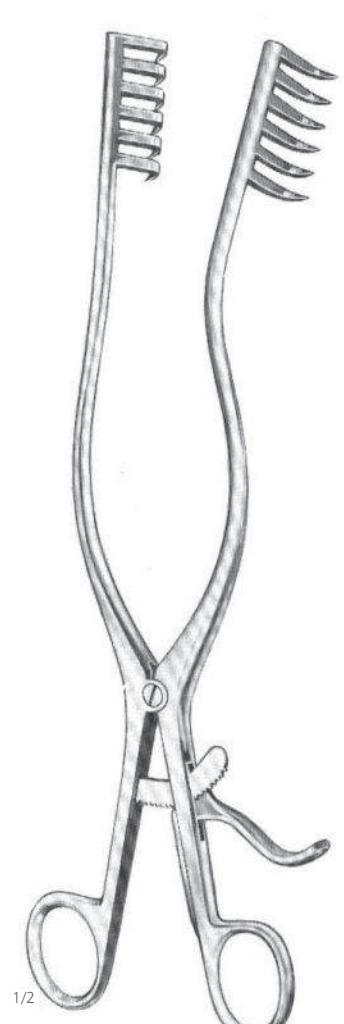

Adson - L  
09-701-02   
27 cm  
6 x 6 Teeth

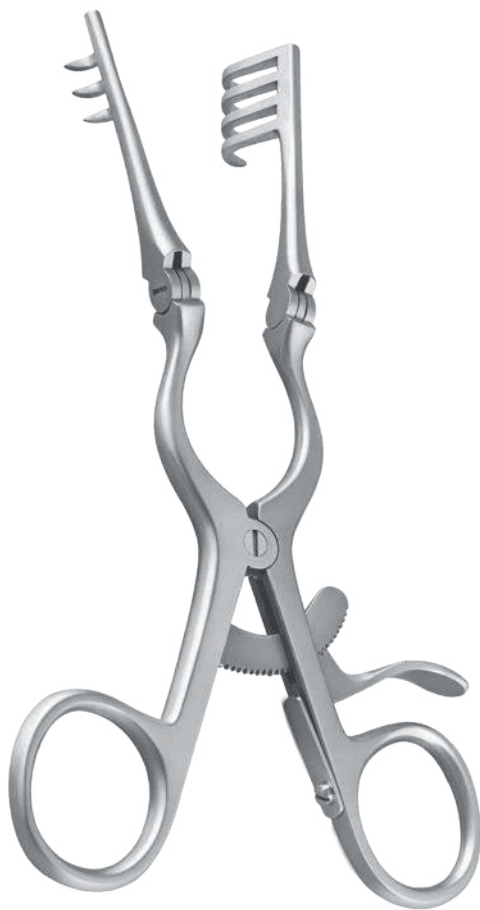

Adson  
09-704-13 - 09-705-26  
3 x 4 Teeth

Sharp

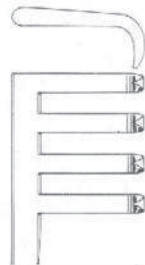

09-704-13 ■  
13 cm

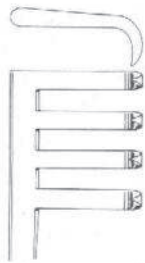

09-704-16 ■  
16 cm

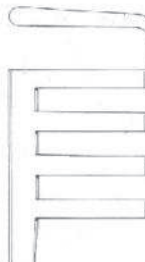

09-704-20 ■  
20 cm

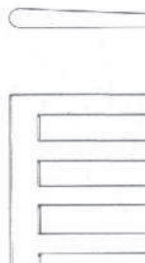

1/1  
09-704-26 ■  
26 cm

Blunt



09-705-13 ■  
13 cm

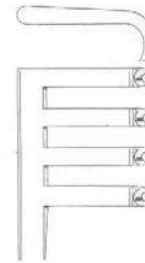

09-705-16 ■  
16 cm

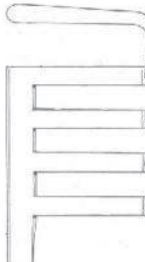

09-705-20 ■  
20 cm

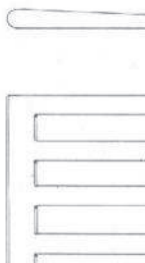

09-705-26 ■  
26 cm



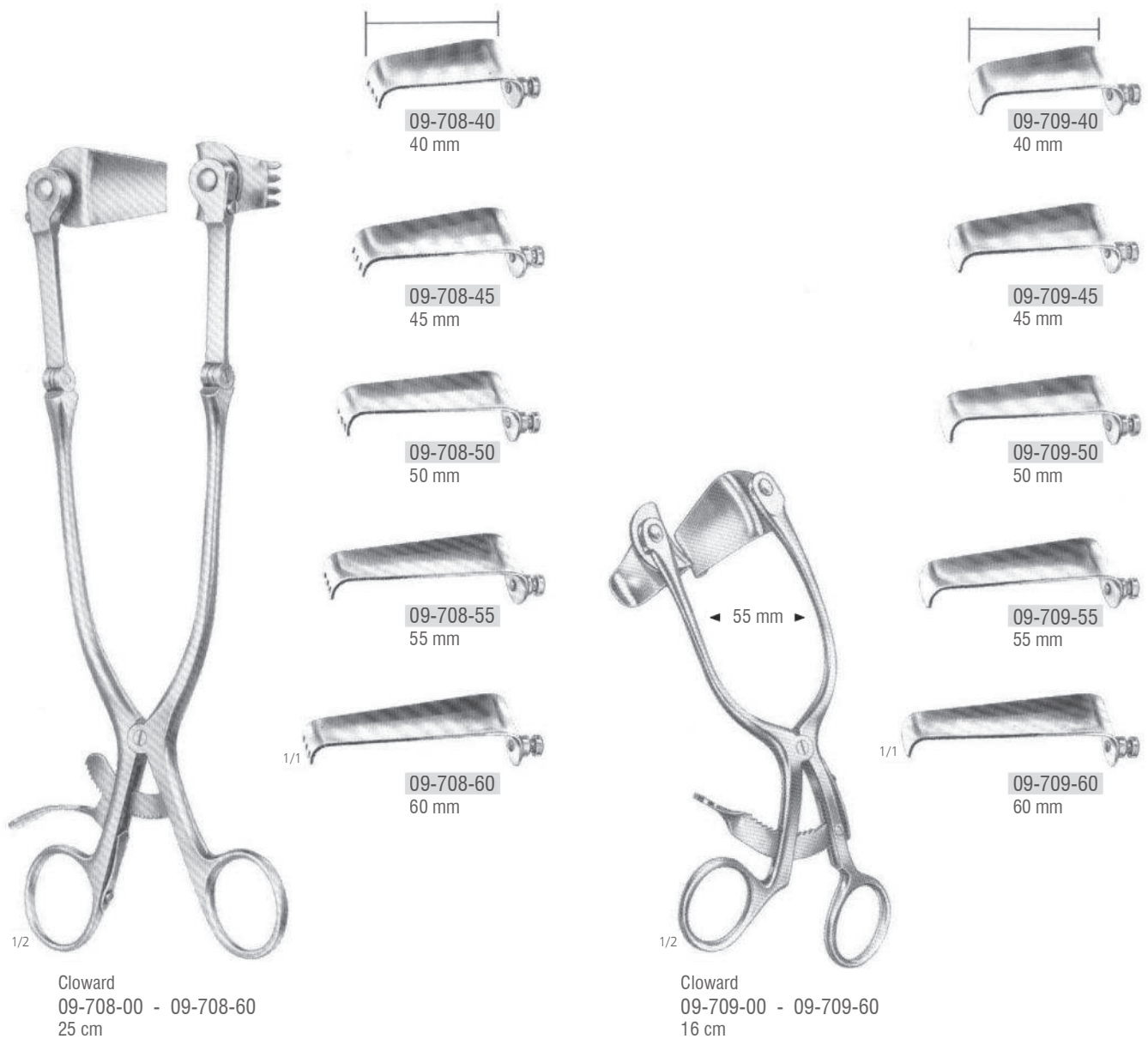

- 09-708-00 Retractor complete (with 2 blades ea.)
- 09-708-25 Retractor only
- 09-709-00 Retractor complete (with 2 blades ea.)
- 09-709-25 Retractor onlt



Cone

09-712-13	13.0 cm	Sharp	
09-712-16	16.5 cm	Sharp	
09-712-20	20.0 cm	Sharp	
09-712-25	25.0 cm	Sharp	
09-713-13	13.0 cm	Blunt	
09-713-16	16.5 cm	Blunt	
09-713-20	20.0 cm	Blunt	
09-713-25	25.0 cm	Blunt	

3 x 4 Teeth

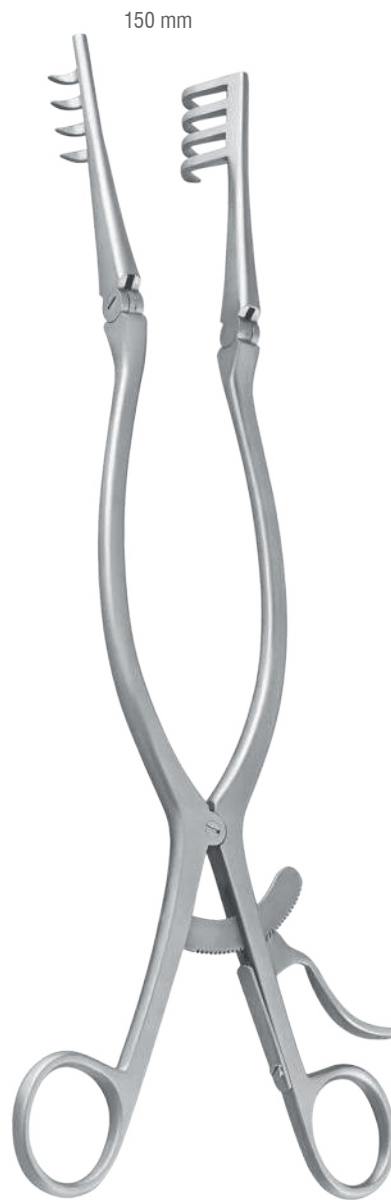

09-714-31	Sharp		09-714-33	Sharp	
09-715-31	Blunt		09-715-33	Blunt	
31 cm			33 cm		
4 x 4 Teeth			4 x 5 Teeth		



09-716-32	Sharp	
09-717-32	Blunt	
32 cm		
4 x 5 Teeth		



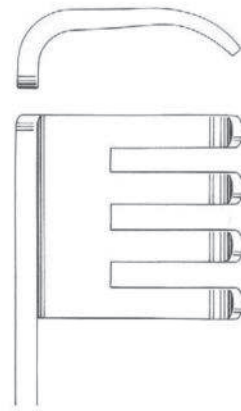

09-721-01

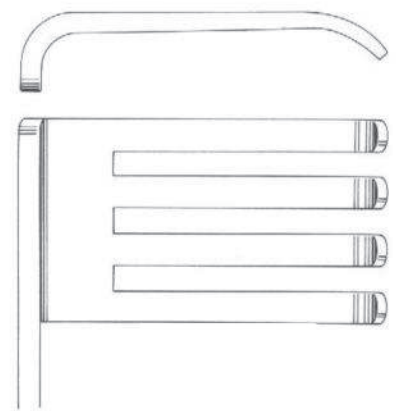

09-721-04

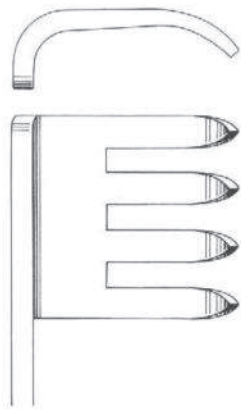

09-720-01

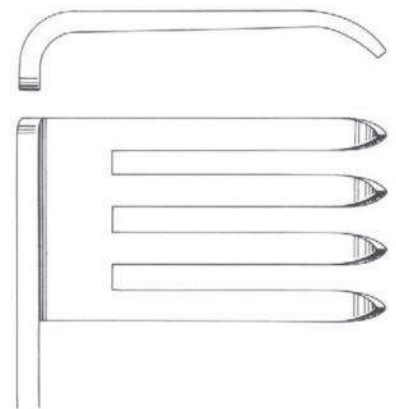

09-720-04

Beckmann - Adson



09-720-01	25 x 25 mm	Sharp	II
09-720-02	25 x 31 mm	Sharp	II
09-720-03	25 x 40 mm	Sharp	II
09-720-04	25 x 45 mm	Sharp	II
09-721-01	25 x 25 mm	Blunt	II
09-721-02	25 x 31 mm	Blunt	II
09-721-03	25 x 40 mm	Blunt	II
09-721-04	25 x 45 mm	Blunt	II

31 cm

4 x 4 Teeth



1/2

Beckmann - Eaton  
 09-724-32 Sharp   
 09-725-32 Blunt   
 32 cm  
 7 x 7 Teeth

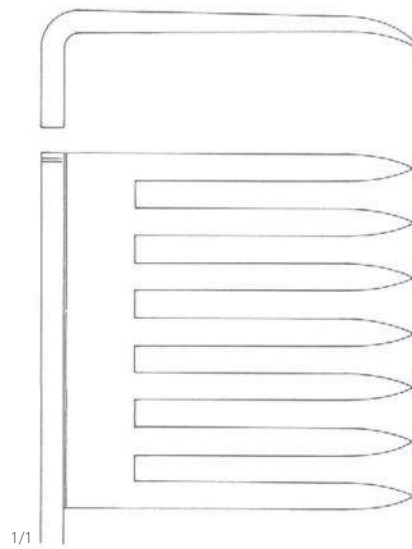

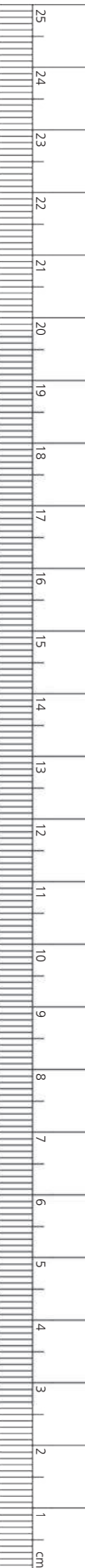

09-724-32





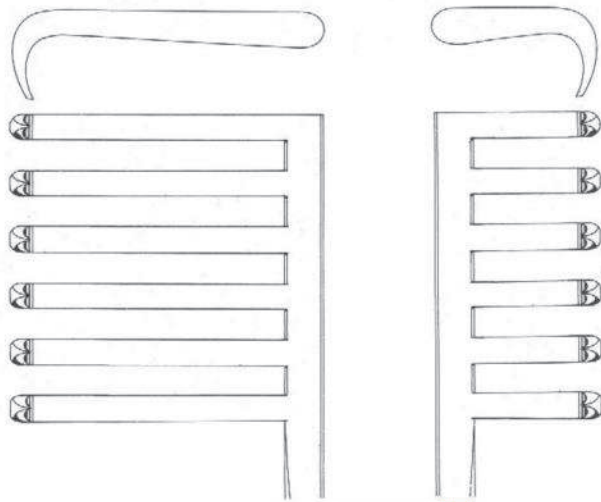

Martin  
09-728-01 - 09-728-02  
27 cm  
6 x 6 Teeth

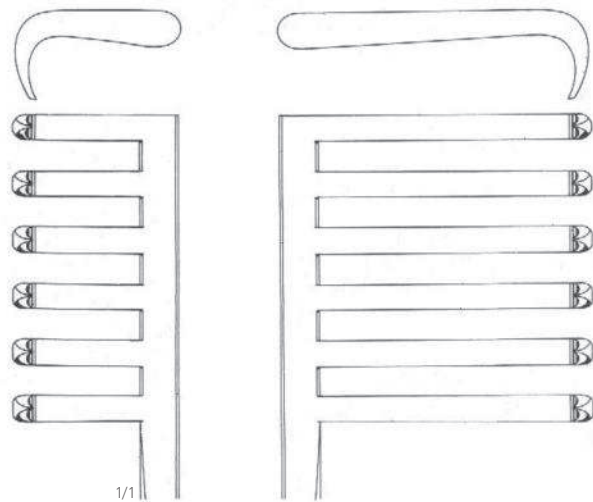

09-728-01   
Sharp



1/1  
09-728-02   
Sharp



LOW PROFILE Universal hand and carpal tunnel retractor

- Low profile retractors will automatically expand to accommodate enlargement of wound.
- Ring handles do not obstruct and will not slip during application.
- This universal pattern has long blunt hooks, so it will not fall out of wound.

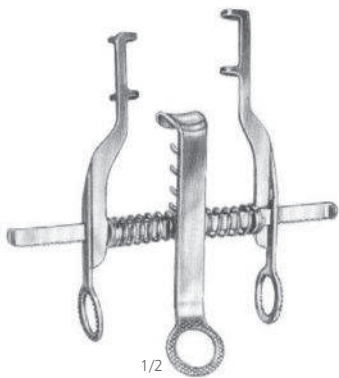

Vickers Low - Profile  
**09-730-00**  
7.5 cm  
Complete with center blade, 10 x 18 mm

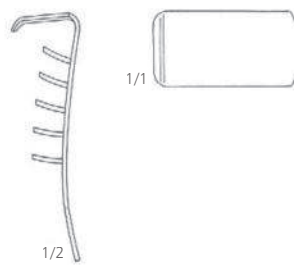

**09-730-01**  
Center blade only, 10 x 18 mm

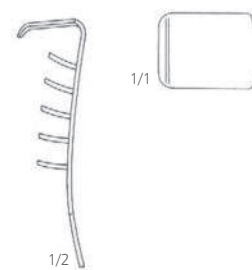

**09-730-02**  
Center blade only, 10 x 12 mm



LOW PROFILE Deep hand and forearm retractor

- Low profile retractors will automatically expand to accommodate enlargement of wound.
- Ring handles do not obstruct and will not slip during application.
- This universal pattern has long blunt hooks, so it will not fall out of wound.

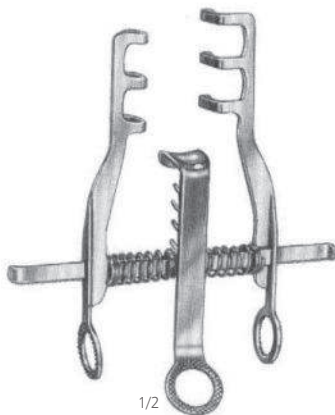

Vickers Low - Profile  
09-731-00  
9 cm  
Complete with center blade, 10 x 18 mm

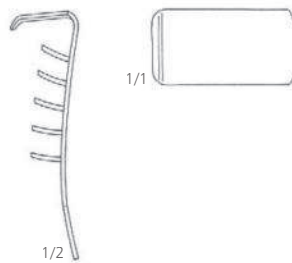

09-731-01  
Center blade only, 10 x 18 mm

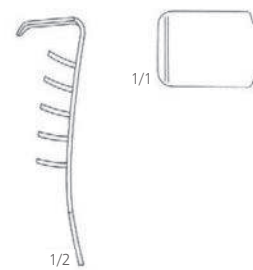

09-731-02  
Center blade only, 10 x 12 mm

LOW PROFILE Trigger Finger and small wound retractor

- Low profile retractors will automatically expand to accommodate enlargement of wound.
- Ring handles do not obstruct and retractor will not fall out of wound.
- Holds fat tissue away from tendon sheath.

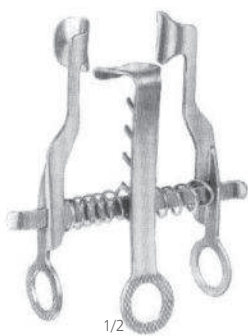

Vickers Low - Profile  
**09-732-00**  
7.5 cm  
Complete with center blade, 10 x 18 mm

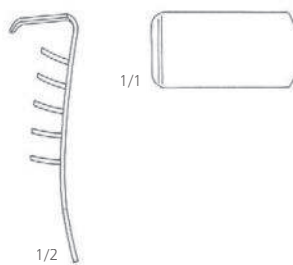

**09-732-01**  
Center blade only, 10 x 18 mm

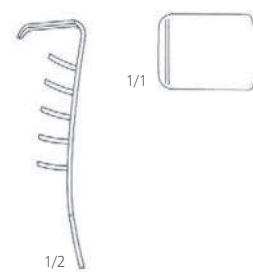

**09-732-02**  
Center blade only, 10 x 12 mm

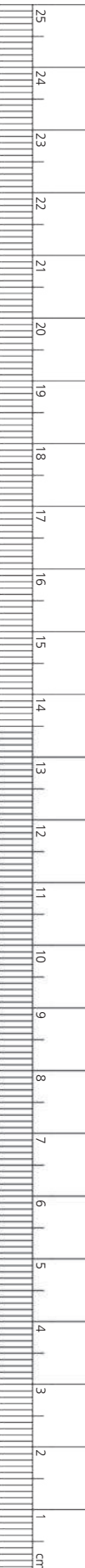

#### Thumb and Finger Retractor

- This pattern can be used in any situation having a wound on the front, back or side of the finger or thumb.
- These finger retractors will automatically expand to accommodate enlargement of wound.
- Retractor embraces the finger, cannot fall away.
- Long blunt hooks for thin skin.



1/2

Vickers

09-736-01

5 cm



Gelpi  
09-740-09 9 cm  
09-740-11 11 cm  
09-740-14 14 cm  
09-740-19 19 cm



Gelpi - Loktite  
09-742-13  
13 cm

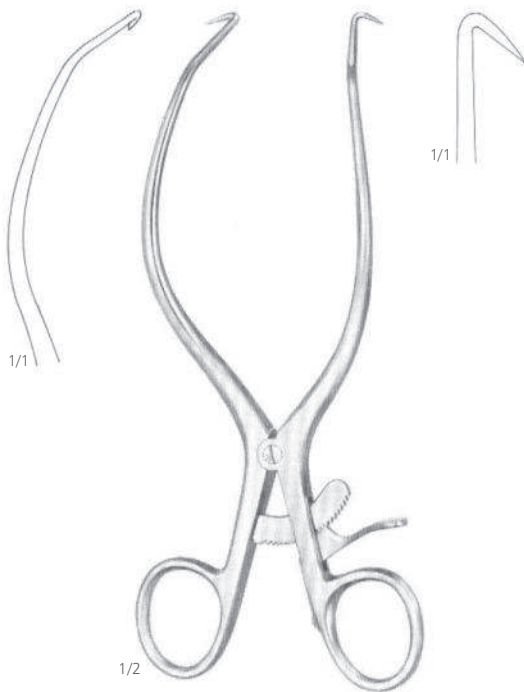

Gelpi - Loktite  
09-742-18  
18 cm

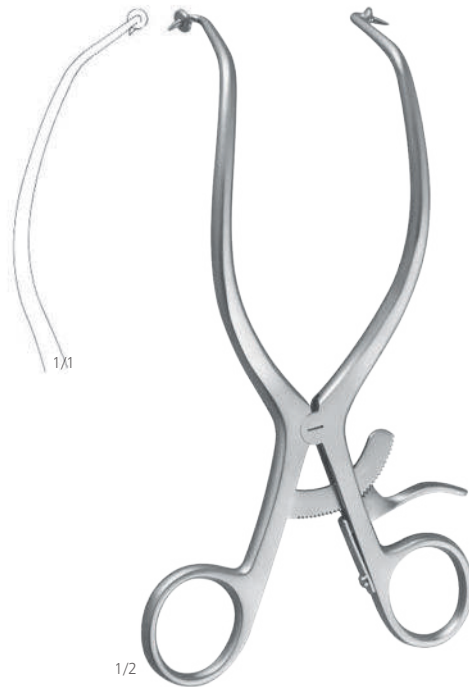

Gelpi - Loktite  
09-744-18  
18 cm





1/2

Joll (Friedman)  
09-746-00  
15.5 cm



1/2

Meyetding  
09-750-01 32 x 25 mm  
09-750-02 54 x 25 mm  
09-750-03 60 x 19 mm  
09-750-04 60 x 25 mm  
20 cm

32 x 25 mm



1/2

Markham - Meyetding  
09-752-01  
18 cm

32 x 25 mm



1/2

Markham - Meyetding  
09-752-02  
18 cm



Rightby  
09-756-01 35 x 20 mm  
09-756-02 60 x 20 mm  
09-756-03 65 x 15 mm  
18 cm



Darling  
09-758-01  
18 cm

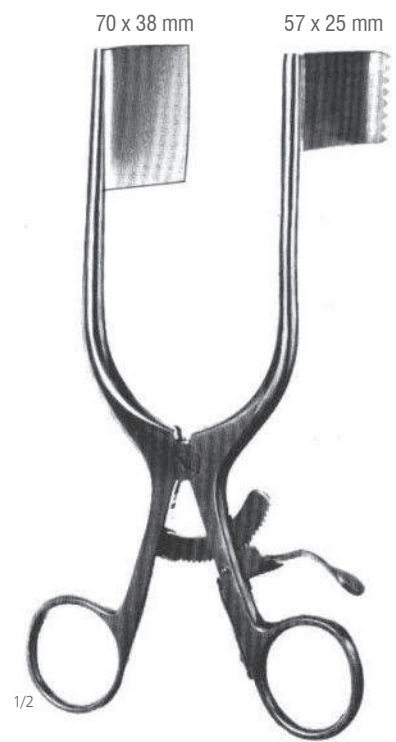

Darling  
09-758-02  
18 cm



Tubinger Modell  
09-760-16 16.5 cm  
09-760-18 18.0 cm



Richter  
09-762-16  
16.5 cm



Mayo - Adams  
09-764-17  
17 cm

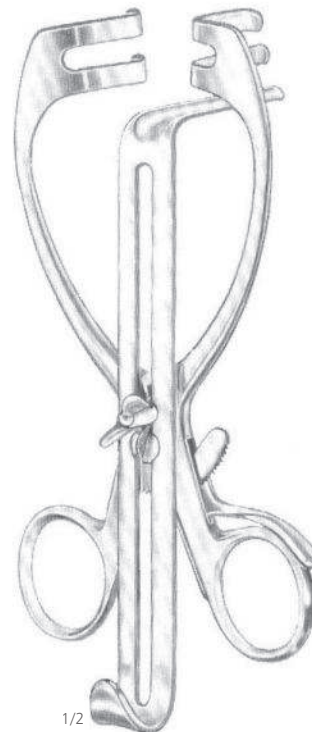

Mayo - Adams  
09-766-17  
17 cm





Walton  
09-768-01  
18 cm



Walton  
09-768-02  
18 cm



Knighthon  
09-770-01  
18 cm



Knighthon  
09-770-02  
18 cm

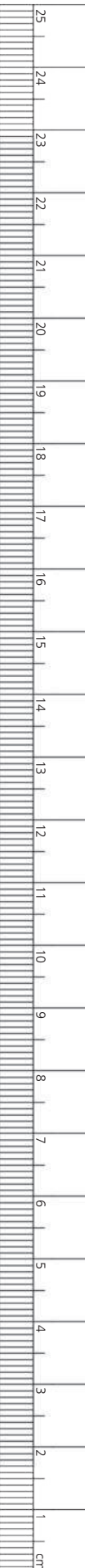

TRIMED Exchangeable Blades  
Measurement of blades: Depth x Width

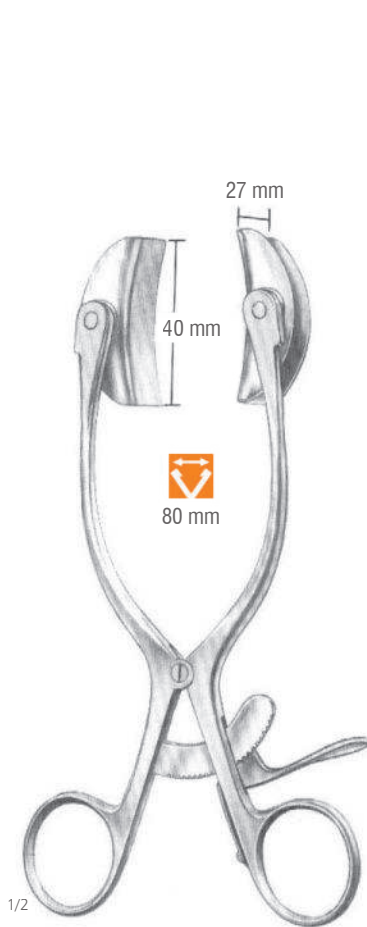

Baby - Collin  
09-780-00

Complete, with 2 pairs of blades



Collin  
09-782-22

Complete, with 1 pair of blades  
38 x 60 mm

TRIMED Exchangeable Blades  
Measurement of blades: Depth x Width



Collin

	S	M
09-783-00	38 x 60 mm	38 x 55 mm
09-784-00	38 x 60 mm	55 x 55 mm
09-785-00	38 x 80 mm	55 x 65 mm
09-786-00	38 x 80 mm	50 x 75 mm
09-787-00	38 x 100 mm	55 x 75 mm

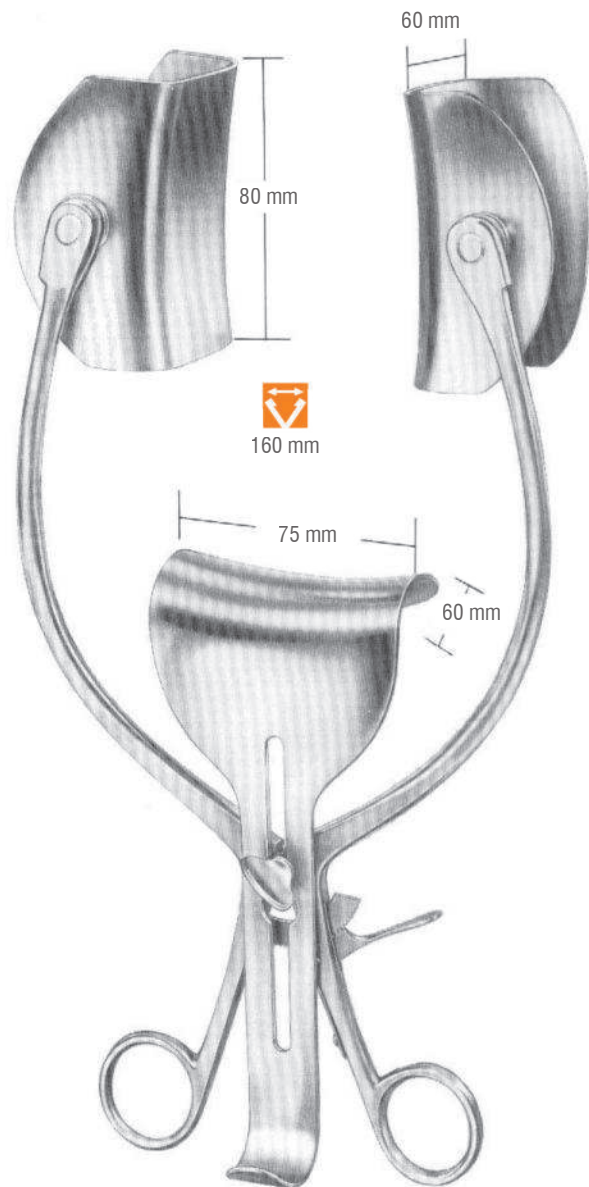

Collin - Loktite

09-789-00  
26 cm

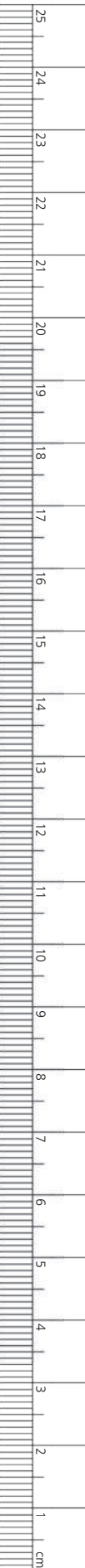

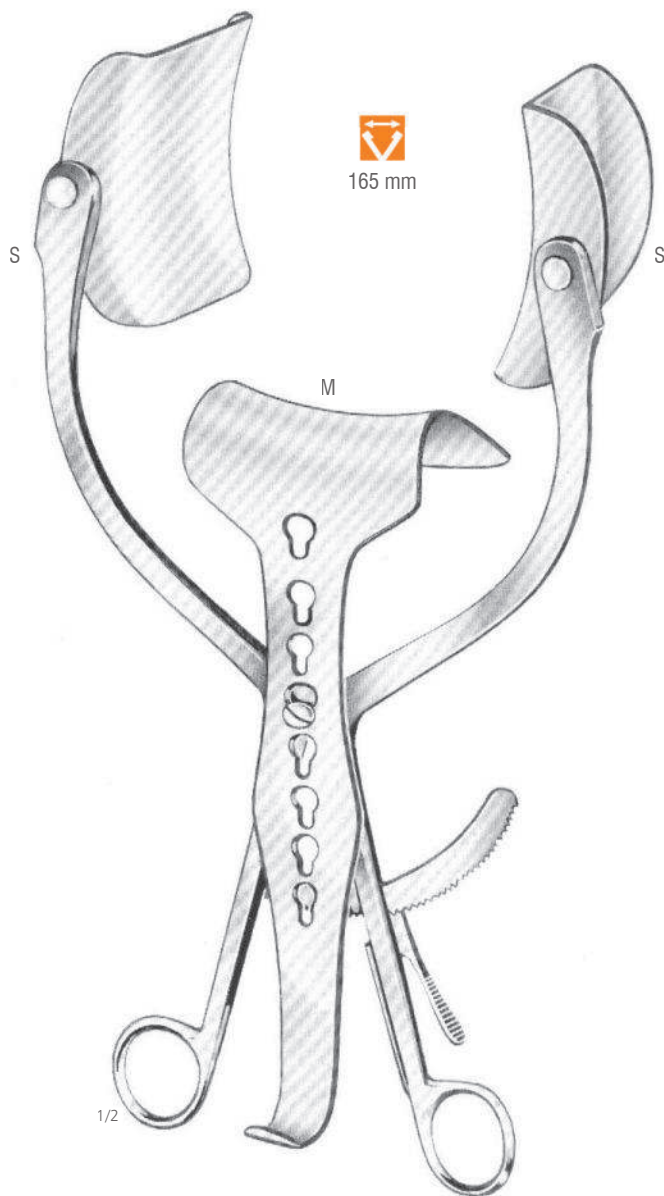

Collin	S	M
09-792-00	50 x 58 mm	62 x 67 mm
09-793-00	62 x 80 mm	62 x 67 mm

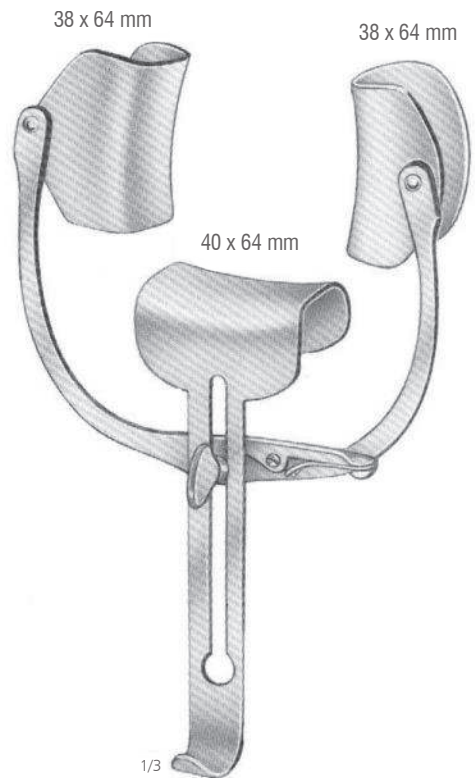

Robin - Masse  
09-796-00

TRIMED Exchangeable Blades  
Measurement of blades: Depth x Width

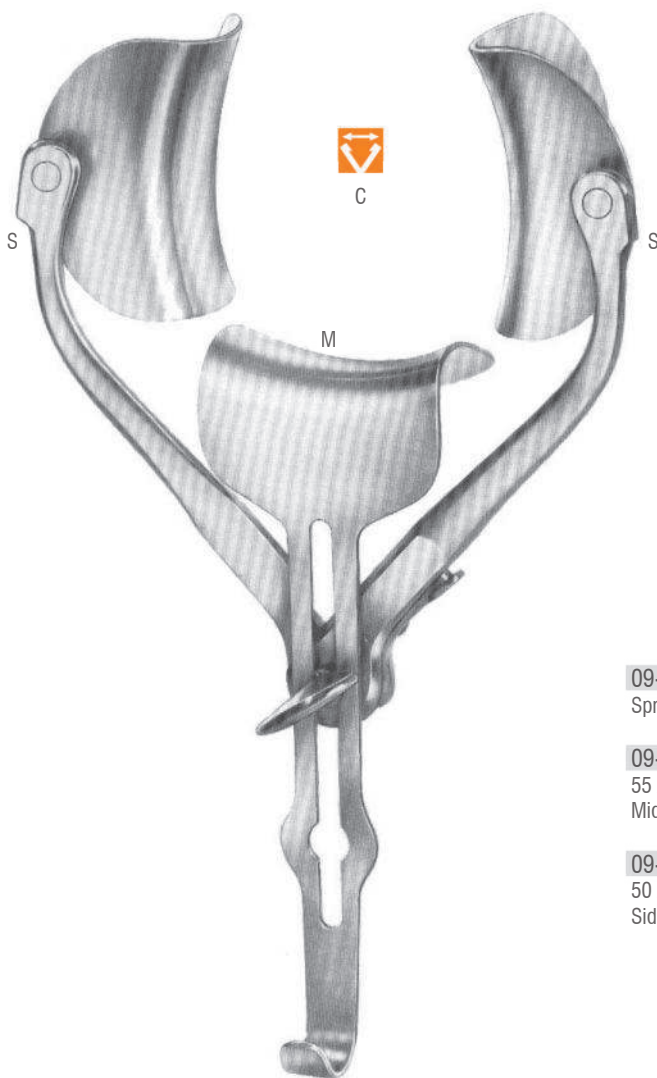

09-800-01  
Spreader only

09-802-02  
55 x 70 mm  
Middle blade

09-802-04  
80 x 90 mm

09-809-90  
50 x 58 mm  
Side blades

09-809-92  
72 x 85 mm

09-909-94  
72 x 85 mm

Ricard

	S	M	C
09-800-00	72 x 85 mm	80 x 90 mm	28 cm
09-800-00	60 x 80 mm	55 x 70 mm	30 cm

Complete



TRIMED Exchangeable Blades  
 Measurement of blades: Depth x Width

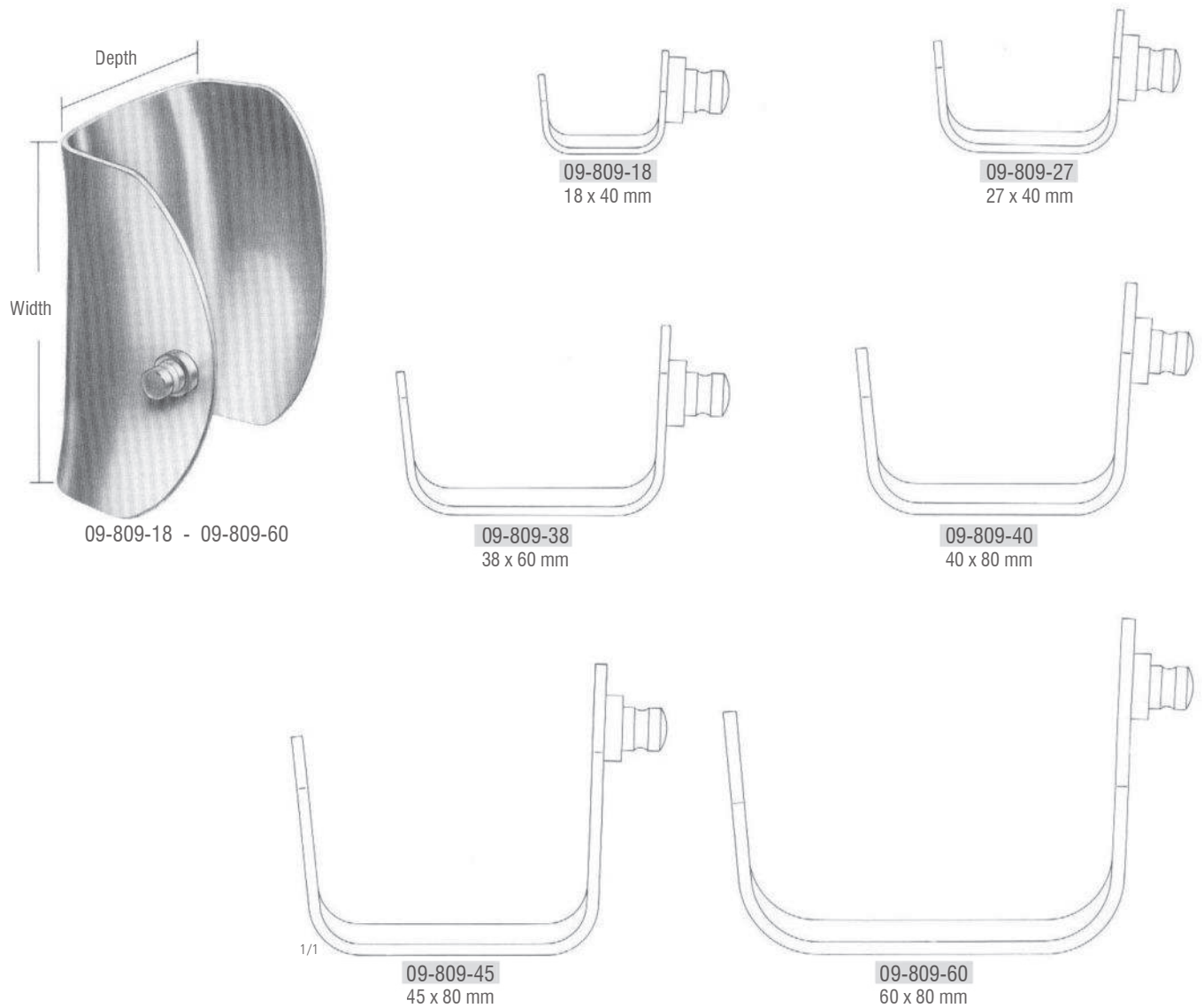

TRIMED Exchangeable Blades  
 Fitting the following models



TRIMED Exchangeable Blades  
 Measurement of blades: Depth x Width

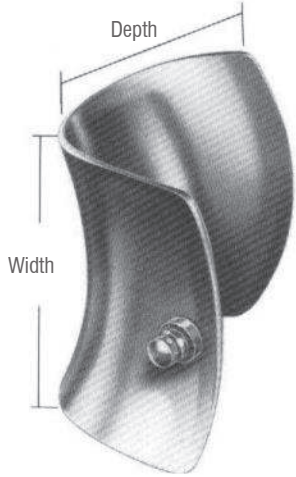

09-809-50 - 09-809-94

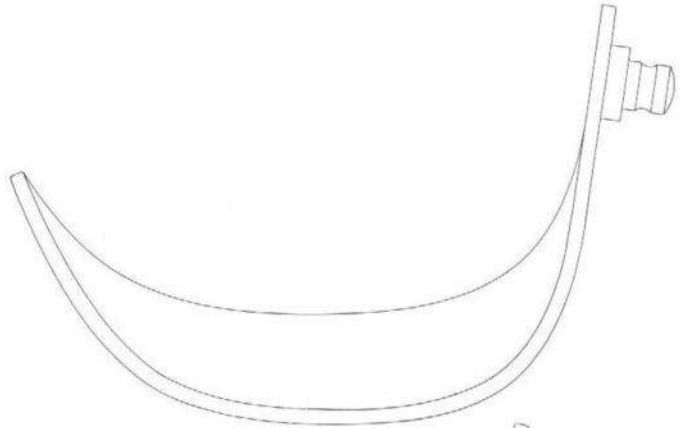

09-809-80  
 80 x 90 mm

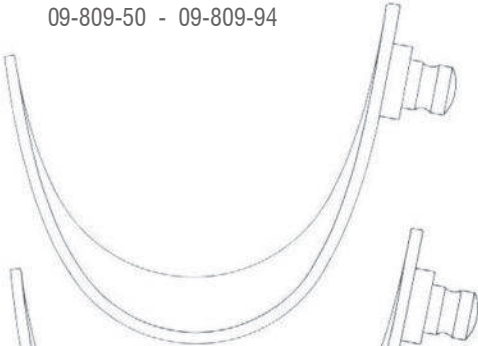

09-809-50  
 50 x 70 mm

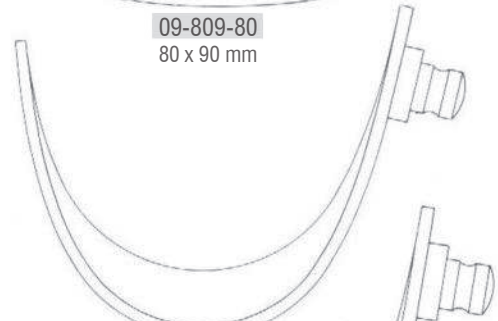

09-809-90  
 50 x 58 mm



09-809-52  
 52 x 110 mm

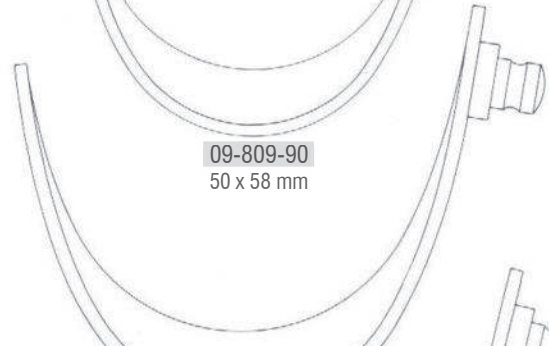

09-809-92  
 60 x 80 mm

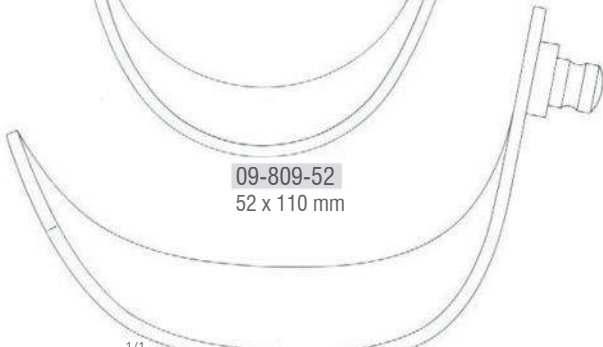

09-809-70  
 70 x 55 mm

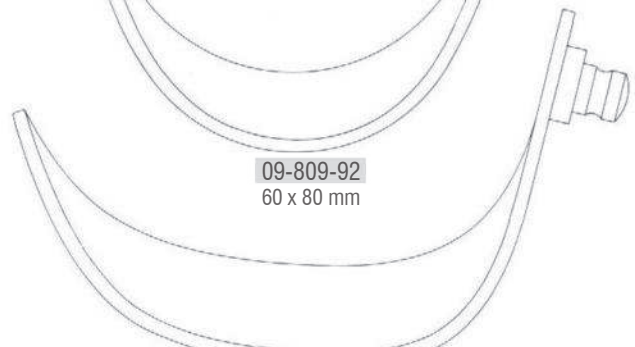

09-809-94  
 72 x 85 mm

TRIMED Exchangeable Blades  
 Fitting the following models



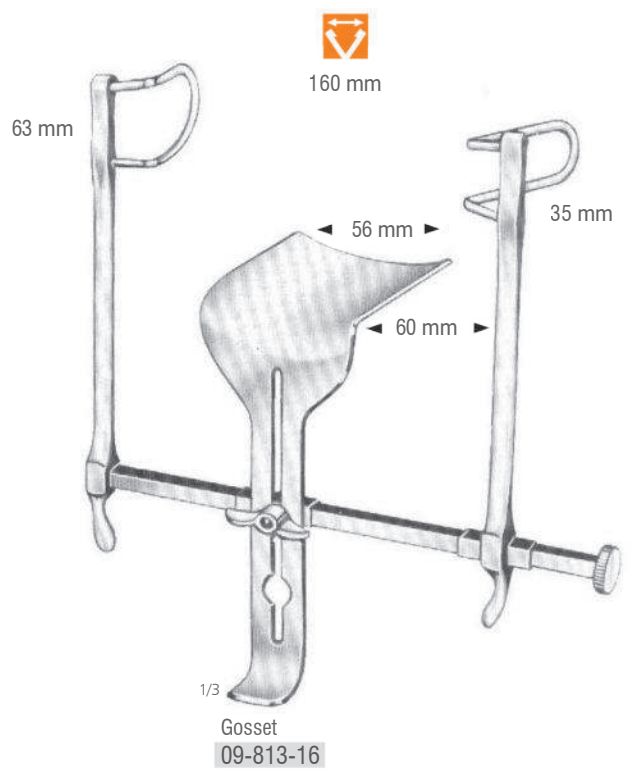
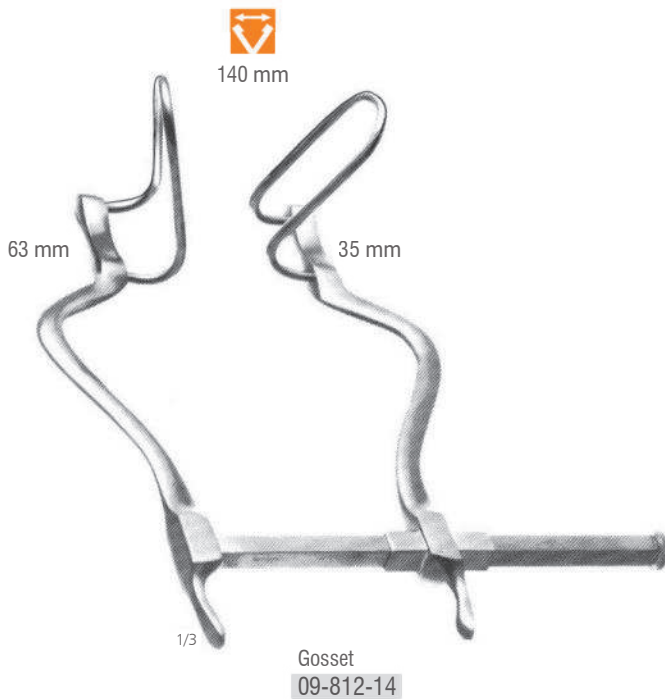
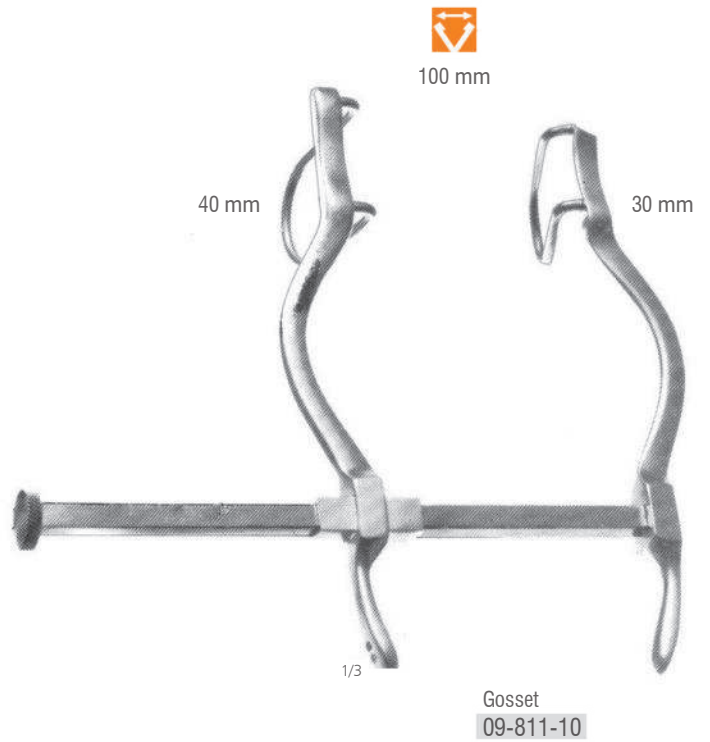

Measurement of blades: Depth x Width



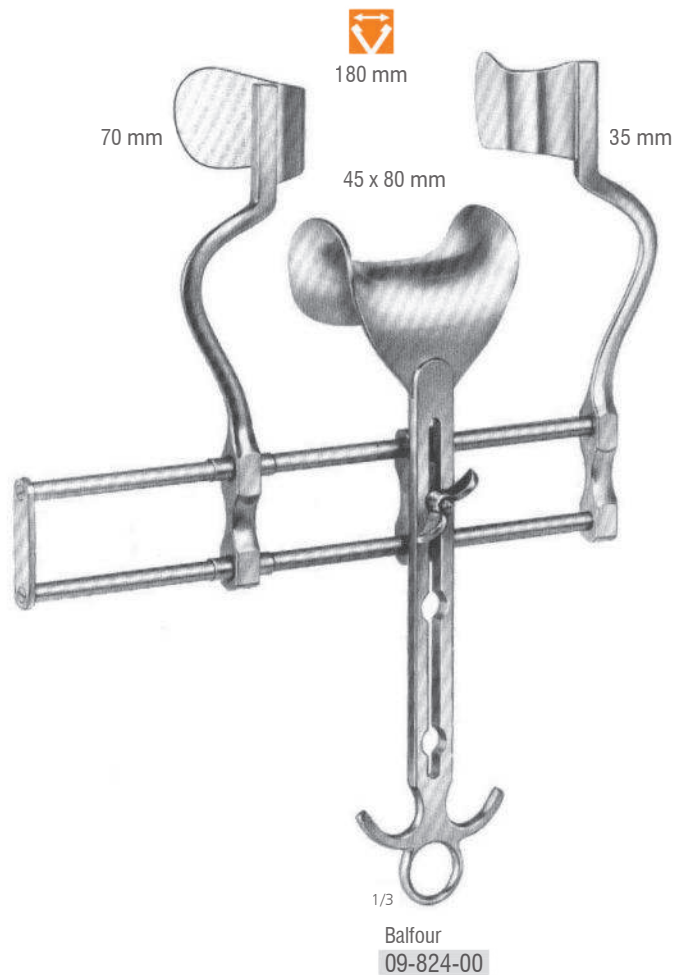
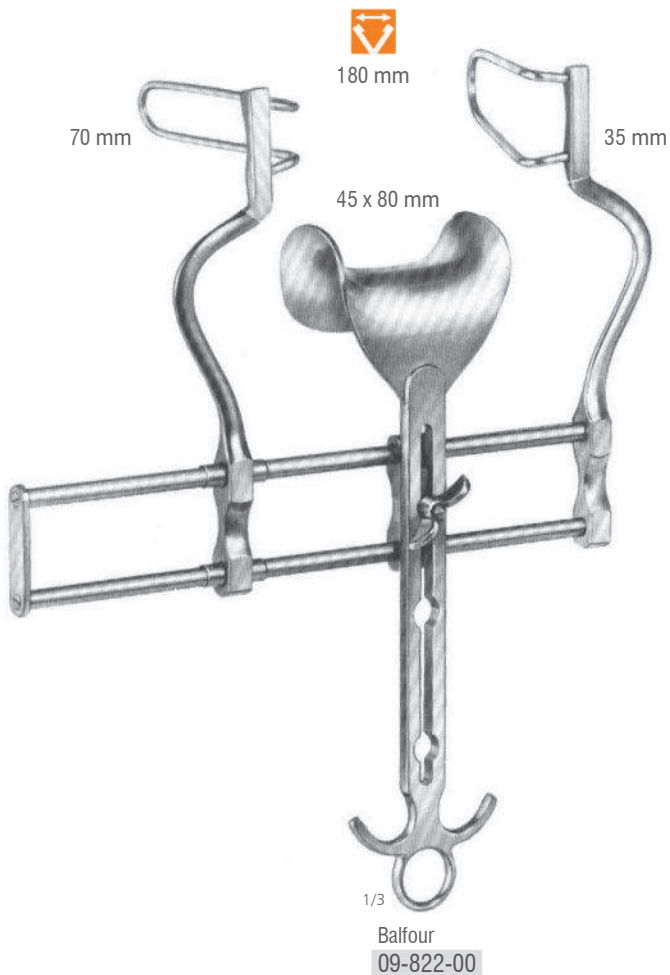
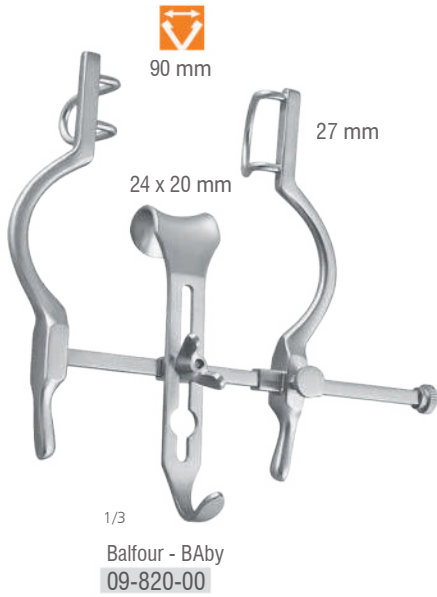

Measurement of blades: Depth x Width

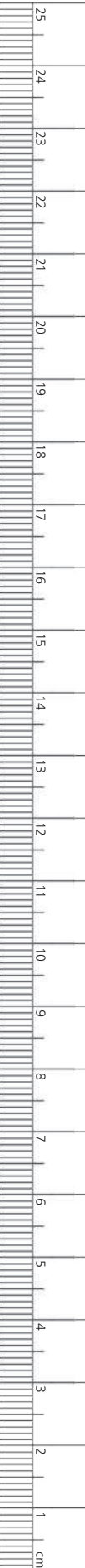

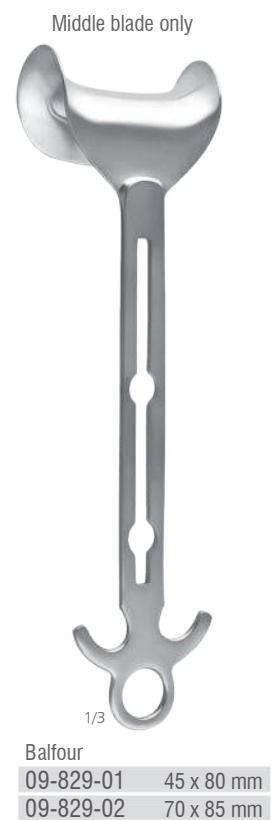
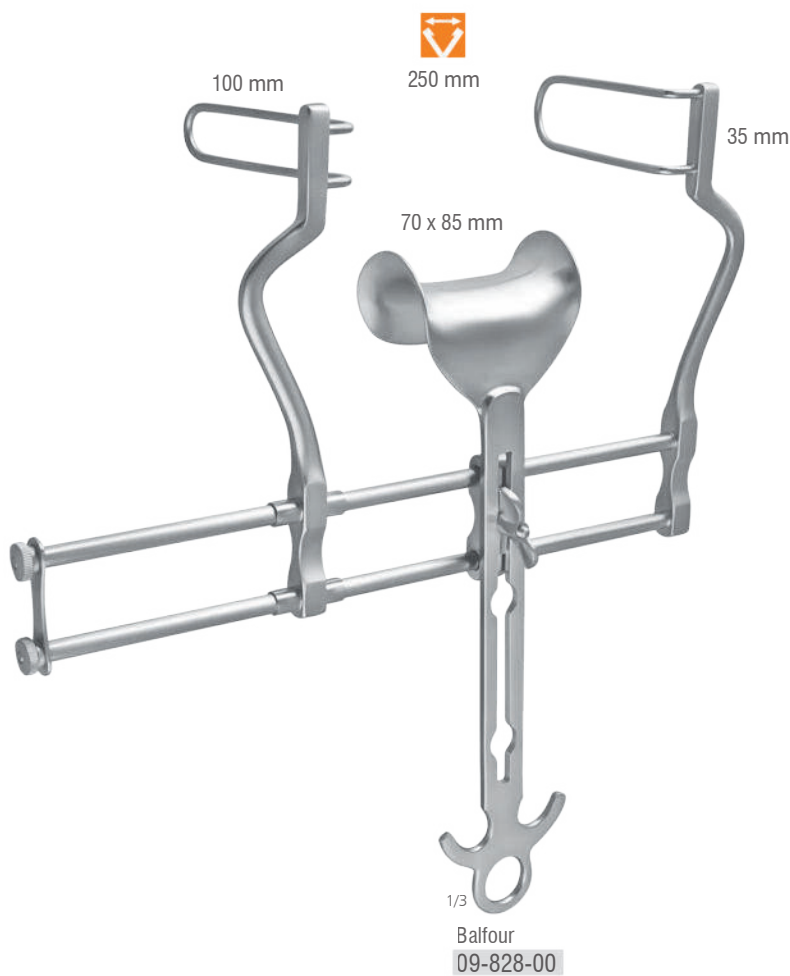
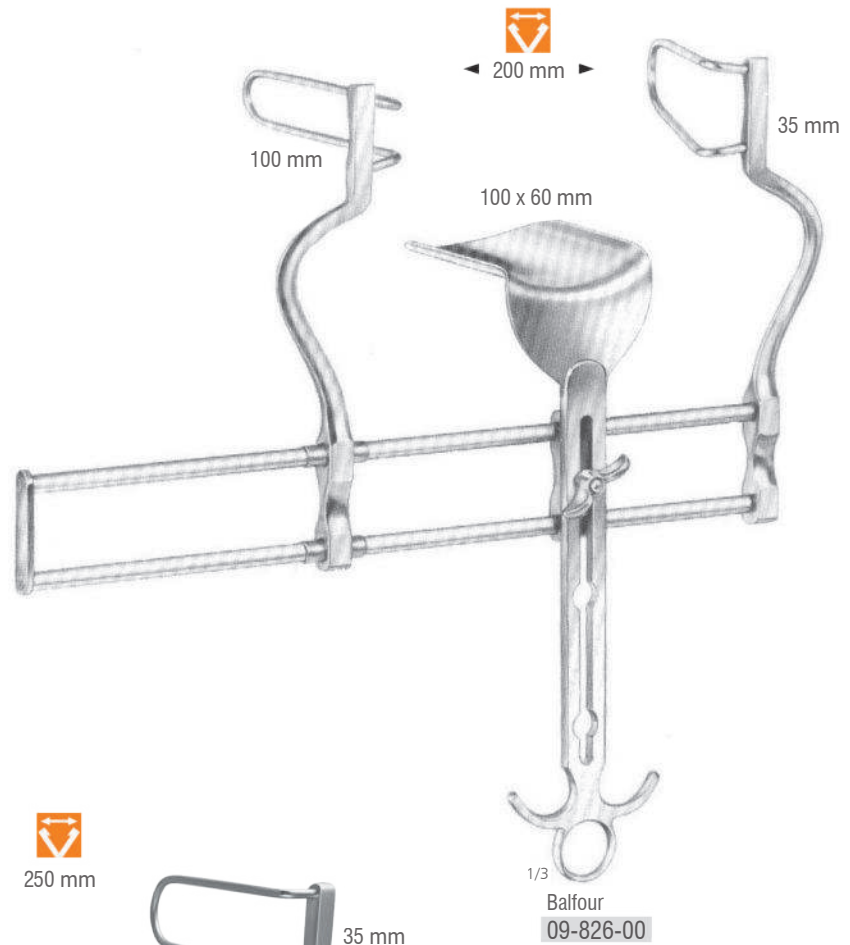

Measurement of blades: Depth x Width

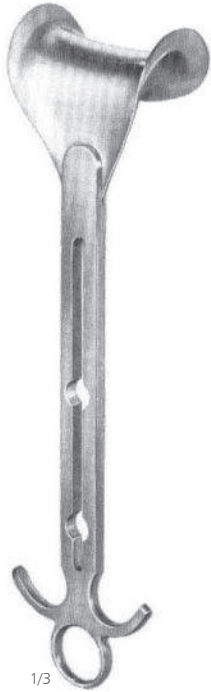

Balfour  
09-829-05  
Middle blade, 68 x 85 mm

09-829-06  
Middle blade, 40 x 68 mm

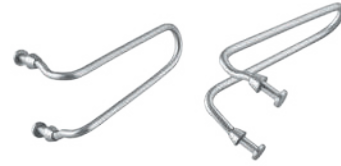

09-830-06  
Side blades, 60 mm deep, per pair

09-830-08  
Side blades, 80 mm deep, per pair

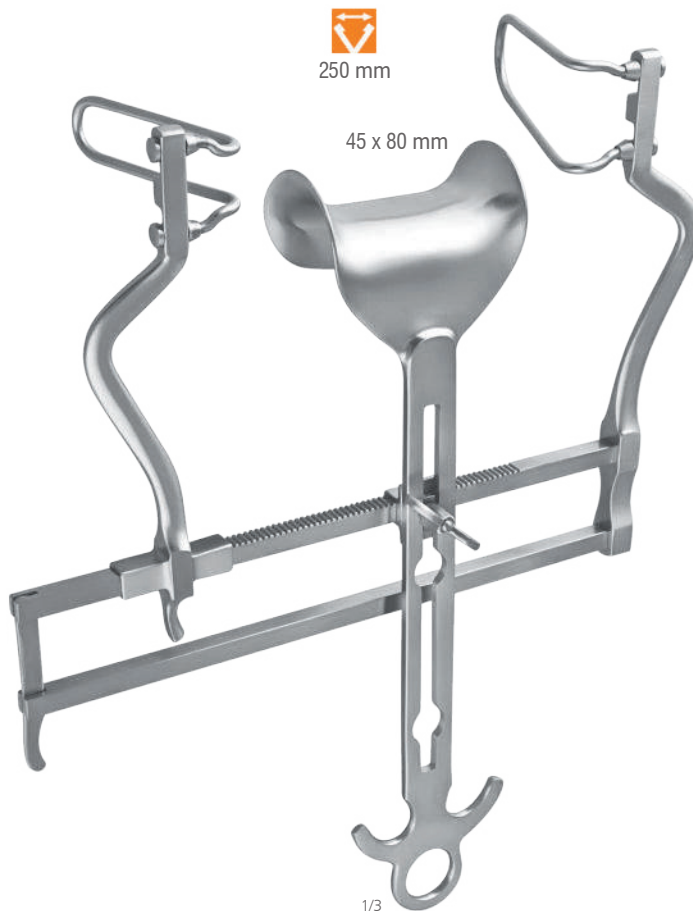

 250 mm

45 x 80 mm

1/3  
Balfour US - Type  
09-830-00  
Complete

Measurement of blades: Depth x Width

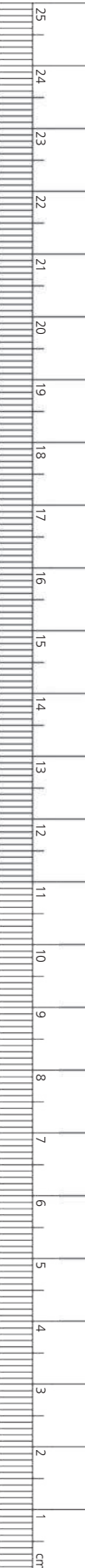

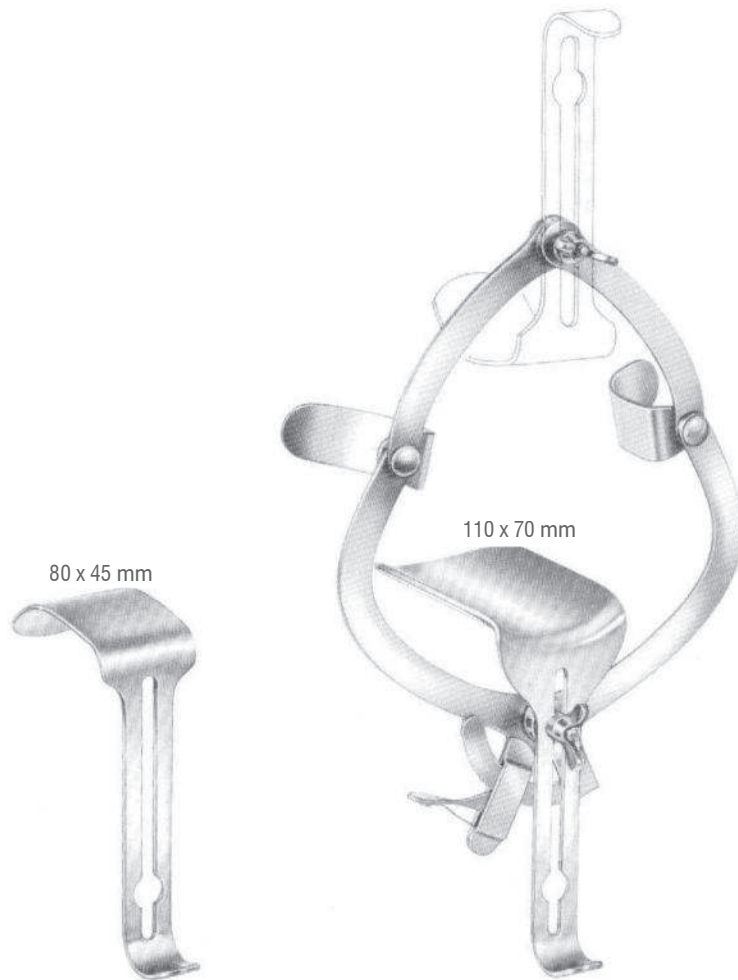

O'Sullivan - O'Connor  
09-838-00

Measurement of blades: Depth x Width

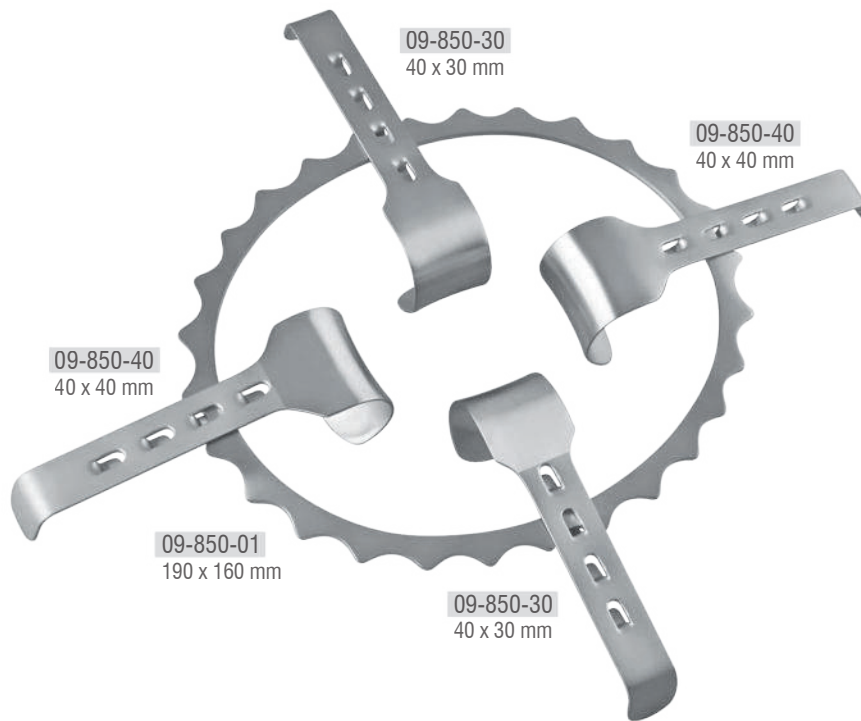

Denis Browne  
09-850-00 Complete

Consisting

09-850-01	x 1
09-850-30	x 2
09-850-40	x 2

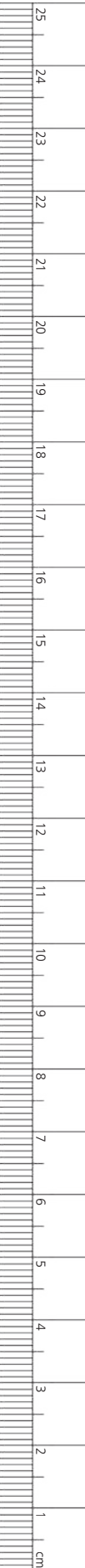



Doyen

09-855-01	55 x 95 mm
09-855-02	55 x 105 mm
09-855-03	55 x 115 mm
09-855-04	55 x 125 mm

28 cm

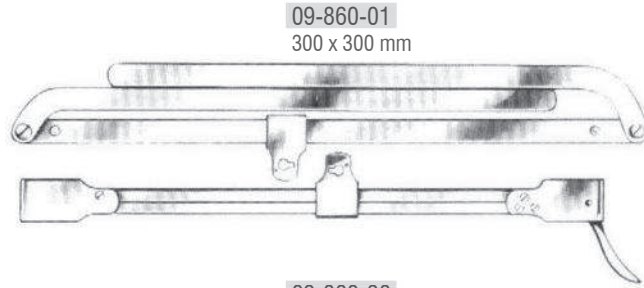

09-860-01  
300 x 300 mm

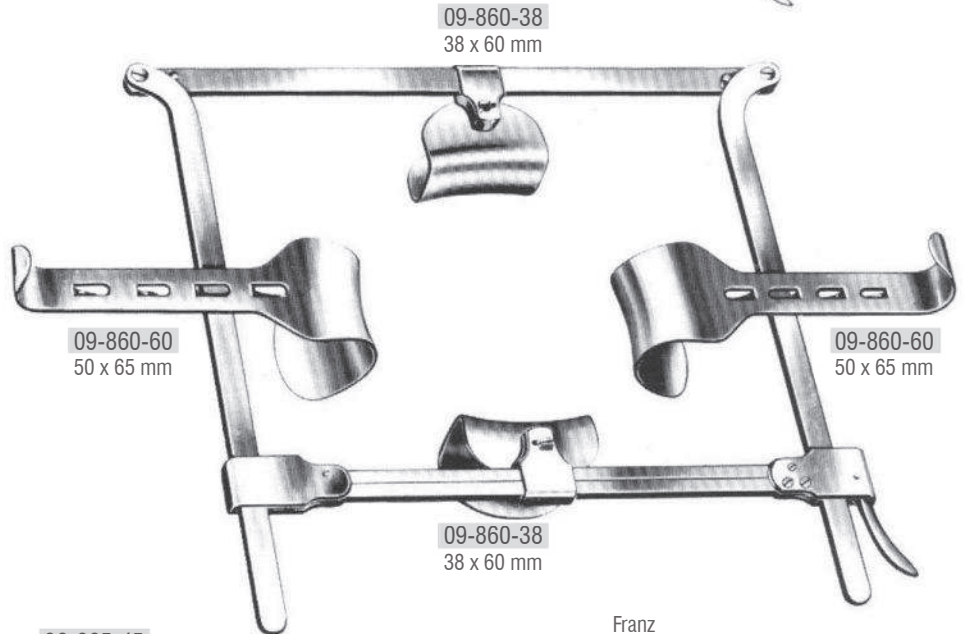

09-860-38  
38 x 60 mm

09-860-60  
50 x 65 mm

09-860-60  
50 x 65 mm

09-860-38  
38 x 60 mm



09-865-45  
45 x 80 mm



09-865-60  
60 x 85 mm



09-865-60  
60 x 85 mm



09-865-45  
45 x 80 mm

Franz

09-860-00 Complete

Consisting

09-860-01	x 1
09-860-38	x 2
09-860-50	x 2

Franz

09-865-00 Complete

Consisting

09-860-01	x 1
09-860-38	x 2
09-860-50	x 2
09-860-45	x 2
09-860-60	x 2

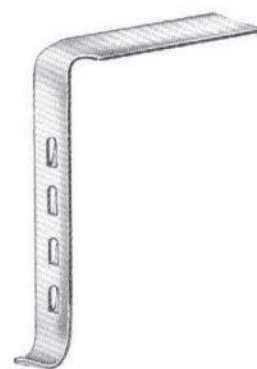

09-866-35  
105 x 35 mm



09-866-50  
98 x 50 mm

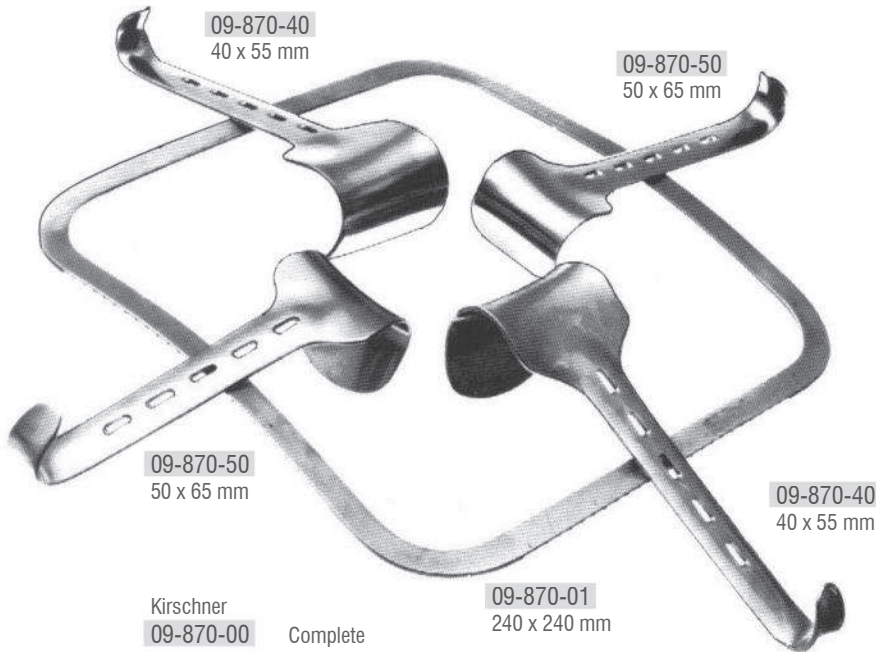

Kirschner  
09-870-00 Complete

- Consisting
- 09-870-01 x 1
  - 09-870-40 x 2
  - 09-870-50 x 2

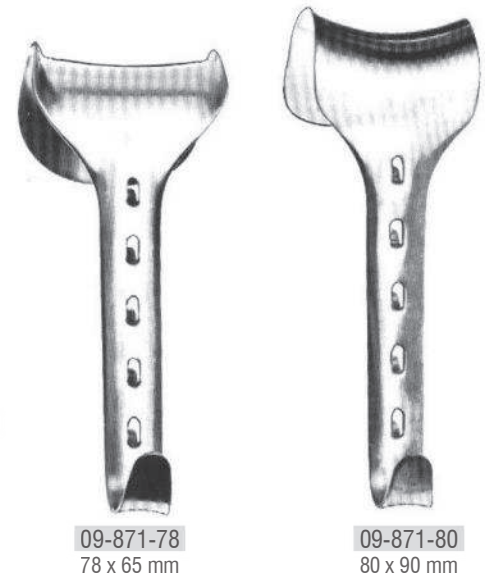

09-871-78  
78 x 65 mm

09-871-80  
80 x 90 mm

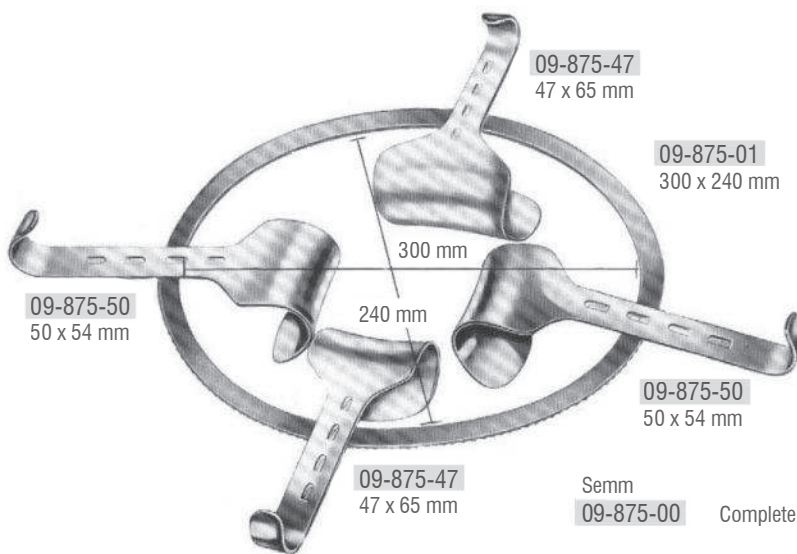

Semm  
09-875-00 Complete

- Consisting
- 09-875-01 x 1
  - 09-875-47 x 2
  - 09-875-50 x 2
  - 09-876-01 x 1
  - 09-876-02 x 1

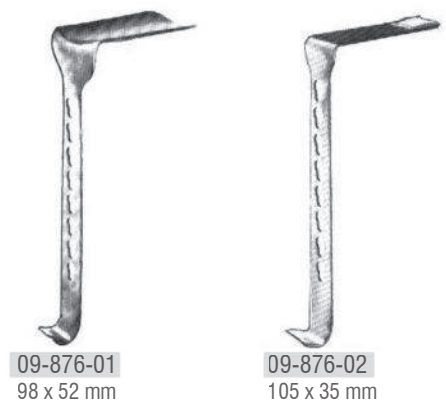

09-876-01  
98 x 52 mm

09-876-02  
105 x 35 mm

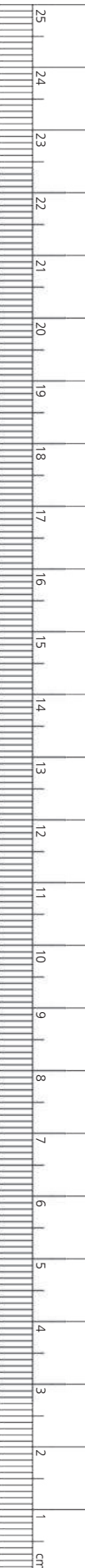



150 mm

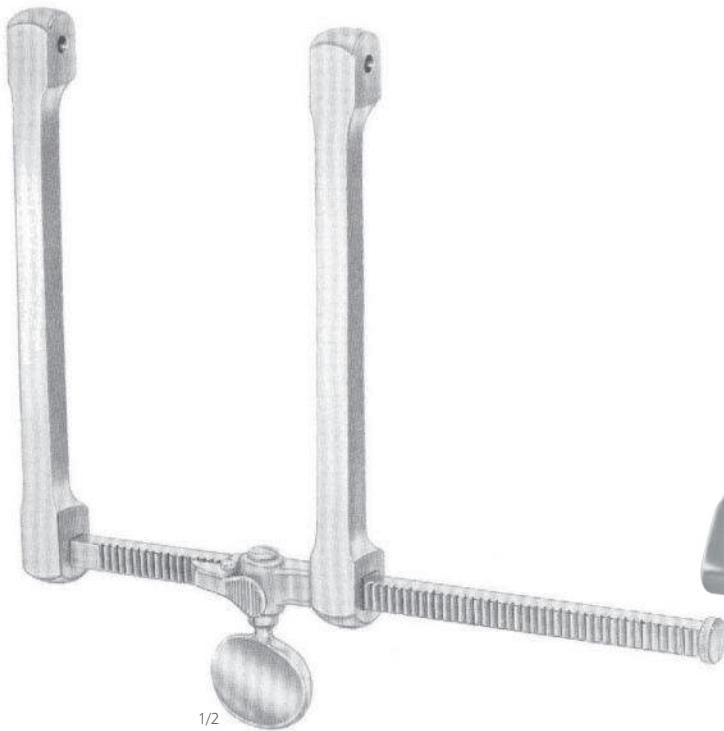

1/2

Scoville  
 09-890-00  
 Frame only



150 mm

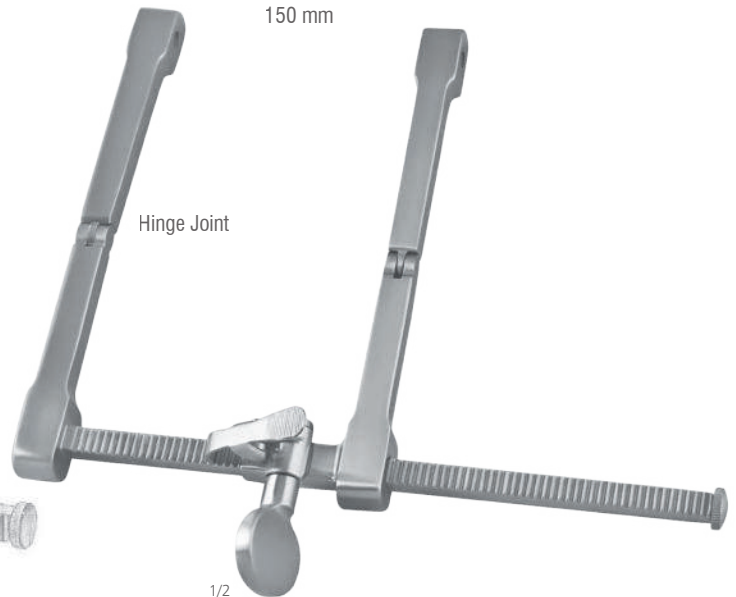

Hinge Joint

1/2

Scoville - Haverfield  
 09-890-50  
 Frame only





1/2  
Scoville  
09-890-01  
50 mm



Scoville  
09-890-02  
70 mm



Scoville  
09-890-06  
50 mm



Scoville  
09-890-07  
70 mm



1/2  
Scoville  
09-890-11 64 x 25 mm  
09-890-12 64 x 50 mm  
09-890-13 80 x 25 mm

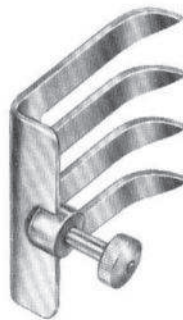

Taylor  
09-890-41 48 x 50 mm  
09-890-42 64 x 50 mm  
09-890-43 64 x 64 mm  
09-890-44 80 x 57 mm

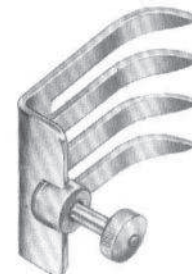

Scoville  
09-890-46 41 x 38 mm  
09-890-47 67 x 44 mm



Malleable



09-950-06	200 x 6.5 mm
09-950-09	200 x 9.5 mm
09-950-13	200 x 13 mm
09-950-16	200 x 16 mm
09-950-17	200 x 17 mm
09-950-19	200 x 19 mm
09-950-25	200 x 25 mm
09-952-25	250 x 25 mm

Malleable



09-956-30	30 mm
09-956-40	40 mm
09-956-50	50 mm
	33 cm

Malleable



25 mm

Tuffier  
09-962-22  
22 cm

17 mm



Haberer

09-968-30	25/30 mm	28 cm
09-968-45	37/45 mm	30 cm
09-968-50	40/50 mm	30 cm



Haberer

09-974-29  
39 cm

