

34

Neurosurgery  
Neurochirurgie  
Neurocirugía  
Neurochirurgie

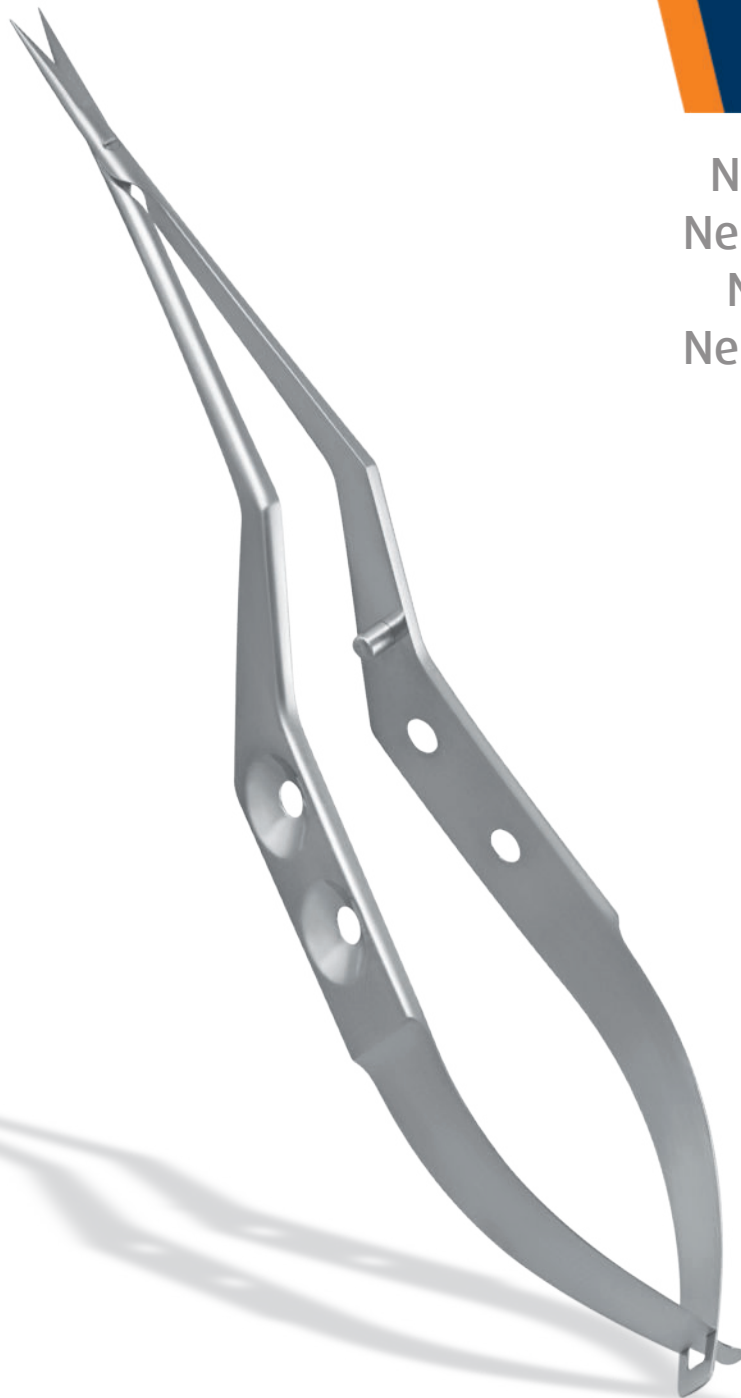



1/1

	34-100-12	12 cm	II
	34-100-16	16 cm	II
Millesi	34-104-16	16 cm	II
Yasargil	34-108-18	18.5 cm	II



	34-101-12	12 cm	II
	34-101-16	16 cm	II
Millesi	34-105-16	16 cm	II
Jacobson	34-109-18	18.5 cm	II



1/1

34-100-12 - 34-135-18



1/1

	Vannas		
	34-120-12	12 cm	II
	34-120-16	16 cm	II



Vannas

	34-121-12	12 cm	II
	34-121-16	16 cm	II



1/1

	Biemer		
	34-131-13	13 cm	II



Vannas

	34-133-12	12 cm	II
--	-----------	-------	----



Potts - Yasargil

	34-135-18	18.5 cm	II
--	-----------	---------	----



1/1

	34-140-12	12 cm	II
	34-140-16	16 cm	II
Millesi	34-144-16	16 cm	II
Yasargil	34-148-18	18.5 cm	II



	34-141-12	12 cm	III
	34-141-16	16 cm	III
Millesi	34-145-16	16 cm	III
Jacobson	34-149-18	18.5 cm	III



1/1

	Vannas		
	34-160-12	12 cm	II
	34-160-16	16 cm	II



	Vannas		
	34-161-12	12 cm	III
	34-161-16	16 cm	III



1/1

	Biemer		
	34-171-13		II
	13 cm		



	Vannas		
	34-173-12		II
	12 cm		



	Potts - Yasargil		
	34-175-18		II
	18.5 cm		



34-140-12 - 34-175-18

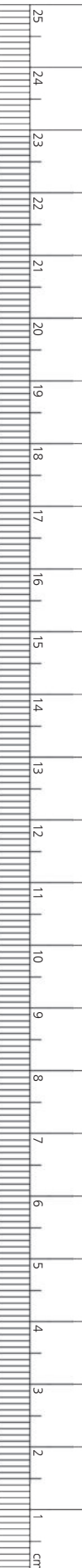

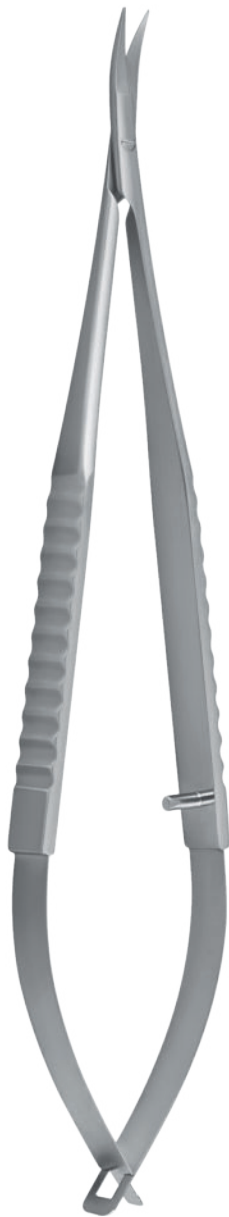

34-180-16 - 34-189-24



34-180-16	16 cm	II
34-180-20	20 cm	II
34-180-24	24 cm	II



34-181-16	16 cm	II
34-181-20	20 cm	II
34-181-24	24 cm	II



34-184-16	16 cm	II
34-184-20	20 cm	II
34-184-24	24 cm	II



34-185-16	16 cm	II
34-185-20	20 cm	II
34-185-24	24 cm	II



34-188-16	16 cm	II
34-188-20	20 cm	II
34-188-24	24 cm	II



34-189-16	16 cm	II
34-189-20	20 cm	II
34-189-24	24 cm	II



34-190-16 - 34-199-24



1/1

34-190-16	16 cm	
34-190-20	20 cm	
34-190-24	24 cm	



34-191-16	16 cm	
34-191-20	20 cm	
34-191-24	24 cm	



34-193-16	16 cm	
34-193-20	20 cm	
34-193-24	24 cm	



1/1

34-194-16	16 cm	
34-194-20	20 cm	
34-194-24	24 cm	



34-195-16	16 cm	
34-195-20	20 cm	
34-195-24	24 cm	



1/1

34-198-16	16 cm	
34-198-20	20 cm	
34-198-24	24 cm	



34-199-16	16 cm	
34-199-20	20 cm	
34-199-24	24 cm	

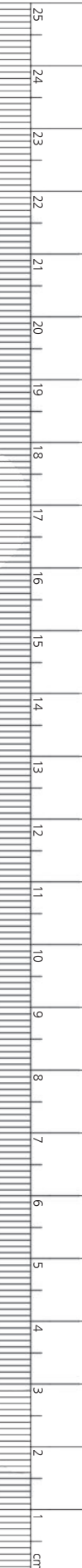

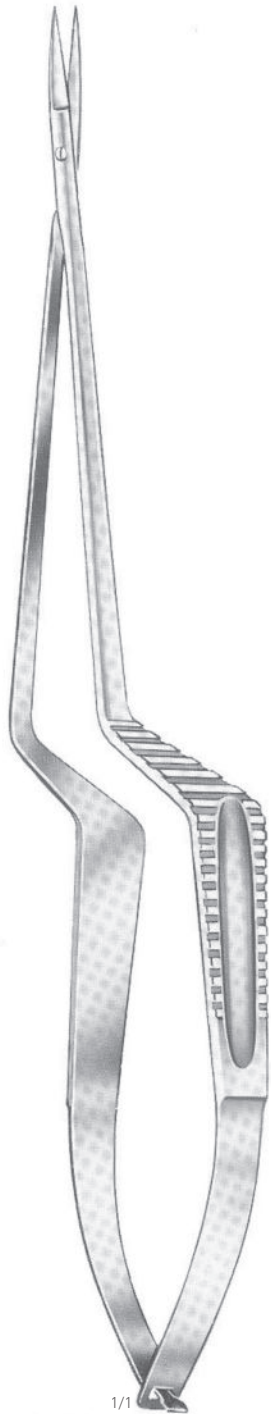

34-220-18 - 34-227-19  
 19 cm



34-220-19



34-221-19



34-226-19



34-227-19



1/1  
 34-240-16 16.5 cm   
 34-240-20 20 cm 



34-241-16 16.5 cm   
 34-241-20 20 cm 



34-243-16 16.5 cm   
 34-243-20 20 cm 



1/1  
 34-246-20   
 20 cm



34-247-20   
 20 cm



1/1  
 Yasargil  
 34-240-16 - 34-247-20

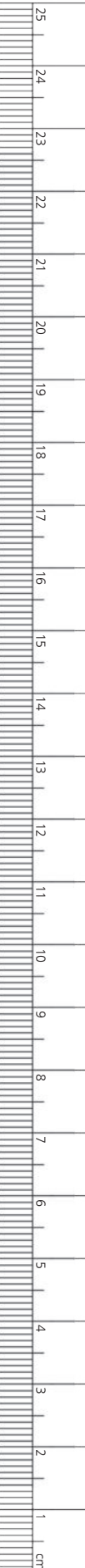

Micro Spring Type Scissors, bayonet - shaped  
 Mikro - Federschere, bajonettförmig  
 Tijeras tipo micro resorte, en forma de bayoneta  
 Ciseaux à micro-ressorts en forme de baïonnette



1/1  
 34-260-22 - 34-277-22  
 22.5 cm



1/1  
 Yasargil  
 34-260-22



1/1  
 Yasargil  
 34-261-22



1/1  
 Yasargil  
 34-263-22



1/1  
 Vannas  
 34-270-22



1/1  
 Vannas  
 34-271-22



1/1  
 Yasargil  
 34-276-22



1/1  
 Yasargil  
 34-277-22





1/1  
 34-283-20 - 34-287-19



1/1

Nagel

34-283-20   
 20 cm







34-285-20   
 20 cm

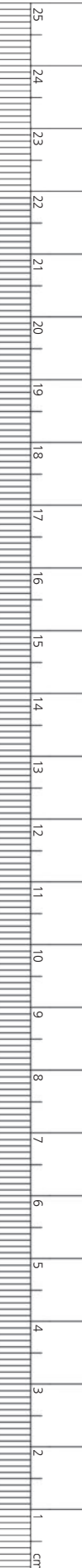

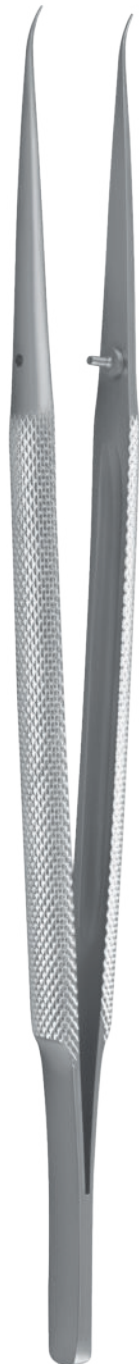

34-287-19   
 19 cm







34-320-15	15 cm	
34-320-18	18 cm	
34-320-21	21 cm	
0.4 mm		





34-321-15	15 cm	
34-321-18	18 cm	
34-321-21	21 cm	
0.4 mm		



34-324-15	15 cm	
34-324-18	18 cm	
34-324-21	21 cm	
0.8 mm		



34-325-15	15 cm	
34-325-18	18 cm	
34-325-21	21 cm	
0.8 mm		

34-320-15 - 34-325-21

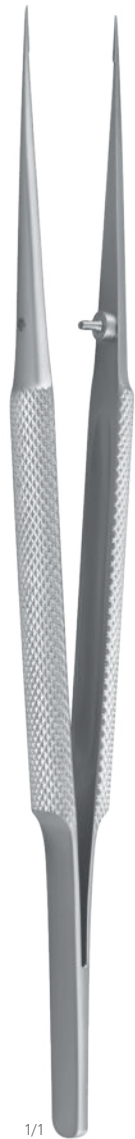

1/1  
 34-330-12 - 34-335-23



1/1  

34-330-12	12 cm	
34-330-15	15 cm	
34-330-18	18 cm	

 0.3 mm



1/1  

34-331-12	12 cm	
34-331-15	15 cm	
34-331-18	18 cm	

 0.3 mm



1/1  

34-334-18	18 cm	
34-334-21	21 cm	
34-334-23	23 cm	

 0.6 mm



1/1  

34-335-18	18 cm	
34-335-21	21 cm	
34-335-23	23 cm	

 0.6 mm

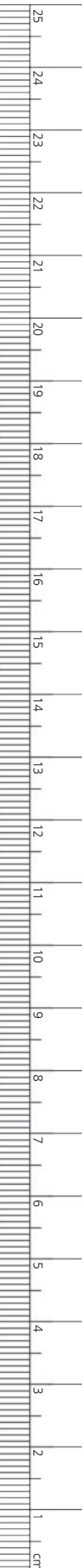



34-340-15	15 cm	II
34-340-18	18 cm	II
34-340-21	21 cm	II
Ø 1.0 mm		



34-342-15	15 cm	II
34-342-18	18 cm	II
34-342-21	21 cm	II
Ø 2.0 mm		

Serrated jaws

34-346-15	15 cm	II
34-346-18	18 cm	II
34-346-21	21 cm	II
Ø 1.0 mm		

34-348-15	15 cm	II
34-348-18	18 cm	II
34-348-21	21 cm	II
Ø 2.0 mm		

Diamond dusted jaws



34-340-15 - 34-348-21



De Bakey  
34-360-15 - 34-367-21



1/1

34-360-15	15 cm	
34-360-18	18 cm	
34-360-21	21 cm	
1.2 mm		



34-361-15	15 cm	▶
34-361-18	18 cm	▶
34-361-21	21 cm	▶
1.2 mm		



1/1

34-366-15	15 cm	
34-366-18	18 cm	
34-366-21	21 cm	
1.8 mm		



34-367-15	15 cm	▶
34-367-18	18 cm	▶
34-367-21	21 cm	▶
1.8 mm		

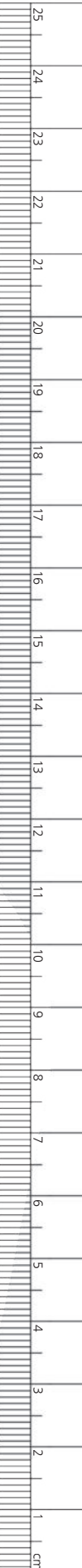



Vise  
 34-380-12 - 34-385-13



1/1  
**34-380-12** II  
 12 cm  
 0.3 mm



**34-384-13** II  
 13.5 cm  
 0.3 mm



**34-385-13** III  
 13.5 cm  
 0.3 mm



Austin  
 34-390-09 - 34-394-18



1/1  
**34-390-09** II  
 9.5 cm  
 0.2 mm  
 1:2 Teeth

**34-394-14** II  
 14 cm  
 0.8 mm

**34-394-18** II  
 18 cm  
 0.8 mm

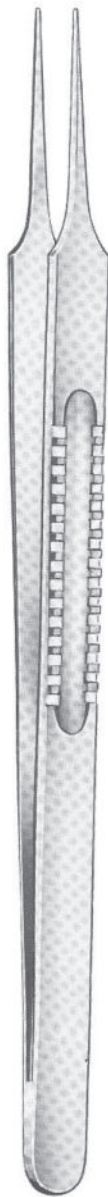

Lazer  
 34-400-15 - 34-408-18



1/1  
 34-400-15 ■■  
 15.5 cm  
 0.5 mm



34-404-15 ■■  
 15.5 cm  
 0.8 mm



34-408-18 ■■  
 18.5 cm  
 0.5 mm

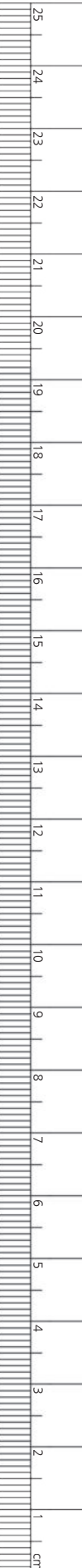



34-410-16 - 34-316-24



34-410-16	16 cm	II
34-410-20	20 cm	I
34-410-24	24 cm	II
0.9 mm		



34-411-16	16 cm	I
34-411-20	20 cm	I
34-411-24	24 cm	I
0.9 mm		



34-416-16	16 cm	
34-416-20	20 cm	
34-416-24	24 cm	
Ø 7.0 mm		

34-420-16	16 cm	II
34-420-20	20 cm	II
34-420-24	24 cm	II
0.9 mm		

34-421-16	16 cm	I
34-421-20	20 cm	I
34-421-24	24 cm	I
0.9 mm		

34-426-16	16 cm	
34-426-20	20 cm	
34-426-24	24 cm	
Ø 7.0 mm		



34-420-16 - 34-426-24



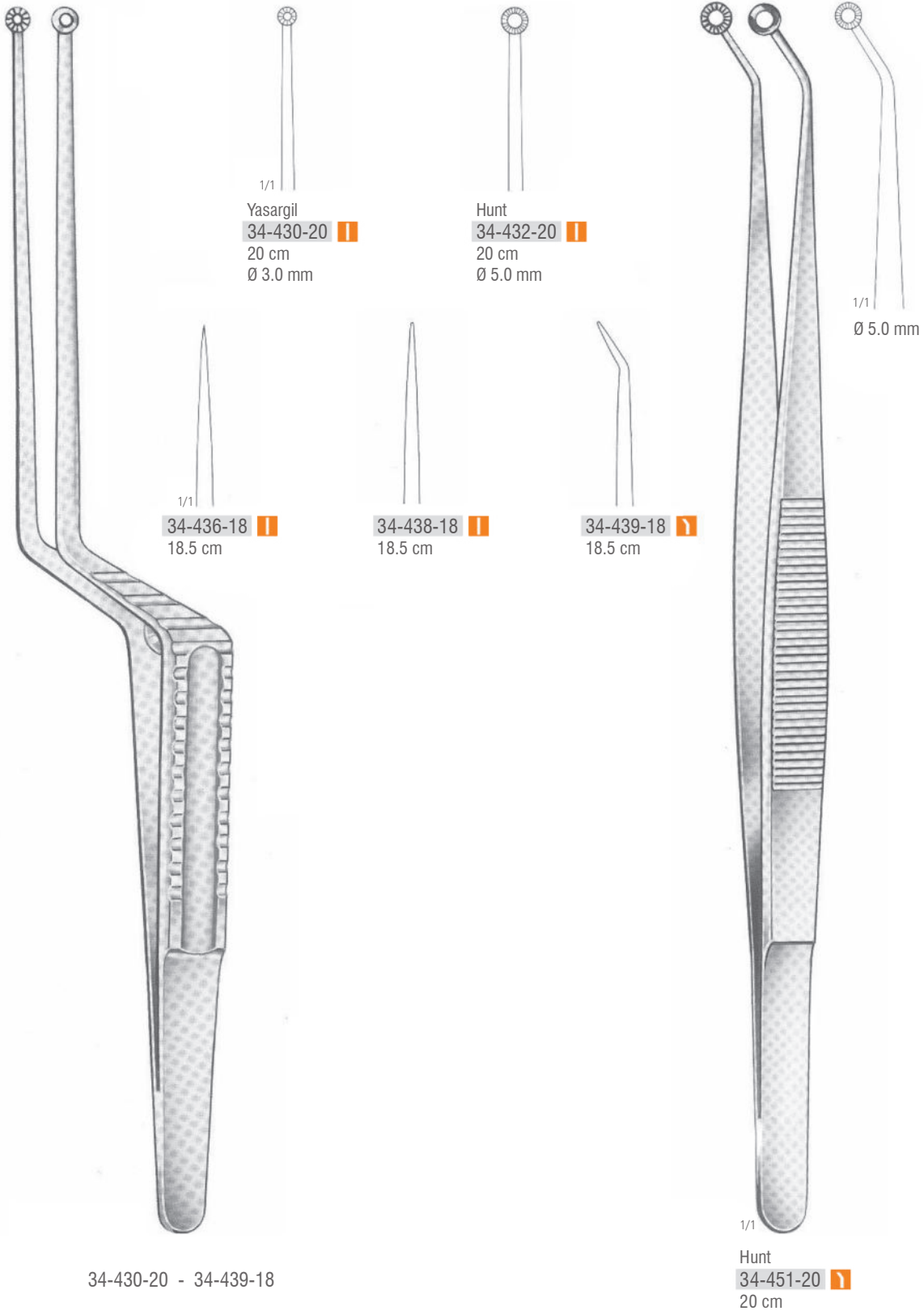

34-430-20 - 34-439-18



1/1

34-470-16	16 cm	II
34-470-18	18 cm	II
34-470-20	20 cm	II
34-470-22	22 cm	II
34-470-24	24 cm	II
0.6 mm		



34-474-16	16 cm	II
34-474-18	18 cm	II
34-474-20	20 cm	II
34-474-22	22 cm	II
34-474-24	24 cm	II
0.9 mm		



34-478-18	18 cm	II
1:2 Teeth		

Yasargil  
 34-470-16 - 34-478-18



34-490-03 - 34-500-05

1/1

Yasargil  
34-490-03  
22 cm  
Ø 3.0 mm

1/1

Yasargil  
34-490-05  
22 cm  
Ø 5.0 mm

1/1

Yasargil  
34-492-03  
22 cm  
Ø 3.0 mm

1/1

Yasargil  
34-492-05  
22 cm  
Ø 5.0 mm

1/1

Yasargil - Samii  
34-496-03  
24 cm  
Ø 3.0 mm

1/1

Yasargil - Samii  
34-496-05  
24 cm  
Ø 5.0 mm

1/1

Yasargil - Samii  
34-496-07  
24 cm  
Ø 7.0 mm

1/1

Heifetz  
34-500-03  
22 cm  
Ø 3.0 mm

1/1

Heifetz  
34-500-05  
22 cm  
Ø 5.0 mm

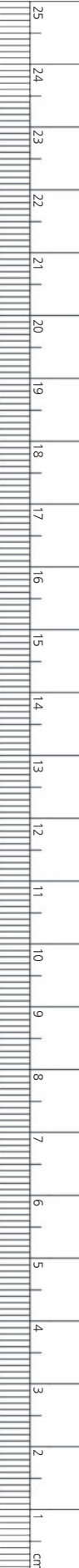

Tumor and Tissue Grasping Forceps, bayonet - shaped  
 Tumor- und Gewebefa pinzetten, bajonettförmig  
 Pinzas de agarre para tejido y tumor, en forma bayoneta  
 Pince à préhension tumorale et tissulaire, en forme de baïonnette

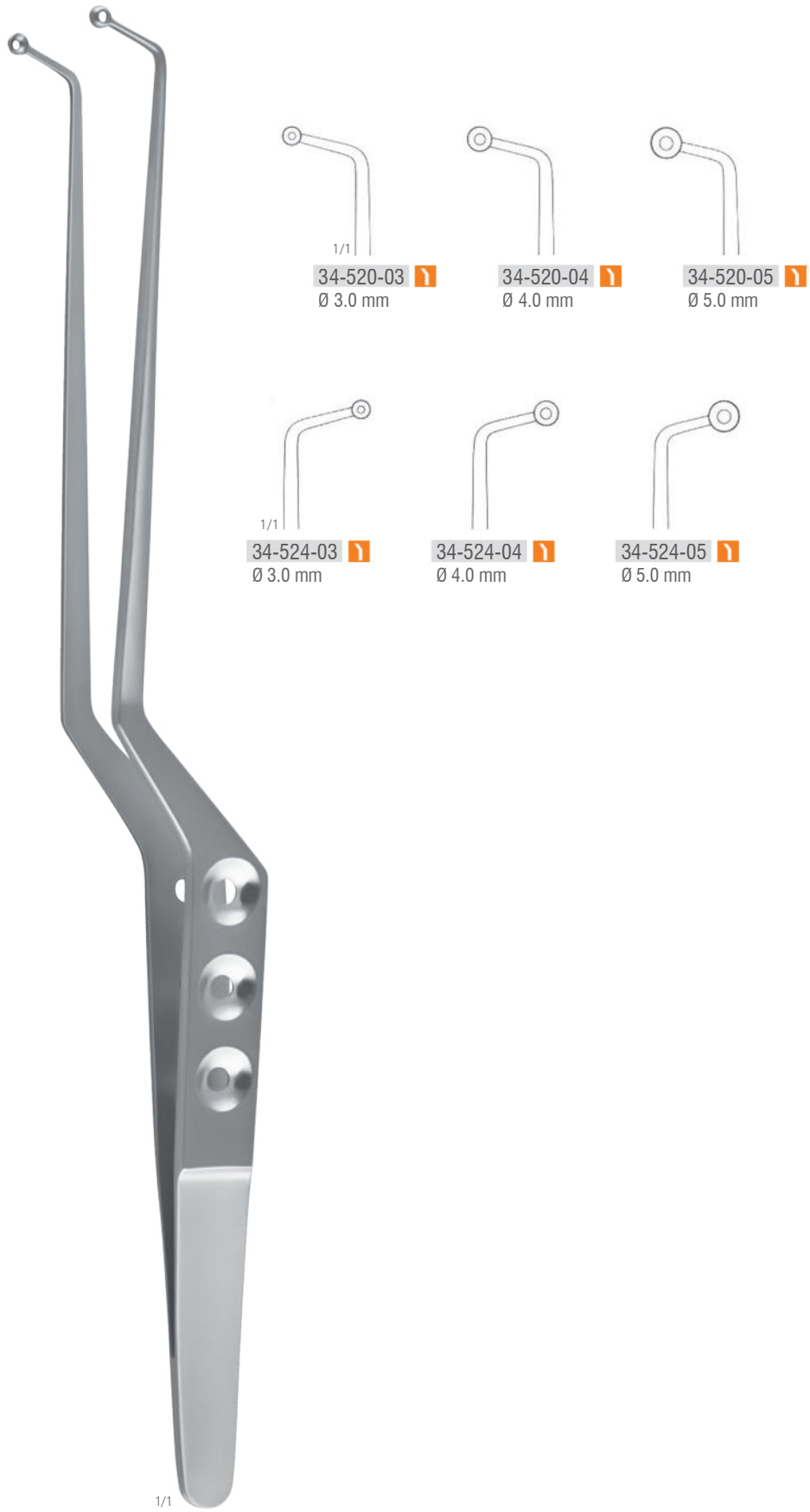

1/1  
 Samii  
 34-520-03 - 34-524-05  
 23 cm



34-600-16 - 34-605-18



34-600-16	16 cm	
34-600-18	18.5 cm	



34-601-16	16 cm	
34-601-18	18.5 cm	

Without catch



34-604-16	16 cm	
34-604-18	18.5 cm	







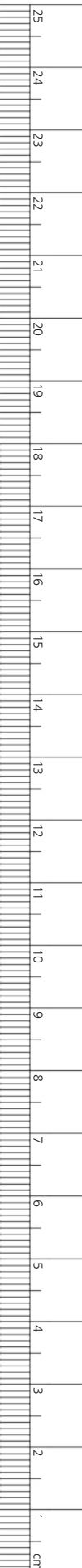

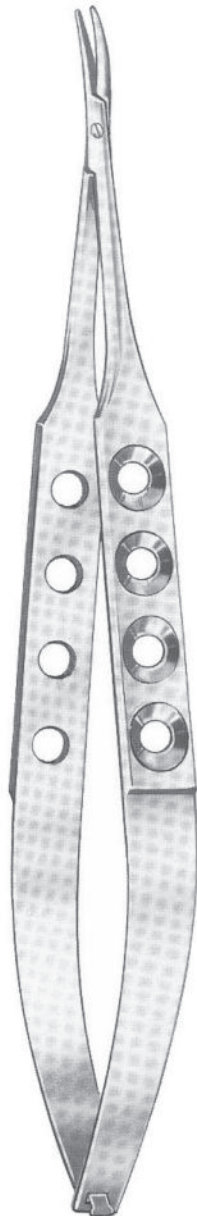
34-605-16	16 cm	
34-605-18	18.5 cm	

With catch









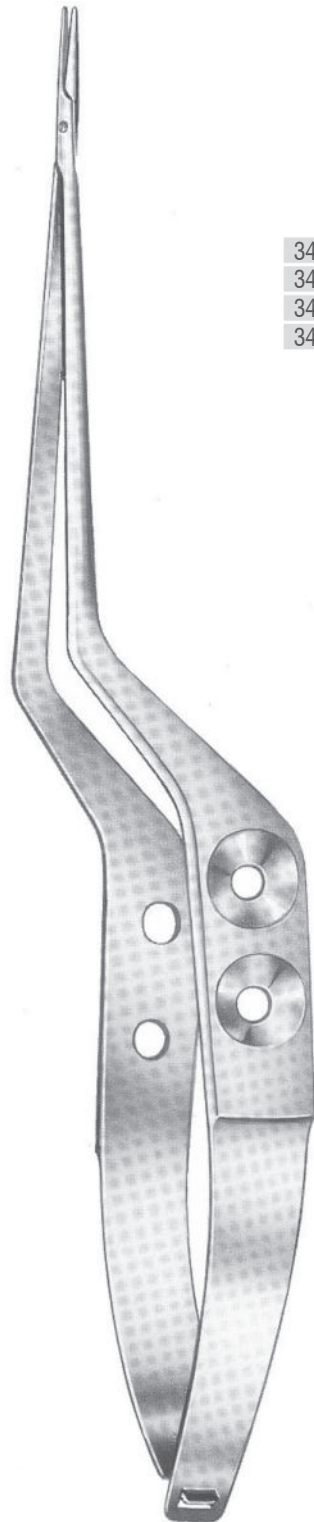



34-620-16 - 34-621-18

	
1/1	
34-620-16 16 cm 	34-621-16 16 cm 
34-620-18 18.5 cm 	34-621-18 18.5 cm 



34-626-16	16 cm	
34-626-20	20 cm	
34-626-22	22.5 cm	
34-626-24	24.5 cm	



34-627-16	16 cm	
34-627-20	20 cm	
34-627-22	22.5 cm	
34-627-24	24.5 cm	

Yasargil  
34-626-16 - 34-627-24



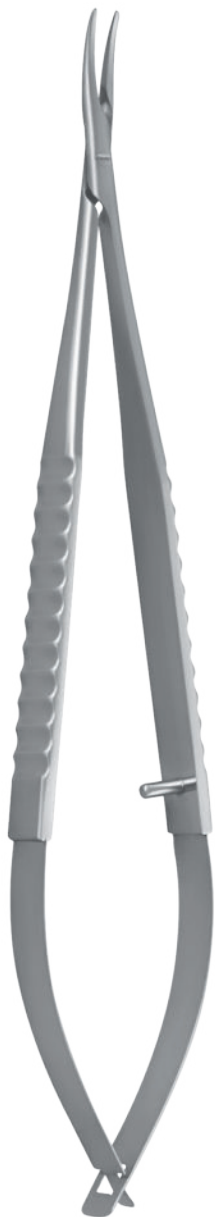







34-632-16 - 34-633-24





34-632-16	16 cm	
34-632-20	20 cm	
34-632-24	24 cm	

34-638-16	16 cm	
34-638-20	20 cm	
34-638-24	24 cm	



34-633-16	16 cm	
34-633-20	20 cm	
34-633-24	24 cm	

34-639-16	16 cm	
34-639-20	20 cm	
34-639-24	24 cm	



34-638-16 - 34-639-24



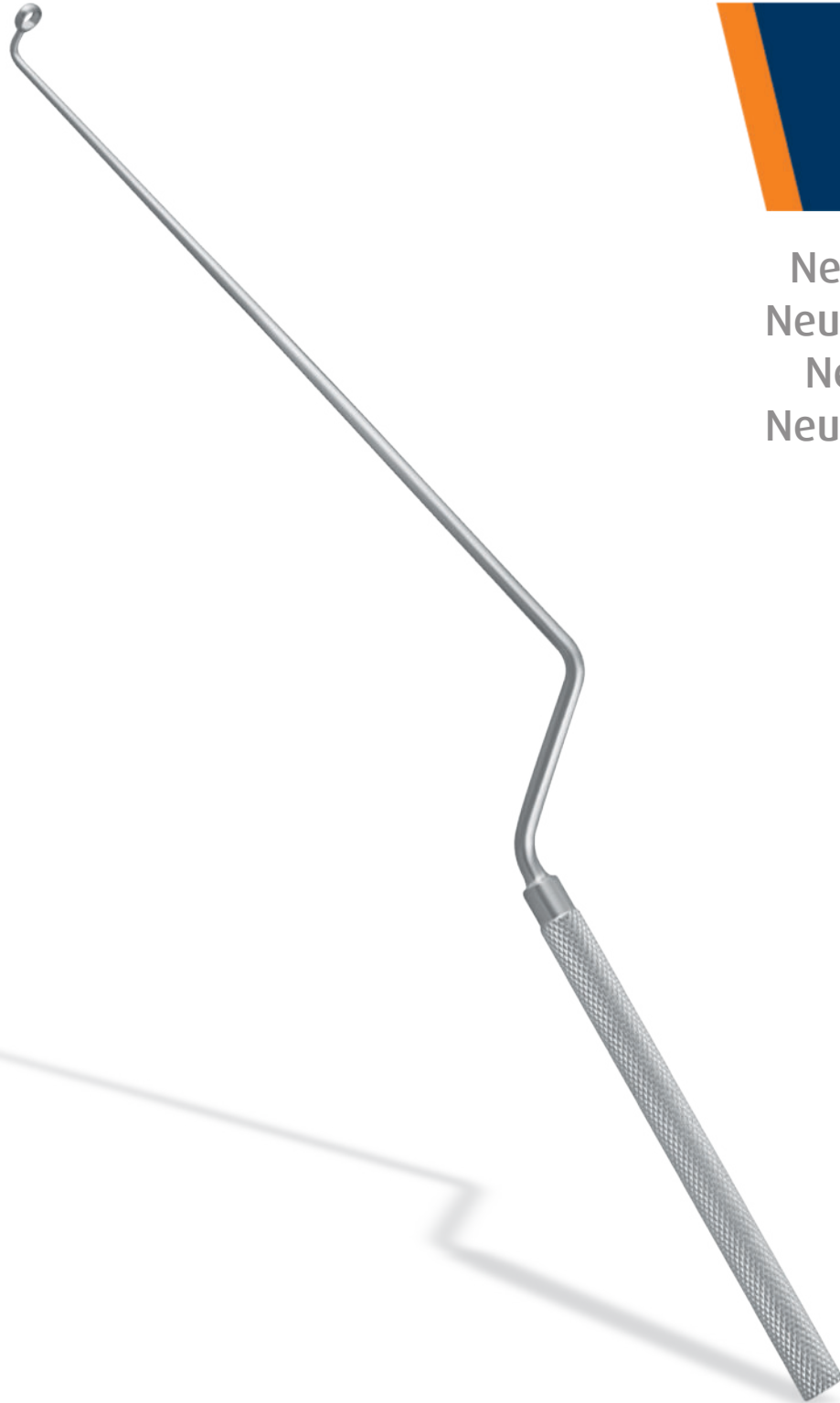

35

Neurosurgery  
Neurochirurgie  
Neurocirugía  
Neurochirurgie

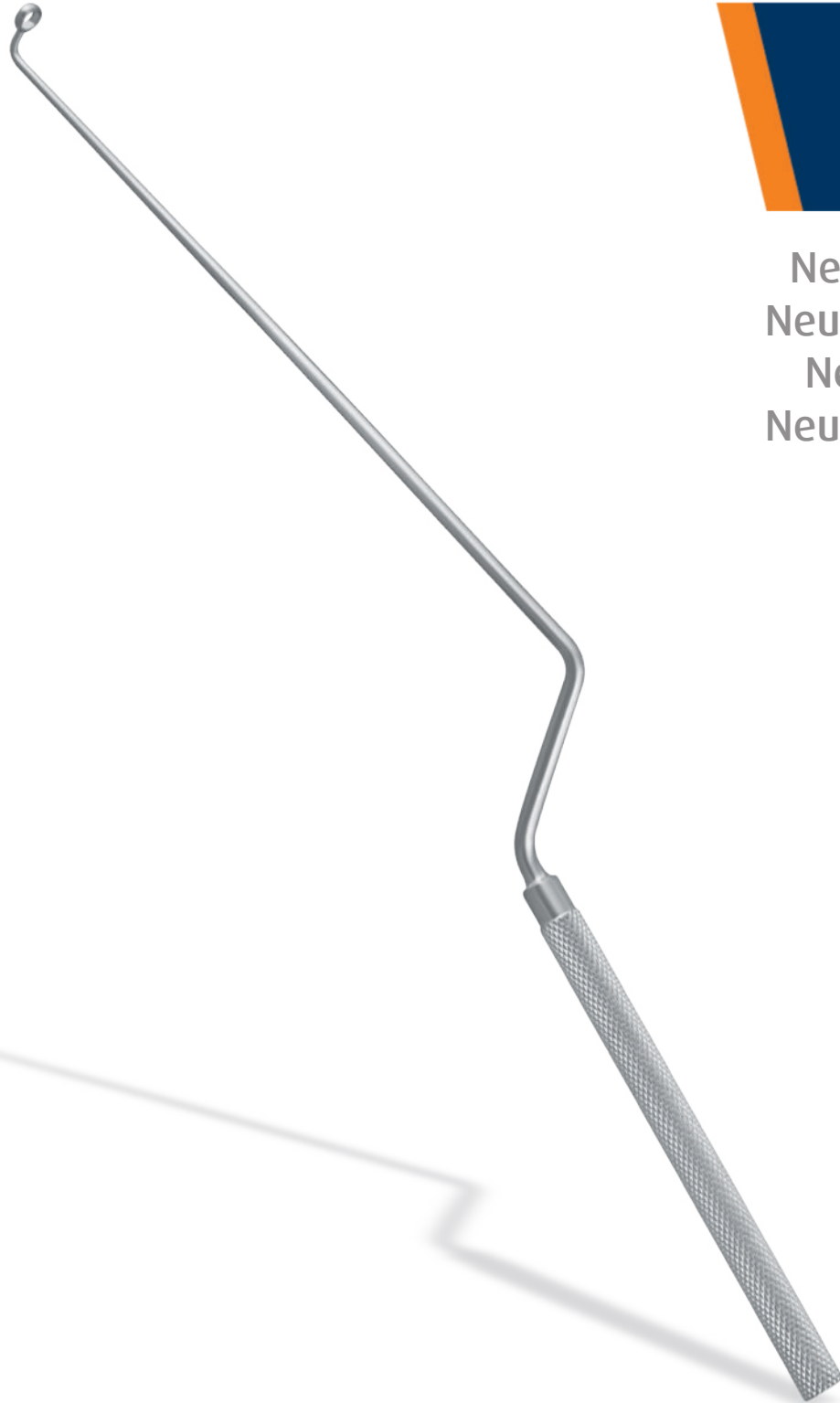

35

Neurosurgery  
Neurochirurgie  
Neurocirugía  
Neurochirurgie



1/1

35-100-13 II  
13.5 cm



35-100-15 II  
15.5 cm



Caspar  
35-100-18 II  
18 cm



35-100-20 II  
20 cm

35-100-13 - 35-100-20



Landolt  
35-110-21 - 35-116-21

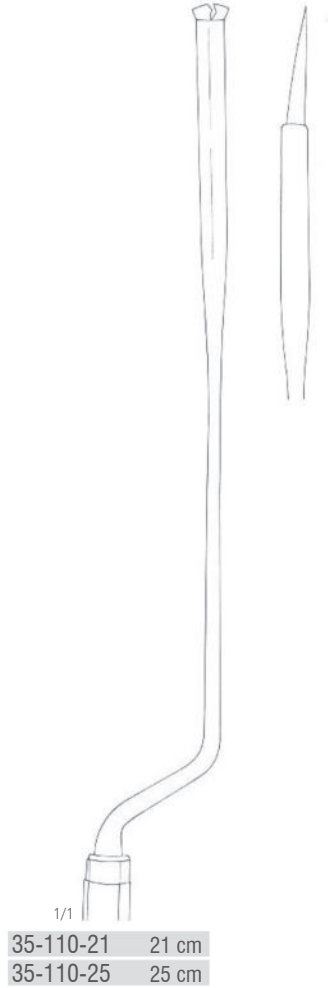

1/1  
35-110-21 21 cm  
35-110-25 25 cm

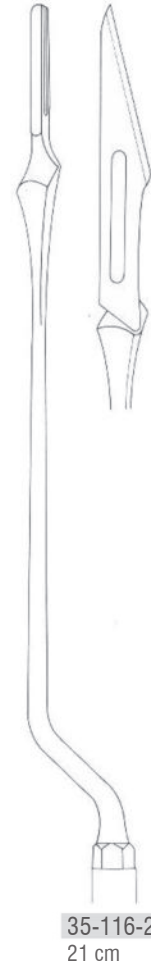

35-116-21  
21 cm

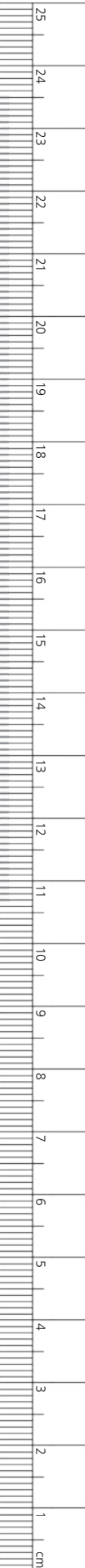



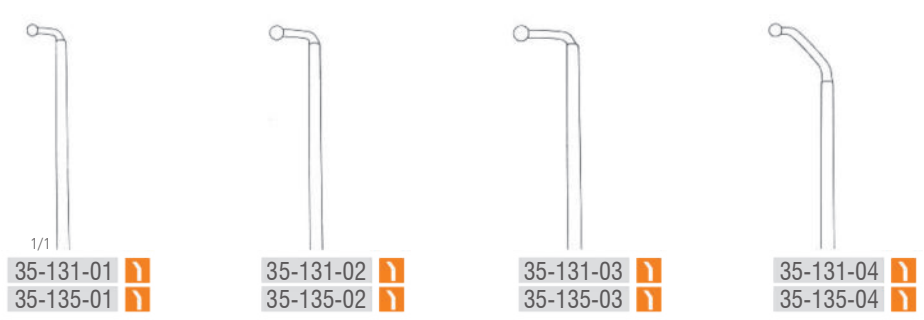









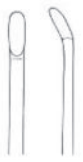
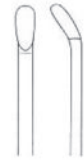









Exploration and Coagulation Hook  
Explorations- und Koagulations haken  
Gancho de exploracion y coagulacion  
Crochet d'exploration et de coagulation



35-131-01 - 35-135-04  
Non-insulated

Caspar  
35-131-01 - 35-135-04  
24.5 cm



			
35-151-10 20 cm 	35-151-15 20 cm 	35-151-20 20 cm 	35-151-25 20 cm 
35-155-10 23 cm 	35-155-15 23 cm 	35-155-20 23 cm 	35-155-25 23 cm 
1.0 mm	1.5 mm	2.0 mm	2.5 mm
			
35-151-30 20 cm 	35-151-35 20 cm 	35-151-40 20 cm 	35-151-50 20 cm 
35-155-30 23 cm 	35-155-35 23 cm 	35-155-40 23 cm 	35-155-50 23 cm 
3.0 mm	3.5 mm	4.0 mm	5.0 mm

Samii  
35-151-10 - 35-155-50

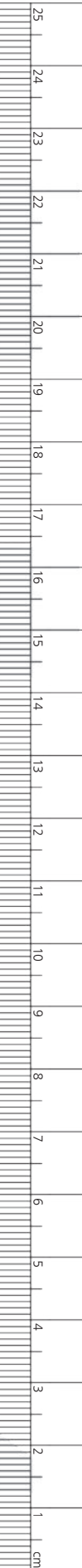

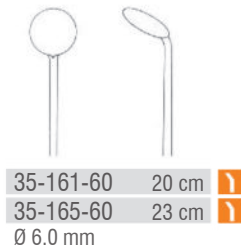
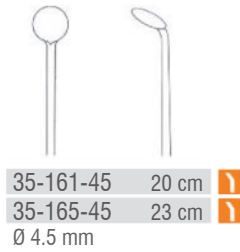
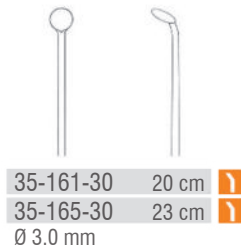
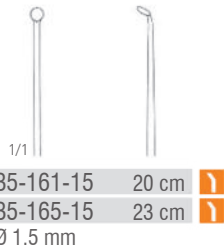

Samii  
 35-161-15 - 35-173-25



35-201-10 - 35-219-18



1/1

Caspar

35-201-10

20 cm  
1.0 mm



Caspar

35-201-45

23 cm  
4.5 mm



1/1

35-207-01

23 cm



35-207-02

23 cm



35-207-03

23 cm



1/1

35-213-01

18.5 cm  
2.0 mm



35-213-02

21.5 cm  
3.0 mm



Yasargil

35-219-18

18.5 cm

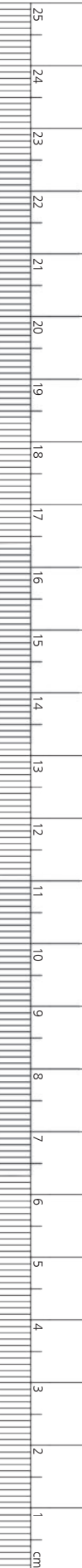





1/1  
Caspar  
35-231-01  
23 cm  
2.0 mm



Caspar  
35-231-02  
23 cm  
4.5 mm



1/1  
Caspar  
35-237-01  
21 cm  
1.0 mm



Caspar  
35-237-02  
21 cm  
1.0 mm



1/1  
35-243-01  
23 cm



35-243-02  
23 cm

35-231-02 - 35-243-02

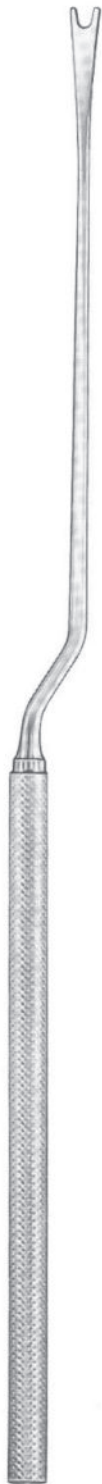

35-260-18 - 35-264-28



Okonek - Yasargil  
 35-271-03 - 35-271-08

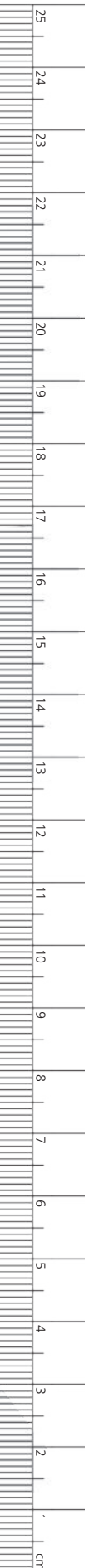

Vessel spreader



Vessel dilator

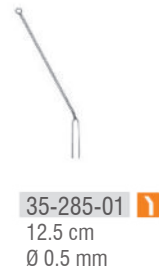

Vessel dilator



Vessel dilator



Probe with ball tip



Vessel probe



35-281-16 - 35-297-18

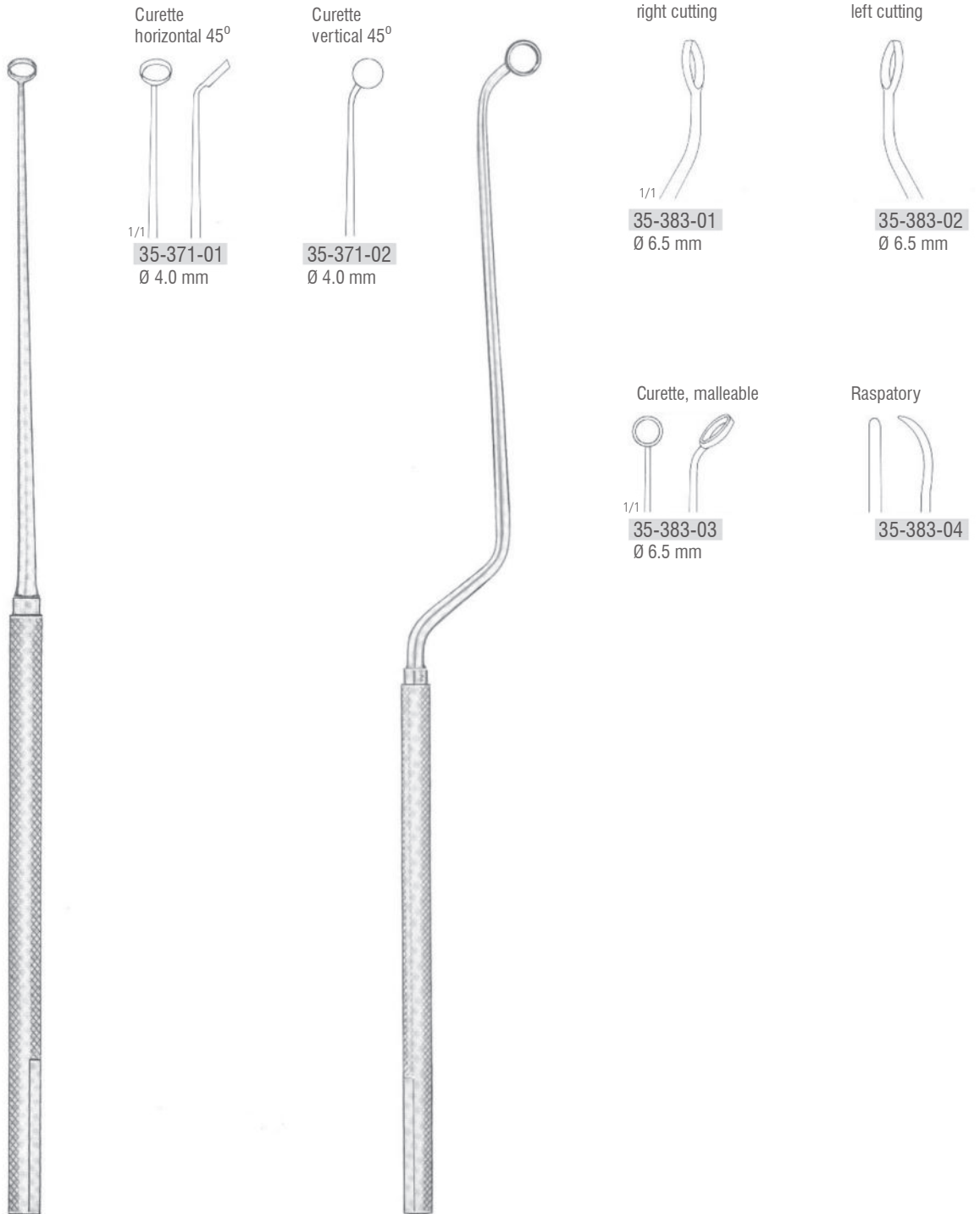

Curette  
horizontal 45°  
 1/1  
 35-371-01  
 Ø 4.0 mm

Curette  
vertical 45°  
 35-371-02  
 Ø 4.0 mm

Curette, malleable  
right cutting  
 1/1  
 35-383-01  
 Ø 6.5 mm

Curette, malleable  
left cutting  
 35-383-02  
 Ø 6.5 mm

Curette, malleable  
 1/1  
 35-383-03  
 Ø 6.5 mm

Raspatory  
 35-383-04

Ray  
 35-371-01 - 35-371-02  
 18 cm

Nicola  
 35-383-01 - 35-384-04  
 21.5 cm

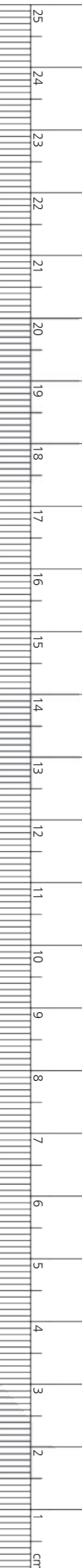



35-411-01 - 35-429-24  
24.5 cm

Enucleator, blunt



Hardy  
35-411-01 Right  
35-411-02 Left

Enucleator, sharp



Hardy  
35-413-01 Right  
35-413-02 Left

Enucleator, blunt



Hardy  
35-417-01 Right  
35-417-02 Left

Enucleator, sharp



Hardy  
35-419-01 Right  
35-419-02 Left



Hardy - Fahlbusch  
35-423-01



Hardy - Fahlbusch  
35-423-02

Implant fork



Hardy  
35-429-24



35-441-01 - 35-455-26  
26 cm

Enucleator, blunt, malleable



1/1  
Landolt  
35-441-01 Right  
35-441-02 Left

Enucleator, sharp, malleable



Landolt  
35-443-01 Right  
35-443-02 Left

Curette, malleable

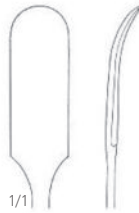

1/1  
Landolt  
35-447-01

Scoop, malleable

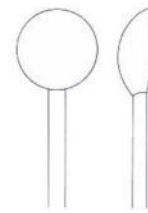

Landolt  
35-447-02

Blunt hook, malleable



1/1  
Landolt  
35-451-26

Fork spatula, rigid



Hosobuchi  
35-455-26

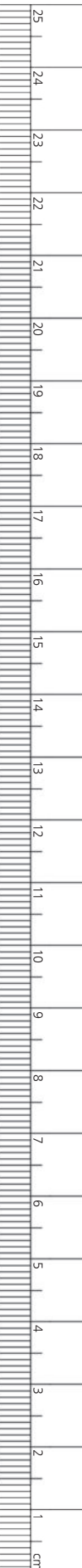



Curette, malleable



Haedy  
35-481-04 - 35-481-06  
26 cm



35-501-01 - 35-519-26  
26 cm

Scoop, malleable



1/1  
Fahlbusch  
35-501-01

Curette, malleable

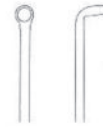

Fahlbusch  
35-501-02  
Ø 2.5 mm

Raspatory, rigid



1/1  
Landolt - Reulen  
35-507-01  
Ø 2.2 mm

Raspatory, rigid



Landolt - Reulen  
35-507-02  
Ø 3.2 mm

Curette, rigid

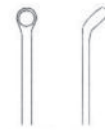

Landolt - Reulen  
35-507-03  
Ø 2.5 mm

Blunt hook, rigid



1/1  
Landolt - Reulen  
35-513-26  
1.7 mm

Dissector, rigid



Landolt - Reulen  
35-519-26  
2.0 mm

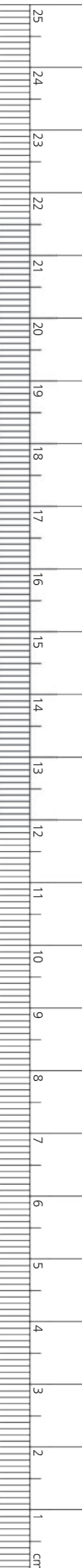



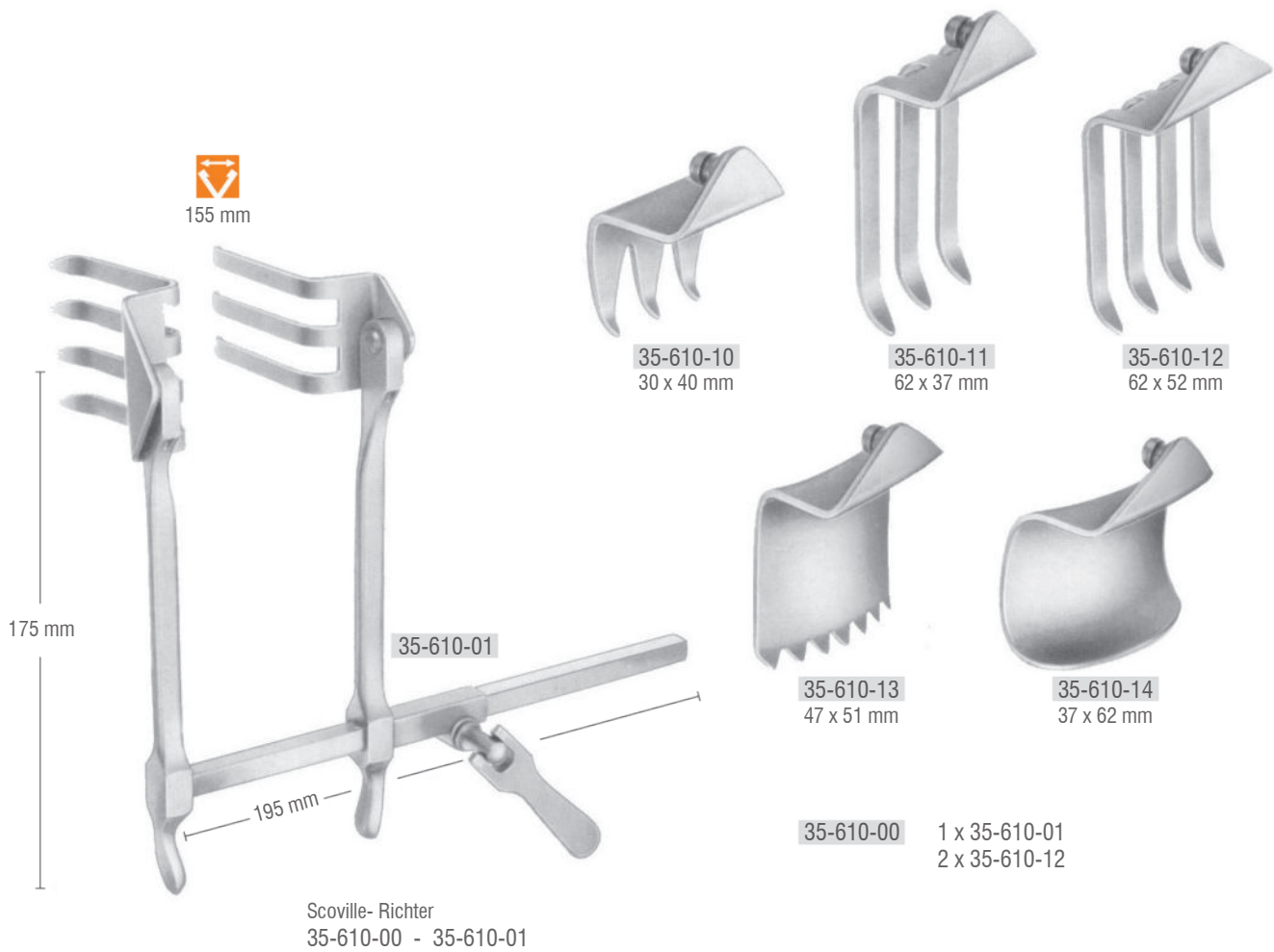



35-640-10  
38 mm



35-640-21  
37 x 22 mm



35-640-22  
43 x 22 mm



35-640-23  
47 x 22 mm



35-640-24  
52 x 22 mm



35-640-25  
57 x 22 mm



145 mm

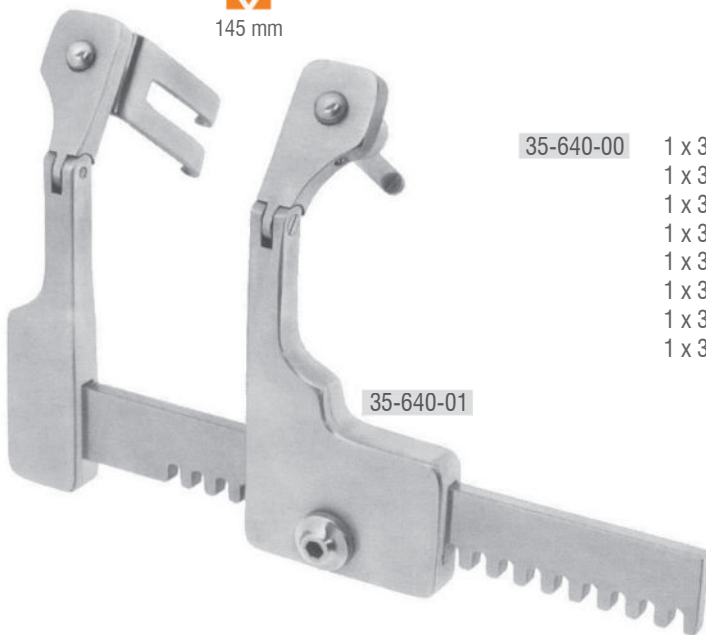

35-640-01

- 35-640-00
- 1 x 35-640-01
  - 1 x 35-640-10
  - 1 x 35-640-21
  - 1 x 35-640-22
  - 1 x 35-640-23
  - 1 x 35-640-24
  - 1 x 35-640-25
  - 1 x 35-640-50

Caspar  
35-640-00 - 35-640-01



35-640-50

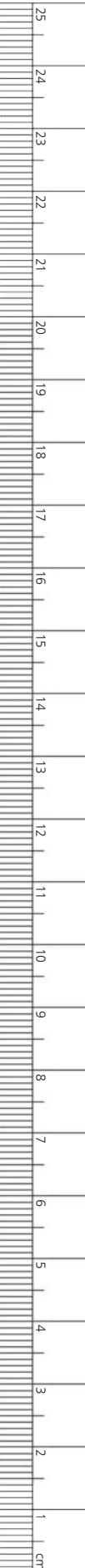



35-640-10	38 mm
35-640-11	58 mm

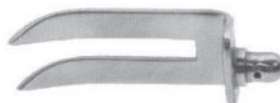

35-640-20	32 x 22 mm
35-640-21	37 x 22 mm
35-640-22	43 x 22 mm
35-640-23	47 x 22 mm
35-640-24	52 x 22 mm
35-640-25	57 x 22 mm
35-640-26	62 x 22 mm
35-640-27	67 x 22 mm



35-640-30	32 x 37 mm
35-640-31	37 x 37 mm
35-640-32	43 x 37 mm
35-640-33	47 x 37 mm
35-640-34	52 x 37 mm
35-640-35	57 x 37 mm
35-640-36	62 x 37 mm
35-640-37	67 x 37 mm



35-640-40	32 x 52 mm
35-640-41	37 x 52 mm
35-640-42	43 x 52 mm
35-640-43	47 x 52 mm
35-640-44	52 x 52 mm
35-640-45	57 x 52 mm
35-640-46	62 x 52 mm
35-640-77	67 x 52 mm



35-648-11	11.5 cm
-----------	---------

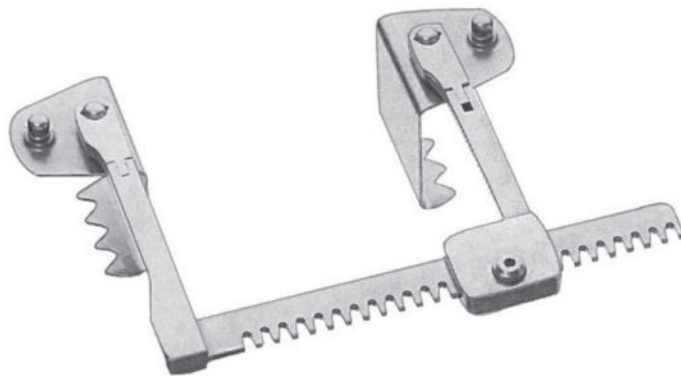

Caspar  
35-660-01



Handle  
35-660-06

Blades

35-660-10	50 x 44 mm
35-660-11	50 x 54 mm
35-660-12	50 x 74 mm
35-660-13	50 x 89 mm



35-660-00 1 x 35-660-01  
 2 x 35-660-06  
 2 x 35-660-10  
 1 x 35-660-50

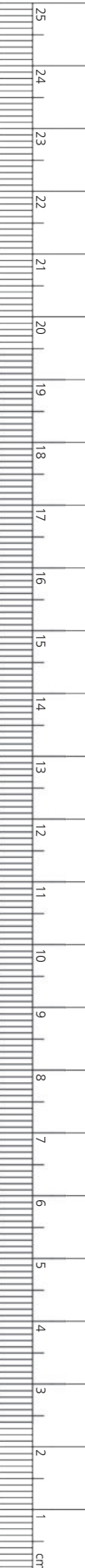



85 mm



- 35-670-00 1 x 35-670-01  
 1 x 35-710-13  
 1 x 35-710-14  
 1 x 35-710-15  
 1 x 35-710-16  
 1 x 35-710-17



35-710-13  
 45 x 23 mm



35-710-14  
 50 x 23 mm



35-710-15  
 55 x 23 mm



35-710-16  
 60 x 23 mm



35-710-17  
 65 x 23 mm

Caspar  
 35-670-00 - 35-670-01



90 mm



- 35-680-00 1 x 35-680-01  
 1 x 35-710-13  
 1 x 35-710-14  
 1 x 35-710-15  
 1 x 35-710-16  
 1 x 35-710-17

Caspar  
 35-680-00 - 35-680-01



35-710-20  
40 x 23 mm



35-710-30  
40 x 23 mm



35-710-21  
45 x 23 mm



35-710-31  
45 x 23 mm



35-710-22  
50 x 23 mm



35-710-32  
50 x 23 mm



35-710-23  
55 x 23 mm



35-710-33  
55 x 23 mm



35-710-24  
60 x 23 mm



35-710-34  
60 x 23 mm



90 mm



35-700-01

Caspar  
35-700-00 - 35-700-01

- 35-710-00
- 1 x 35-700-01
  - 1 x 35-710-20
  - 1 x 35-710-21
  - 1 x 35-710-22
  - 1 x 35-710-23
  - 1 x 35-710-24
  - 1 x 35-710-30
  - 1 x 35-710-31
  - 1 x 35-710-32
  - 1 x 35-710-33
  - 1 x 35-710-34

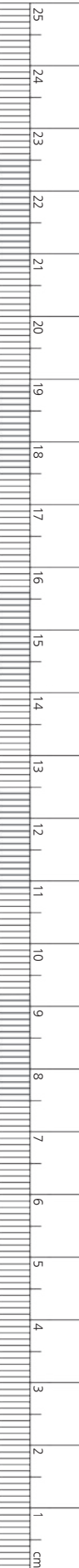



35-710-10	30 x 23 mm
35-710-11	35 x 23 mm
35-710-12	40 x 23 mm
35-710-13	45 x 23 mm
35-710-14	50 x 23 mm
35-710-15	55 x 23 mm
35-710-16	60 x 23 mm
35-710-17	65 x 23 mm
35-710-18	70 x 23 mm
35-710-19	75 x 23 mm



35-710-20	40 x 23 mm
35-710-21	45 x 23 mm
35-710-22	50 x 23 mm
35-710-23	55 x 23 mm
35-710-24	60 x 23 mm



35-710-30	40 x 23 mm
35-710-31	45 x 23 mm
35-710-32	50 x 23 mm
35-710-33	55 x 23 mm
35-710-34	60 x 23 mm



35-710-40	50 x 25 mm
35-710-41	60 x 25 mm



35-710-50	40 x 25 mm
35-710-51	45 x 25 mm
35-710-52	50 x 25 mm
35-710-53	55 x 25 mm
35-710-54	60 x 25 mm



35-710-60	40 x 25 mm
35-710-61	45 x 25 mm
35-710-62	50 x 25 mm
35-710-63	55 x 25 mm
35-710-64	60 x 25 mm



35-710-70	25 x 24 mm
35-710-71	30 x 24 mm
35-710-72	35 x 24 mm
35-710-73	40 x 24 mm
35-710-74	45 x 24 mm
35-710-75	50 x 24 mm
35-710-76	55 x 24 mm
35-710-77	60 x 24 mm
35-710-78	65 x 24 mm
35-710-79	70 x 24 mm



35-710-80	25 x 24 mm
35-710-81	30 x 24 mm
35-710-82	35 x 24 mm
35-710-83	40 x 24 mm
35-710-84	45 x 24 mm
35-710-85	50 x 24 mm
35-710-86	55 x 24 mm
35-710-87	60 x 24 mm
35-710-88	65 x 24 mm
35-710-89	70 x 24 mm



35-730-10	35 mm
35-730-11	40 mm
35-730-12	45 mm
35-730-13	50 mm
35-730-14	55 mm
35-730-15	60 mm
35-730-16	65 mm
35-730-17	75 mm
35-730-18	85 mm



35-730-20	40 mm
35-730-21	45 mm
35-730-22	50 mm
35-730-23	55 mm
35-730-24	60 mm
35-730-25	65 mm
35-730-26	70 mm



60 mm



35-780-01

Caspar  
 35-780-00 - 35-780-01

35-730-00	1 x 35-730-01
	1 x 35-730-11
	1 x 35-730-12
	1 x 35-730-13
	1 x 35-730-14
	1 x 35-730-15
	1 x 35-730-16

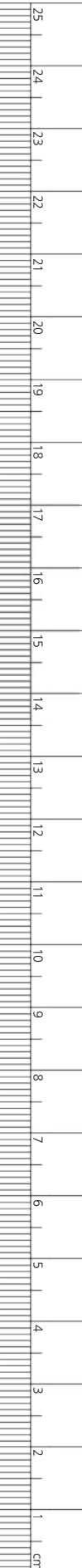



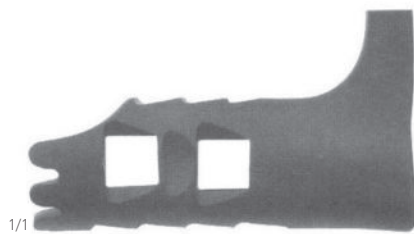

35-736-01  
40 x 18 mm



35-736-02  
45 x 18 mm

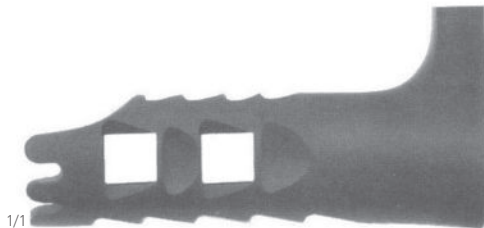

35-736-03  
50 x 18 mm

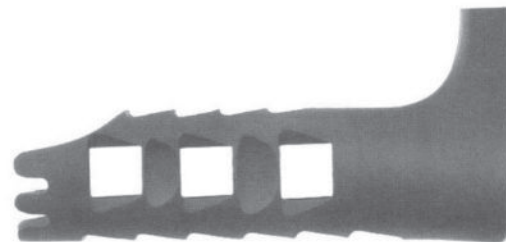

35-736-04  
55 x 18 mm

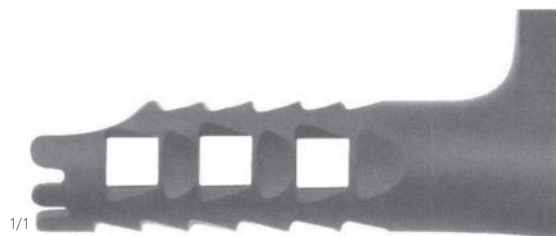

35-736-05 60 x 18 mm  
 35-736-06 65 x 18 mm  
 35-736-07 75 x 18 mm  
 35-736-08 85 x 18 mm



Caspar  
 35-786-01 - 35-786-08



Cushing - Landolt  
 35-750-01 70 x 15 mm  
 35-750-02 90 x 15 mm  
 35-750-03 110 x 15 mm



Papavero - Caspar  
 35-754-01 80 x 11 mm  
 35-754-02 90 x 13 mm  
 35-754-03 100 x 15 mm



Caspar  
 35-758-01 45 mm  
 35-758-02 50 mm  
 35-758-03 55 mm  
 35-758-04 60 mm  
 35-758-05 65 mm

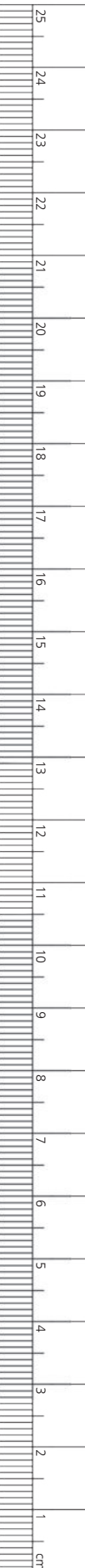

Spreader for specula



Landolt  
 35-800-21  
 21 cm



Caspar  
 35-810-00 - 35-810-01



35-810-10	40 mm
35-810-11	45 mm
35-810-12	50 mm
35-810-13	55 mm
35-810-14	60 mm
35-810-15	65 mm
35-810-16	70 mm

35-810-10	1 x 35-810-01
	1 x 35-810-10
	1 x 35-810-11
	1 x 35-810-12
	1 x 35-810-13
	1 x 35-810-14
	1 x 35-810-15
	1 x 35-810-16

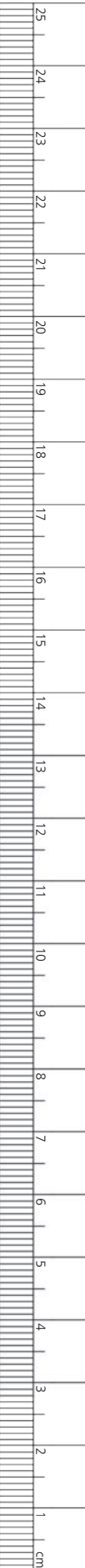

35-900-01  
 Distractor only, right

35-900-02  
 Distractor only, left



Caspar  
 35-900-01 - 35-900-02

35-910-01  
 Drill guide right for 35-900-01

35-910-02  
 Drill guide left for 35-900-02



35-910-01 - 35-910-02

Screw driver for distractor screws

Twist drill Ø 1.7 mm for  
 distractor screws



35-914-14  
 14.5 cm

35-918-20  
 20 cm