

# 18

Intestines, Stomach, Rectum  
Darm, Magen, Rektum  
Intestinos, Estómago, Recto  
Intestins, Estomac, Rectum

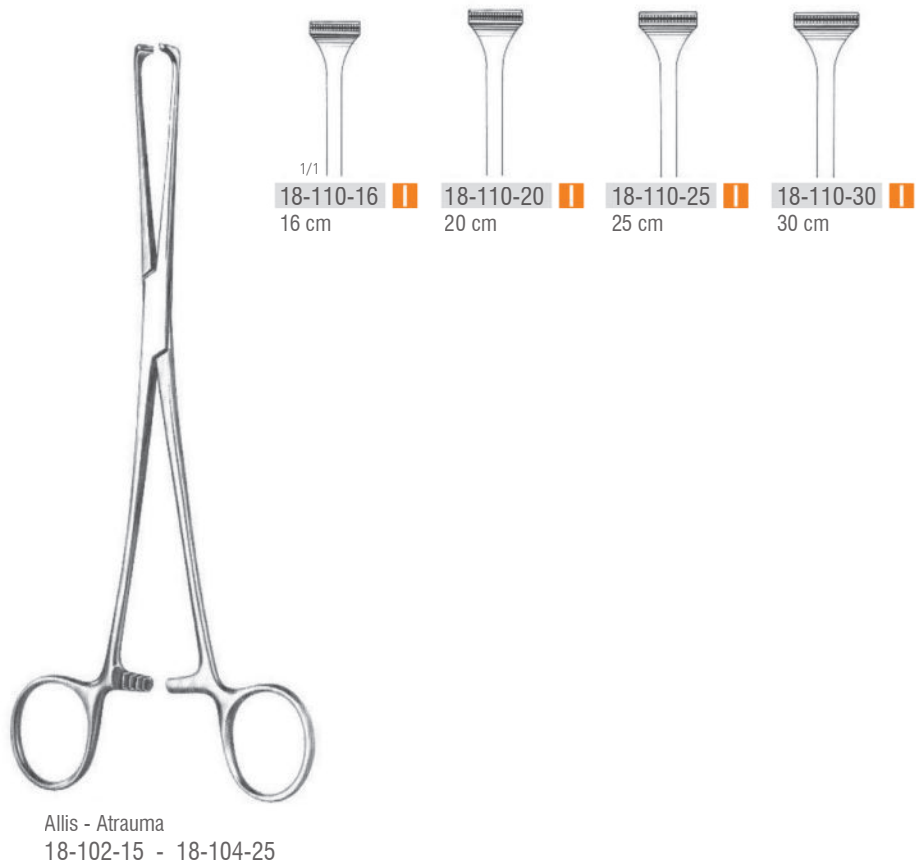

**Tissue and Organ Holding Forceps**  
**Haltezange für Gewebe und Organe**  
**Pinzas de sujeción de tejidos y órganos**  
**Forceps tenant des tissus et des organes**





Allis - Adair  
 18-120-15   
 15.5 cm



Boys - Allis  
 18-124-15   
 15 cm

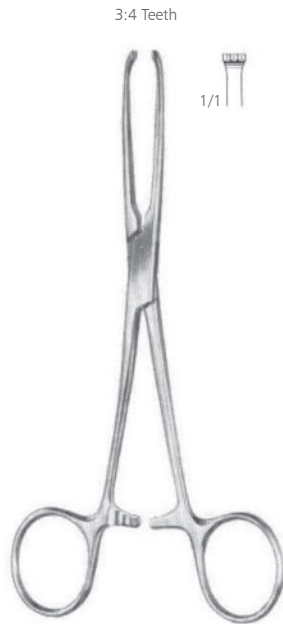

Judd - Allis  
 18-128-15 15 cm   
 18-128-19 19 cm

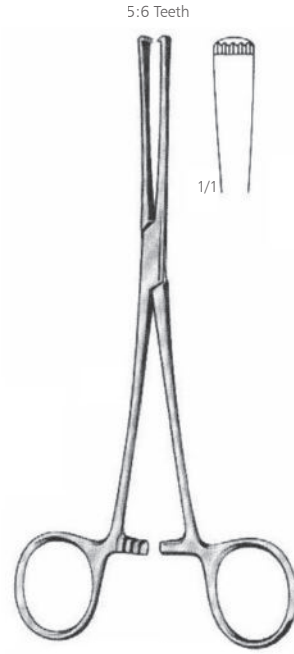

Lockwood - Allis  
 18-130-16 16 cm   
 18-130-20 20 cm



Thoms - Allis  
 18-134-30   
 20 cm



Allis  
 18-138-30   
 20 cm

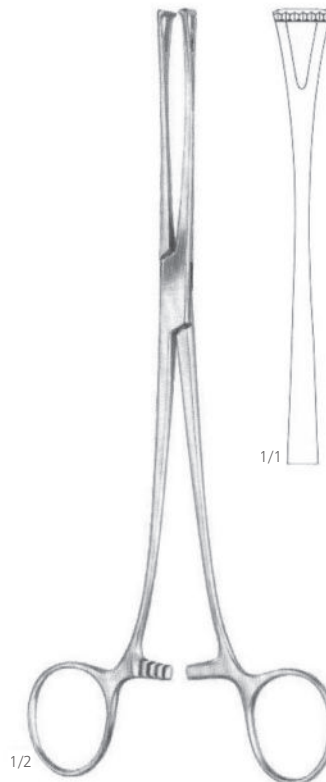

Lockwood  
 18-142-20   
 20 cm

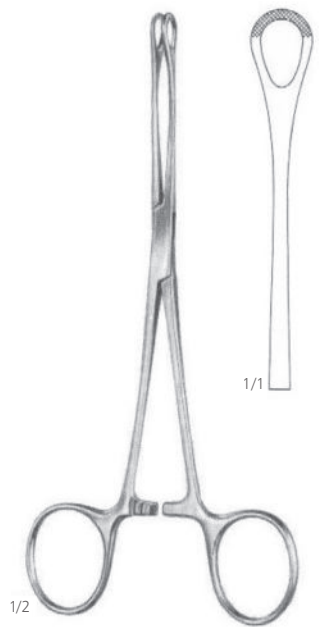

Williams  
 18-146-16   
 16 cm

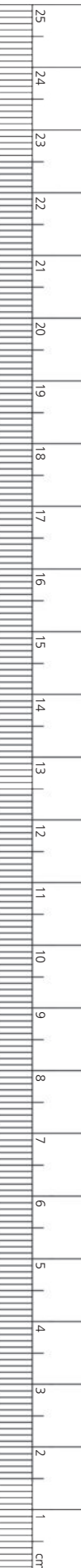



1/1  
 18-170-16 II  
 16 cm

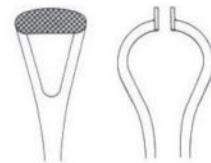

18-170-20  
 20 cm



1/1

1/2

Duval  
 18-176-20 II  
 20 cm





Babcock  
18-190-16 - 18-190-24



18-190-16 ||  
16 cm



18-190-18 ||  
18 cm



18-190-20 ||  
20 cm

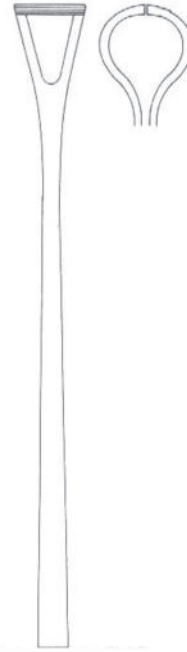

18-190-24 ||  
24 cm

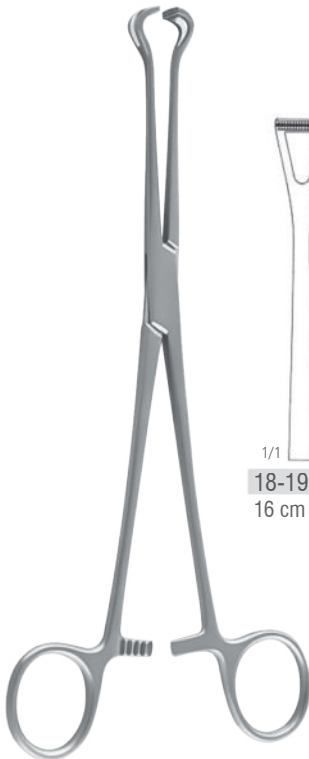

Babcock - Atrauma  
18-194-16 - 18-194-20



18-194-16 ||  
16 cm

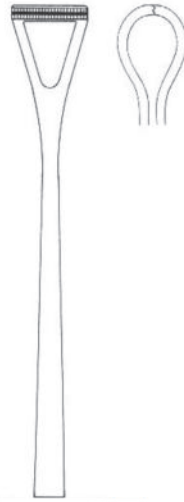

18-194-20 ||  
20 cm



Duval  
18-200-18 - 18-202-23



18-200-18 ||  
18 cm

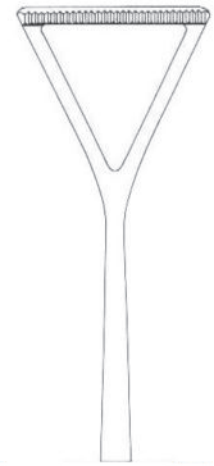

18-202-20 ||  
20 cm

18-200-20 ||  
20 cm

18-202-23 ||  
23 cm

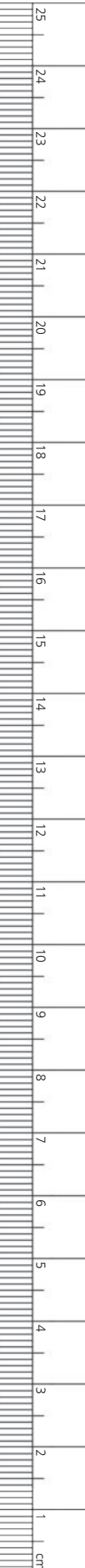

**Intestinal Clamp Forceps**  
**Darmklemmzangen**  
**Pinzas de pinza intestinal**  
**Forceps de pince intestinale**



18-210-13 II 18-211-13 II

Baby - Kocher  
 18-210-13 - 18-211-13  
 13 cm



18-230-16 II  
 16 cm

18-231-16 II  
 16 cm

18-230-18 II  
 18 cm

18-231-18 II  
 18 cm

18-236-21 II  
 21 cm

18-237-21 II  
 21 cm

18-236-23 II  
 23 cm

18-237-23 II  
 23 cm

Baby - Doyen  
 18-230-16 - 18-231-19

Doyen  
 18-236-21 - 18-237-23

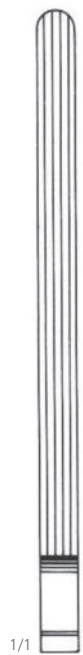

18-240-21   
21 cm

18-240-23   
23 cm

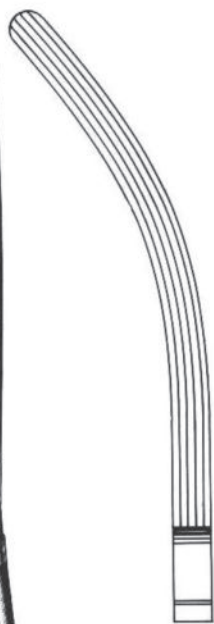

18-241-21   
21 cm

18-241-23   
23 cm



Mayo - Robson  
18-240-21 - 18-241-23



18-246-25 

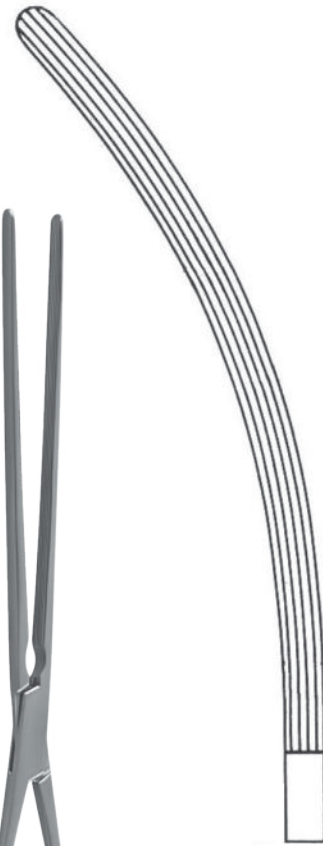

18-247-25 

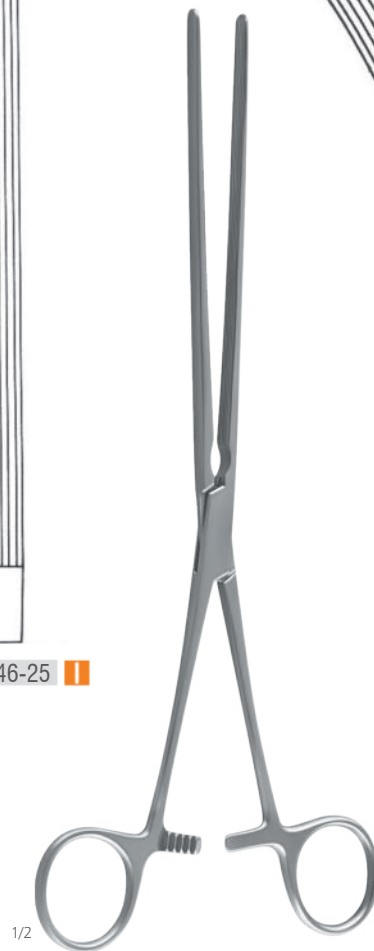

Mayo - Robson  
18-246-25 - 18-247-25  
25 cm

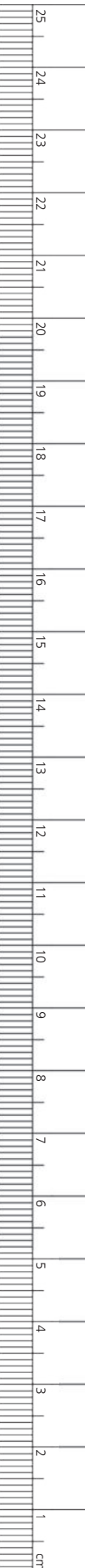

**Intestinal Clamp Forceps**  
**Darmklemmzangen**  
**Pinzas de pinza intestinal**  
**Forceps de pince intestinale**



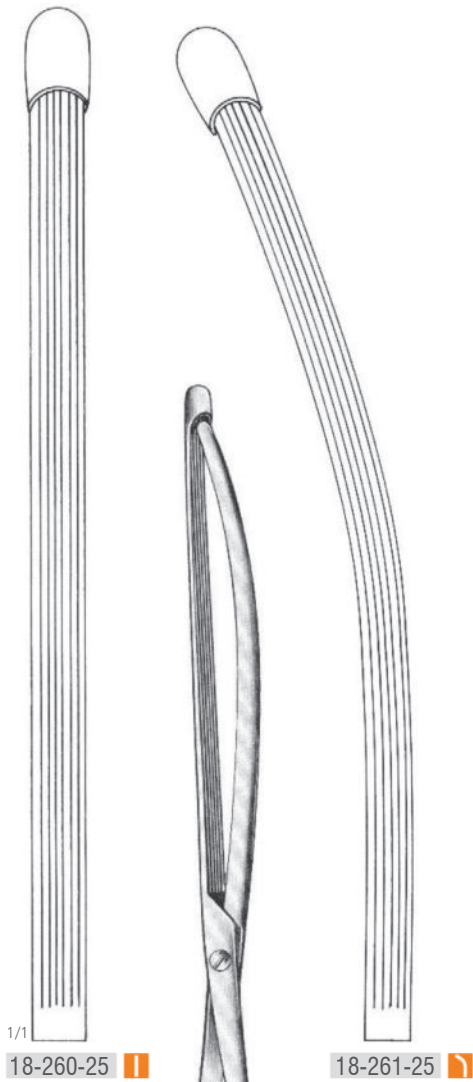

1/2  
Nussbaum  
18-260-25 - 18-261-25  
25 cm

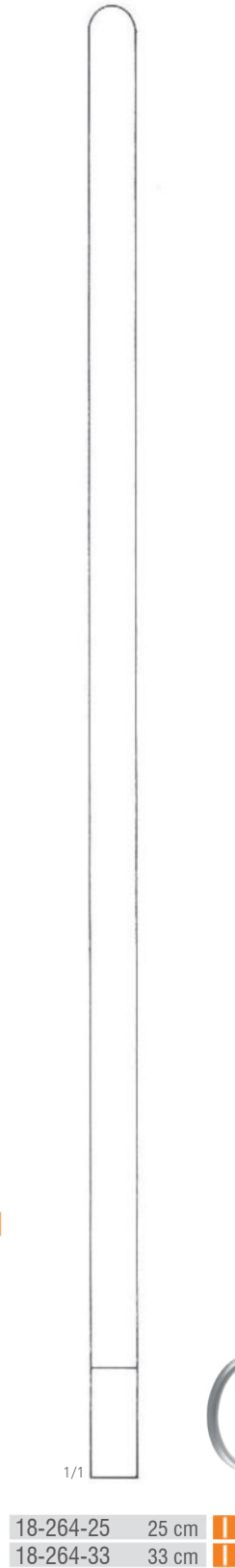

Scudder

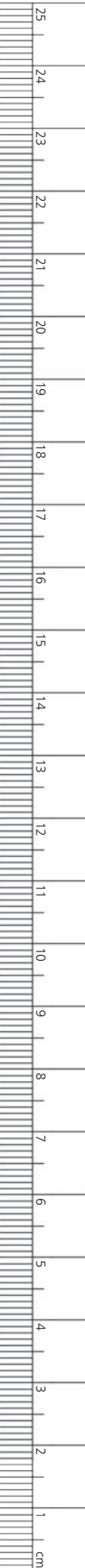
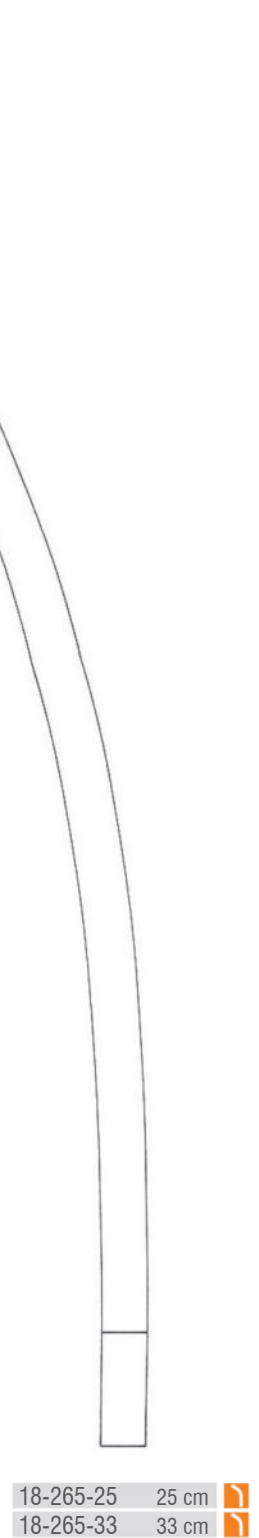

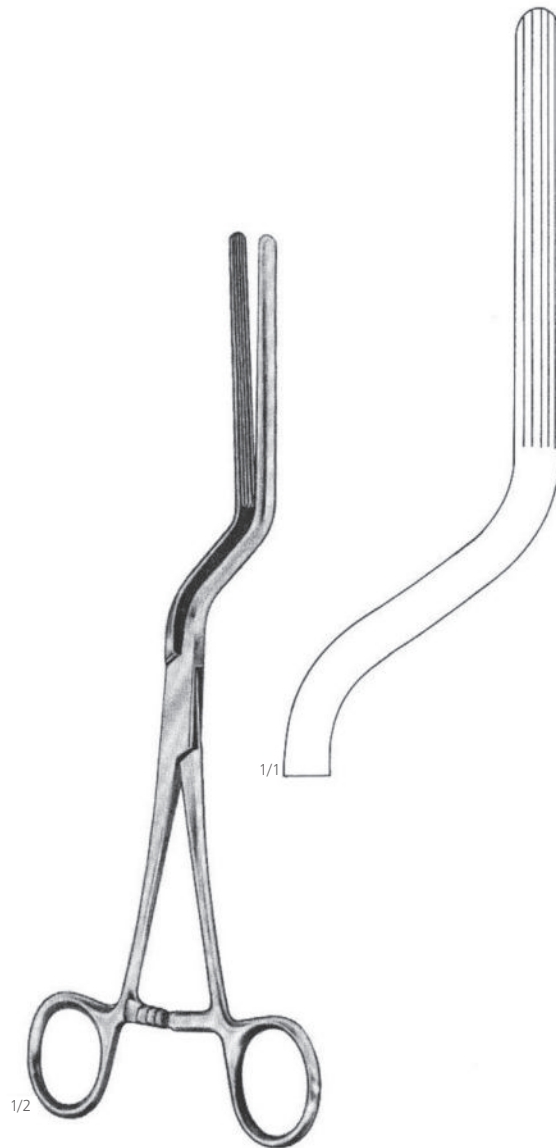

Brunner  
18-280-24   
24 cm





**Atrauma Intestinal and Stomach Clamp Forceps**  
**Atrauma Darm- und Magenklemmzangen**  
**Pinzas de abrazadera de estómago e intestinales de Atrauma**  
**Pinces à pinces intestinales et gastriques Atrauma**



Doyen - Atrauma  
 18-370-13 - 18-370-23

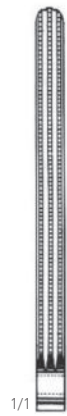

18-370-13 13 cm



18-370-16 16 cm



18-370-18 18 cm



18-370-21 21 cm



18-370-23 23 cm



Doyen - Atrauma  
 18-371-13 - 18-371-23



18-371-13 13 cm



18-371-16 16 cm



18-371-18 18 cm



18-371-21 21 cm

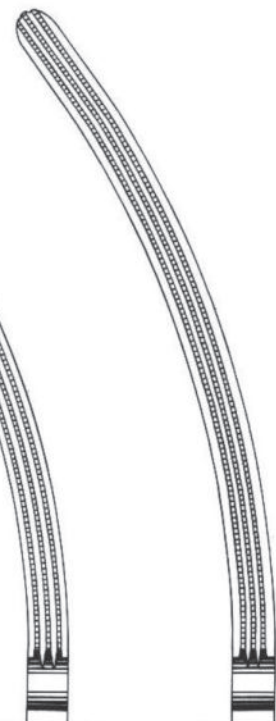

18-371-23 23 cm

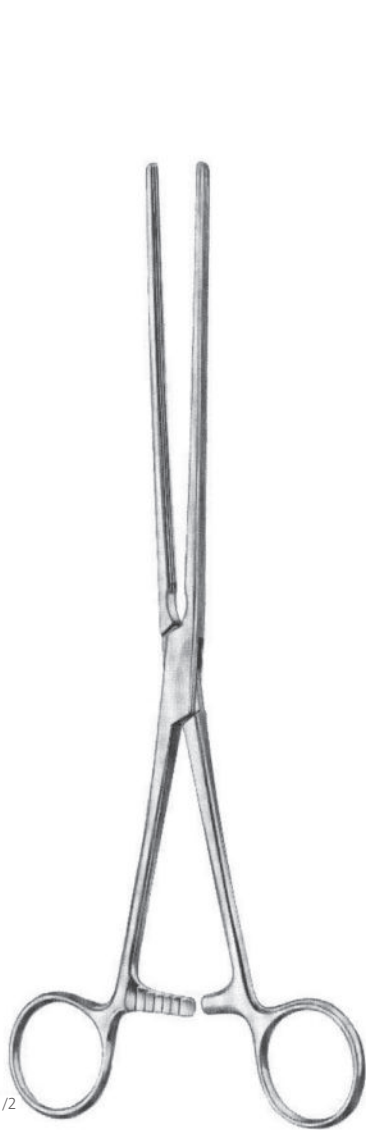

Mayo - Robson - Atrauma  
 18-380-25 ■  
 25 cm

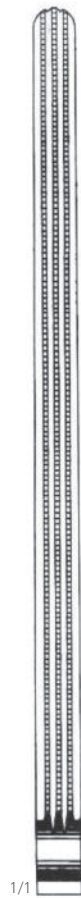

Mayo - Robson - Atrauma  
 18-381-25 ■  
 25 cm

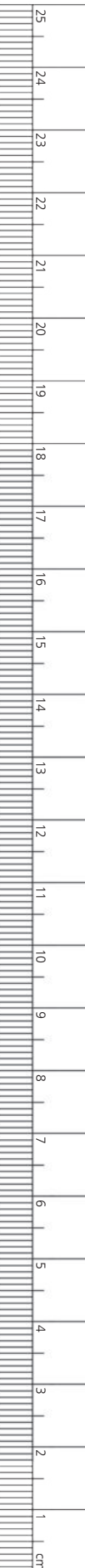
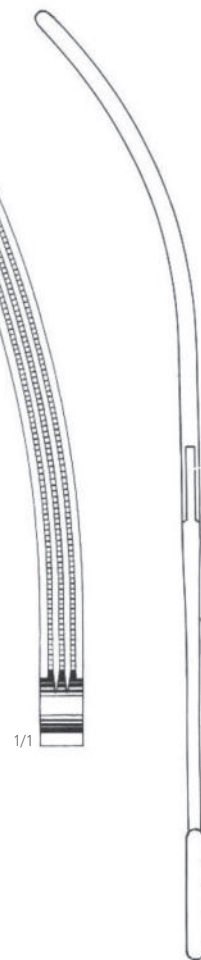

**Atrauma Intestinal and Stomach Clamp Forceps**  
**Atrauma Darm- und Magenklemmzangen**  
**Pinzas de abrazadera de estómago e intestinales de Atrauma**  
**Pinces à pincers intestinales et gastriques Atrauma**



Kocher - Atrauma  
 18-386-22 - 18-386-28

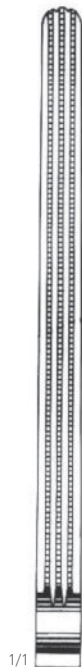

1/1  
 18-386-22 II  
 22 cm



18-386-25 II  
 25 cm

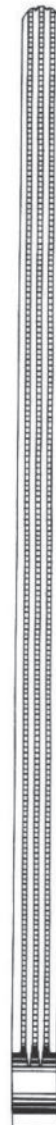

18-386-28 II  
 28 cm

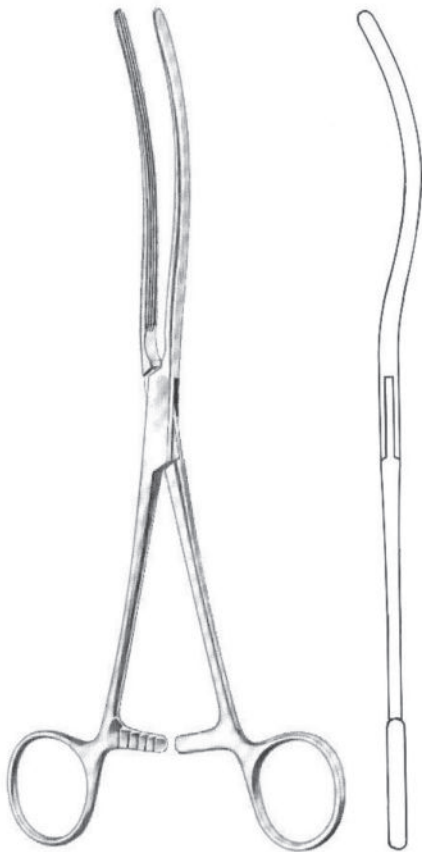

Kocher - Atrauma  
 18-387-22 - 18-387-28

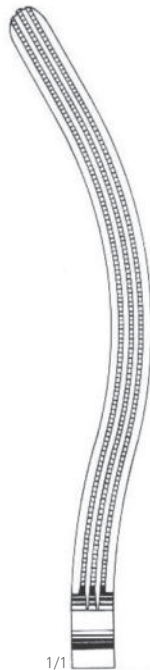

18-387-22  
 22 cm



18-387-25  
 25 cm



18-387-28  
 28 cm

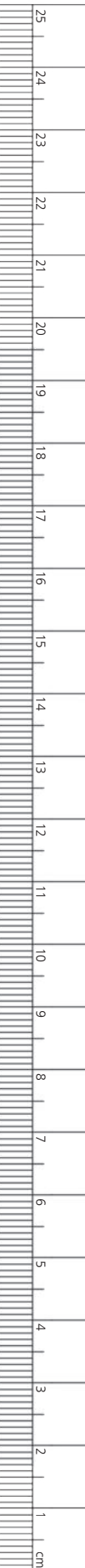

Atrauma Intestinal and Stomach Clamp Forceps  
 Atrauma Darm- und Magenklemmzangen  
 Pinzas de abrazadera de estómago e intestinales de Atrauma  
 Pincès à pincès intestinales et gastriques Atrauma

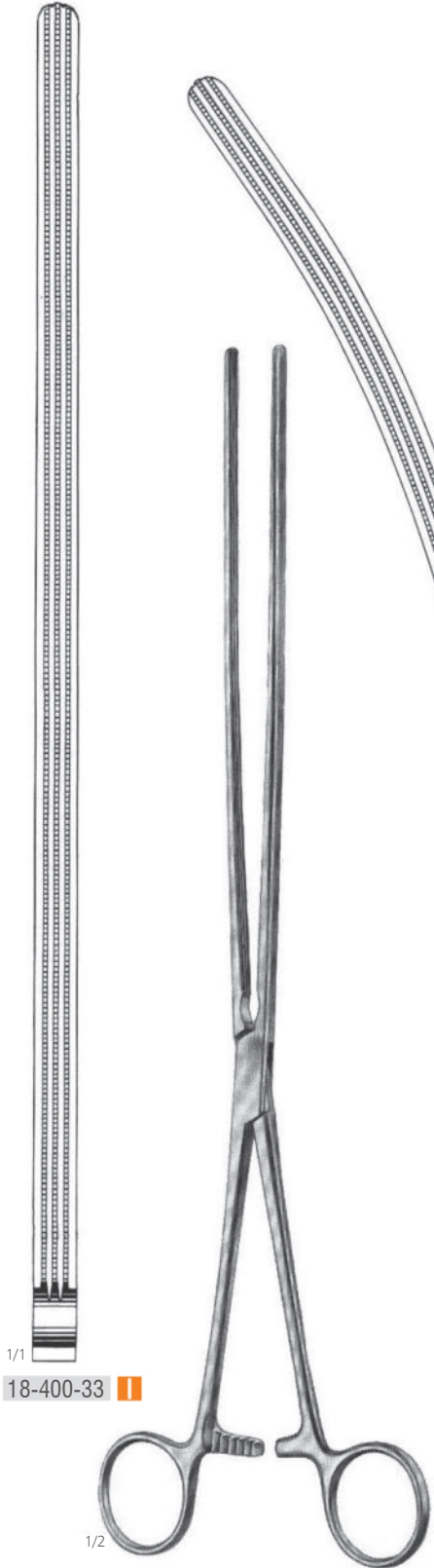

18-400-33 II

1/2

Scudder - Atrauma  
 18-400-33 - 18-401-33  
 33 cm



18-401-33 I



1/2

Brunner - Atrauma  
 18-410-24 I  
 24 cm







Veidenheimer  
 18-435-23   
 23 cm

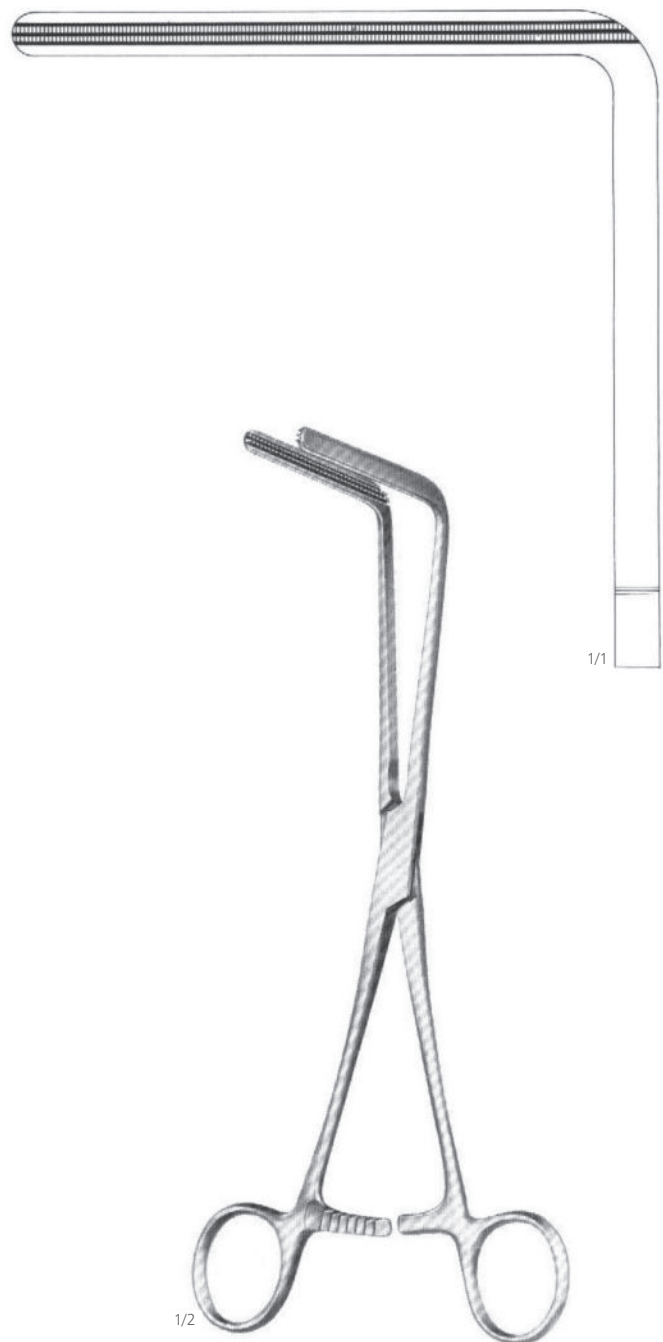

Fehland  
 18-437-24   
 24 cm





**Intestinal and Stomach Clamps (Crushing Clamps)**

Darm- und Magenquetschklemmen

Pinzas-clamps intestinales y estomacales

Pinces intestinales et abdominales

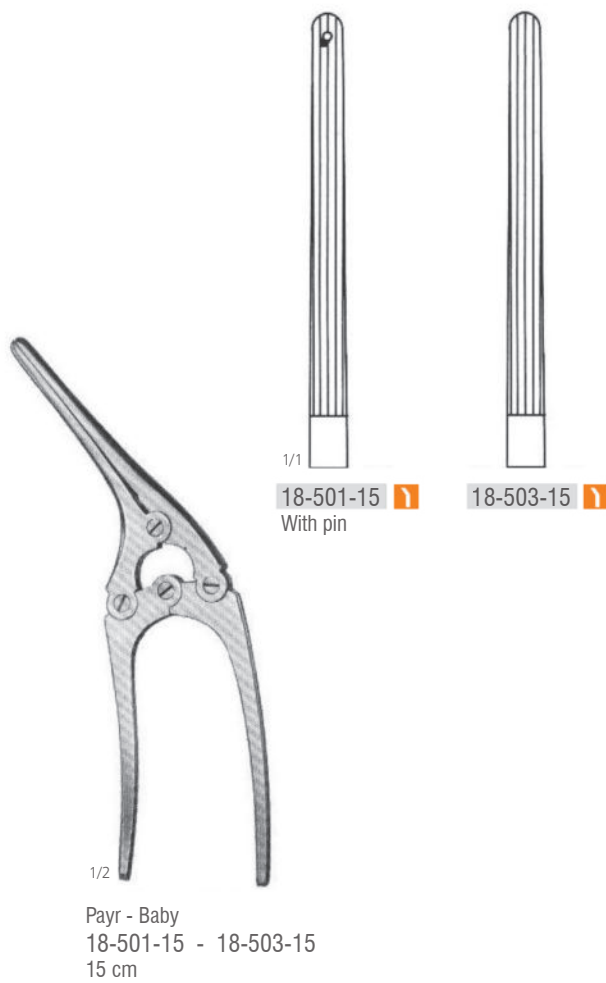

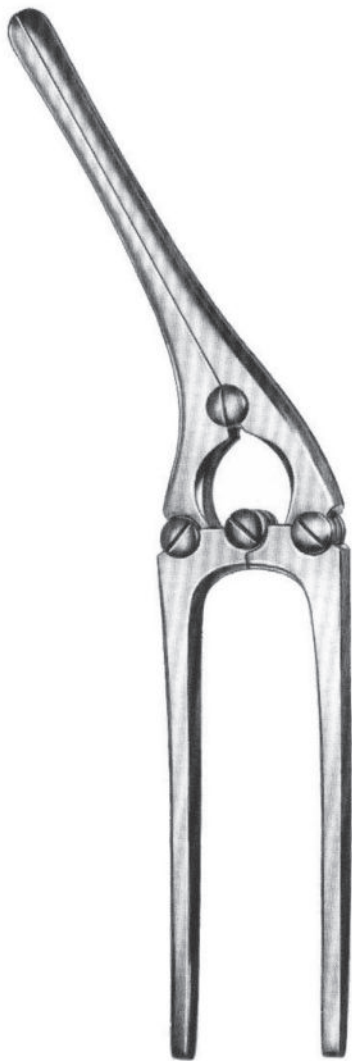

Payr  
18-511-21 - 18-525-35



18-501-21  
21 cm  
With pin



18-503-21  
21 cm



18-517-29  
29 cm  
With pin



18-519-29  
29 cm



18-523-35  
35 cm  
With pin



18-525-35  
35 cm

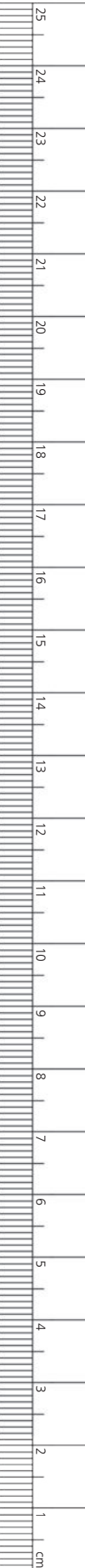

**Stomach Clamp Forceps**  
 Bauchklammerzange  
 Pinzas de pinza de estómago  
 Forceps de pince d'estomac

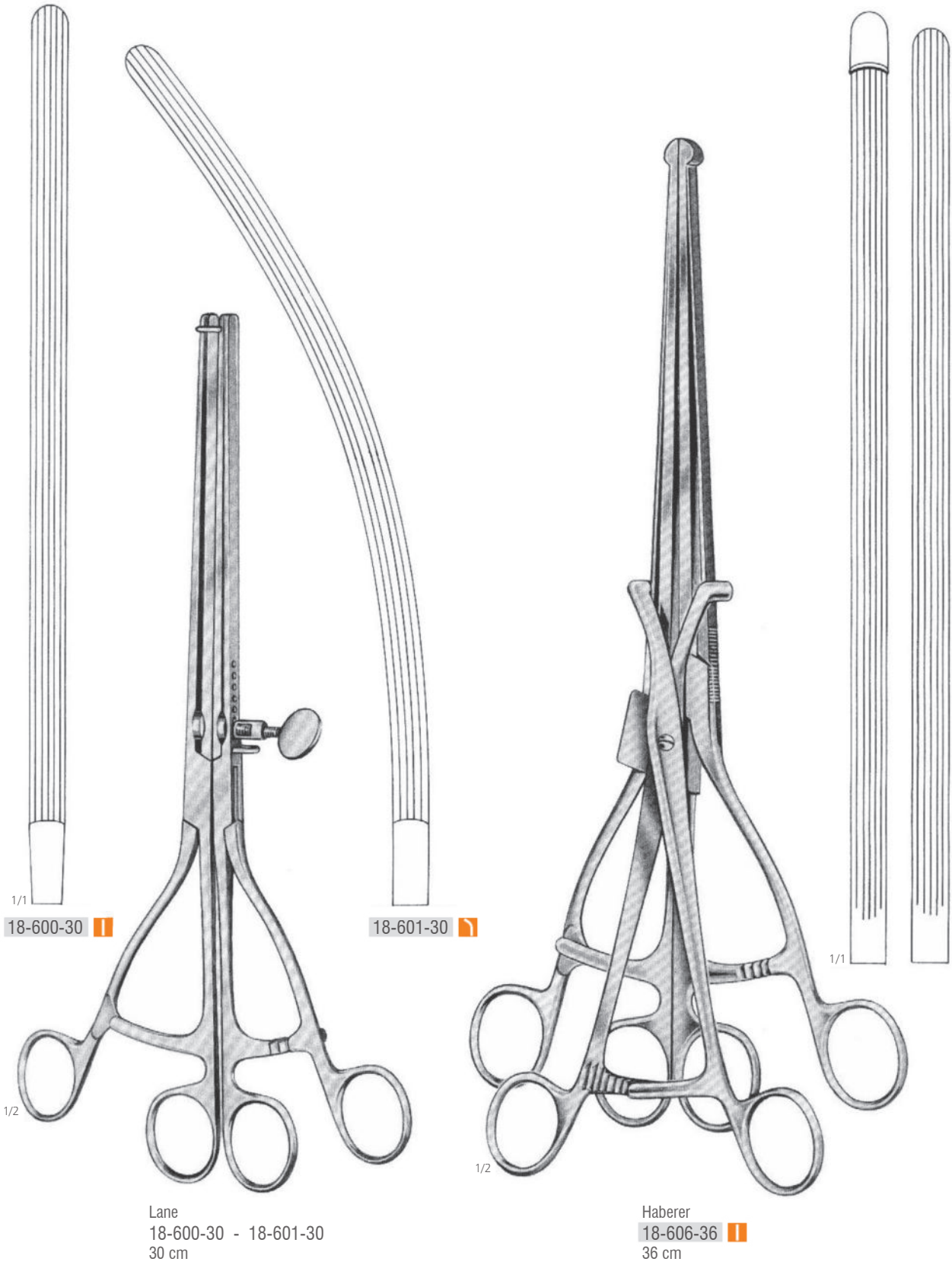

1/1  
 18-600-30 II

18-601-30 I

1/2

1/2

Lane  
 18-600-30 - 18-601-30  
 30 cm

Haberer  
 18-606-36 II  
 36 cm

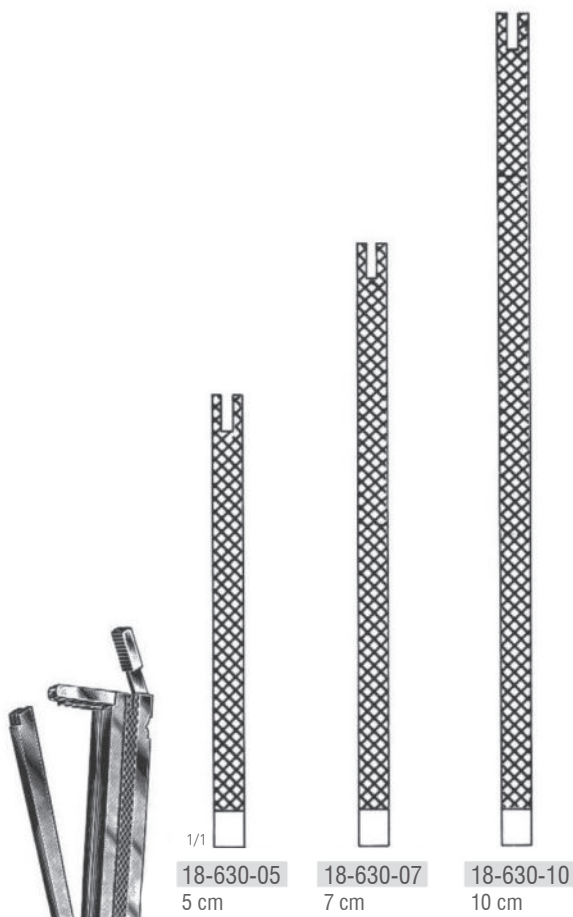

De Martel - Wolfson  
 18-630-05 - 18-630-10

Set of 3 anastomosis clamps

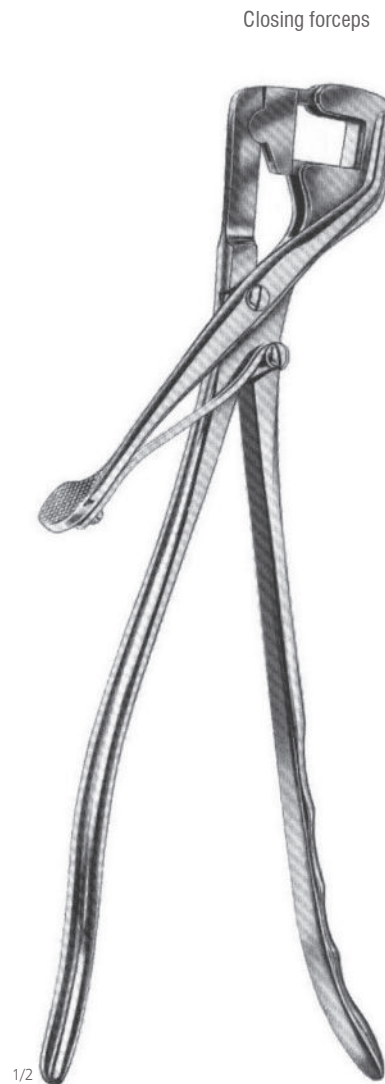

De Martel - Wolfson  
 18-637-26  
 26 cm

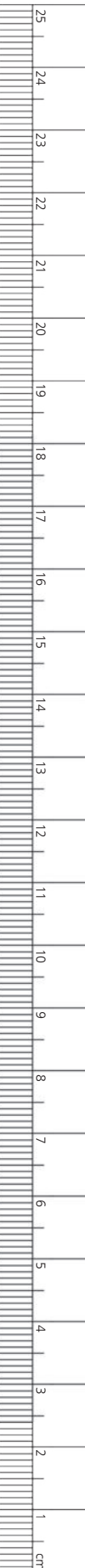

(Clamp Holder)  
Long



De Martel - Wolfson  
18-638-23  
23 cm

(Clamp Holder)  
Short



18-638-08  
8.5 cm



Stone - Watt  
18-650-07 7.5 cm  
18-650-10 10 cm



Stone - Watt  
18-652-00

Closing forceps



Stone  
18-654-15  
15 cm





1/2

Sims  
18-701-15  
15 cm

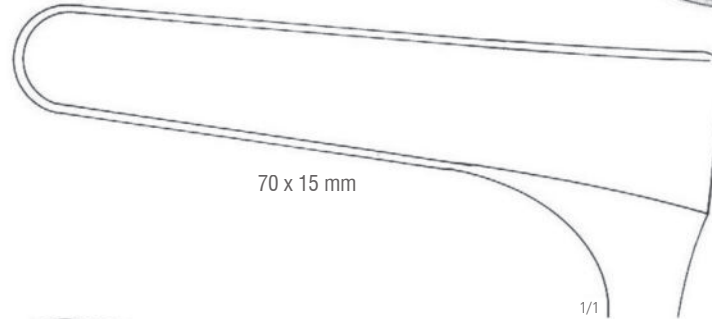

70 x 15 mm

1/1

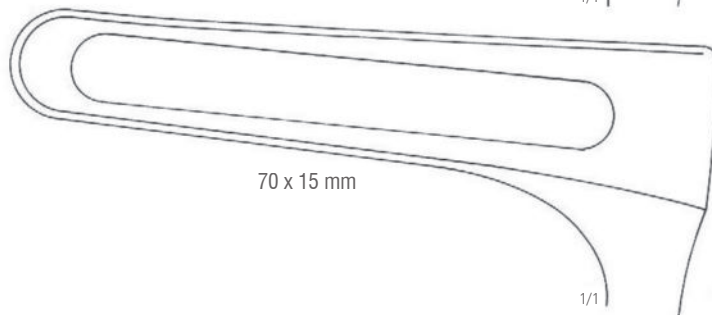

70 x 15 mm

1/1



1/2

Sims  
18-703-15  
15 cm



1/2

Czerny  
18-707-22  
22 cm

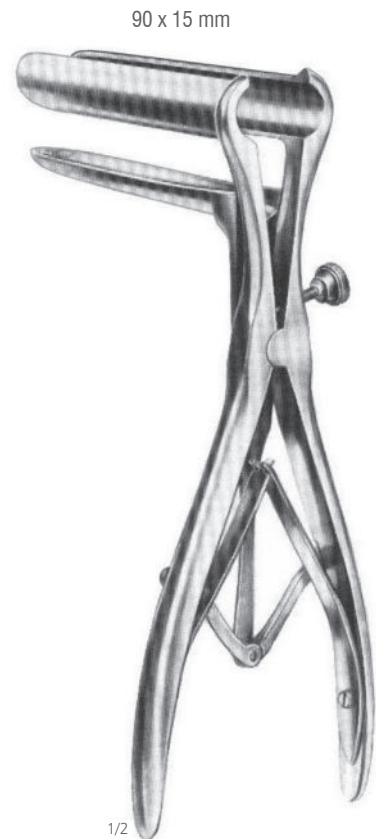

90 x 15 mm

1/2

Mathieu  
18-713-19  
19 cm

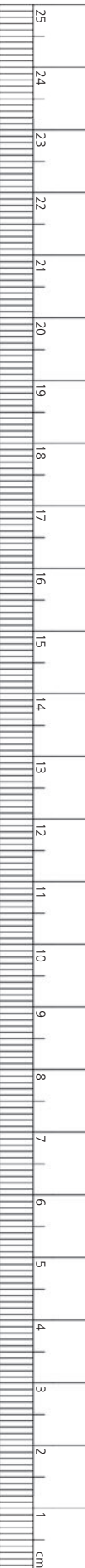



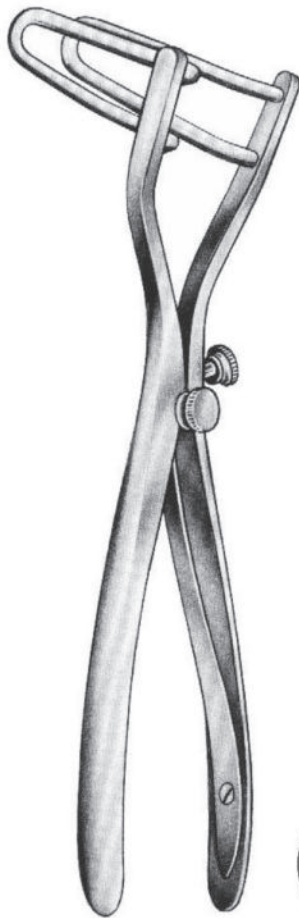

Schulze - Bergmann  
 18-725-06 - 18-725-15  
 22 cm

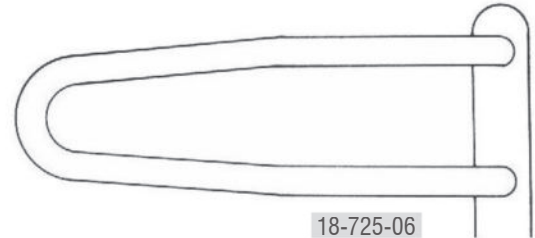

18-725-06  
 6 cm

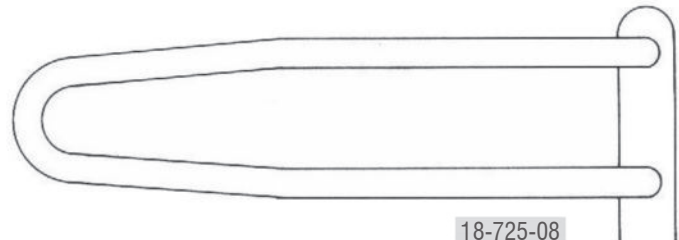

18-725-08  
 8 cm

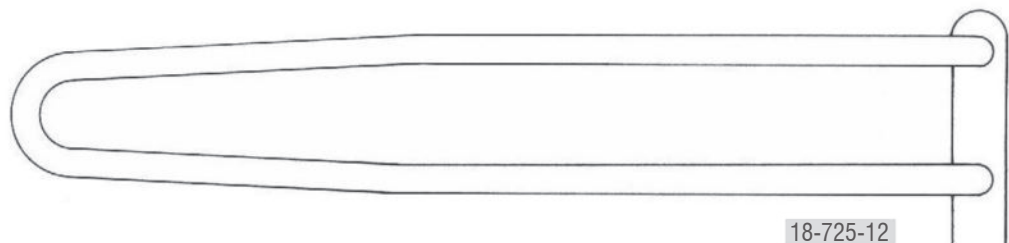

18-725-12  
 12.5 cm

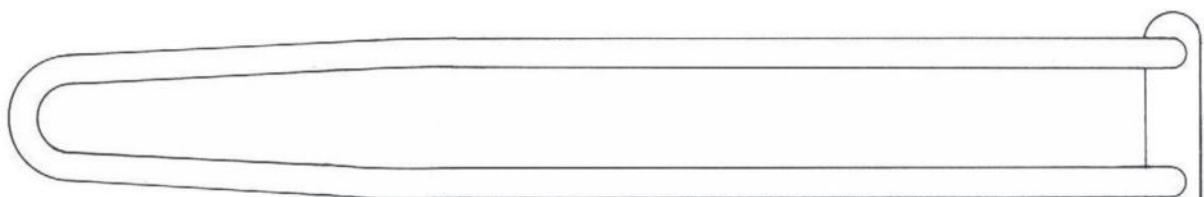

18-725-15  
 15 cm 1/1

85 x 25 mm

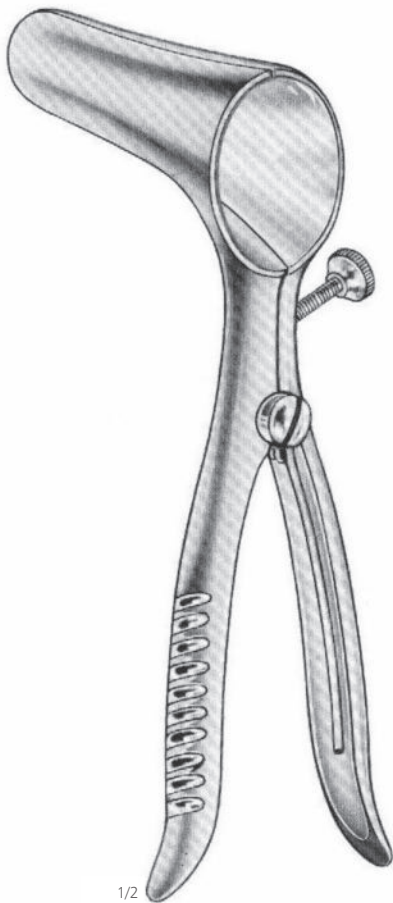

1/2

Pratt  
 18-731-21  
 21.5 cm

75 x 23 mm

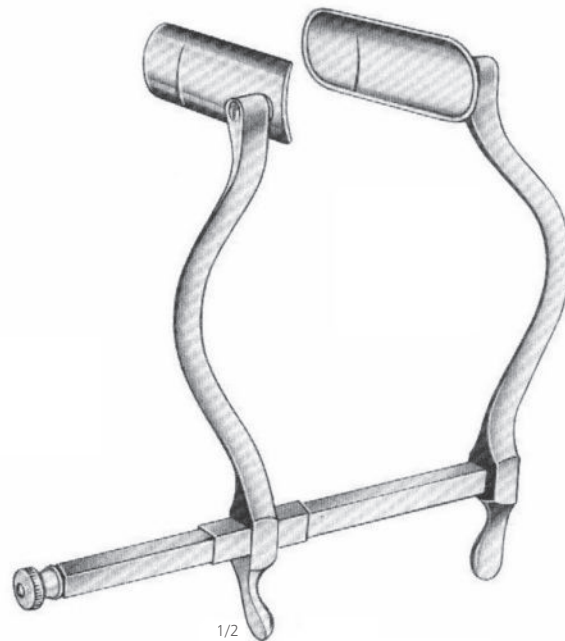

1/2

Smith - Buie  
 18-735-15  
 15 cm

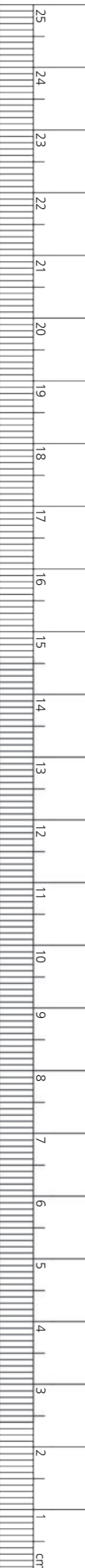

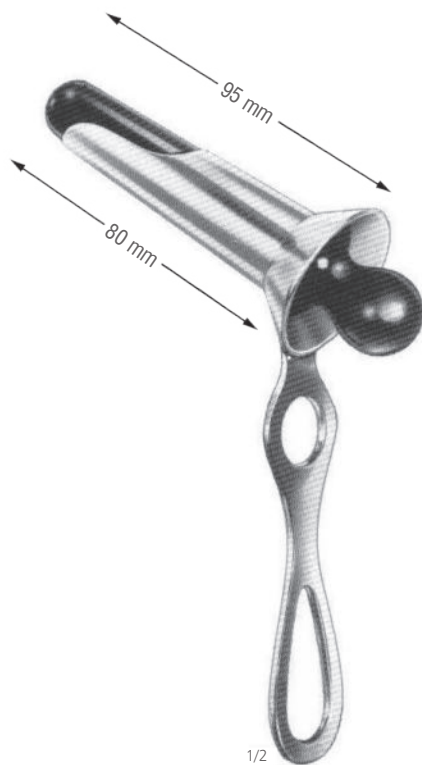

1/2

Ives - Fansler  
 18-741-15  
 Ø 22 mm



1/2

Newman  
 18-745-16 Ø 16 mm x 63 mm  
 18-745-19 Ø 19 mm x 63 mm  
 18-745-23 Ø 23 mm x 63 mm



1/2

Hirschmann

|           |                  |
|-----------|------------------|
| 18-761-01 | Ø 16 mm x 65 mm  |
| 18-761-02 | Ø 19 mm x 65 mm  |
| 18-761-03 | Ø 22 mm x 65 mm  |
| 18-761-04 | Ø 22 mm x 125 mm |

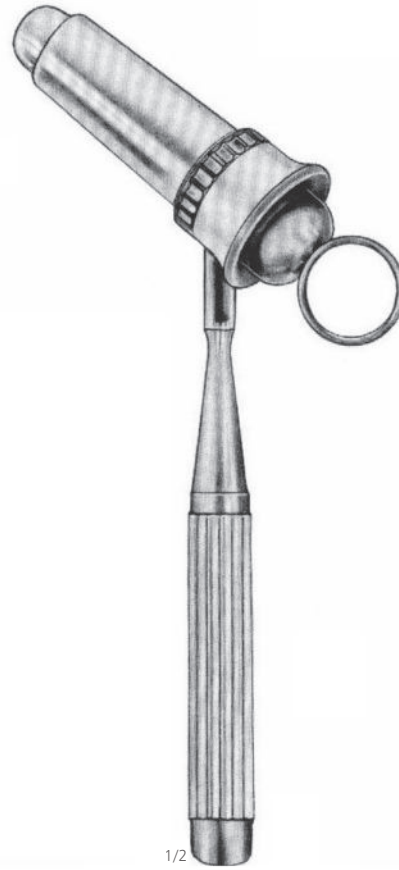

1/2

Bensaude

|           |                 |
|-----------|-----------------|
| 18-763-19 | Ø 16 mm x 70 mm |
| 18-763-22 | Ø 22 mm x 70 mm |

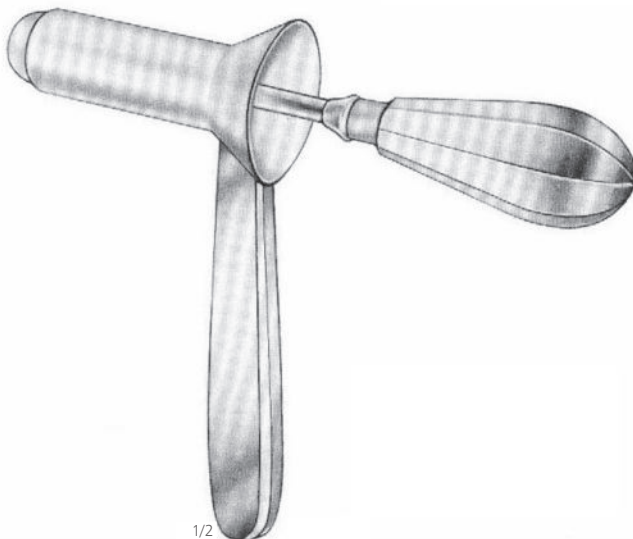

1/2

Kelly

|           |                  |
|-----------|------------------|
| 18-765-05 | Ø 22 mm x 50 mm  |
| 18-765-10 | Ø 22 mm x 100 mm |
| 18-765-14 | Ø 22 mm x 145 mm |
| 18-765-22 | Ø 22 mm x 200 mm |



1/2

Kelly

|           |                 |
|-----------|-----------------|
| 18-767-21 | Ø 21 mm x 50 mm |
| 18-767-27 | Ø 27 mm x 50 mm |

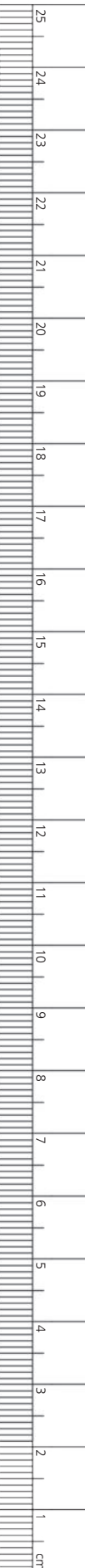

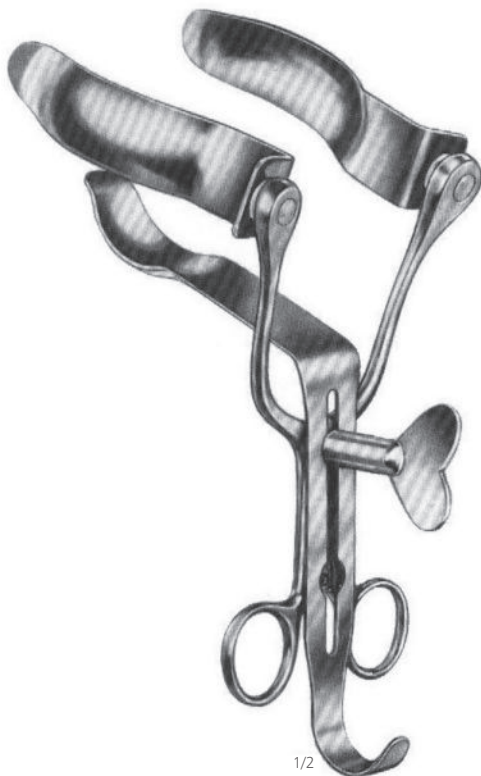

1/2

Alan Parks  
18-780-13  
13.5 mm

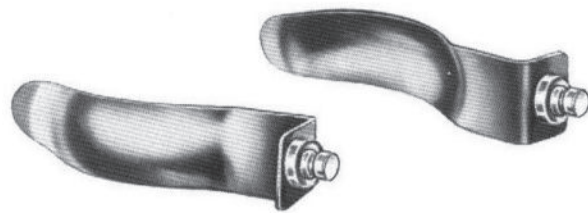

With pair of 2 blades and 1 center blade

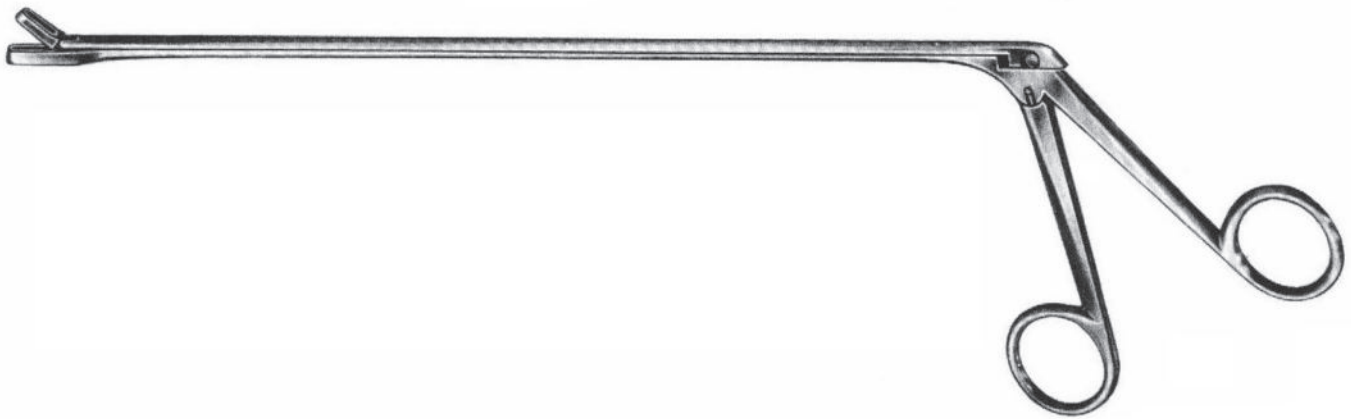

Yeomann  
 18-800-28 - 18-806-42

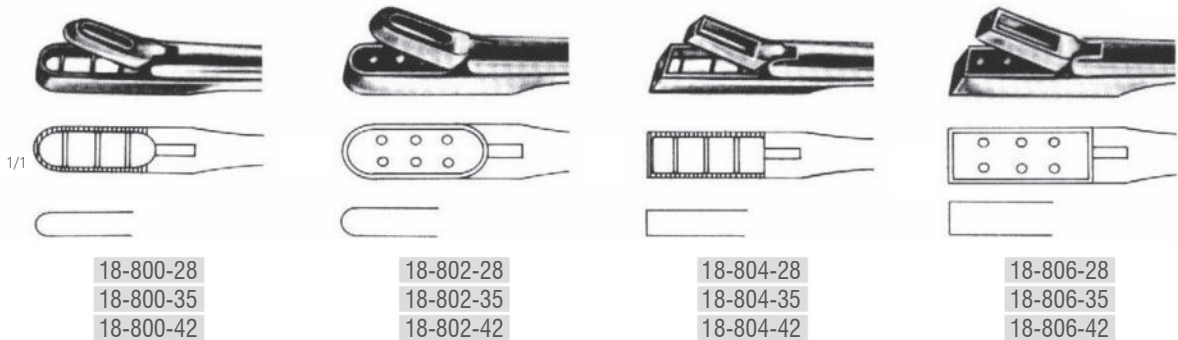

L = 28 cm  
 L = 35 cm  
 L = 42 cm

18-800-28  
 18-800-35  
 18-800-42

18-802-28  
 18-802-35  
 18-802-42

18-804-28  
 18-804-35  
 18-804-42

18-806-28  
 18-806-35  
 18-806-42

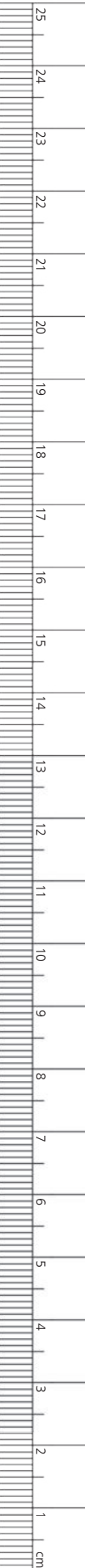

**Rectal Biopsy Specimen Forceps**  
**Mastdarm-Biopsiezangen**  
**Pinzas saca bocado para biopsia rectal**  
**Forceps de spécimen de biopsie rectale**

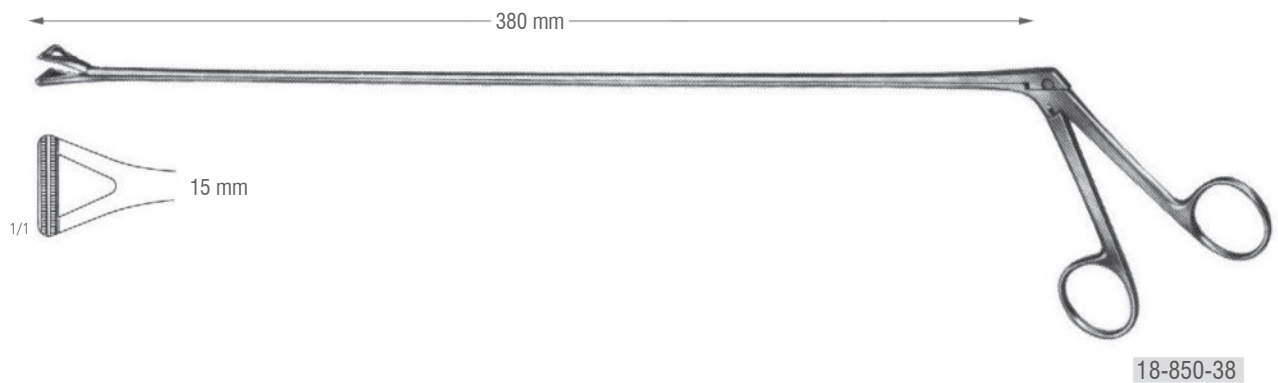
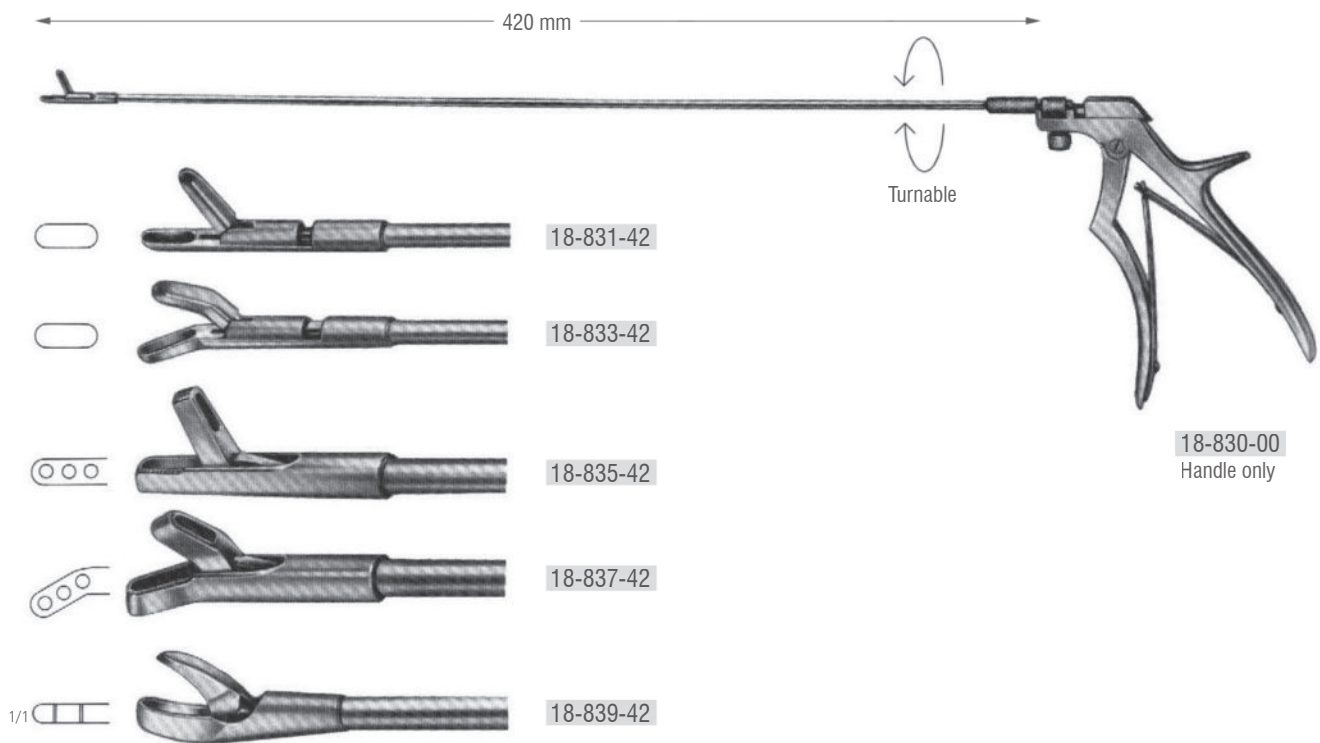



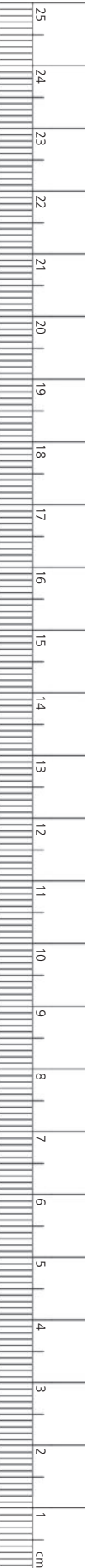
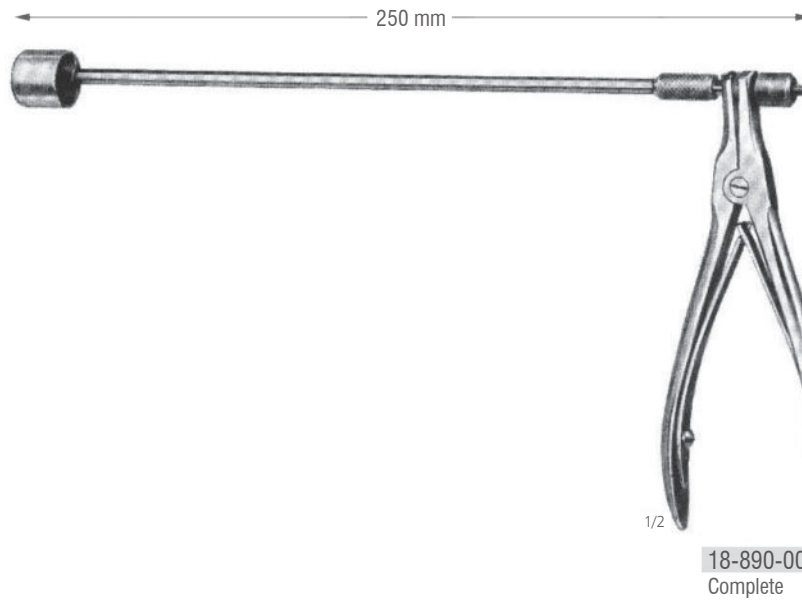
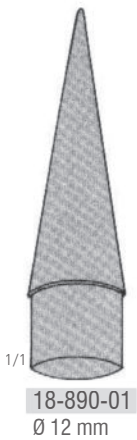
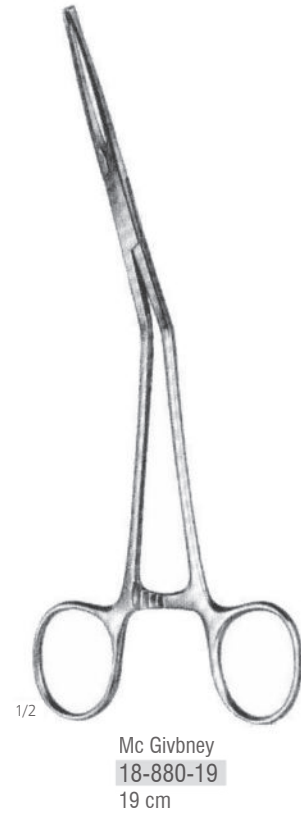
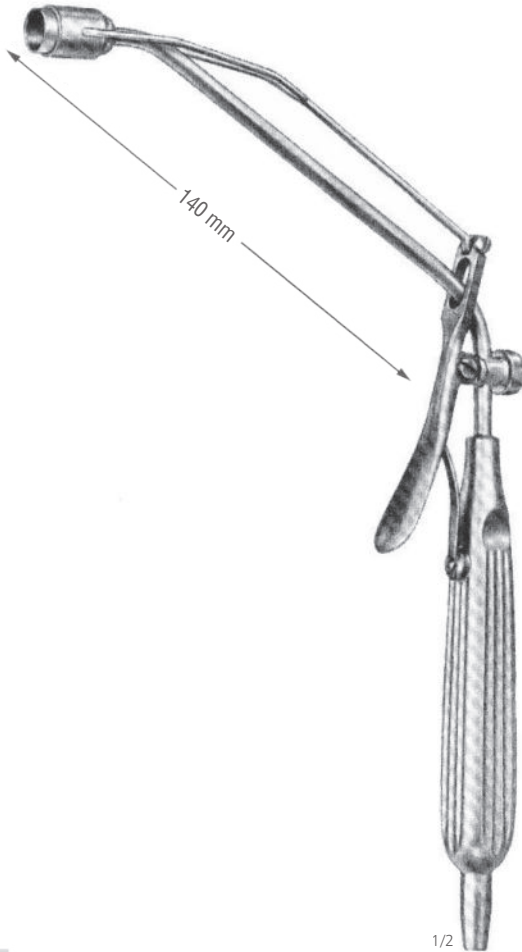
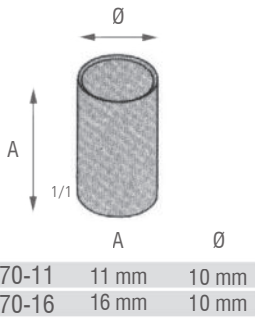
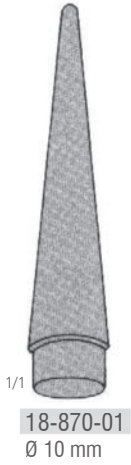



1/2

Rudd  
18-896-30  
30.5 cm