

20

Gynecology
Gynäkologie
Ginecologia
Gynécologie





Cusco
20-100-01 75 x 32 mm
20-100-02 85 x 35 mm
20-100-03 100 x 35 mm



Cusco - Virgin
20-102-01
75 x 17 mm



Cusco - Suisse
20-104-01 80 x 22 mm
20-104-02 100 x 25 mm
20-104-03 105 x 27 mm



Cusco
20-106-01 75 x 32 mm
20-106-02 85 x 35 mm
20-106-03 100 x 37 mm



Collin

20-110-01	85 x 30 mm
20-110-02	100 x 35 mm
20-110-03	110 x 40 mm



Pederson

20-114-01	75 x 13 mm
20-114-02	100 x 22 mm
20-114-03	120 x 25 mm



Grave

20-118-01	75 x 20 mm
20-118-02	95 x 35 mm
20-118-03	115 x 35 mm



Semm

20-120-01	90 x 14/18 mm
20-120-02	100 x 17/20 mm
20-120-03	100 x 25/30 mm

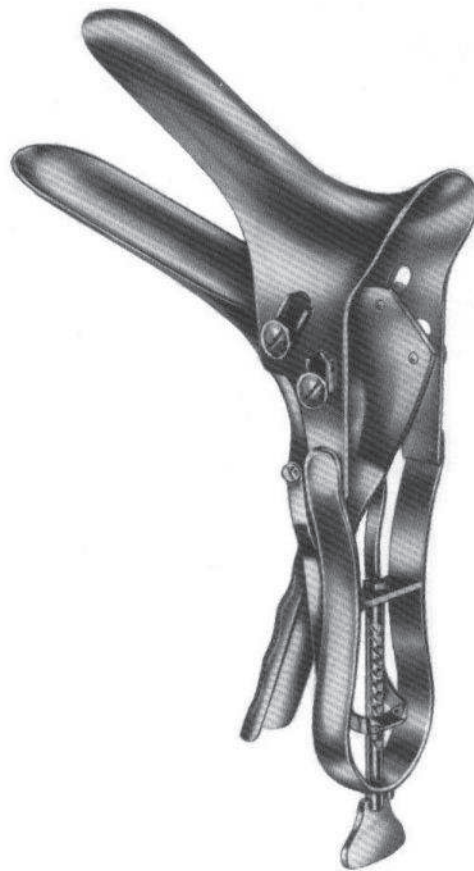

Seyffert

20-124-01	100 x 17 mm
20-124-02	110 x 33 mm

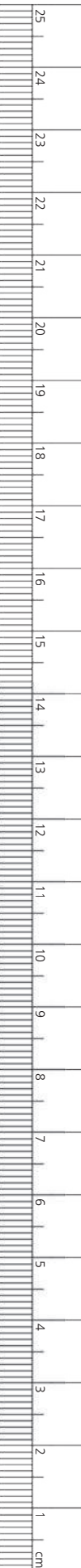



Trelet

20-136-01	Fig. 1	85 x 33 mm
20-136-02	Fig. 2	95 x 35 mm
20-136-03	Fig. 3	115 x 43 mm

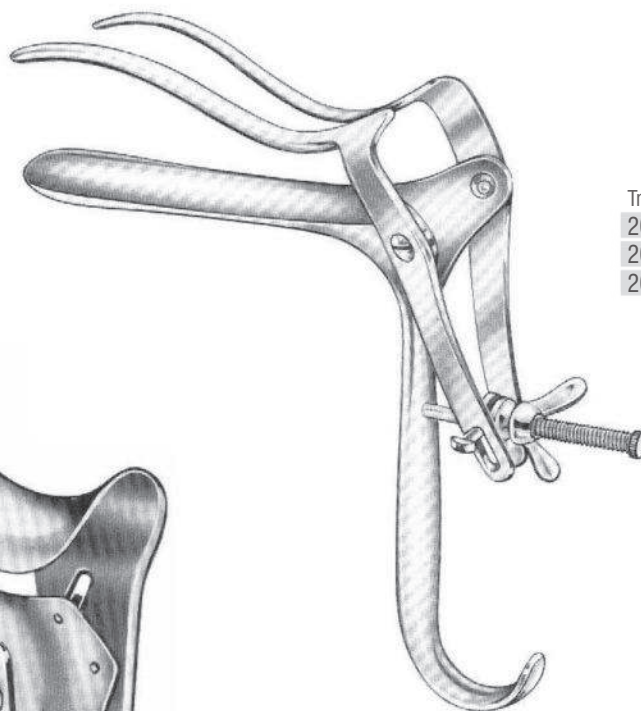

Nott

20-130-01	90 x 30 mm
20-130-02	110 x 30 mm

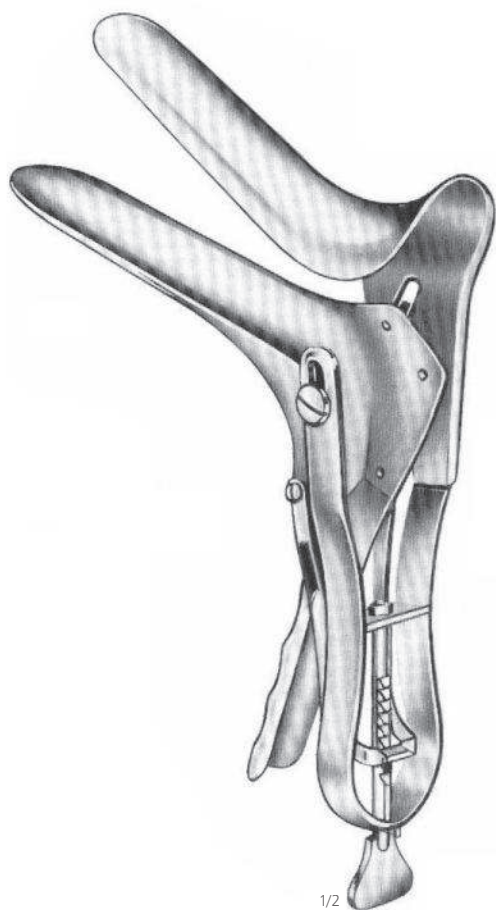

1/2

Seyffert
20-128-01
110 x 33 mm

A = With suction tube on upper blade
 B = With suction tube on lower blade
 C = With suction tubes on upper and lower blades

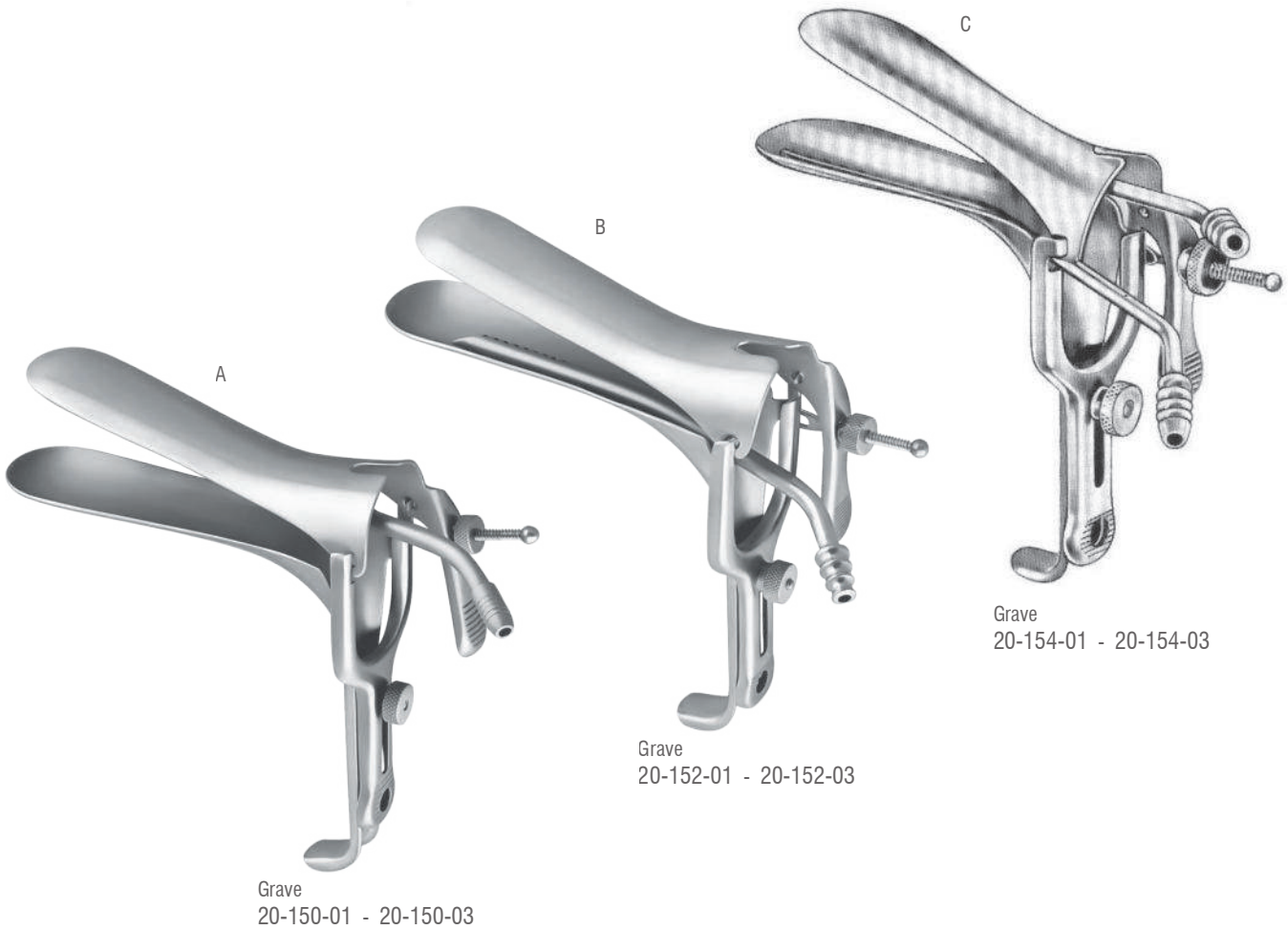

A	B	B	
20-150-01	20-152-01	20-154-01	76 x 13 mm
20-150-02	20-152-02	20-154-02	101 x 22 mm
20-150-03	20-152-03	20-154-03	120 x 35 mm

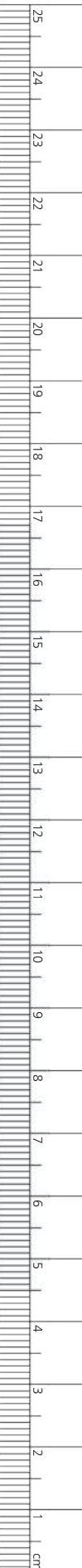

A = With suction tube on upper blade
 B = With suction tube on lower blade
 C = With suction tubes on upper and lower blades

X = 135° angled
 Y = Right side open
 Z = 135° angled and right side open

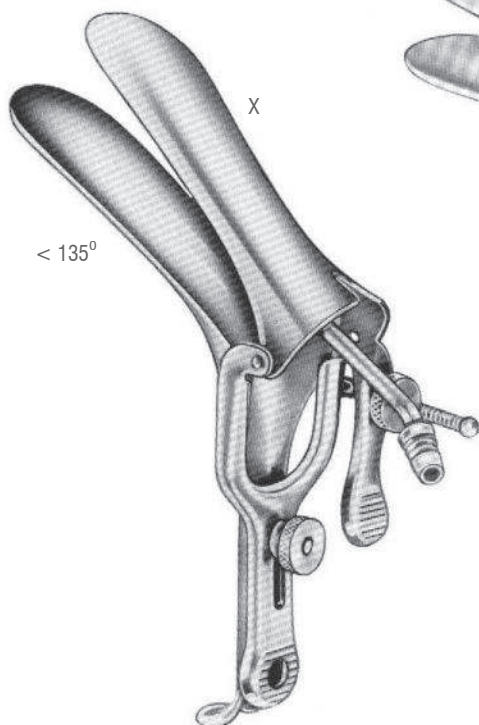

Grave - Special
 20-160-01 - 20-160-03
 101 x 35 mm

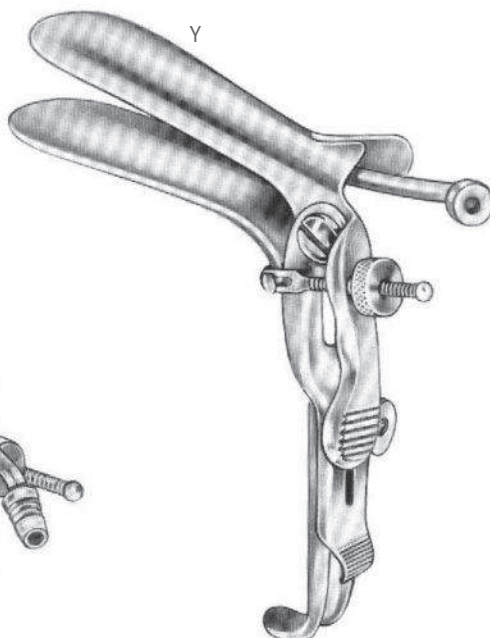

Grave - Special
 20-162-01 - 20-162-03
 101 x 35 mm

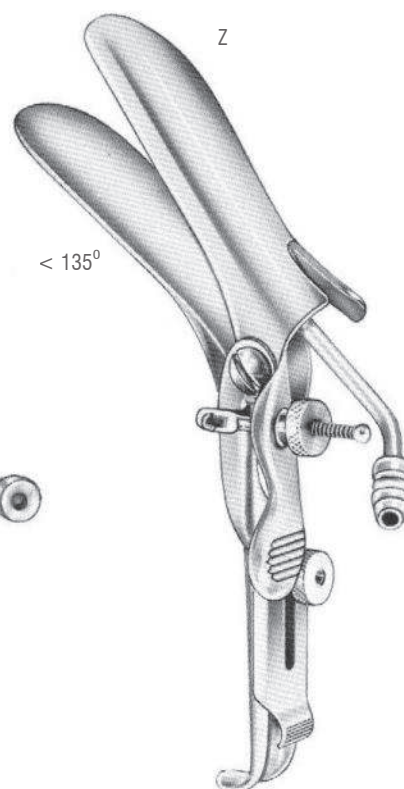

Grave - Special
 20-164-01 - 20-164-03
 101 x 35 mm

X	Y	Z
20-160-01	20-162-01	20-164-01
20-160-02	20-162-02	20-164-02
20-160-03	20-162-03	20-164-03

- A = With suction tube on upper blade
- B = With suction tube on lower blade
- C = With suction tubes on upper and lower blades



Perderson
 20-170-01 - 20-174-03

A	B	B	
20-170-01	20-172-01	20-174-01	76 x 13 mm
20-170-02	20-172-02	20-174-02	101 x 22 mm
20-170-03	20-172-03	20-174-03	120 x 25 mm

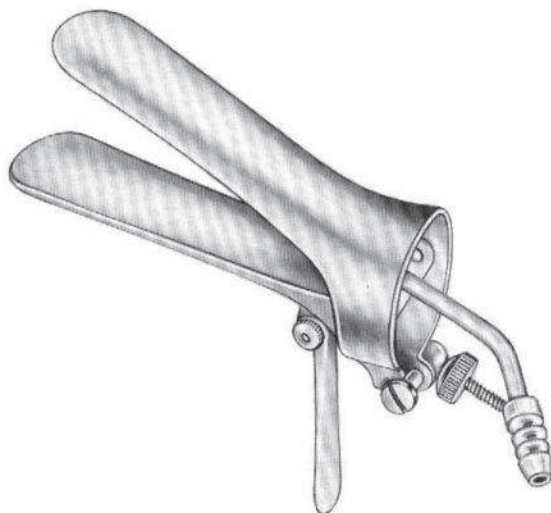

Cusco
 20-180-01 - 20-184-03

A	B	B	
20-180-01	20-182-01	20-184-01	105 x 25 mm
20-180-02	20-182-02	20-184-02	107 x 29 mm
20-180-03	20-182-03	20-184-03	115 x 35 mm

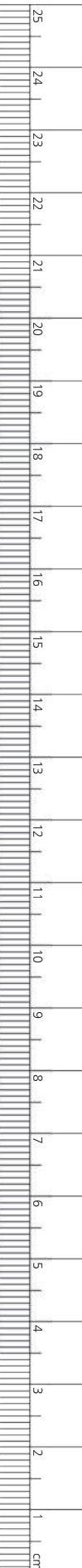



Sims
20-200-01 65 x 25 mm
70 x 30 mm



Sims
20-200-02 70 x 30 mm
70 x 35 mm



Sims
20-200-03 85 x 35 mm
90 x 40 mm

Specula

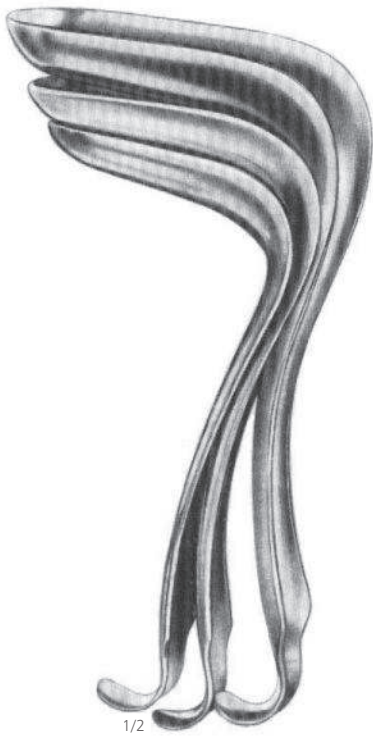

1/2

Kristeller

20-202-01	Fig. 1	70 x 27 mm
20-202-02	Fig. 2	80 x 30 mm
20-202-03	Fig. 3	90 x 36 mm

Retractor



1/2

Kristeller

20-203-01	Fig. 1	75 x 23 mm
20-203-02	Fig. 2	85 x 26 mm
20-203-03	Fig. 3	100 x 32 mm

Set of 1 Speculum and
1 Retractor each



Kristeller

20-205-01	1 x 20-202-01
	1 x 20-203-01
20-205-02	1 x 20-202-02
	1 x 20-203-02
20-205-03	1 x 20-202-03
	1 x 20-203-03

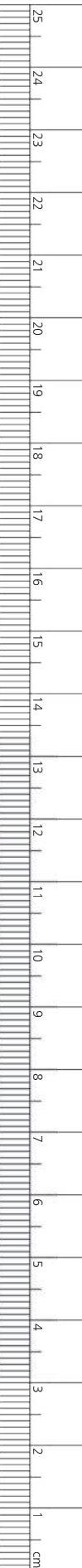

Specula



Kristeller

20-210-01	Fig. 1	105 x 18 mm
20-210-02	Fig. 2	105 x 21 mm

Retractor



Kristeller

20-211-01	Fig. 1	110 x 14 mm
20-211-02	Fig. 2	110 x 17 mm

Set of 1 Speculum and
1 Retractor each



Kristeller

20-213-01	1 x 20-210-01
	1 x 20-211-01
20-213-02	1 x 20-210-02
	1 x 20-211-02

Specula flat hollow



Specula



1/2

Kristeller

20-216-01	Fig. 1	105 x 26 mm
20-216-02	Fig. 2	105 x 28 mm
20-216-03	Fig. 3	105 x 33 mm

Retractor



1/2

Kristeller

20-217-01	Fig. 1	115 x 22 mm
20-217-02	Fig. 2	115 x 24 mm
20-217-03	Fig. 3	115 x 29 mm

Set of 1 Speculum and
1 Retractor each



Kristeller

20-219-01	1 x 20-216-01
	1 x 20-217-01
20-219-02	1 x 20-216-02
	1 x 20-217-02
20-219-03	1 x 20-216-03
	1 x 20-217-03

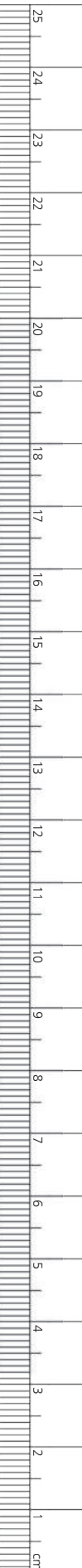

Specula deep hollow

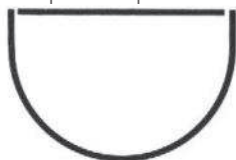

Specula

Retractor

Set of 1 Speculum and
1 Retractor each



Kristeller

20-222-01	Fig. 1	110 x 27 mm
20-222-02	Fig. 2	110 x 30 mm
20-222-03	Fig. 3	110 x 36 mm

Kristeller

20-223-01	Fig. 1	115 x 23 mm
20-223-02	Fig. 2	115 x 26 mm
20-223-03	Fig. 3	115 x 32 mm

Kristeller

20-225-01	1 x 20-222-01
	1 x 20-223-01
20-225-02	1 x 20-223-02
	1 x 20-223-02
20-225-03	1 x 20-222-03
	1 x 20-223-03

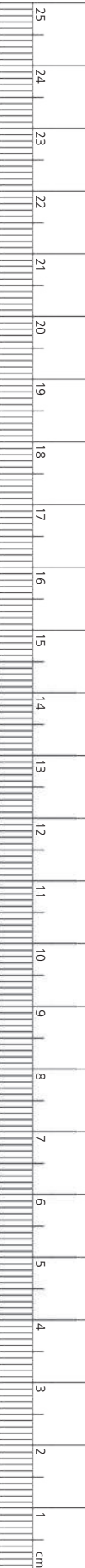

Specula

Retractor



Kallmorgen

20-230-01	70 x 40 mm	Fig. 1	20-231-01	70 x 33 mm
20-230-02	90 x 40 mm	Fig. 2	20-231-02	90 x 33 mm

Specula

Retractor



Mathieu

20-236-01	95 x 16 - 26 mm	Fig. 1	20-237-01	100 x 11 - 20 mm
20-236-02	95 x 16 - 30 mm	Fig. 2	20-237-02	100 x 14 - 26 mm

Set

20-233-01	1 x 20-230-01 1 x 20-231-01
20-233-02	1 x 20-230-02 1 x 20-231-02

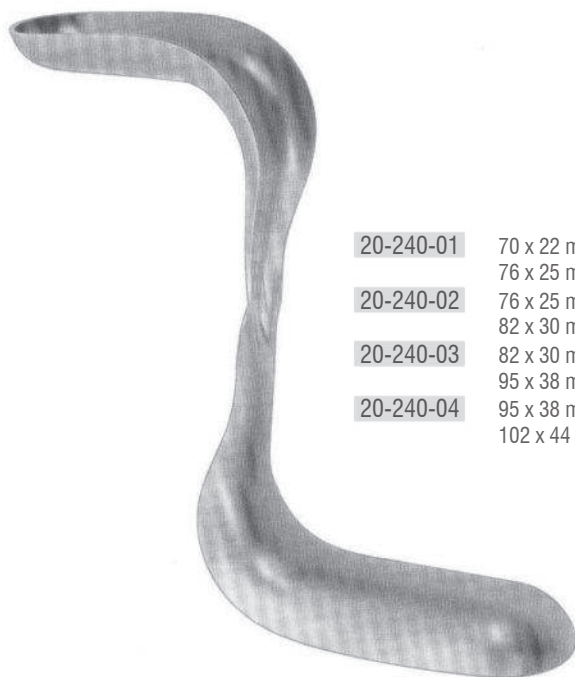

20-240-01	70 x 22 mm 76 x 25 mm
20-240-02	76 x 25 mm 82 x 30 mm
20-240-03	82 x 30 mm 95 x 38 mm
20-240-04	95 x 38 mm 102 x 44 mm

Breisky

20-240-01	14 cm
20-240-02	14 cm
20-240-03	17 cm
20-240-04	17 cm

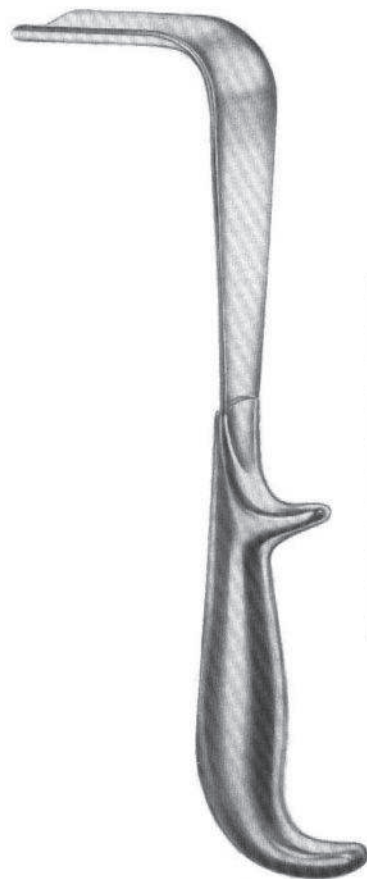
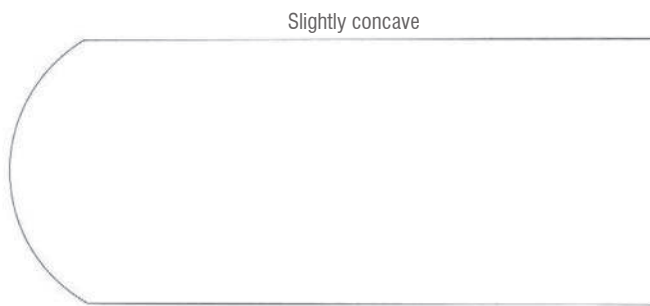

20-250-01	Fig. 1	55 x 35 mm
20-250-02	Fig. 2	85 x 35 mm
20-250-03	Fig. 3	115 x 35 mm

20-251-01	Fig. 1	55 x 45 mm
20-251-02	Fig. 2	85 x 45 mm
20-251-03	Fig. 3	115 x 45 mm
20-251-04	Fig. 4	160 x 45 mm

20-252-01	Fig. 1	55 x 60 mm
20-252-02	Fig. 2	85 x 60 mm
20-252-03	Fig. 3	115 x 60 mm
20-252-04	Fig. 4	160 x 60 mm

Doyen
20-250-01 - 20-252-04

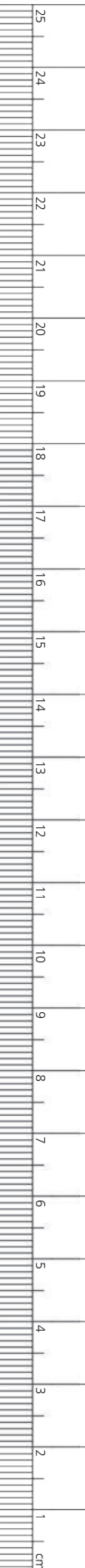

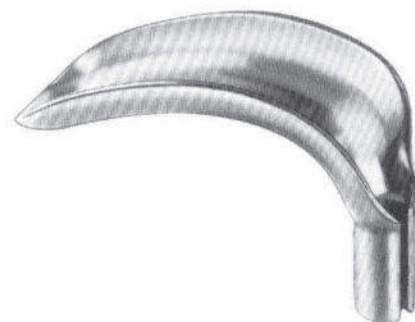
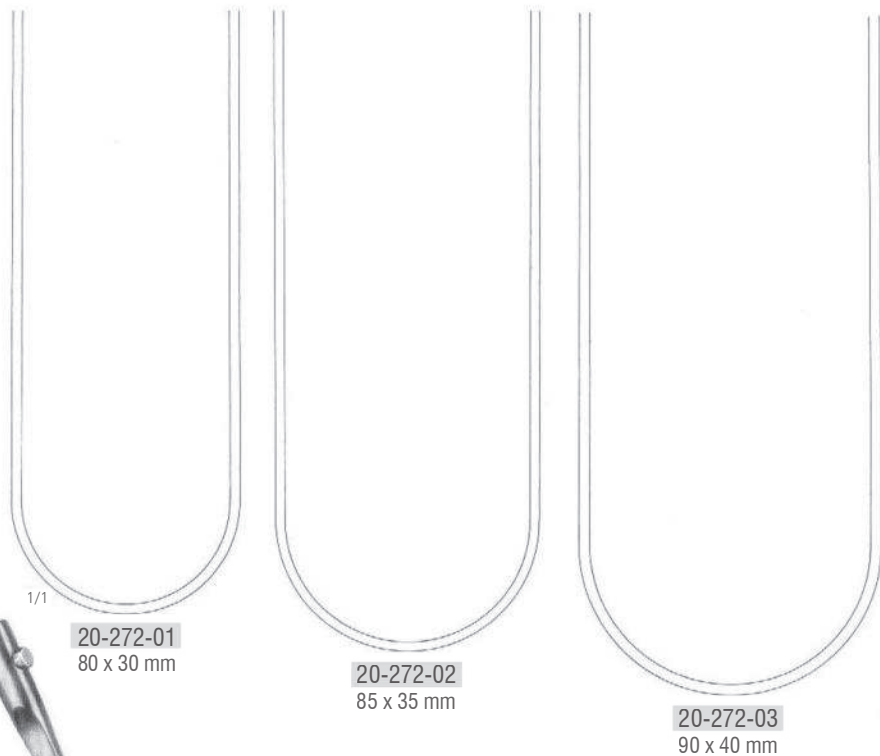

Scherbak
20-272-01 - 20-272-03

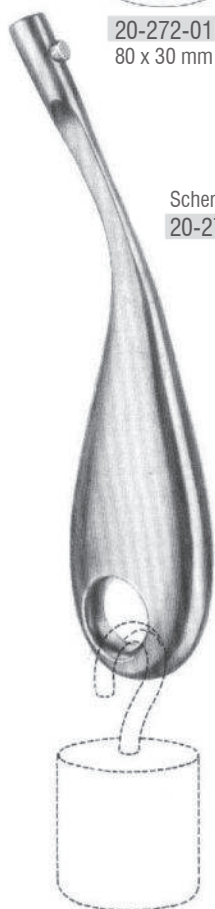

Scherbak Handle
20-272-14

20-272-10
400 g

20-272-12
800 g



Scherbak Weight
20-272-10 - 20-272-12



20-272-04
55 x 40/60 mm

20-272-05
70 x 45/70 mm

Scherbak
20-272-04 - 20-272-05

Scherbak	
20-274-00	Complete
20-272-01	x 1
20-272-02	x 1
20-272-03	x 1
20-272-04	x 1
20-272-05	x 1
20-272-10	x 1
20-272-14	x 1

Scherbak	
20-275-00	Complete
20-272-01	x 1
20-272-02	x 1
20-272-03	x 1
20-272-04	x 1
20-272-05	x 1
20-272-12	x 1
20-272-14	x 1



Auvard - Berlind
20-290-01 83 x 38 mm 1.14 kg
20-290-02 102 x 45 mm 1.14 kg
Fixed with hole

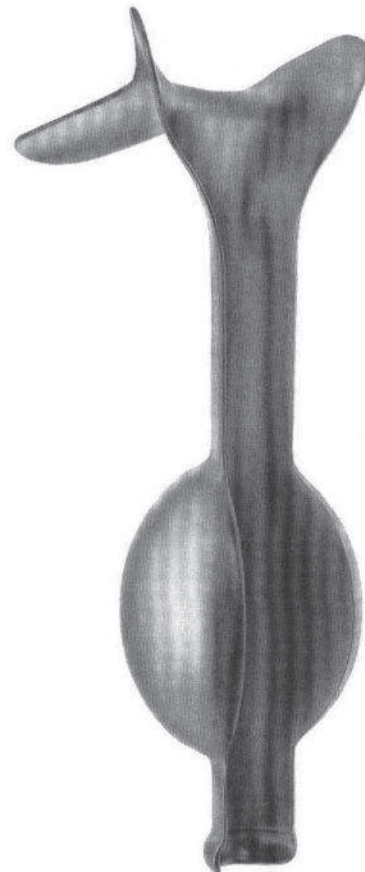

Auvard
20-292-01 83 x 38 mm 0.91 kg
20-292-02 83 x 38 mm 1.14 kg
20-292-03 83 x 38 mm 1.36 kg
Fixed

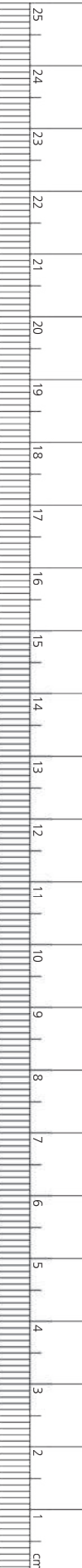

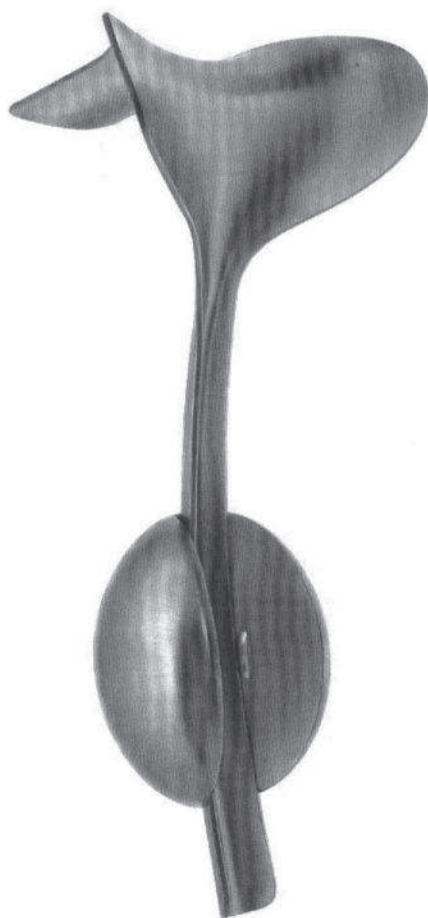

Auvard
 20-296-01 83 x 38 mm 1.14 kg
 20-296-02 102 x 45 mm 1.14 kg
 Detachable weight

Complete with detachable strainer

80 x 42 mm

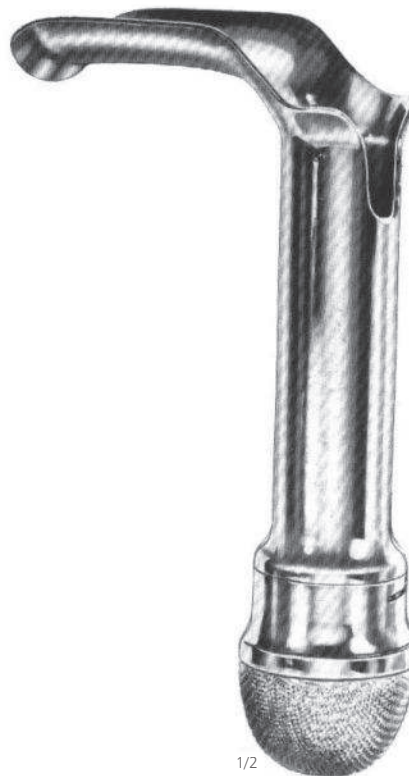

1/2

Weissbarth
 20-298-24

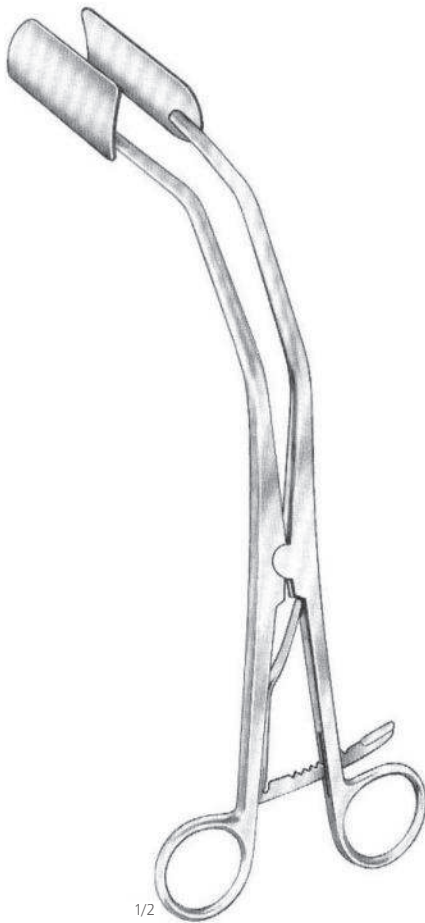

1/2

New Port
 20-300-25
 25 cm

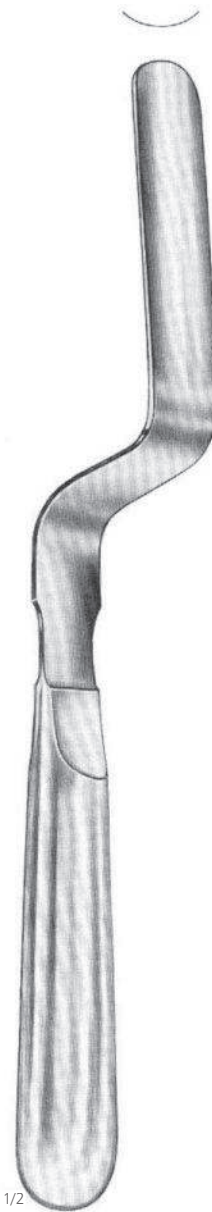

1/2

Landau
 20-310-01 105 x 28 mm
 20-310-02 105 x 38 mm

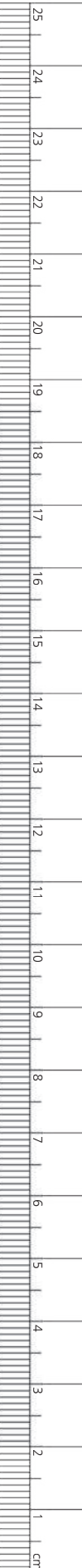



20-314-20	100 x 20 mm
20-314-25	100 x 25 mm
20-314-30	100 x 30 mm
20-314-35	100 x 35 mm
20-314-40	100 x 40 mm

20-315-20	130 x 20 mm
20-315-25	130 x 25 mm
20-315-30	130 x 30 mm
20-315-35	130 x 35 mm
20-315-40	130 x 40 mm

20-316-20	155 x 20 mm
20-316-25	155 x 25 mm
20-316-30	155 x 30 mm
20-316-35	155 x 35 mm
20-316-40	155 x 40 mm

1/2

Breisky
 20-314-20 - 20-316-40



1/2

Doyen
 20-320-24
 24 cm

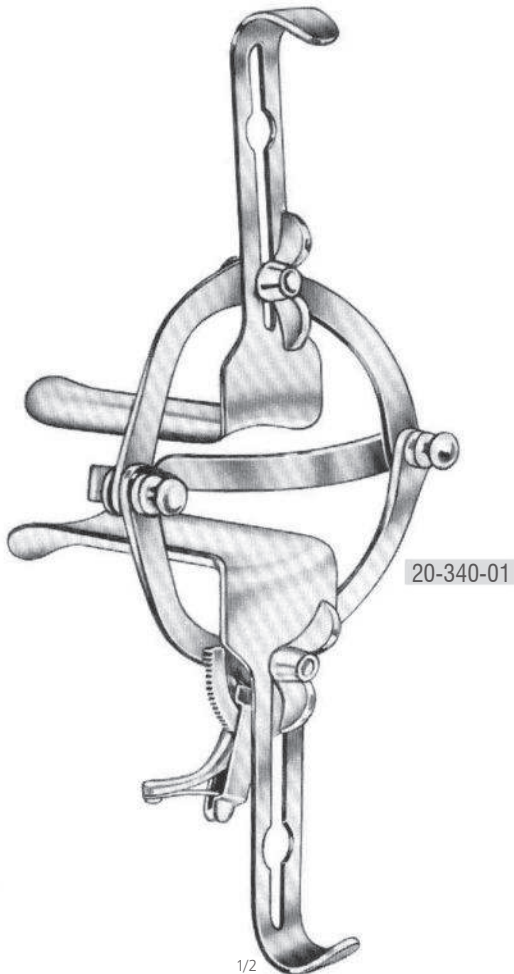

O'Sullivan - O'Connor
 20-340-00 Complete
 1 x 20-340-01
 1 x 20-340-02
 1 x 20-340-03
 1 x 20-340-04



20-340-04
 90 x 45 mm



Friedman
 20-346-10
 10 cm

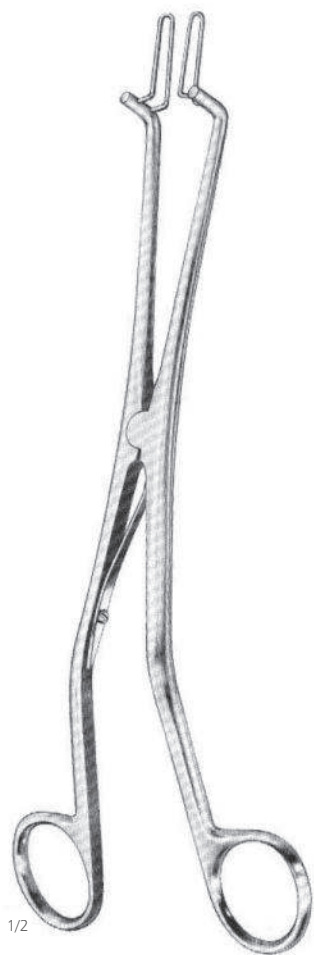

Kogan
20-360-01
24 cm

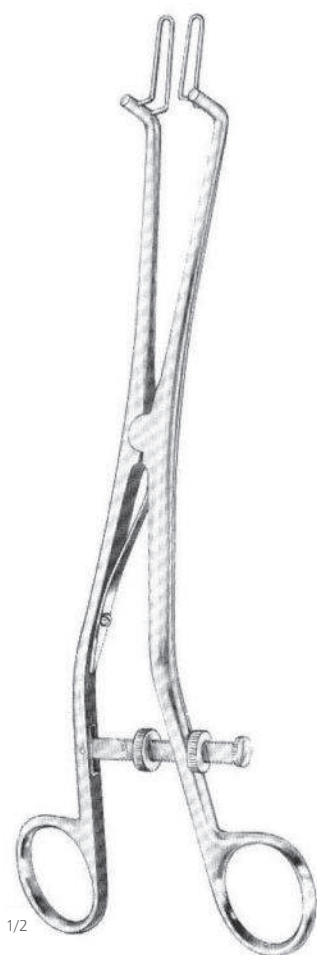
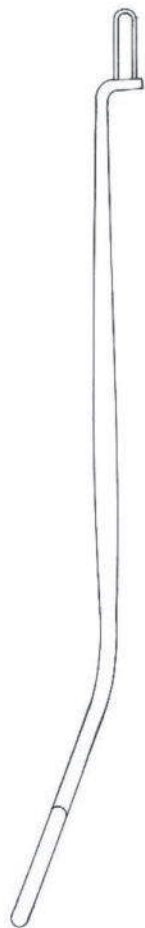

Kogan
20-360-02
24 cm

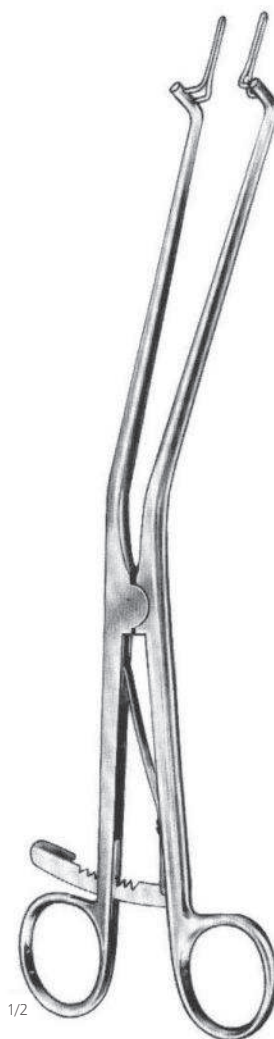

Kogan
20-360-03 - 20-364-07
24 cm





Hegar
20-400-01 - 20-401-19

Ø mm	With sloped handle	
1.0	20-400-01	-
1.5	-	20-401-01
2.0	20-400-02	-
2.5	-	20-401-02
3.0	20-400-03	-
3.5	-	20-401-03
4.0	20-400-04	-
4.5	-	20-401-04
5.0	20-400-05	-
5.5	-	20-401-05
6.0	20-400-06	-
6.5	-	20-401-06
7.0	20-400-07	-
7.5	-	20-401-07
8.0	20-400-08	-
8.5	-	20-401-08
9.0	20-400-09	-
9.5	-	20-401-09
10.0	20-400-10	-
10.5	-	20-401-10
11.0	20-400-11	-
11.5	-	20-401-11
12.0	20-400-12	-
12.5	-	20-401-12
13.0	20-400-13	-
13.5	-	20-401-13
14.0	20-400-14	-
14.5	-	20-401-14
15.0	20-400-15	-
15.5	-	20-401-15
16.0	20-400-16	-
16.5	-	20-401-16
17.0	20-400-17	-
17.5	-	20-401-17
18.0	20-400-18	-
18.5	-	20-401-18
19.0	20-400-19	-
19.5	-	20-401-19
20.0	20-400-20	-
21.0	20-400-21	-
22.0	20-400-22	-
23.0	20-400-23	-
24.0	20-400-24	-
25.0	20-400-25	-
26.0	20-400-26	-

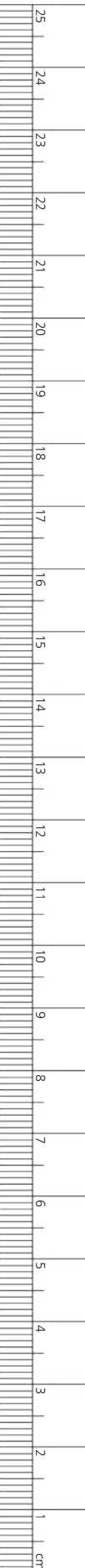

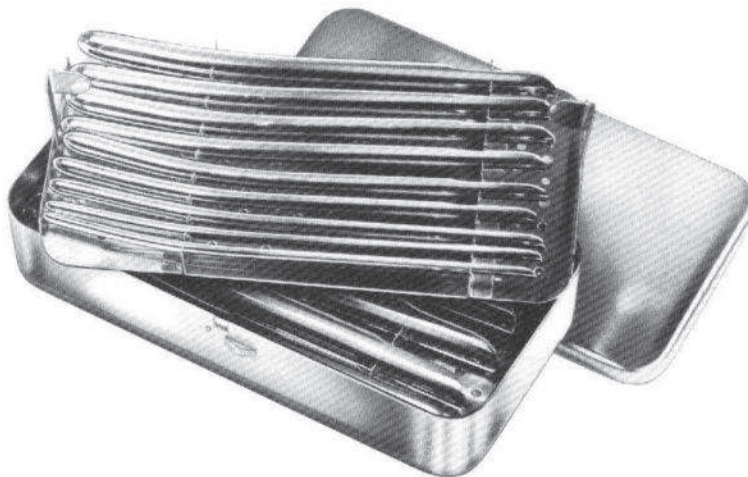

Description			
20-406-14	Set of 14 dilators	20-400-04 - 20-400-17	(Ø 4.0 - 17.0 mm) in metal case
20-406-26	Set of 26 dilators	20-400-01 - 20-400-26	(Ø 1.0 - 26.0 mm) in metal case
20-408-14	Set of 14 dilators	20-400-04 - 20-400-17	(Ø 4.0 - 17.0 mm) in canvas case
20-408-26	Set of 26 dilators	20-400-01 - 20-400-26	(Ø 1.0 - 26.0 mm) in canvas case



1/2

Ø mm	
1.0/2.0	20-420-02
3.0/4.0	20-420-04
5.0/6.0	20-420-06
7.0/8.0	20-420-08
9.0/10.0	20-420-10
11.0/12.0	20-420-12
13.0/14.0	20-420-14
15.0/16.0	20-420-16
17.0/18.0	20-420-18
19.0/20.0	20-420-20
21.0/22.0	20-420-22
23.0/24.0	20-420-24
25.0/26.0	20-420-26

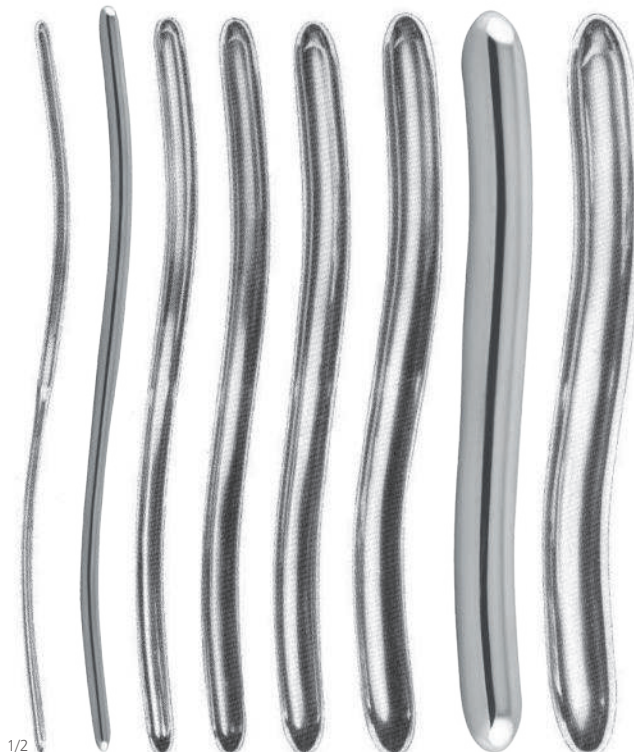

1/2

Hegar
 20-420-02 - 20-420-26

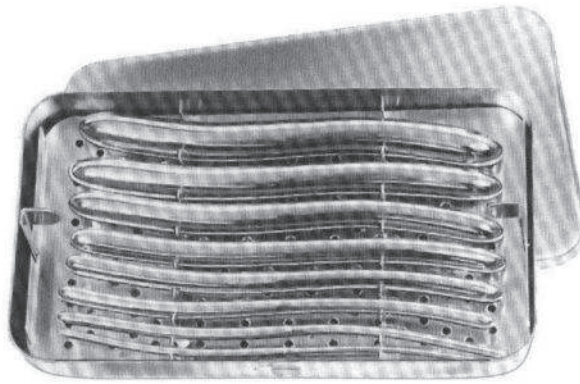

Description

20-426-08 Set of 8 dilators 20-420-04 - 20-420-18 (Ø 3.0/4.0 - 17.0/18.0 mm) in metal case



Description

20-426-18 Set of 13 dilators 20-420-02 - 20-420-26 (Ø 1.0/2.0 - 25.0/26.0 mm) in metal case

20-428-18 Set of 13 dilators 20-420-02 - 20-420-26 (Ø 1.0/2.0 - 25.0/26.0 mm) in canvas case



Description

20-428-08 Set of 8 dilators 20-420-04 - 20-420-18 (Ø 3.0/4.0 - 17.0/18.0 mm) in canvas case

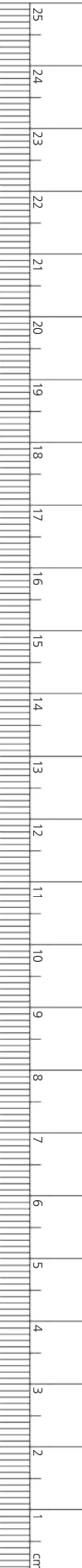
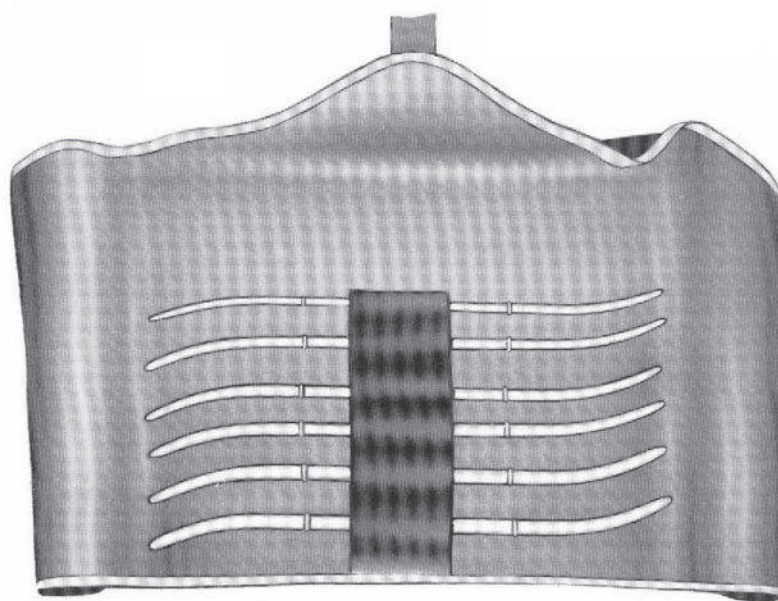



Fig.	Ø mm	Hank
9/10	4.5/5.0	20-440-10
11/12	5.5/6.0	20-440-12
13/14	6.5/7.0	20-440-14
15/16	7.5/8.0	20-440-16
17/18	8.5/9.0	20-440-18
19/20	9.5/10.0	20-440-20

American scale



Description

20-448-06 Set of 6 dilators 20-440-10 - 20-440-20 (Ø 4.5/5.0 - 9.5/10.0 mm) in canvas case



Fig.	Ø mm	Pratt
13/15	4.5/5.0	20-460-15
17/19	5.6/6.3	20-460-19
21/23	7.0/7.6	20-460-23
25/27	8.3/9.0	20-460-27
29/31	9.6/10.3	20-460-31
33/35	11.0/11.6	20-460-35
37/39	12.3/13.0	20-460-39
41/43	13.6/14.3	20-460-43

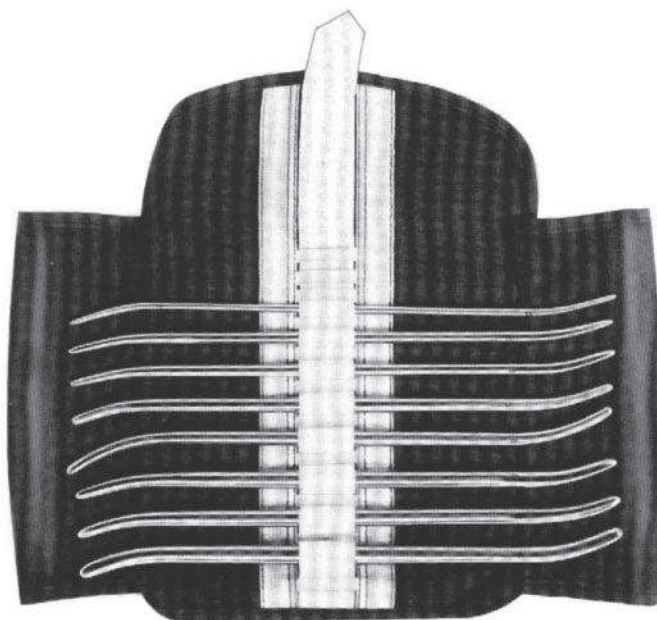

Description

20-468-08 Set of 8 dilators 20-460-15 - 20-460-43 (Ø 4.5/5.0 - 13.6/14.3 mm) in canvas case



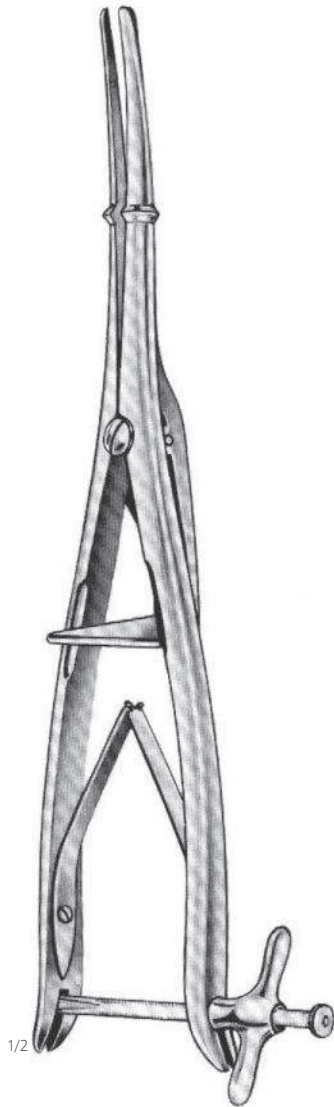

Cusco
20-490-29
29 cm

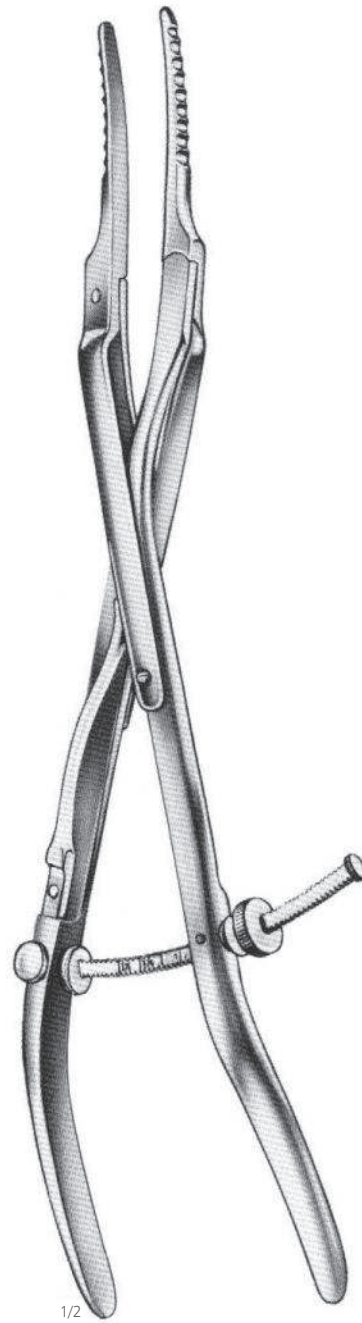

Goodell
20-494-37
34 cm

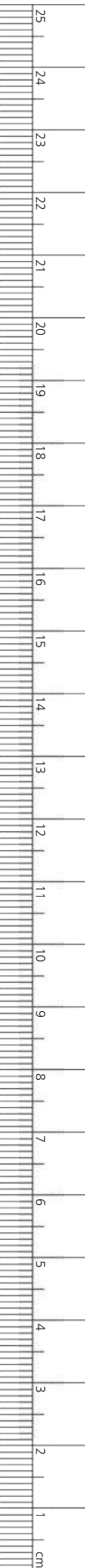



1/2

Amann
 20-518-32
 32 cm



1/2

Braun
 20-521-28
 28 cm



1/2

Sims
 20-523-26
 26 cm

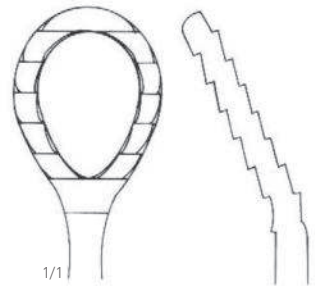

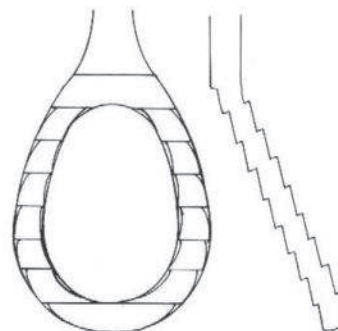

1/1



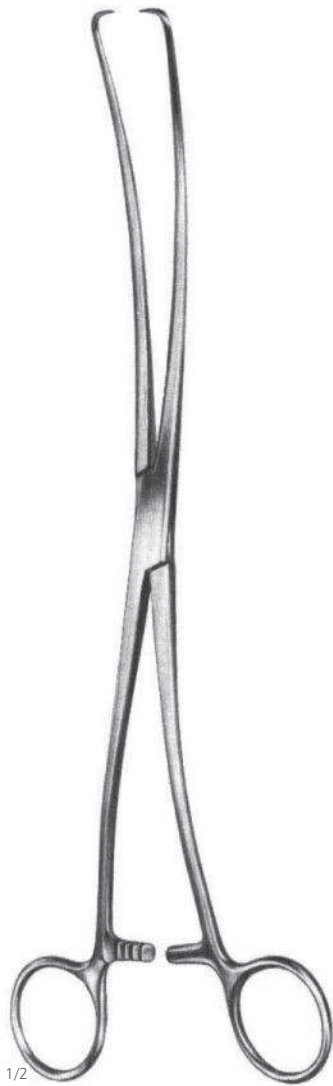





Duplay
20-551-28  
28 cm



Skene
20-559-24  
24 cm

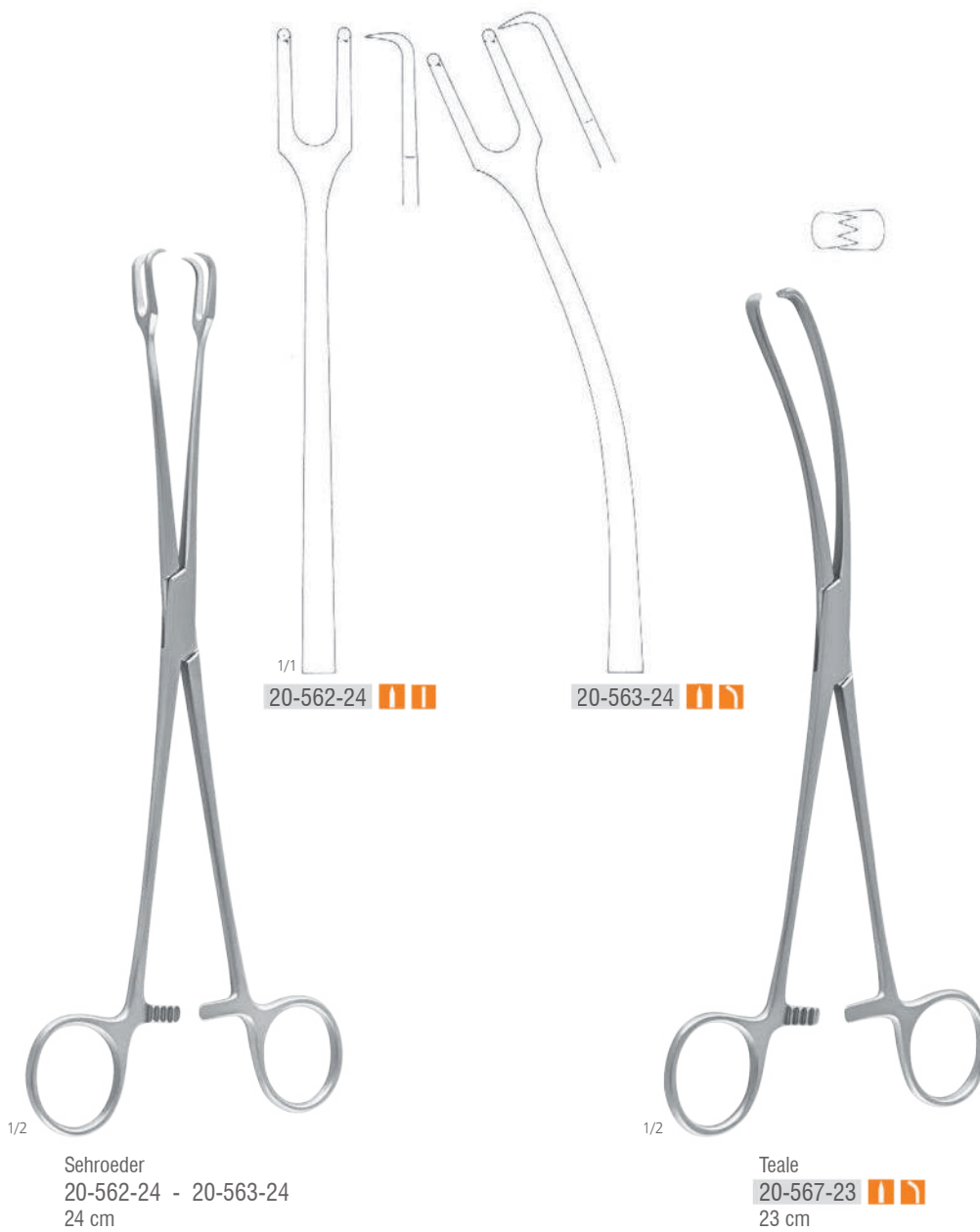



Barrett
20-570-18 
18 cm



Jacobs
20-572-21 
21 cm



Jacobs
20-573-21 
21 cm



Museux
20-576-06 - 20-576-10
24 cm

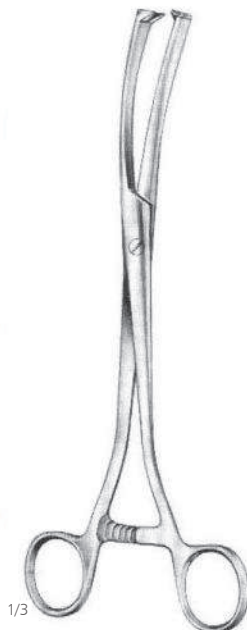

Museux
20-577-06 - 20-577-10
24 cm



Sairges
20-579-23
23 cm

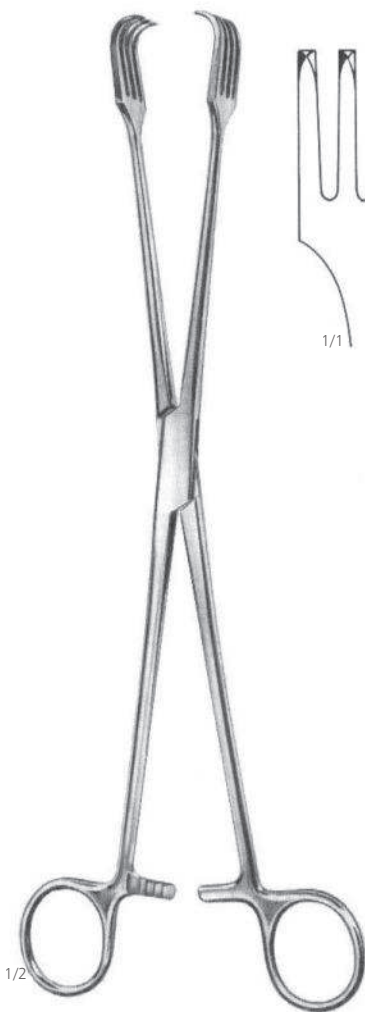
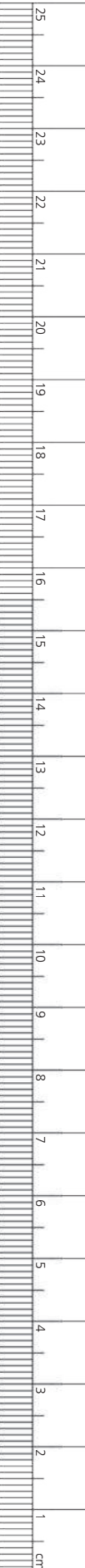

20-590-26 
26 cm



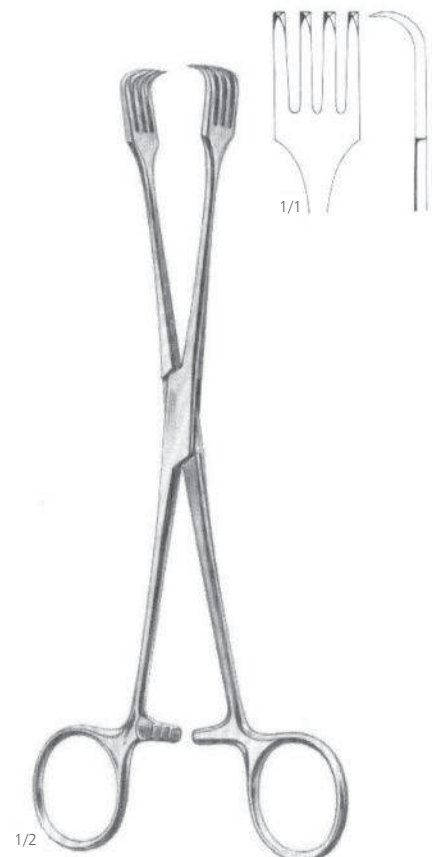

Braun
20-594-15 
15.5 cm

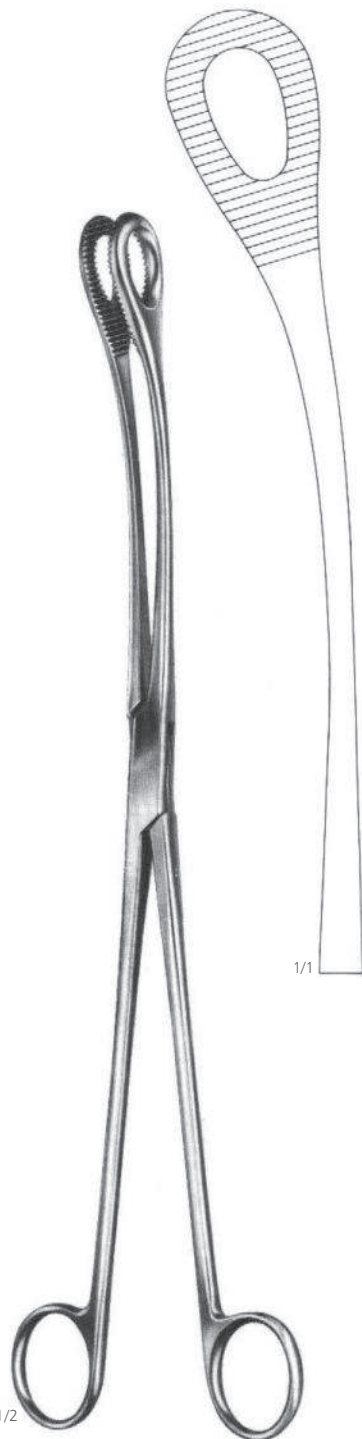

Czerny
20-598-20 
20.5 cm

Uterine Polypus Forceps
Uterus - Polypenzangen
Pinzas para polipos uterinos
Forceps utérin de polypes



Kelly
20-601-32 
32 cm

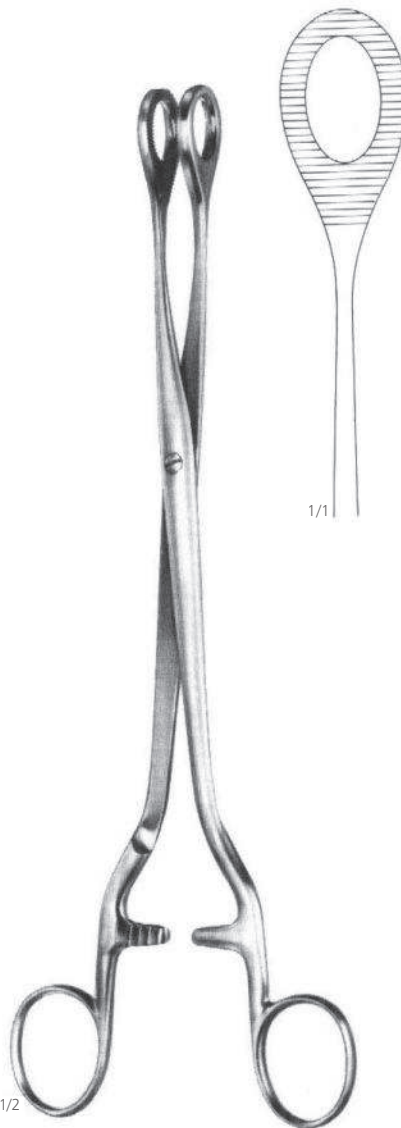

Noto
20-604-27 
27 cm

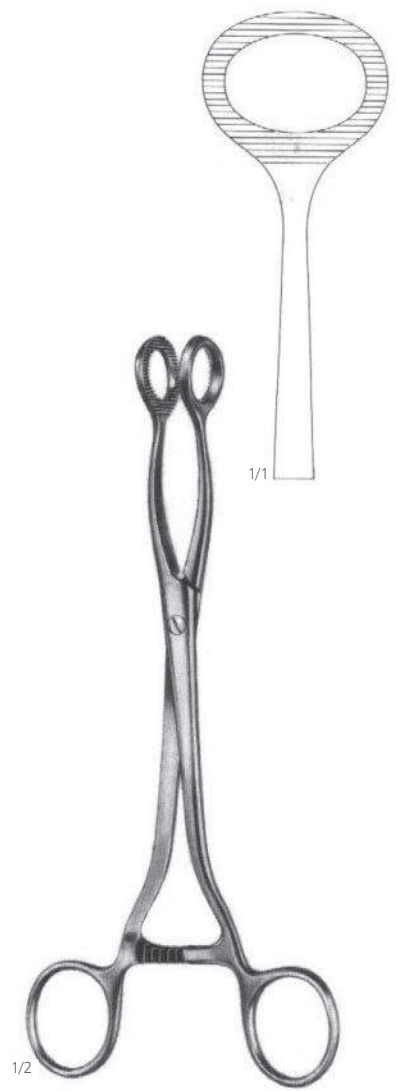

Doyen
20-608-20 
20 cm

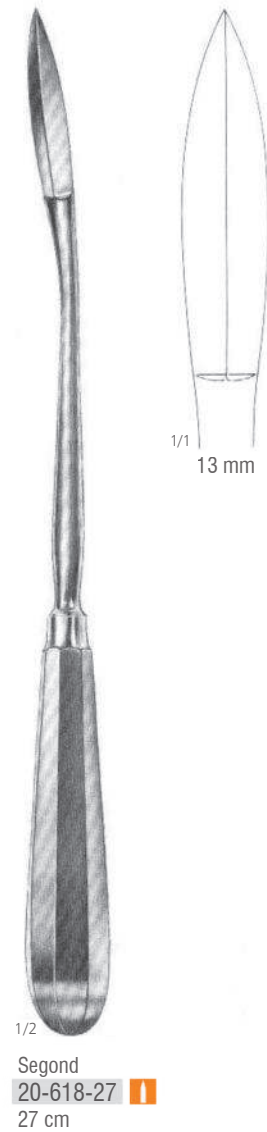
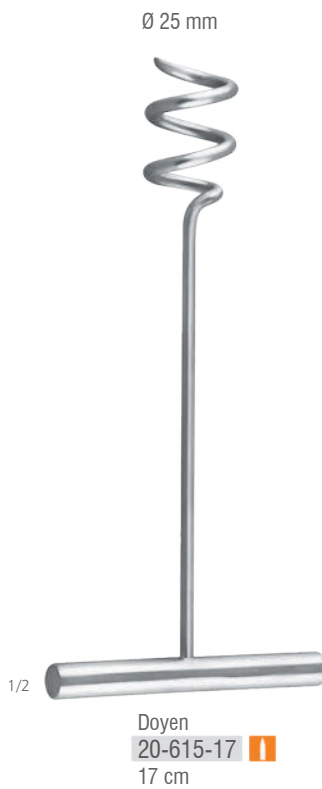





1/2

Emmet
20-650-01 - 20-650-05
22 cm



1/1

20-650-01



1/1

20-650-02



1/1

20-650-03



1/1

20-650-04



1/1

20-650-05



1/1

6.3 mm



1/2

Ayre
20-653-23
23 cm



1/2

Simon
20-656-01
22 cm



1/2

Simon
20-656-02
22 cm

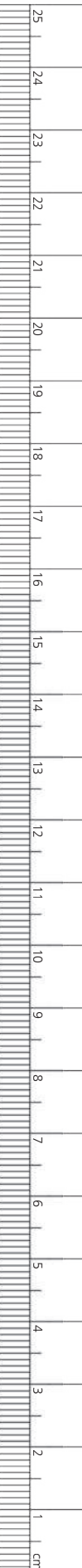

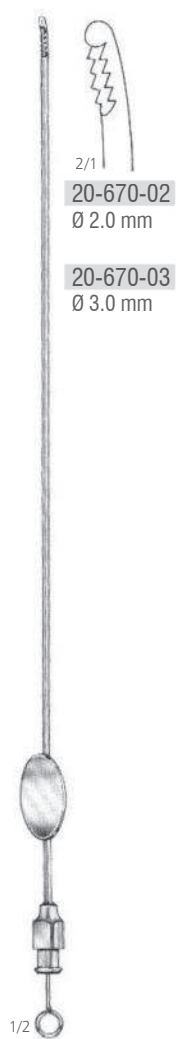

20-670-02
 Ø 2.0 mm

20-670-03
 Ø 3.0 mm

Novak
 20-670-02 - 20-670-03
 23 cm

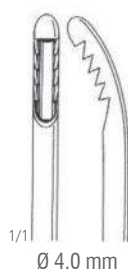

1/1
 Ø 4.0 mm

1/2
 Novak
 20-674-04
 23 cm



1/1
 Ø 4.80 mm

1/2
 Mod. Muenchen
 20-678-27
 27 cm

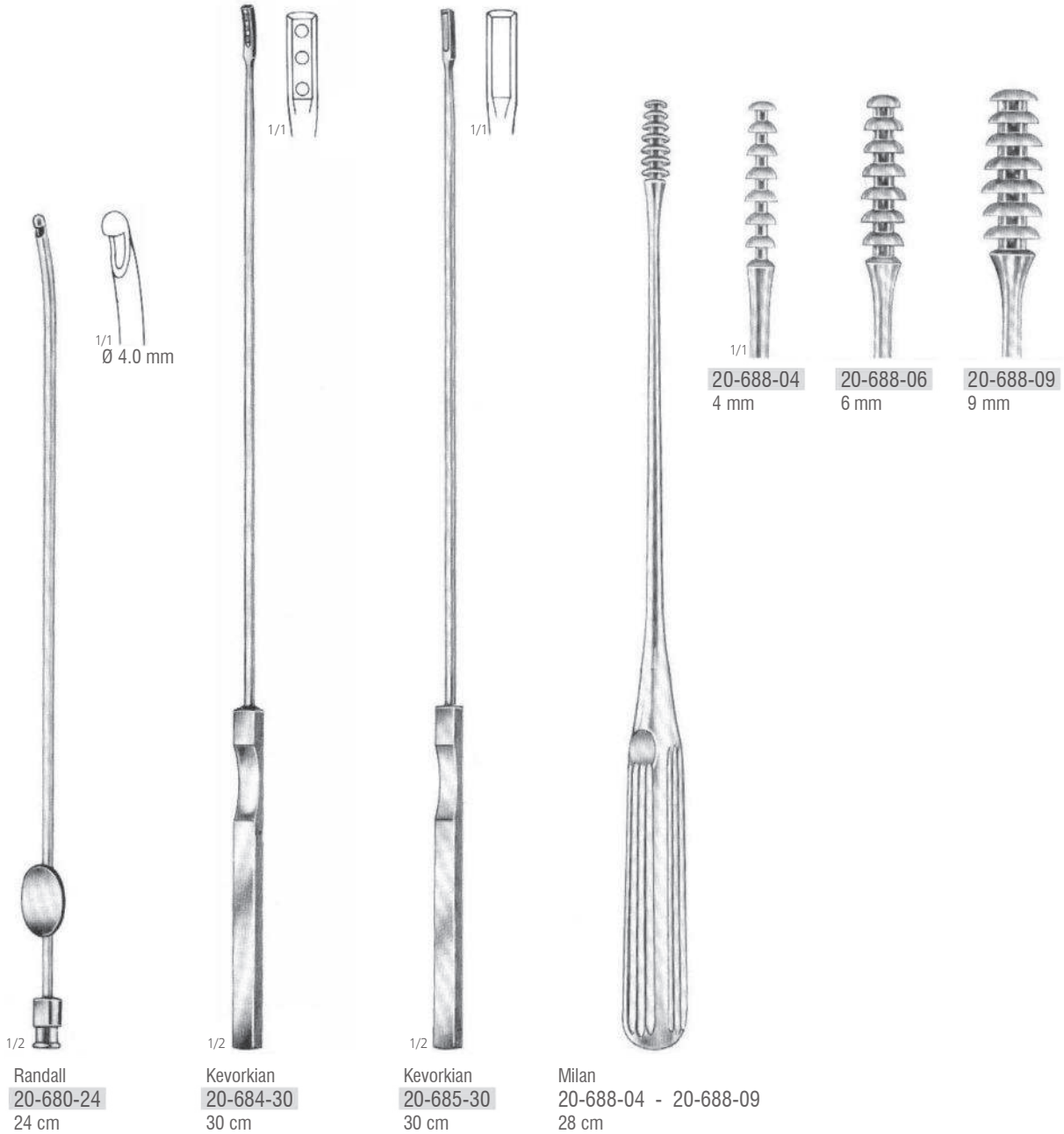

Specimen and
Aspirating Curettes

Aspirating Curettes

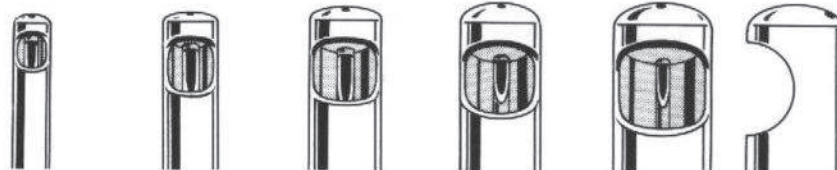

20-700-03
Ø 3 mm

20-700-04
Ø 4.5 mm

20-700-06
Ø 6 mm

20-700-08
Ø 8 mm

20-700-10
Ø 10 mm

20-700-12
Ø 12 mm

20-700-14
Ø 14 mm

20-700-50

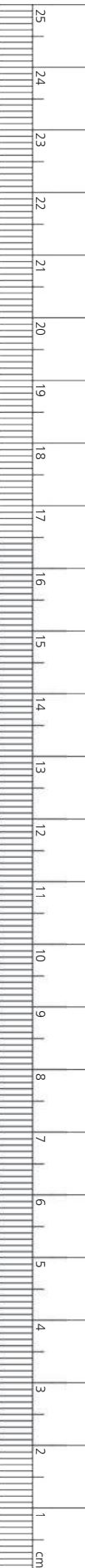

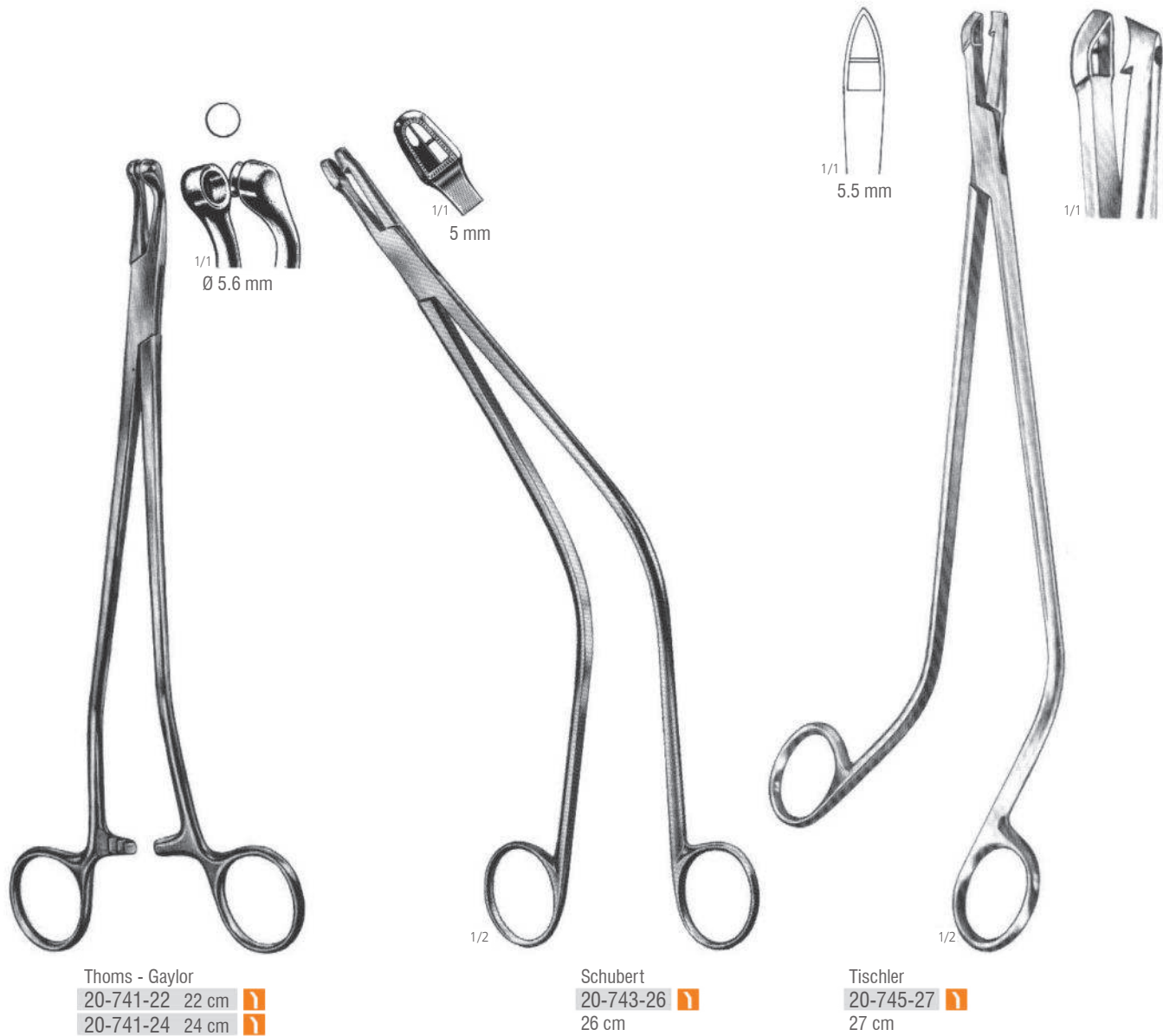



Fig. 1
 20-751-01 5 mm

1/1
 Fig. 2
 20-751-02 7 mm

Schumacher - Van Doren
 20-751-01 - 20-751-02
 24 cm



1/1
 4.9 mm

Van Doren
 20-753-25 25 cm



1/1
 4.9 mm

Van Doren
 20-755-25 25 cm

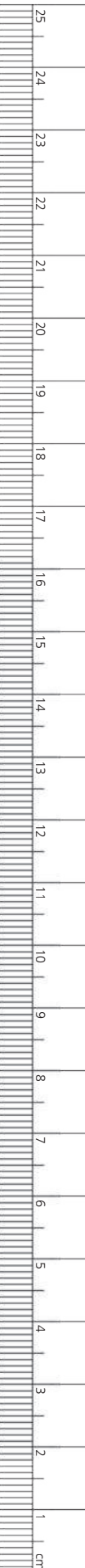

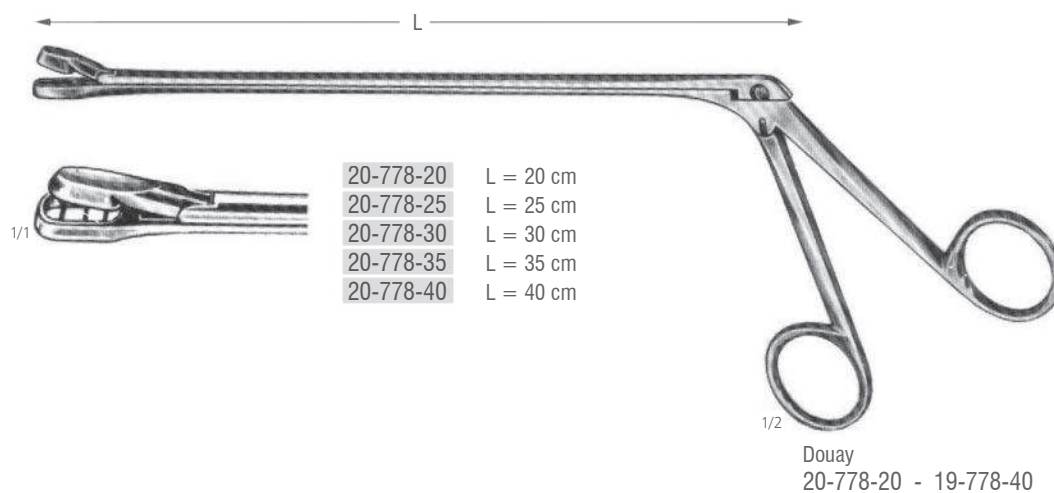
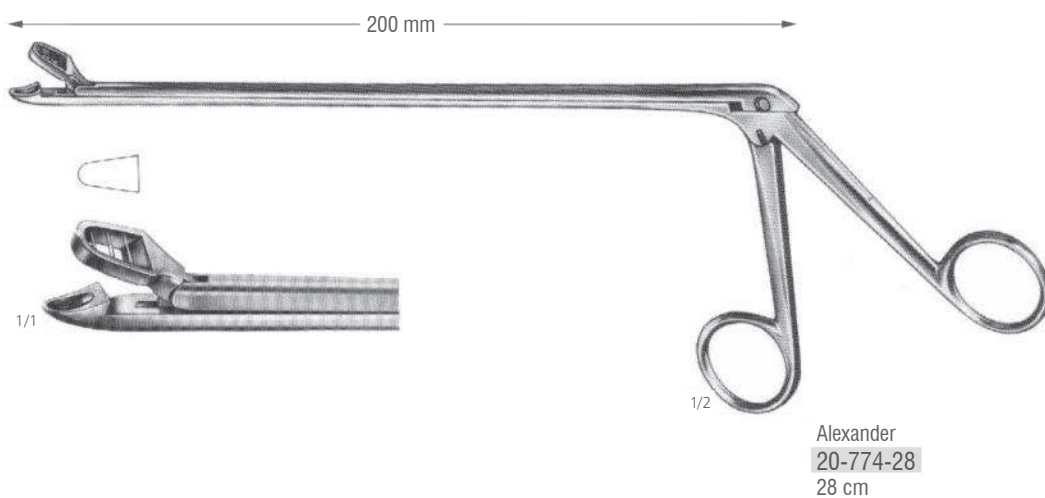
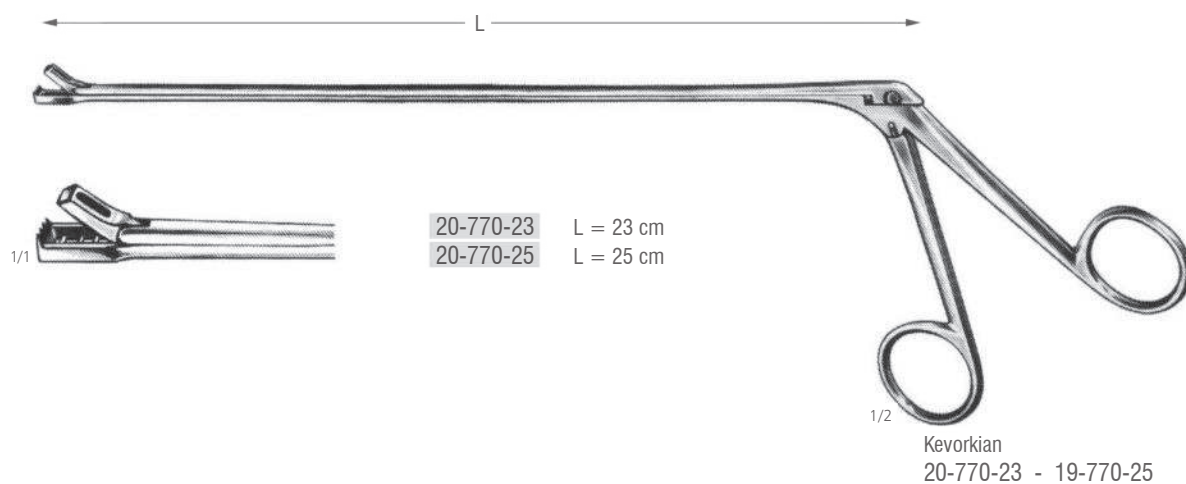

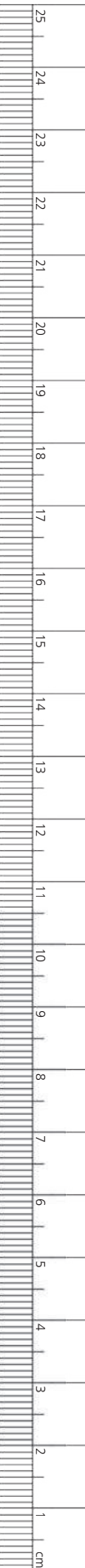
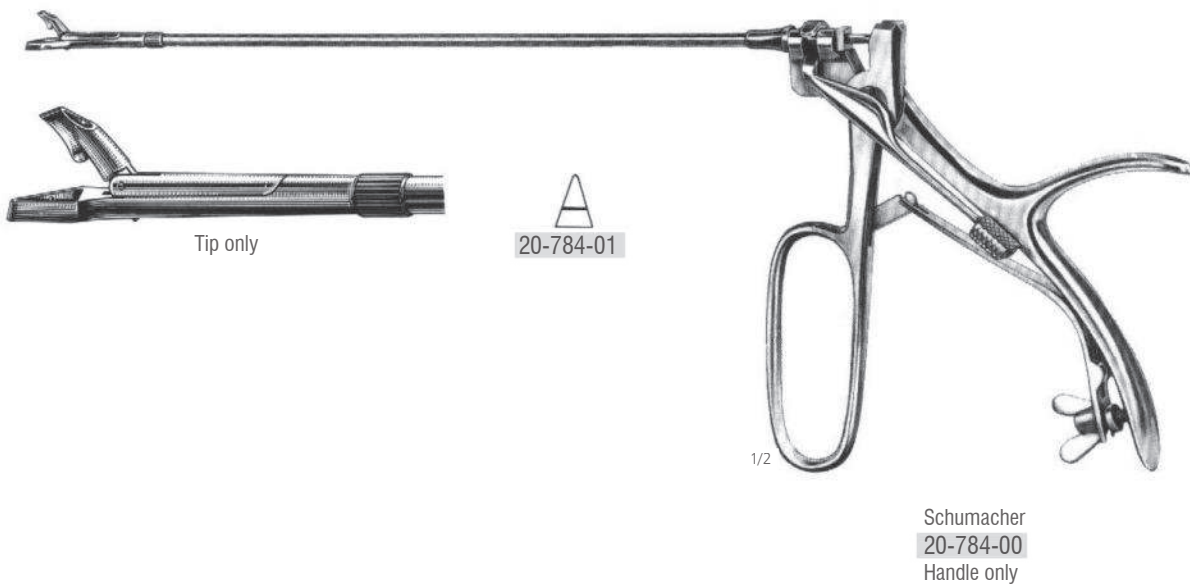
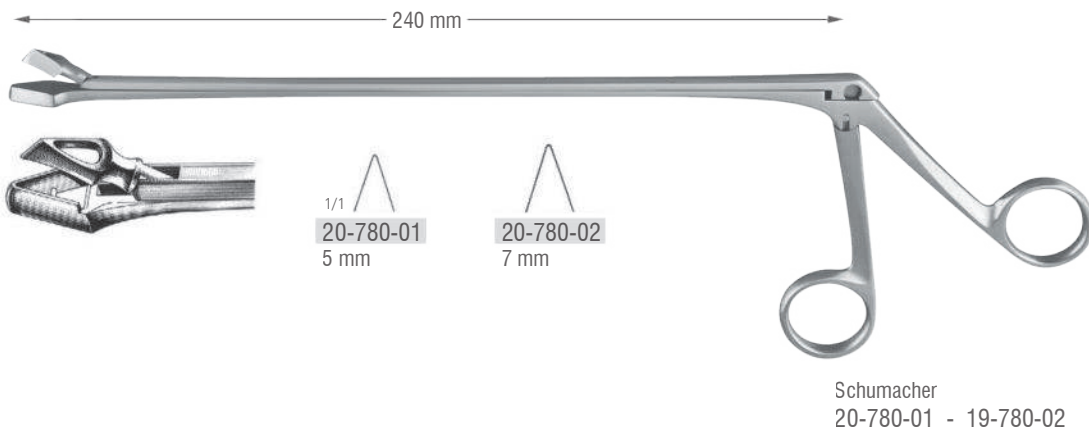

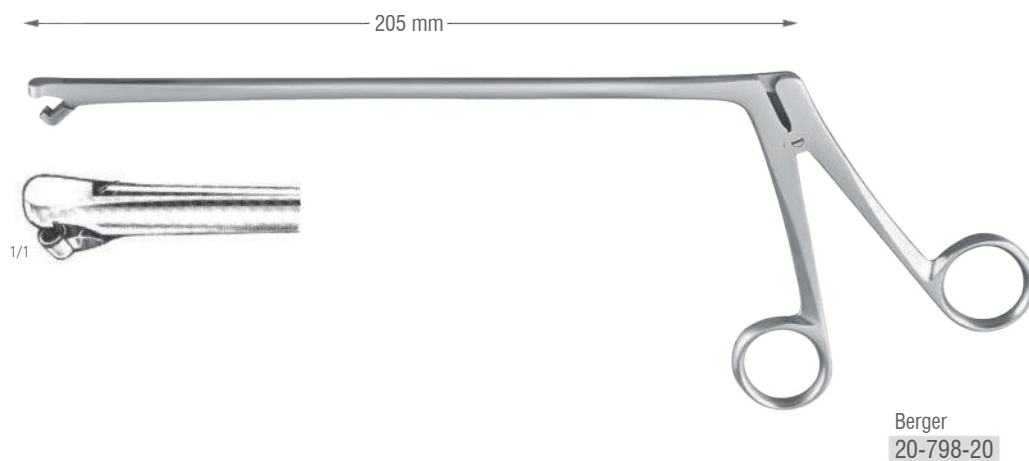
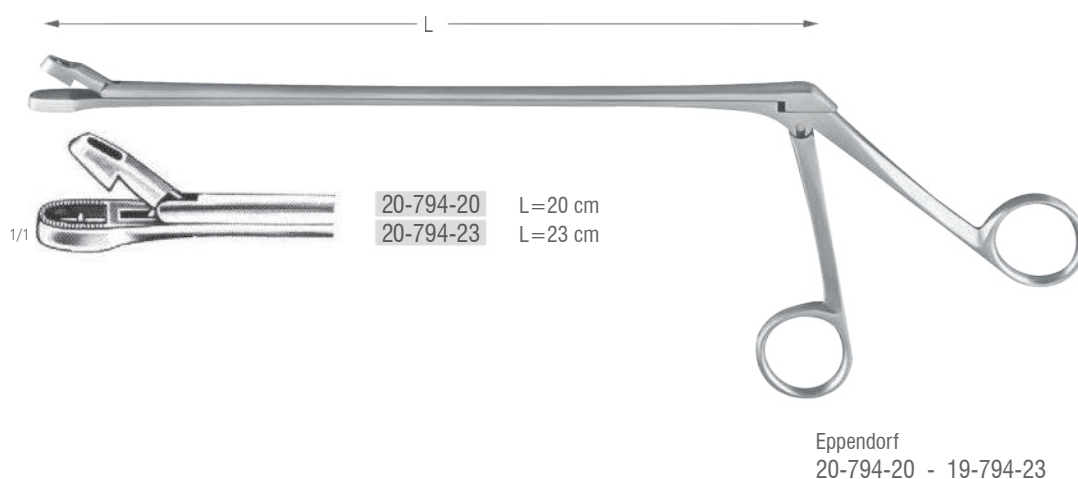
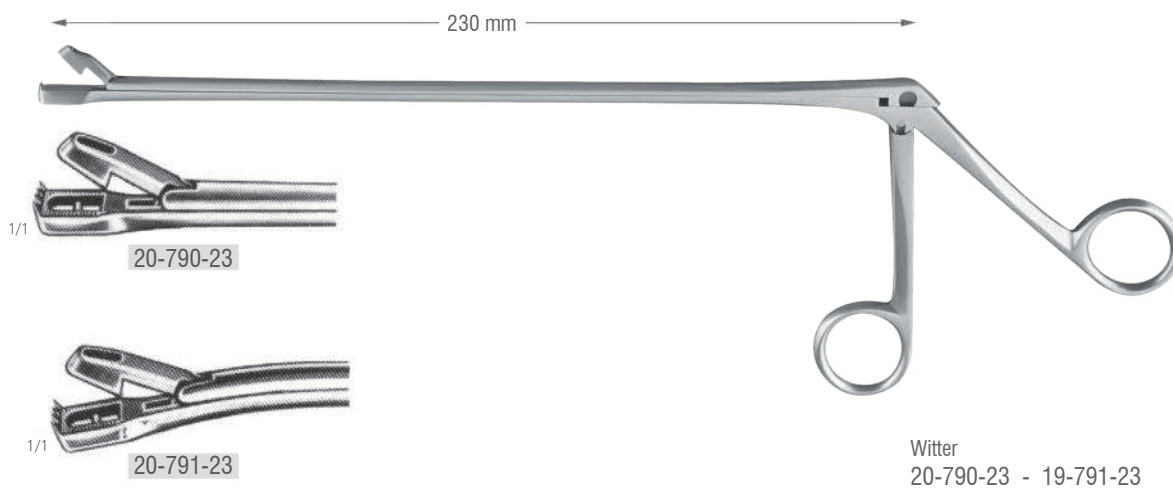

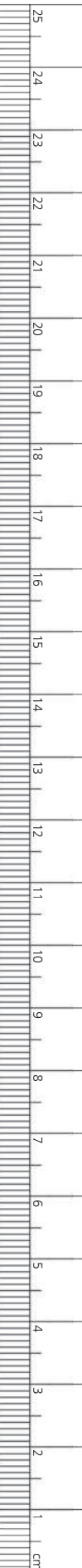
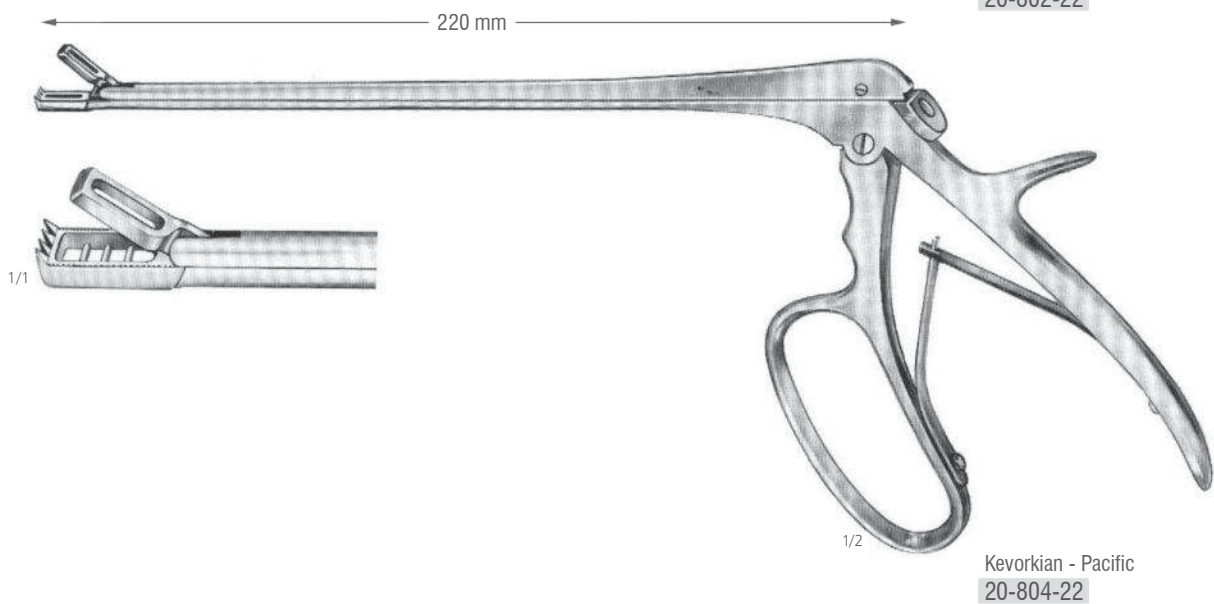
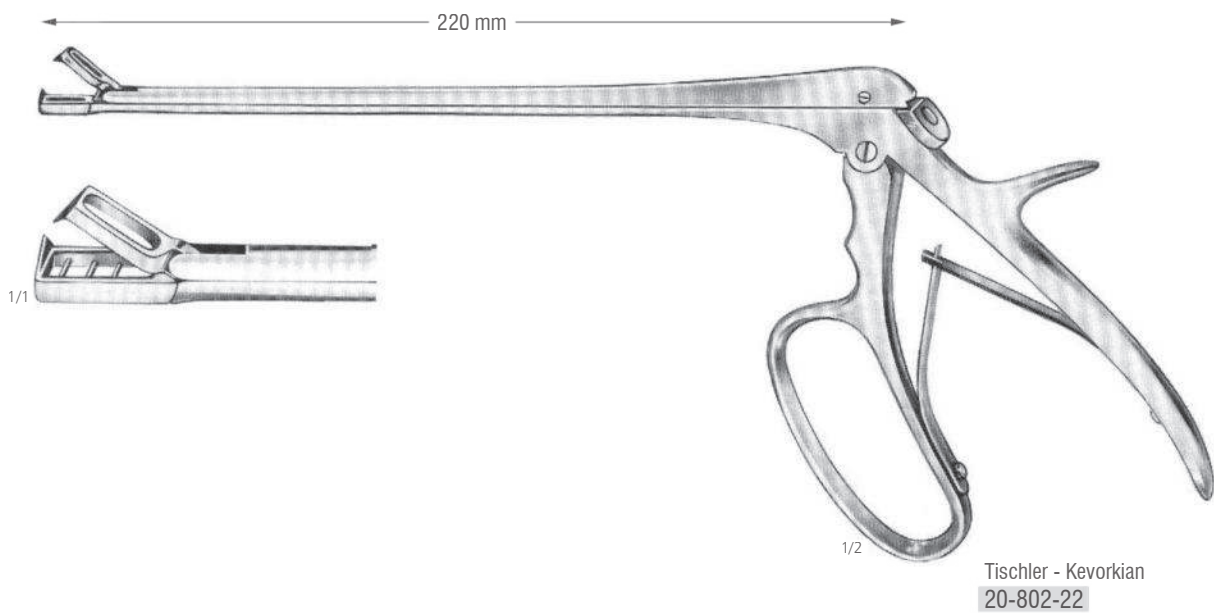
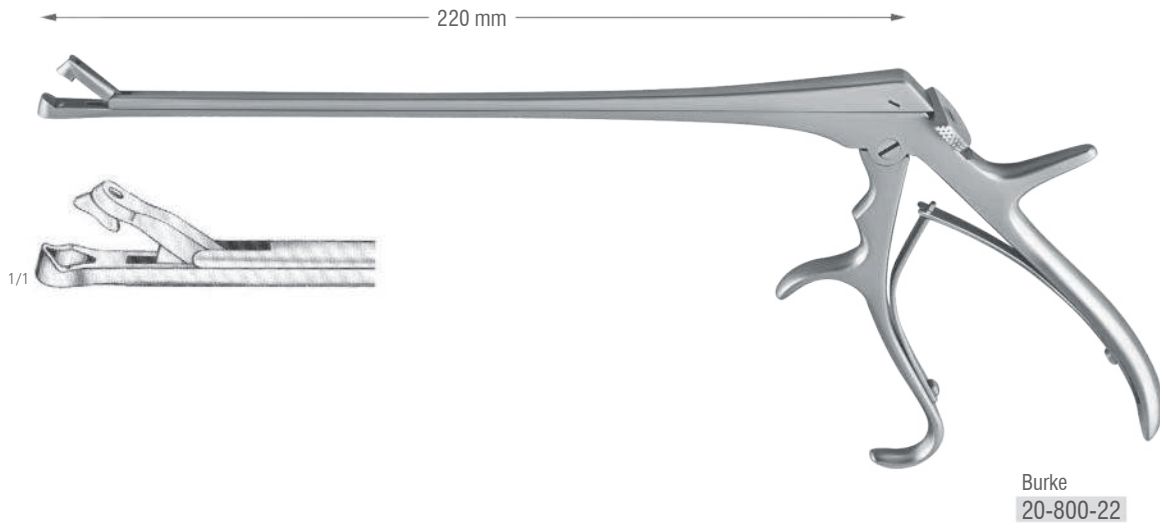

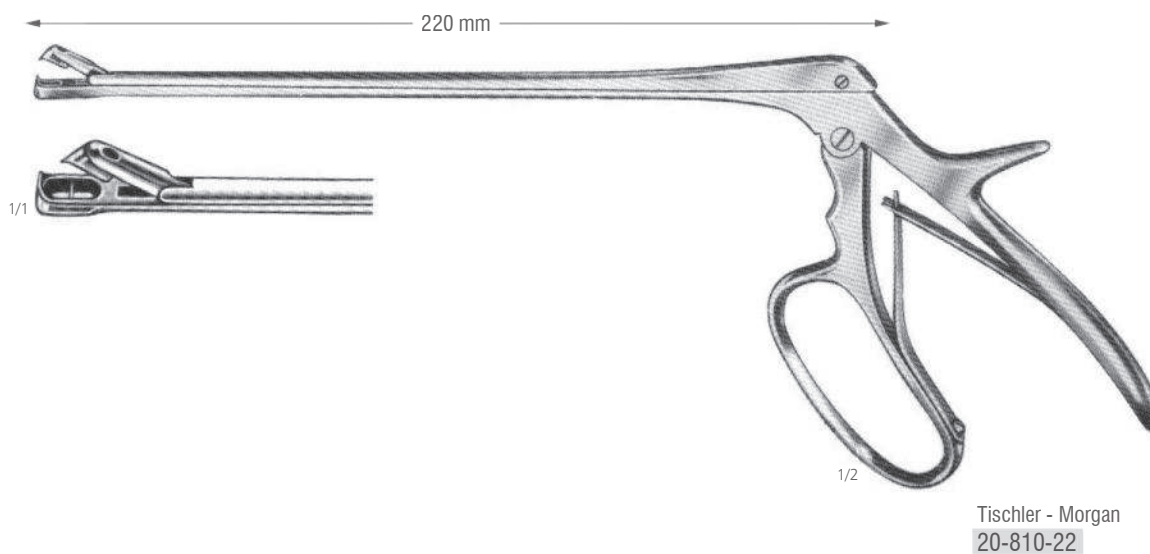
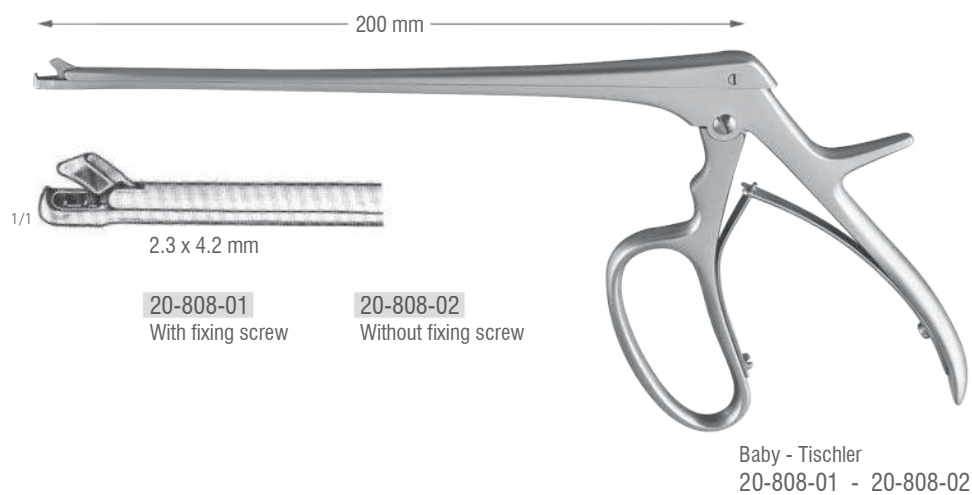
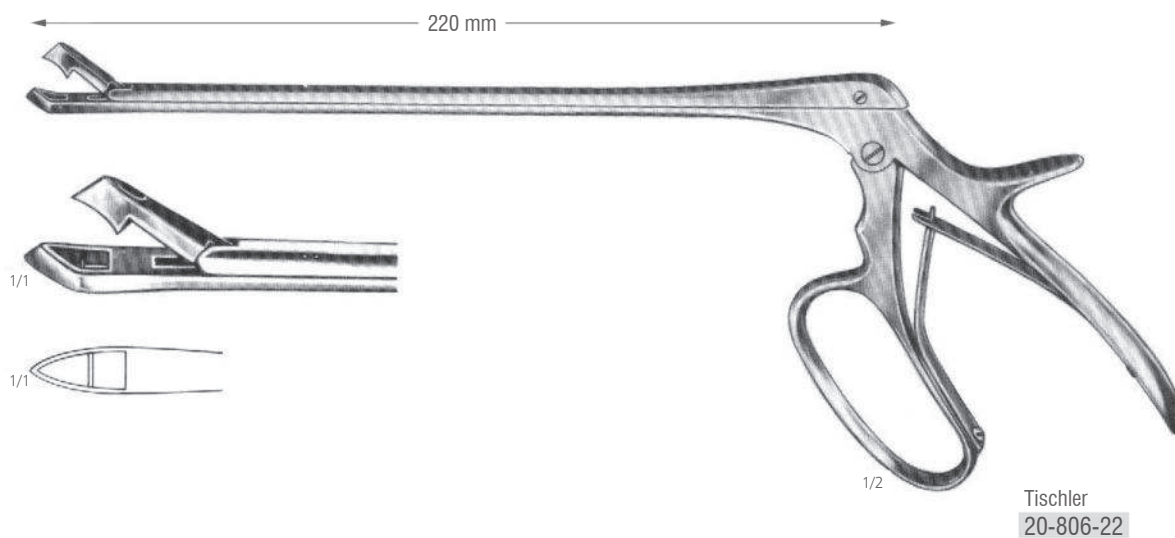

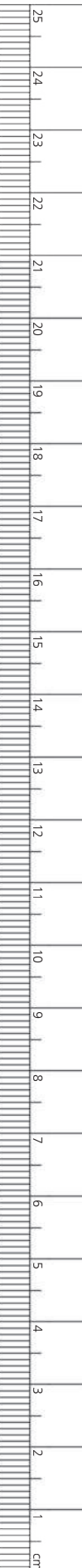
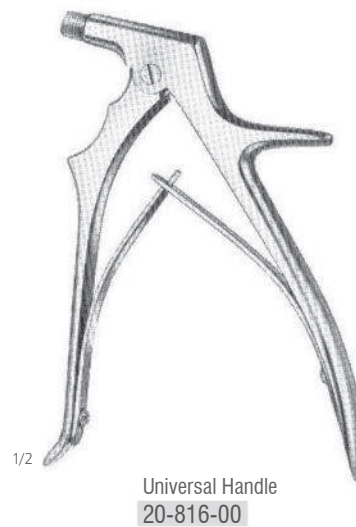
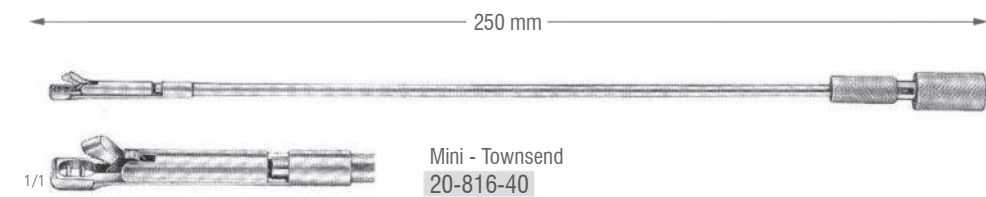
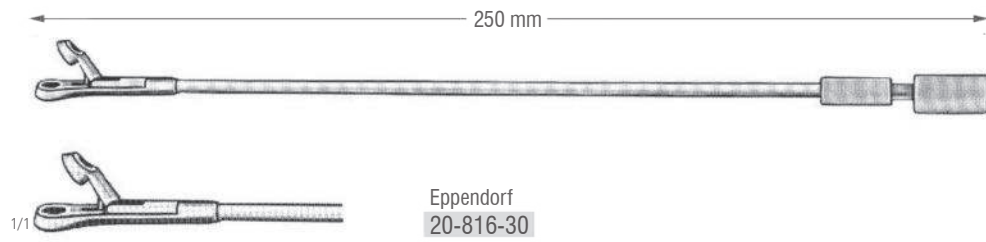
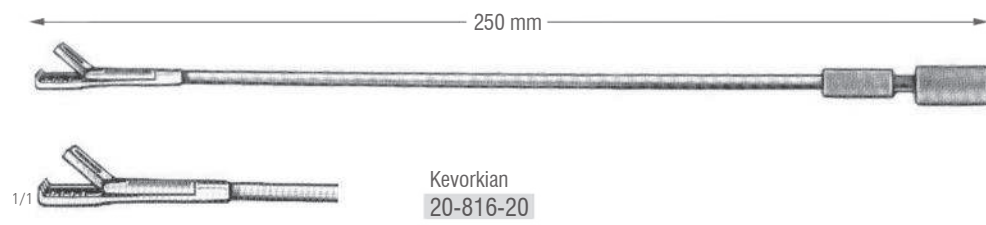
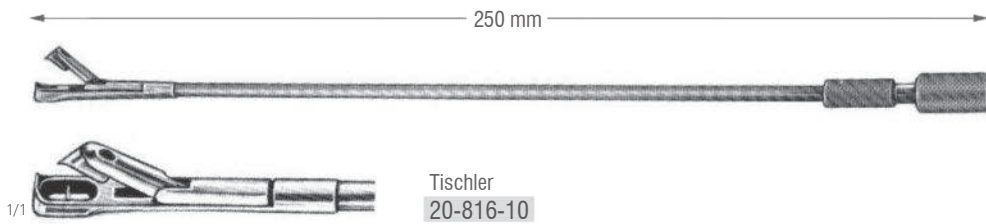

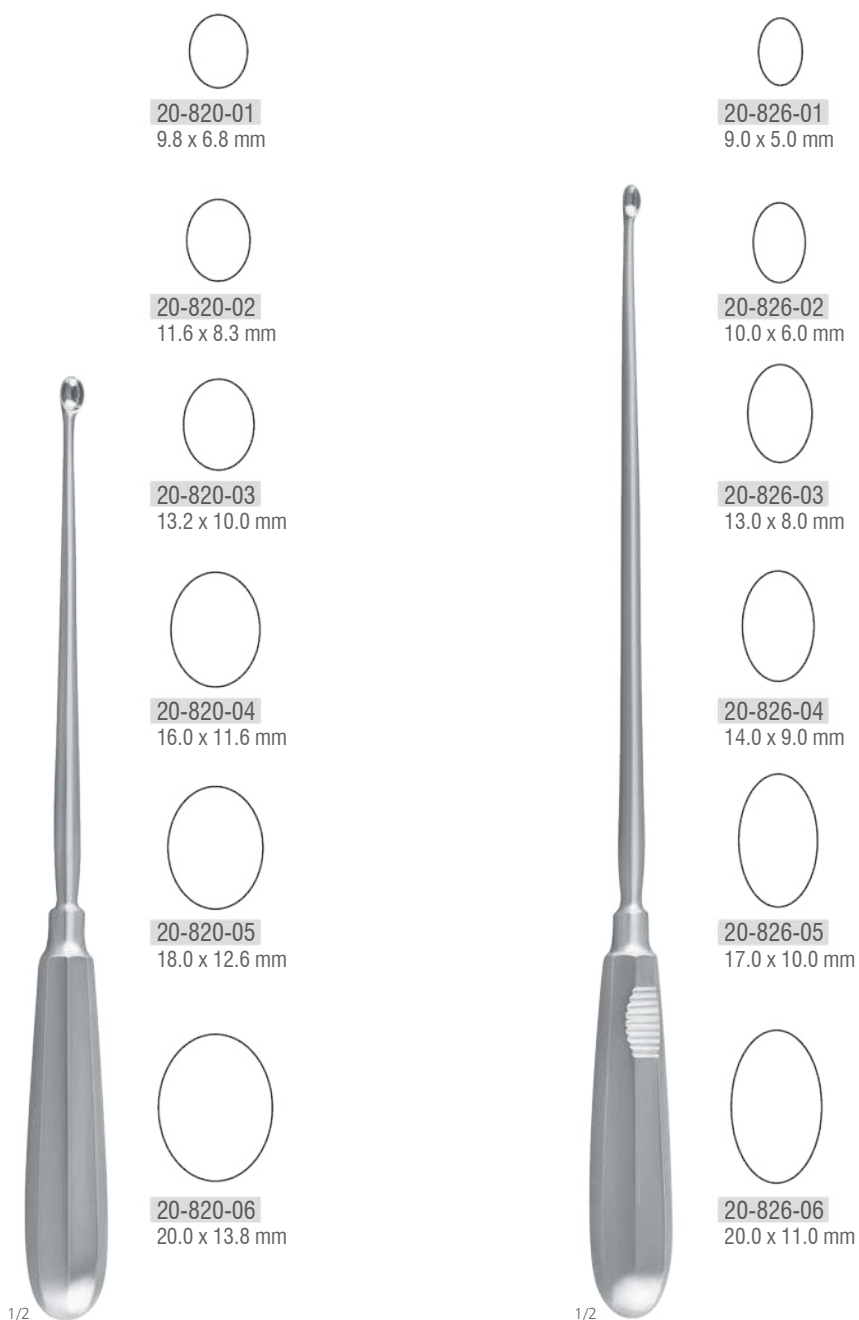

Simon
 20-820-01 - 20-820-06
 25 cm
 Sharp, rigid

Schroeder
 20-826-01 - 20-826-06
 30 cm
 Sharp, rigid



1/2
 Gourdet
 20-830-01 - 20-830-05
 28 cm



Fig. 1
 20-830-01



Fig. 2
 20-830-02



Fig. 3
 20-830-03



Fig. 4
 20-830-04



1/1
 Fig. 5
 20-830-05

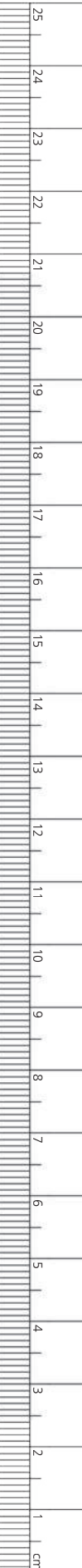



		Recamier	Recamier	Recamier	Recamier
Fig. 00	5 mm	20-850-05	20-851-05	20-854-05	20-855-05
Fig. 0	6 mm	20-850-06	20-851-06	20-854-06	20-855-06
Fig. 1	7 mm	20-850-07	20-851-07	20-854-07	20-855-07
Fig. 2	8 mm	20-850-08	20-851-08	20-854-08	20-855-08
Fig. 3	9 mm	20-850-09	20-851-09	20-854-09	20-855-09
Fig. 4	11 mm	20-850-11	20-851-11	20-854-11	20-855-11
Fig. 5	12 mm	20-850-12	20-851-12	20-854-12	20-855-12
Fig. 6	14 mm	20-850-14	20-851-14	20-854-14	20-855-14
Fig. 7	15 mm	20-850-15	20-851-15	20-854-15	20-855-15
Fig. 8	16 mm	20-850-16	20-851-16	20-854-16	20-855-16
Fig. 9	19 mm	20-850-19	20-851-19	20-854-19	20-855-19
Fig. 10	20 mm	20-850-20	20-851-20	20-854-20	20-855-20
Fig. 11	21 mm	20-850-21	20-851-21	20-854-21	20-855-21
Fig. 12	23 mm	20-850-23	20-851-23	20-854-23	20-855-23
Fig. 13	25 mm	20-850-25	20-851-25	20-854-25	20-855-25
Fig. 14	30 mm	20-850-30	20-851-30	20-854-30	20-855-30
Fig. 15	35 mm	20-850-35	20-851-35	20-854-35	20-855-35
Fig. 16	40 mm	20-850-40	20-851-40	20-854-40	20-855-40
		31 cm	31 cm	31 cm	31 cm

Sharp, rigid



Sharp, malleable



Blunt, rigid



Blunt, malleable



		Sims	Sims	Sims	Sims
Fig. 00	5 mm	20-860-05	20-861-05	20-864-05	20-865-05
Fig. 0	6 mm	20-860-06	20-861-06	20-864-06	20-865-06
Fig. 1	7 mm	20-860-07	20-861-07	20-864-07	20-865-07
Fig. 2	8 mm	20-860-08	20-861-08	20-864-08	20-865-08
Fig. 3	9 mm	20-860-09	20-861-09	20-864-09	20-865-09
Fig. 4	11 mm	20-860-11	20-861-11	20-864-11	20-865-11
Fig. 5	12 mm	20-860-12	20-861-12	20-864-12	20-865-12
Fig. 6	14 mm	20-860-14	20-861-14	20-864-14	20-865-14
Fig. 7	15 mm	20-860-15	20-861-15	20-864-15	20-865-15
Fig. 8	16 mm	20-860-16	20-861-16	20-864-16	20-865-16
Fig. 9	19 mm	20-860-19	20-861-19	20-864-19	20-865-19
Fig. 10	20 mm	20-860-20	20-861-20	20-864-20	20-865-20
Fig. 11	21 mm	20-860-21	20-861-21	20-864-21	20-865-21
Fig. 12	23 mm	20-860-23	20-861-23	20-864-23	20-865-23
Fig. 13	25 mm	20-860-25	20-861-25	20-864-25	20-865-25
Fig. 14	30 mm	20-860-30	20-861-30	20-864-30	20-865-30
Fig. 15	35 mm	20-860-35	20-861-35	20-864-35	20-865-35
Fig. 16	40 mm	20-860-40	20-861-40	20-864-40	20-865-40
		26 cm	26 cm	26 cm	26 cm

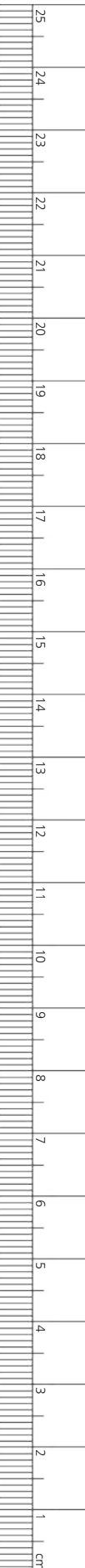

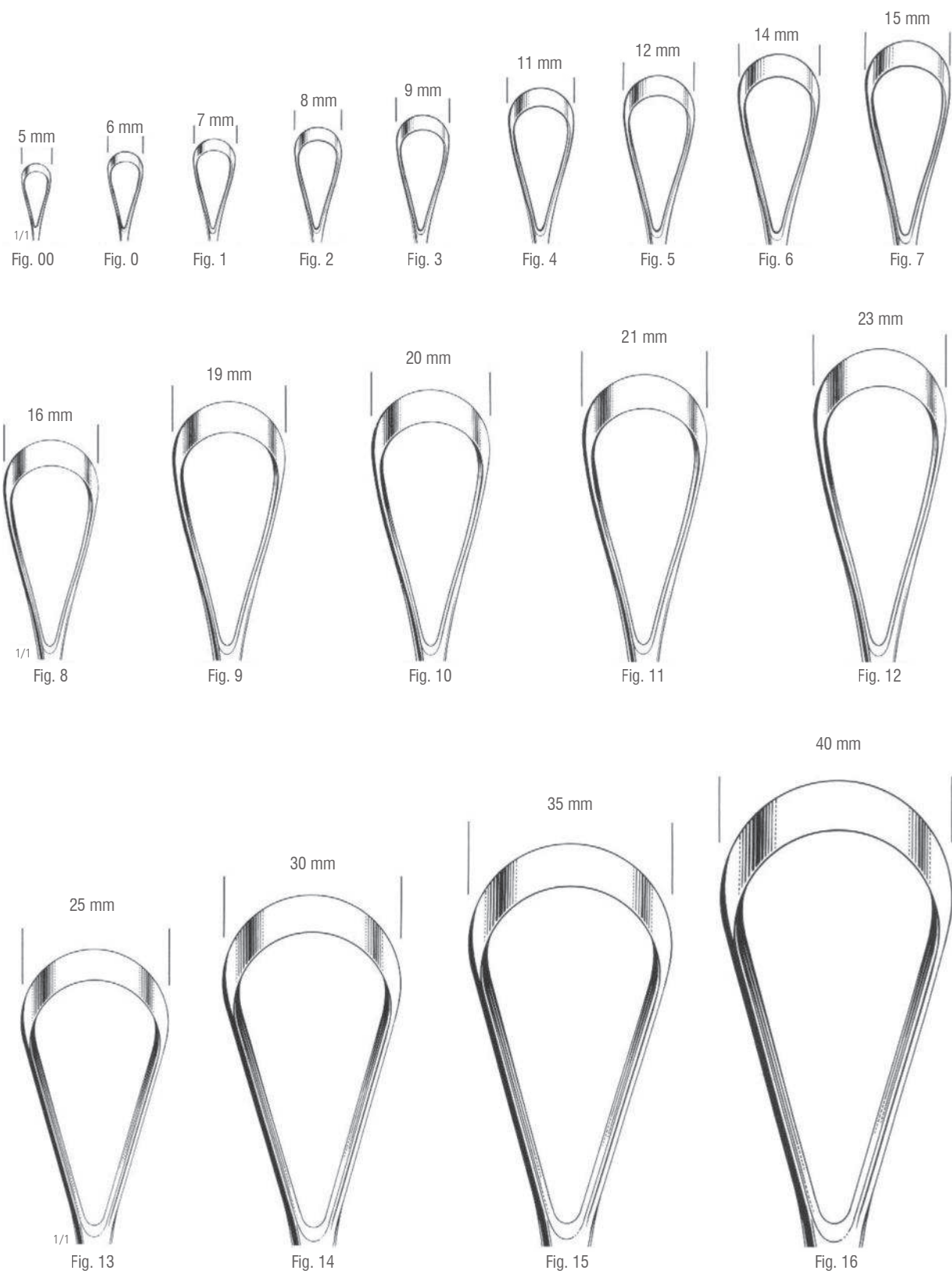



Collin
 20-880-08 - 20-880-14
 28 cm



20-880-08
 8 mm

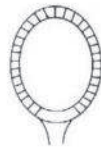

20-880-10
 10 mm

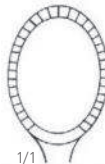

20-880-12
 12 mm



20-880-14
 14 mm



Blake
 20-882-27
 27 cm

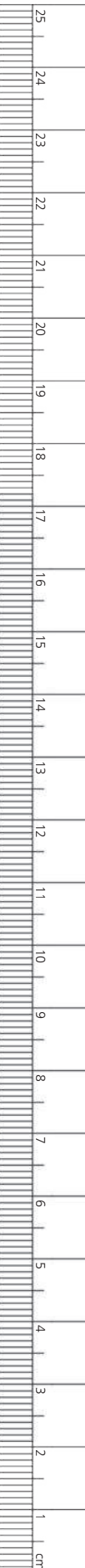

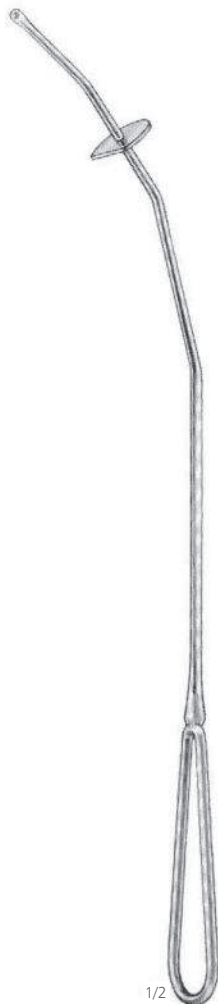



Ramathibodi
20-890-27
27.5 cm
Uterine manipulator

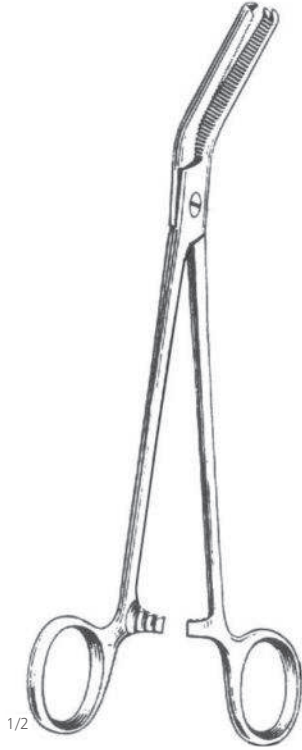

Ramathibodi
20-892-25
25 cm
Tubal hook



1/2

Bonney - Berkeley
20-900-19 
19 cm

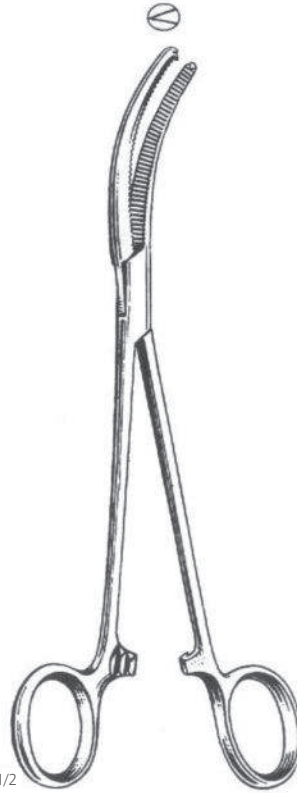



1/2

Bonney - Berkeley
20-902-19
19 cm



1/1

Maingot
20-906-20 20 cm 
20-906-24 24 cm 

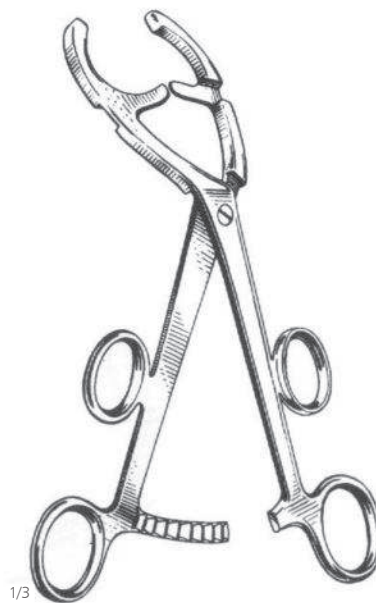

1/3

Bonney
20-908-25
25 cm

