

# ORTHOPAEDIC INSTRUMENTS

**EMPIRE MEDICAL LTD.  
UNITED KINGDOM**



**Empire**

- Hip Joint Instruments
- Revision Instruments
- Arthroscopy Instruments



## INTRODUCTION

Empire Medical UK is an established manufacturer of Surgical instruments. With our wide range we cover instruments for surgeries from head to toe.

We present our catalogue detailing our range of instrumentation for Orthopaedic Surgery.

These specialist Instruments are manufactured to the highest possible standards with the most modern processes and technology.

As a leader in the industry, Empire Medical Ltd has a wealth of knowledge and expertise that is incomparable. We utilize this experience to provide both companies and individuals with quality and innovative products they can truly count on.

In addition, we ensure that we stay ahead of the industry curve by using the latest technologies. Rest assured that no matter what you need, you can rely on us to provide the absolute best. Keep browsing through our site to learn more.

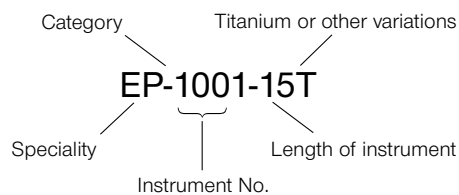

Empire Medical's factory in Middle East, where high standard manufacturing is done with strong quality and health control.

# Contents

01-09

Bone Levers



11-17

Bone Hooks

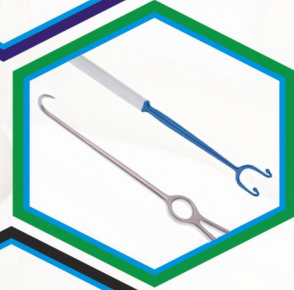

18-30

Retractors

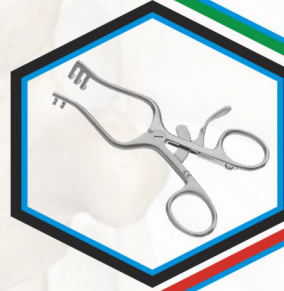

32-42  
46-47

Bone Holding Forceps



43-45

Pelvic Reduction Forceps

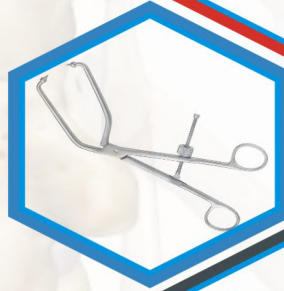

49-56

Tendon & Cartilage Instruments



57-58

Meniscus



60-79

Bone Currettes

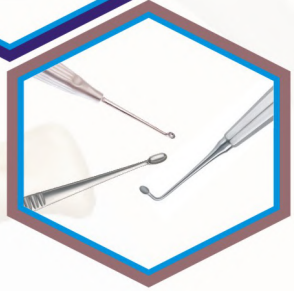

# Contents

81-93

Elevators & Raspatories



95-105

Chisels, Gouges & Osteotomes

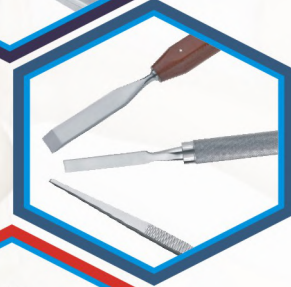

107-118

Mallets & Tamps



120-124

Files & Rasps

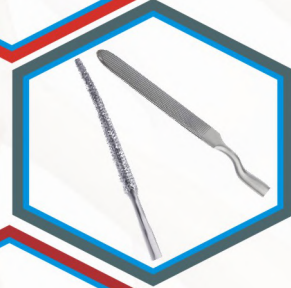

126-137

Bone Rongeurs

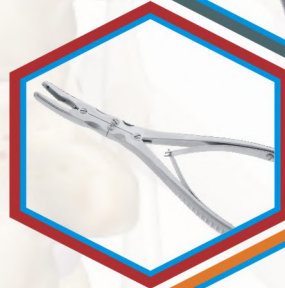

138

Bone Spreaders



140-144

Bone Cutters



146-155

Plaster Cast Instruments



# Contents

157-160

Amputation



162-165

Measuring Devices



167-172

Podiatry



174-188

Pliers & Wire Cutters



189-197

Wire Gripping & Bending



199-208

Drills, Saws & Awls

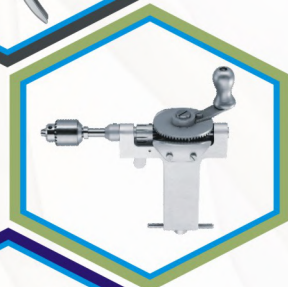

199-208

Miscellaneous





## BONE LEVERS

# BONE LEVERS



## Mini Bone Lever

- 14cm/5½"
- 2.8mm width

13-690-14



## Hohmann Style Mini-Bone Lever

- 16cm/6¼"

Width

13-693-06

6mm

13-693-08

8mm



## Phalangeal Lever

- 14cm/5½"
- 5mm width

13-691-14



## Buck-Gramcko Lever

- 15cm/6"
- 2mm/7.5mm width

13-690-15



## Mini-Cobra Bone Lever

- 16cm/6¼"

Width Length

13-693-15

15mm

16cm

13-693-16

16mm

12cm



## McGlamry Metatarsal Lever

- 17cm/6½"
- Sharp

Width

13-694-10

9mm

13-694-12

11mm

13-694-14

13mm

13-694-16

15mm

13-694-19

19mm



# BONE LEVERS



## Hohmann Bone Lever

- 22cm/8½" length
- 8mm width

13-695-08



## Hohmann Bone Lever

- 24cm/9½" length
- 18mm width

13-695-18



## Hohmann Bone Lever

- 24.5cm/9½" length
- 43mm width

13-695-43



## Hohmann Large Bone Lever

- 25cm/9¾" length
- 70mm width

13-695-70



## Hohmann Bone Lever

- 29cm/11½" length
- 35mm width

13-705-35



## Hohmann Bone Lever

- 27.5cm/10¾" length
- 24mm width

13-707-24





# BONE LEVERS



## Hohmann Bone Lever

- 23.5cm/9" length
- 43mm width

13-701-43



## Hohmann Bone Lever

- 25.5cm/10" length
- 22mm width

13-703-22



## Hohmann Bone Lever

- 25cm/9¾" length
- 22mm width

13-709-22



## Lange-Hohmann Modif Lever

- 26.5cm/10½" length
- 30mm width

13-712-01



## Lange-Hohmann Modif Lever

- 29cm/11½" length
- 33mm width

13-712-02

## Hohmann-Aldinger Lever

- 27cm/10¾" length
- 24mm width

13-712-03



# BONE LEVERS

## Bennett Bone Lever

- 24cm/9½" length

|           | Width |
|-----------|-------|
| 13-711-43 | 43mm  |
| 13-711-60 | 60mm  |



## Blount Bone Lever

- 26cm/10¼" length

13-715-26



## Blount Bone Lever

- 26cm/10¼" length

13-717-26



## Schumacher-Wagner I

- 34.5cm/14" length
- 37mm width

13-712-04



## Schumacher Lever

- 29cm/11½" length
- 35mm width

13-712-05

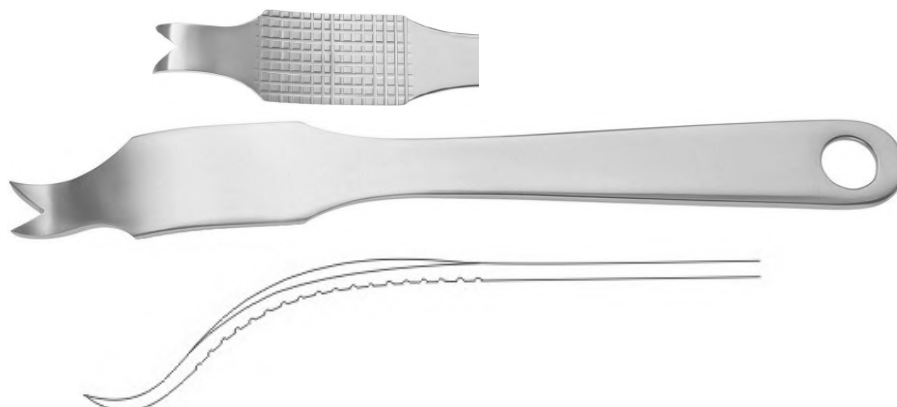

# BONE LEVERS



## Wagner Bone Lever

- 22cm/8½"
- 17mm width

13-713-06



## Chandler Bone Lever

- 16cm/6¼"

|           | Width | Length |
|-----------|-------|--------|
| 13-713-08 | 13mm  | 18cm   |
| 13-713-09 | 19mm  | 20cm   |
| 13-713-10 | 25mm  | 23cm   |
| 13-713-11 | 30mm  | 25cm   |

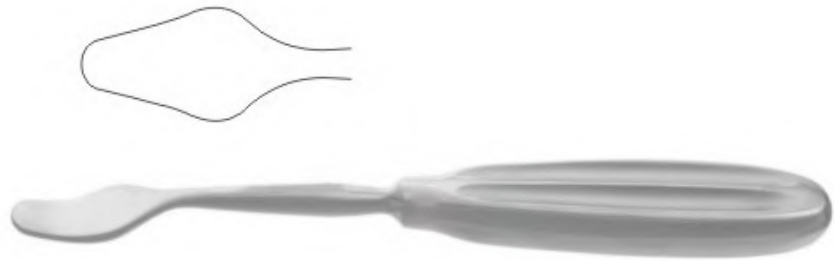

## Verbrugge - Muller Bone Lever

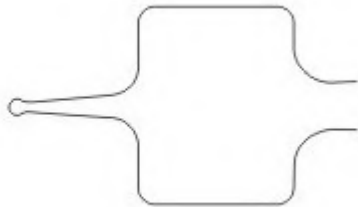

- 25.5cm/10" length
- 65mm width

13-714-02

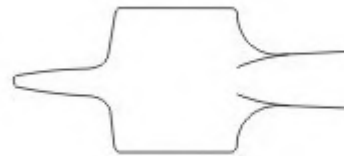

- 24cm/9½" length
- 42mm width

13-714-01

## Taylor Bone Lever

- 16.5cm/6½"

|           | Width      |
|-----------|------------|
| 13-694-10 | 100 x 30mm |
| 13-694-12 | 70 x 30mm  |



# BONE LEVERS



## Long Curved Hohmann Inferior Hip Elevator

- 40cm/16" length
- 22mm width

13-708-40



## Modified Hohmann Elevator

- 90° angled

|           | Width |
|-----------|-------|
| 13-710-10 | 10mm  |
| 13-710-18 | 18mm  |
| 13-710-25 | 25mm  |
| 13-710-43 | 43mm  |
| 13-710-70 | 70mm  |

## Modified Cobra Aufrang Elevator

- 33cm/13" long blade
- 30mm x 100mm

13-718-10



## Shallow Bone Elevator

- 25cm/9¾" length

13-719-25



## Concave Moor Elevator

- 33cm/13" long blade

13-720-20

# BONE LEVERS



## Murphy Bone Skid Elevator

- 23cm/9" length
- For dislocation of the femoral head
- Double ended

13-713-07



## Murphy Insulated Bone Skid Elevator

- 33cm/13" length
- Double ended

13-713-33



## Infero-Posterior Acetabular Capsule Retractor

- 35cm/14" length

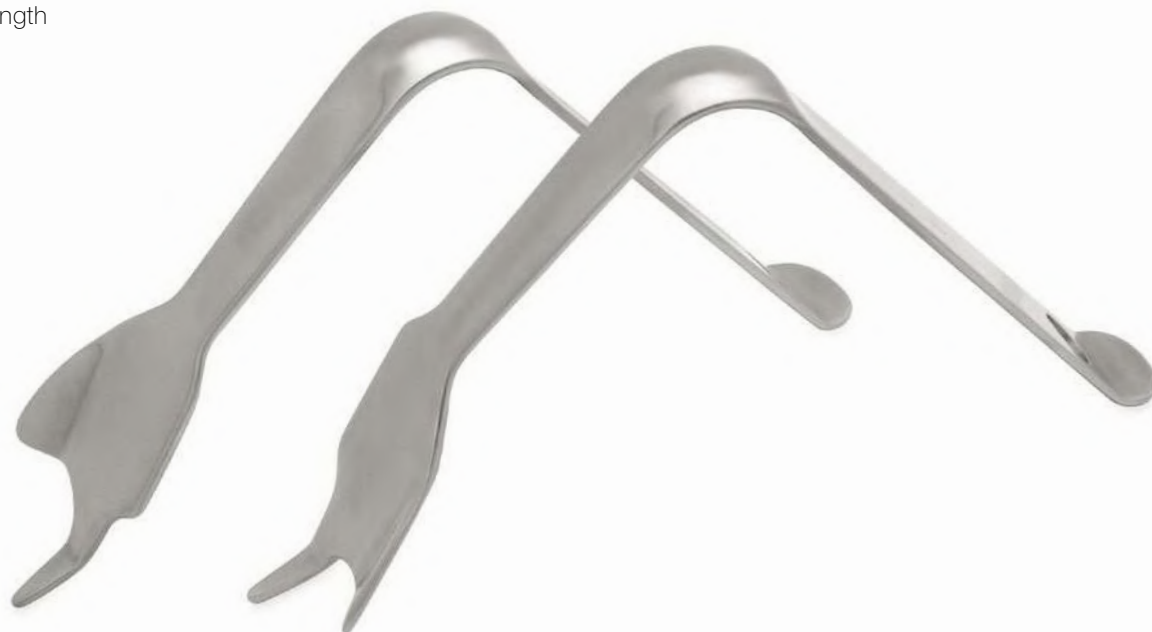

## PCL Retractor

- 25cm/10" length
- To straddle the cruciate ligament
- 4mm wide prongs
- 21mm wide tips

13-704-21



## Wide Prong PCL Retractor

- 25cm/10" length
- To straddle the cruciate ligament
- 5mm wide prongs
- 23mm wide tips

13-704-23



# BONE LEVERS

## Trethowan Bone Lever

- 21.5cm/8½" length

13-714-21



## Lanes Bone Lever

- 25.5cm/10" length

13-714-25



## Fagge Bone Lever

- 27.5cm/10¾" length

13-716-27



## Bristow Periosteal Lever

- 23cm/9" length
- Curved sharp
- 10mm width

13-718-23



## Femoral Dislocation Lever

- 31cm/12½" length
- 26mm width

13-719-31



## Muller Femoral Retractor

- 35cm/13½" length
- 28mm width

13-720-35



For retraction of the femoral neck.



## **RETRACTORS, SKIN AND BONE HOOKS**

# BONE HOOKS

## Bone Hook Sharp

- 24.5cm/9¾" length
- Sharp

13-268-24



## Blunt Hook

- 20cm/8" length

13-269-20



## Wroblenski Dislocating Hook

- 25cm/10" length
- For hooking around the neck of the Femur

13-273-25



## McMinn Dislocating Hook

- 25cm/10" length
- Blunt hook with Tufnol handle

13-274-25





# BONE HOOKS



## Frazier

- 13cm/5" length
- Dura Hook

14-108-13 Sharp  
14-109-13 Blunt



## Graefe

- 12.5cm/4¾" length
- Skin Hook

14-110-13 Sharp  
14-111-13 Blunt

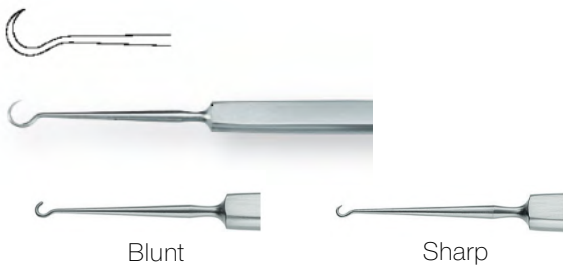

## O'Connor

- 12cm/4¾" length
- 12cm/4¾" length

14-112-12



# BONE HOOKS



## Cushing

- 14cm/5½" length
- Fine Wound Retractor

14-114-14



## Kilner

- 15cm/6" length
- Fine Wound Retractor

14-116-15



## Kilner (Catspaw)

- 15cm/6" length
- Fine Wound Retractor

14-117-15



# BONE HOOKS



## Jaeger

- 13cm/5" length
- Fine Wound Hook

- |           |       |
|-----------|-------|
| 14-120-13 | Small |
| 14-122-13 | Large |



Small



Large

## Cottle

- 15cm/6" length
- Tenaculum Hook

- |           |      |
|-----------|------|
| 14-124-15 | 120° |
| 14-125-15 | 180° |



120° retrograde curved



180° retrograde curved

## Mannerfelt

- 15.5cm/6" length
- Hook Sharp

- |           |
|-----------|
| 14-130-15 |
|-----------|



## Mannerfelt

- 15.5cm/6" length
- Small Curve

### 2 Prongs

- |           |       |
|-----------|-------|
| 14-132-15 | Sharp |
| 14-133-15 | Blunt |

### 3 Prongs

- |           |       |
|-----------|-------|
| 14-136-15 | Sharp |
| 14-137-13 | Blunt |



Blunt



Sharp

## Mannerfelt

- 15.5cm/6" length
- Long Curve

### 2 Prongs

- |           |       |
|-----------|-------|
| 14-140-15 | Sharp |
| 14-141-15 | Blunt |

### 3 Prongs

- |           |       |
|-----------|-------|
| 14-144-15 | Sharp |
| 14-145-13 | Blunt |



Blunt



Sharp

# BONE HOOKS



## Joseph

- 16cm/6¼" length
- Hooklet, Sharp

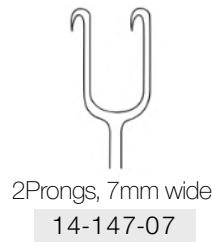
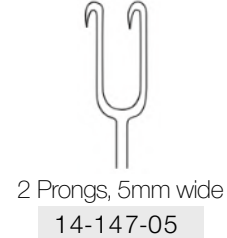
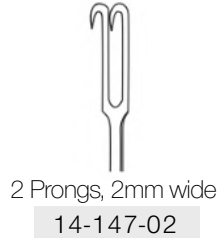
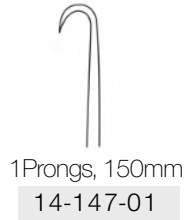

## Freer

- 15cm/6¼" length
- Skin Hook, Double
- 2.5mm wide



- 14-149-15 Sharp
- 14-150-15 Blunt

## Guthrie

- 16cm/6¼" length
- Hook, Sharp



- 14-151-16 Fig.1
- 14-152-16 Fig.2



## Lahey

- 12cm/4¾" length
- Wound Retractor Sharp



- 14-154-12 2 Hooks
- 14-155-12 3 Hooks



# BONE HOOKS



## Cottle

- 14cm/5½" length
- Hooklet



- 14-156-14 2 Sharp Prongs
- 14-157-14 Ball End Prong, Left
- 14-158-14 Ball End Prong, Right

## Cottle Neivert

- 22cm/8¾" length
- Double-Ended Retractor



14-160-22



## Penn-Humby

- 11.5cm/4½" length
- Double Skin Hook, Sharp



14-162-12

## Barsky

- 15cm/6" length
- Fine Wound Retractor, Detachable



- 14-164-15 Single Prong
- 14-155-15 Double Prong

## Gillies

- 18cm/7" length
- Fine Wound Retractor, Sharp



- 14-166-18 Fig.1
- 14-167-18 Fig.2

## RZ

- 17.5cm/6¾" length
- Square Round Hook



- 14-168-17 Blunt
- 14-169-17 Sharp

# BONE HOOKS



## Fomon

- 16cm/6¼" length
- Hooklet



14-171-16

## Fomon

- 13cm/6¼" length
- Hooklet, Insulated



14-172-16

## Mannerfelt (Mod.)

- 15.5cm/6" length
- Forked Hooked, retrograde curved



14-174-15

14-175-15

## Mannerfelt

- 17.5cm/6¾" length
- Square Handle, Fork Retractor



2 Prongs

14-175-15 15mm

14-175-23 23mm

## Rake (Flexible)

- 16.5cm/6½" length

2 Prongs

14-176-16 Sharp

14-177-16 Blunt

3 Prongs

14-178-16 Sharp

14-179-16 Blunt

4 Prongs

14-180-16 Sharp

14-181-16 Blunt



# RETRACTORS



Volkman

• 21.5cm/8½" length



Sharp



14-213-01



14-213-02



14-213-03



14-213-04



14-213-05

Blunt



14-214-01



14-214-02



14-214-03



14-214-04



14-214-05

Semi Sharp



14-215-01



14-215-02



14-215-03



14-215-04



14-215-05

# RETRACTORS



## Kocher

- 22cm/8¾" length
- Semi sharp teeth



Sharp



14-221-01



14-221-02



14-221-03



14-221-04



14-221-05

Blunt



14-222-01



14-222-02



14-222-03



14-222-04



14-222-05

Semi Sharp



14-223-01



14-223-02



14-223-03



14-223-04



14-223-05



# RETRACTORS



## Meyering Retractor

- 

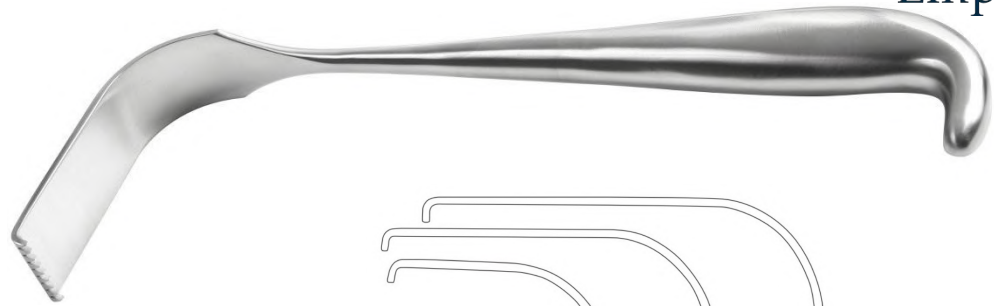

|           | Blade size  | Length     |
|-----------|-------------|------------|
| 14-206-22 | 50mm x 16mm | 23cm/9"    |
| 14-206-23 | 70mm x 25mm | 23cm/9"    |
| 14-206-25 | 90mm x 50mm | 25.5cm/10" |

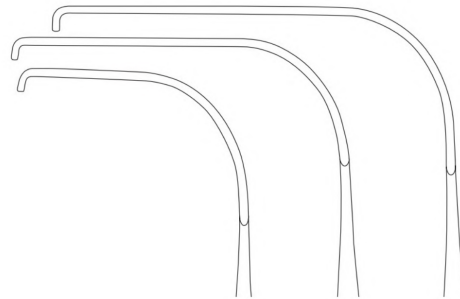

23cm/9" 23cm/9" 25.5cm/10"

## Langenbeck Retractor

- 21.5cm/8½" length
- Ring Handle



|           | Blade size  |             |
|-----------|-------------|-------------|
| 14-210-06 | 22mm x 6mm  | Small       |
| 14-210-13 | 45mm x 13mm | Medium      |
| 14-210-25 | 65mm x 25mm | Large       |
| 14-210-20 | 90mm x 20mm | Extra large |

## Langenbeck Retractor

- 21.5cm/8½" length
- Solid Handle



|           | Blade size  |             |
|-----------|-------------|-------------|
| 14-211-06 | 22mm x 6mm  | Small       |
| 14-211-13 | 45mm x 13mm | Medium      |
| 14-211-25 | 65mm x 25mm | Large       |
| 14-211-20 | 90mm x 20mm | Extra large |

## McCulloch Nerve Root Retractor

- 12.5cm/5" length
- 6mm Tip



# RETRACTORS



## Kocher

- 23cm/6¾" length
- Reusable, 60 x 20mm

15-315-20



- 21.5cm/8½" length
- 25 x 06mm

15-317-01

- 21.5cm/8½" length
- 41 x 11mm

15-317-05

## Koerte

- 21.5cm/8½" length
- Retractor, 8 Prongs



14-207-40

40mm x 30mm

Sharp

14-207-41

40mm x 30mm

Blunt

## Koerte-Wagner

- 28cm/11" length
- Semi Sharp
- 8 Prongs, 25x40mm

14-208-28



## Israel

- 25cm/10" length



4 Prongs, 40x40mm

14-209-01



6 Prongs, 50x60mm

14-209-03



5 Prongs, 45x50mm

14-209-02



6 Prongs, 70x70mm

14-209-04

# HIP RETRACTORS



## Blade with Square Fitting

- Standard depth 50mm  
14-230-50
- Extra depth 75mm  
14-230-75
- Extra, extra depth 100mm  
14-230-10

Frame only  
14-230-01

## Blade with Round Fitting



- Standard depth 40mm  
14-231-40
- Extra depth 75mm  
14-231-75
- Extra, extra depth 100mm  
14-231-10

### 14-230-00 Complete Set - Basic

#### Consisting of:

- 1x Frame
- 1x Weight & chain
- 1x Square fitting blade - 50mm depth
- 1x Round fitting blade - 40mm depth

### 14-230-05 Complete Set - Extended

#### Consisting of:

- 1x Frame
- 1x Weight & chain
- 3x Square fitting blades:
  - 50mm depth
  - 75mm depth
  - 100mm depth
- 3x Round fitting blades:
  - 40mm depth
  - 75mm depth
  - 100mm depth



Weight & chain  
14-230-07



# ACETABULUM RETRACTORS



## Double Bent Hohmann Retractors

- Single Prong
- Blade width 15mm

11.25" length  
Blade and tip length 3.5"

14-266-11 (A)

10.50" length  
Blade and tip length 2.5"

14-267-10 (B)



## Double Bent Hohmann Retractors

- Single & Double Prong, Long
- Blade width 15mm

12.50" length  
Blade and tip length 3"

14-268-12 (A)

12.50" length  
Blade and tip length 3"

14-269-12 (B)

12.50" length  
Blade and tip length 3"

14-270-12 (C)

13.75" length  
Blade and tip length 5"

14-271-13 (D)

12.50" length  
Blade and tip length 3"

14-272-12 (E)



### (C) EXTRA GRIP TIP

Serrated Blade with extra grip, helps to stabilize the retractor around the bone.

## Double Bent Hohmann Retractors

- Single Prong, Extra Long
- Blade width 15mm

18" length  
Blade and tip length 5"

14-273-18 (A)

16.25" length  
Blade and tip length 3"

14-274-16 (B)



# ACETABULUM RETRACTORS



## APC Hip Retractor Series

14" length  
Blade width 22mm  
Single Prong

14-276-14 (A)

14" length  
Blade width 24mm  
Double Prong, Standard

14-278-14 (B)

14" length  
Double Prong, wide

14-280-14 (C)

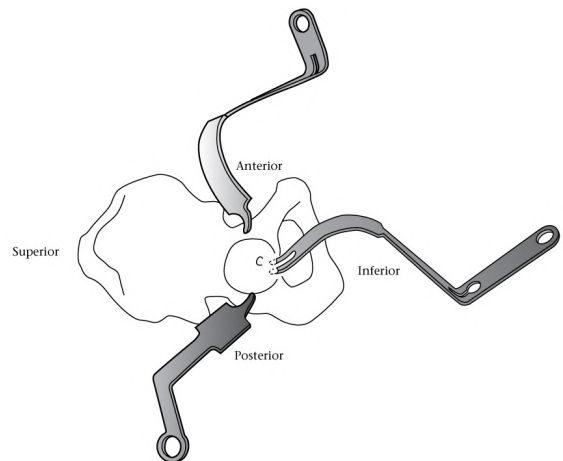
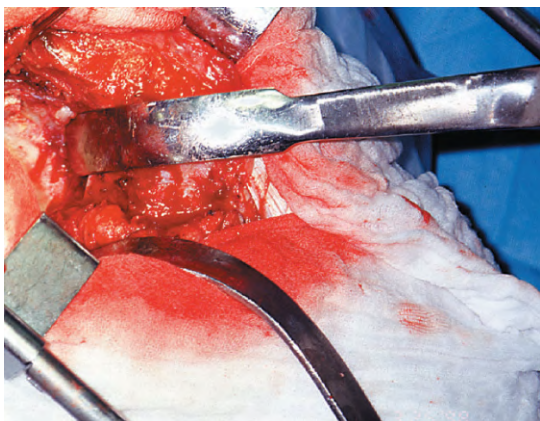
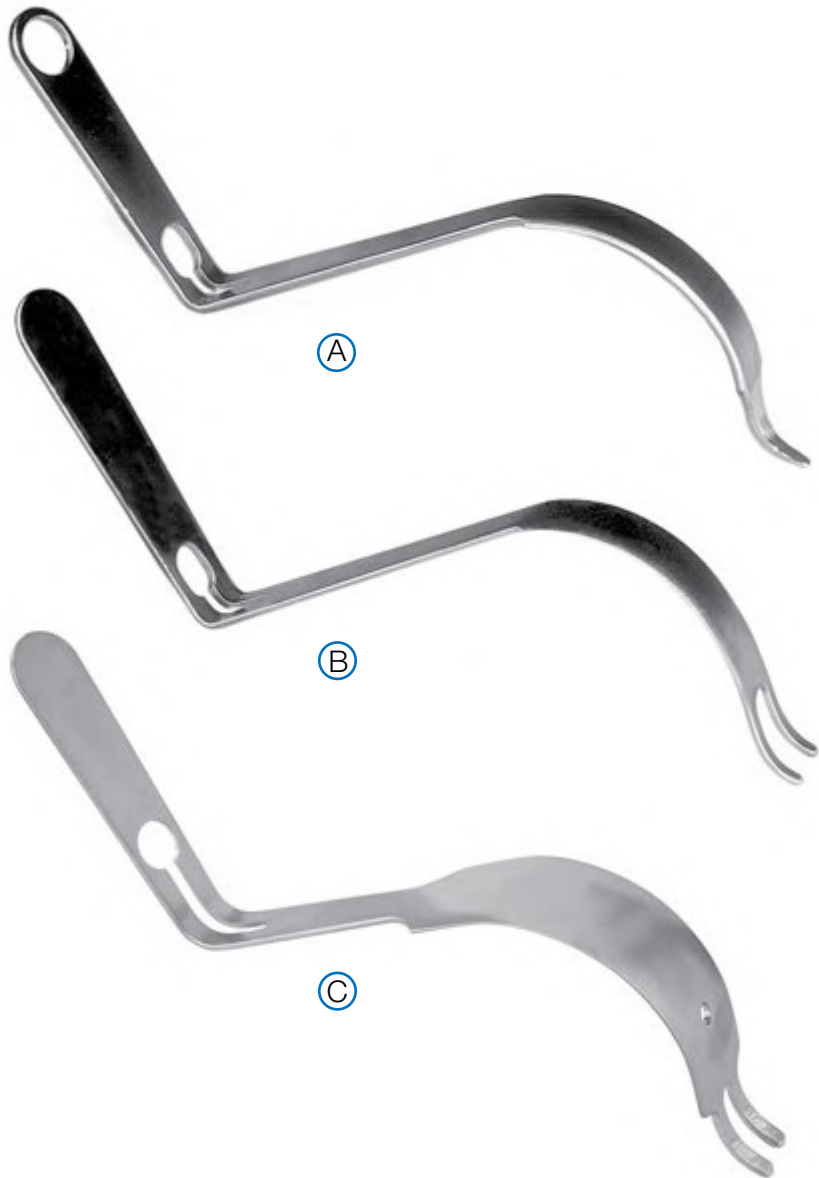

# RETRACTORS



## Goligher Retractor

- Abdominal Self-Retaining Retractor



Frame only  
14-235-01

### 2 Central Blades

- 90mm deep x 90mm wide  
14-235-90 (A)
- 55mm deep x 90mm wide  
14-235-55 (B)

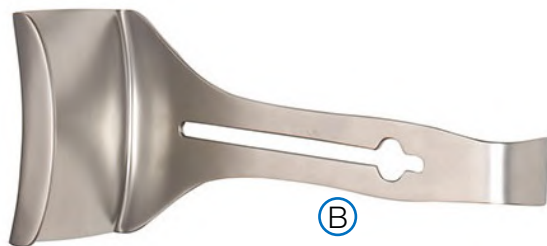

### EM526GN Complete Set - Basic

Consisting of:

- 1x Frame
- 2x Set of Lateral Blades (14-236-90), (14-236-50)
- 2x Central blades (14-235-90), (14-235-55)

### 2 Sets of Lateral Blades

- 90mm deep x 50mm wide  
14-236-90 (C)
- 50mm deep x 30mm wide  
14-236-50 (D)



# RETRACTORS



## West's S/R Retractor

- 14cm/5½" length
- 3x4 **Sharp** prongs

14-236-14

## Weitlaner S/R Retractor

- 14cm/5½" length
- 3x4 **Blunt** prongs

14-237-14

## Weitlaner S/R Retractor

- 14cm/5½" length
- 3x4 **Semi Sharp** prongs

14-238-14



## Travers S/R Retractor

- 20cm/8" length
- 4x5 **Blunt** prongs

14-240-20



## Norfolk and Norwich S/R Retractor

- 22cm/8¾" length
- 4x5 **Blunt** prongs

15-733-22



## Gelpi Laminectomy Retractor

- **Sharp** prongs

|           | Length     | Prong depth |
|-----------|------------|-------------|
| 14-244-18 | 18.5cm/7¼" | 30mm        |
| 14-244-19 | 19.5cm/7¾" | 50mm        |
| EM581GN   | 30cm/11¾"  | 70mm        |
| EM582GN   | 30cm/11¾"  | 100mm       |



# RETRACTORS



## Mollison S/R Retractor

- 15.5cm/6" length
- 4x4 **Sharp** prongs

15-754-15



---

## Mollison S/R Retractor

- 14cm/5½" length, Curved
- 2x2 **Sharp** prongs

15-754-16





# RETRACTORS



## Charnley Vertical Retractor

- 24.5cm/9½" length
- 4x4 Sharp prongs
- Blade depth 22mm

14-248-24



## Cones Self Retaining Retractor

- 3x4 Prongs
- Jointed arms



| Blunt Prongs | Length   | Depth | Sharp Prongs | Length   | Depth |
|--------------|----------|-------|--------------|----------|-------|
| 14-252-13    | 13cm/5"  | 15mm  | 14-253-13    | 13cm/5"  | 15mm  |
| 14-252-16    | 16cm/6¼" | 15mm  | 14-253-16    | 16cm/6¼" | 15mm  |
| 14-252-20    | 20cm/8"  | 20mm  | 14-253-20    | 20cm/8"  | 20mm  |
| 14-252-24    | 24cm/9½" | 25mm  | 14-253-24    | 24cm/9½" | 25mm  |

## Harvey Jackson Self Retaining Retractor

- 30.5cm/12" length
- Blade depth 45mm
- 3x3 Sharp prongs

14-256-30



# RETRACTORS



## Charnley Horizontal Hip Retractor

- 28cm/11" length
- Blade depth 18mm
- Hinged joint
- 7" opening

14-249-28



To retract the detached trochanter headwards, and the femur towards the feet

## Hardinge Horizontal Retractor

- Blade depth 18mm
- Hinged joint

14-250-28

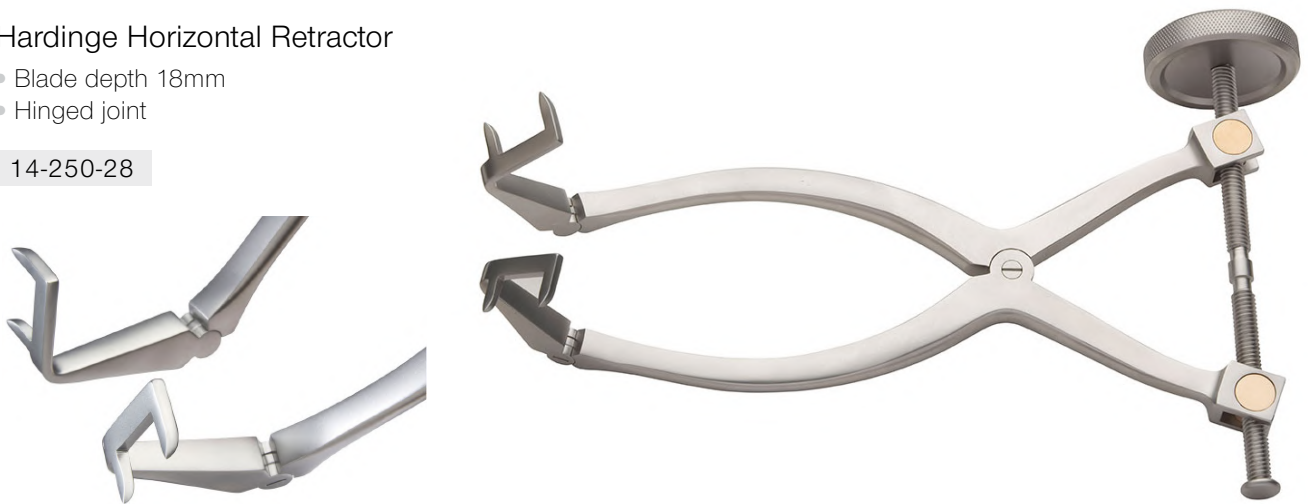

## Charnley Pin Retractor

Complete set with:

- T-handle introducer
- Pair of pins with chains

14-251-00

14-251-01 T-handle only

14-251-02 Pair of pins with chain only

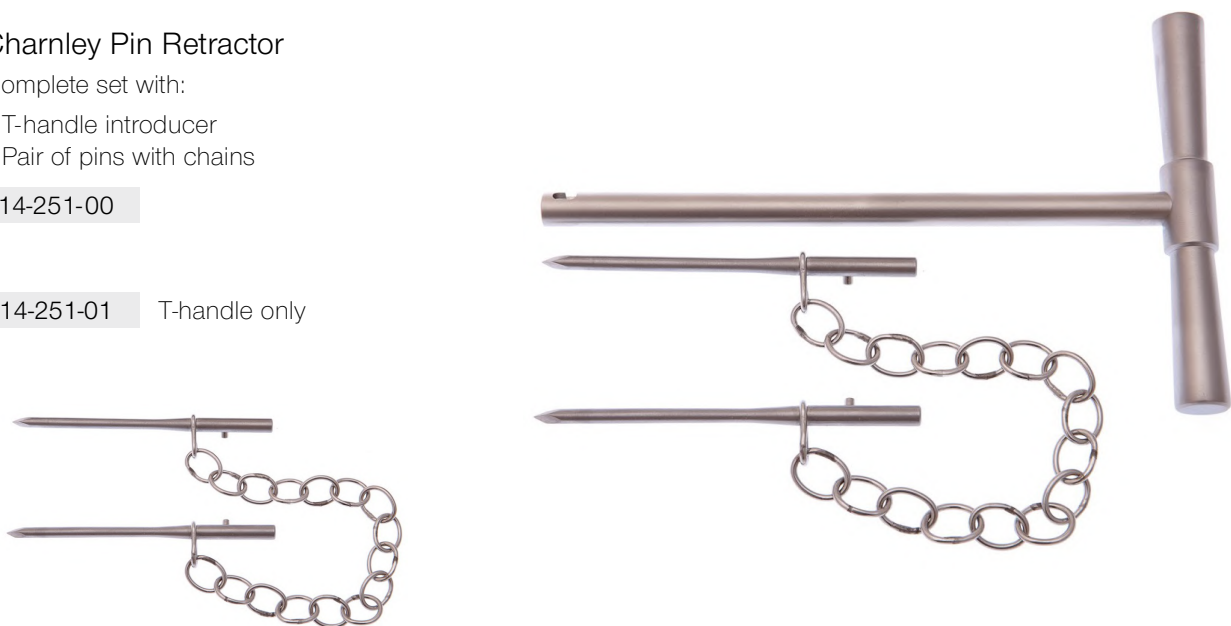

# RETRACTORS



## Viper Hinged Scoliosis Retractor

- 30cm/11¾" length
- Sharp

Depth Prongs

|            |       |
|------------|-------|
| 14-261-38H | 40mm  |
| 14-261-40H | 70mm  |
| 14-261-50H | 100mm |

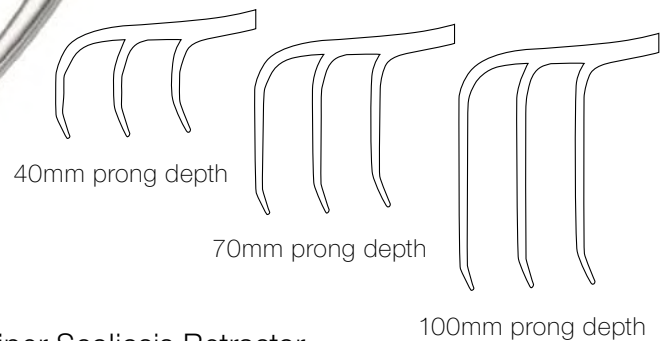

## Viper Scoliosis Retractor

- 30cm/11¾" length
- Sharp prongs

Depth Prongs

|           |       |
|-----------|-------|
| 14-262-38 | 40mm  |
| 14-262-40 | 70mm  |
| 14-262-50 | 100mm |



## BONE HOLDING

# BONE HOLDING FORCEPS



## Langenbeck Bone Holding Forceps

- 20cm/8" length

13-808-20

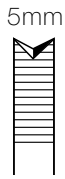

## Frosch Bone Holding Forceps

- 18cm/7" length
- Toothed/serrated jaws

13-806-18



## St. Thomas Bone Holding Forceps

- 18cm/7" length
- Screw joint

13-805-18



## Fergusson Bone Holding Forceps

- 21cm/8¼" length
- Screw joint

13-804-21



## Langenbeck Bone Holding Forceps

- 21cm/8¼" length

13-802-21



# BONE HOLDING FORCEPS



## Trochanter Holding Forceps

- 21cm/9" length

13-803-21



## Hey Groves Bone Holding Forceps

- Screw joints
- Serrated jaws

Length

|           |                                       |        |
|-----------|---------------------------------------|--------|
| 13-834-21 | 21cm/9"                               | Small  |
| 13-834-27 | 27cm/10 <sup>3</sup> / <sub>4</sub> " | Medium |
| 13-834-30 | 30.5cm/12"                            | Large  |



## Verbrugge Bone Holding Forceps

- 17.5cm/9" length

13-837-17

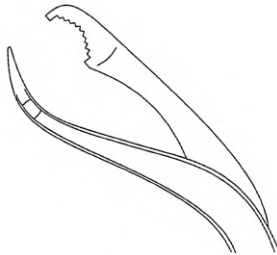

## Verbrugge Bone Holding Forceps

Length

|           |                                       |       |
|-----------|---------------------------------------|-------|
| 13-835-01 | 25cm/10"                              | Small |
| 13-835-02 | 26cm/10 <sup>1</sup> / <sub>4</sub> " | Me    |
| 13-835-03 | 27cm/10 <sup>3</sup> / <sub>4</sub> " | Large |



# BONE HOLDING FORCEPS



## Verbrugge

- Self-Centering Forceps with thread fixation

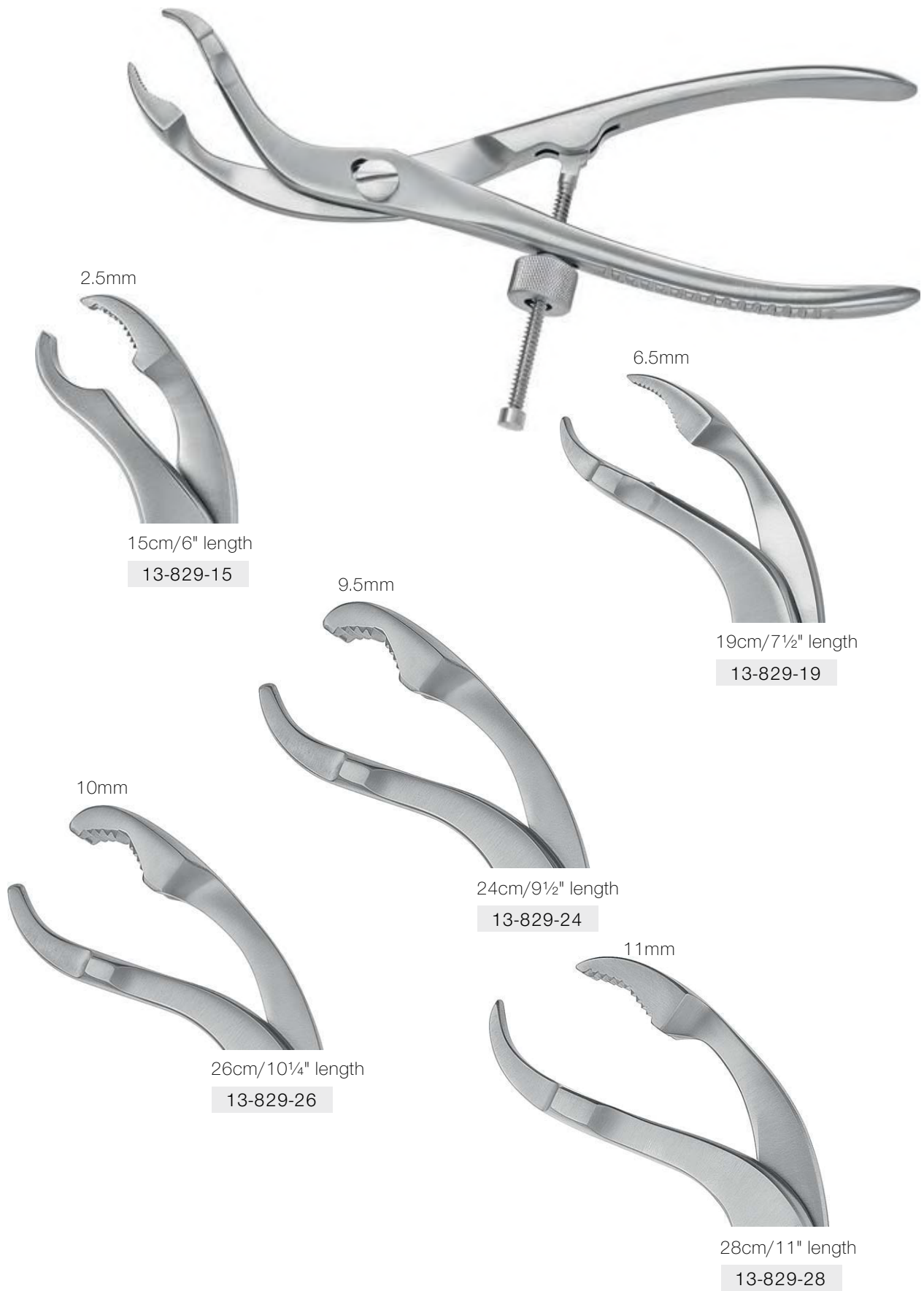

# BONE HOLDING FORCEPS



## Semb

- 19cm/7½" length
- Lateral Curved, with ratchet

13-813-19



## Semb

- 19cm/7½" length
- Angled to side

13-815-19



## Lane

- With Ratchet

Length

13-832-33

33cm/13"

13-832-45

45cm/17¾"

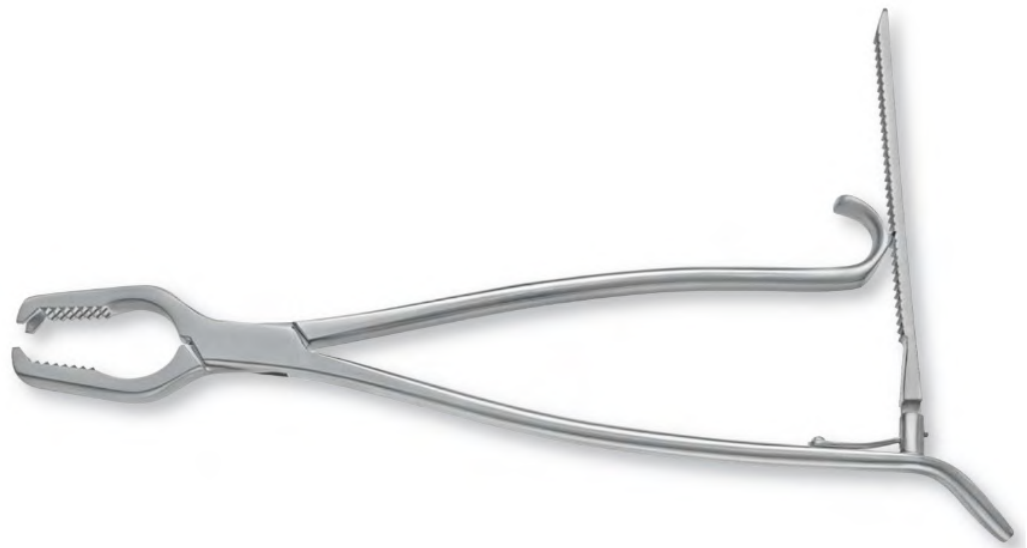

## Lane

- Without Ratchet

Length

13-830-33

33cm/13"

13-830-45

45cm/17¾"





# BONE HOLDING FORCEPS



## Kern

- Without ratchet

|           | Length   |
|-----------|----------|
| 13-810-15 | 15cm/6"  |
| 13-810-17 | 17cm/6¾" |
| 13-810-21 | 21cm/8¼" |

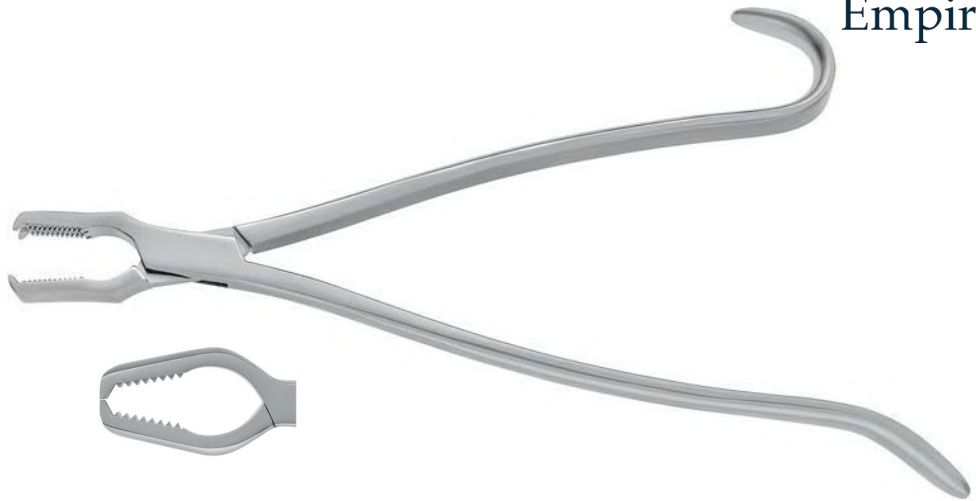

## Kern

- With Ratchet

|           | Length   |
|-----------|----------|
| 13-812-15 | 15cm/6"  |
| 13-812-17 | 17cm/6¾" |
| 13-812-21 | 21cm/8¼" |



## Lambotte

- With movable jaw

|           | Length    |
|-----------|-----------|
| 13-817-21 | 21cm/8¼"  |
| 13-817-26 | 26cm/10¼" |
| 13-817-33 | 33cm/13"  |



## Lambotte

- With movable jaw

|           | Length    |
|-----------|-----------|
| 13-819-19 | 19cm/7½"  |
| 13-819-23 | 23cm/6¾"  |
| 13-819-26 | 26cm/10¼" |



# BONE HOLDING FORCEPS



## Farabeuf-Lambotte

- 26cm/10¼" length

13-822-26



## Farabeuf-Lambotte

- 26cm/10¼" length

13-823-26



## Ferabeuf

13-820-23

Length

23cm/6¾"

13-820-26

26cm/10¼"



## Lambotte

- With movable jaw

Length

13-824-22

22cm/8¾"

13-824-27

27cm/10¾"

13-824-30

30cm/12"



# BONE HOLDING FORCEPS



## Ulrich

- Straight

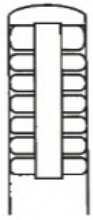

Fig.1

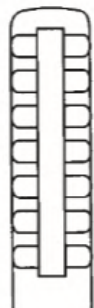

Fig.2



Fig.3

|           | Length   |       |
|-----------|----------|-------|
| 13-826-23 | 23cm/6¾" | Fig.1 |
| 13-826-25 | 25cm/9¾" | Fig.2 |
| 13-826-28 | 28cm/11" | Fig.3 |

## Ulrich

- Laterally Angled

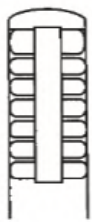

Fig.1

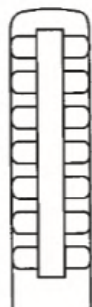

Fig.2



Fig.3

|           | Length   |       |
|-----------|----------|-------|
| 13-827-23 | 23cm/6¾" | Fig.1 |
| 13-827-25 | 25cm/9¾" | Fig.2 |
| 13-827-28 | 28cm/11" | Fig.3 |

# BONE HOLDING FORCEPS



## Sequestrum

- 20cm/8" length

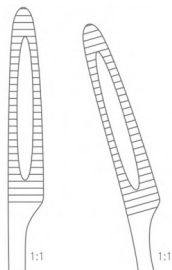

13-776-20 13-777-20

## Patella

- 18cm/7" length

13-774-18



## Cartilage

- 14cm/7" length
- Curved

13-784-14

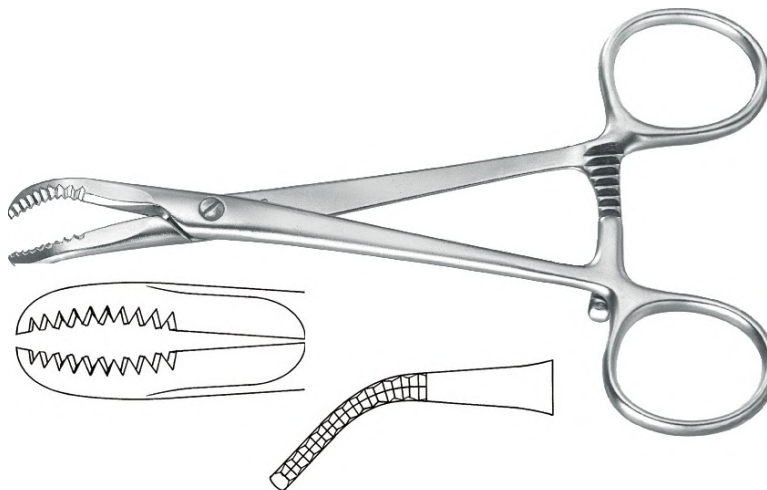

## Van Buren

- 23cm/9" length

13-778-23



# BONE HOLDING FORCEPS



## Reposition Forceps

- 9.5cm/3¾" length

13-800-09



## Reposition Forceps

- 13.5cm/5¼" length
- For maxillary reposition

13-801-13



## Steinhauser Reposition Forceps

- 13.5cm/5¼" length

13-793-13



## Bone Holding Forceps

- 12cm/4¾" length

13-796-12

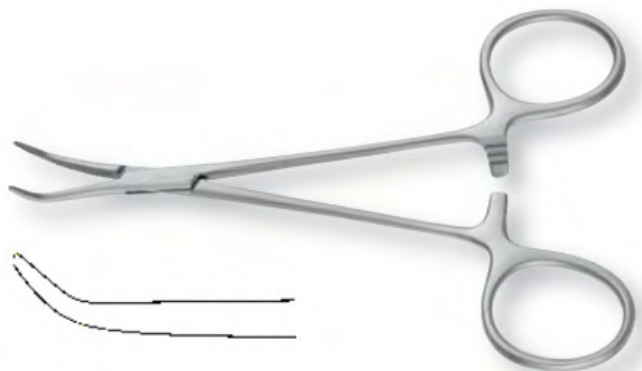

# BONE HOLDING FORCEPS



## Reposition Forceps

- 12cm/4¾" length
- Bone Fragment Clamp

13-791-12



## Bone Holding Forceps

- 14.5cm/5¾" length
- With guide for K-wire

|           |       |
|-----------|-------|
| 13-797-11 | 1.1mm |
| 13-797-13 | 1.3mm |
| 13-797-16 | 1.6mm |



## Stagbeetle Reposition Forceps

- 12 cm/4¾" length
- Curved, Fine Tips

13-798-12

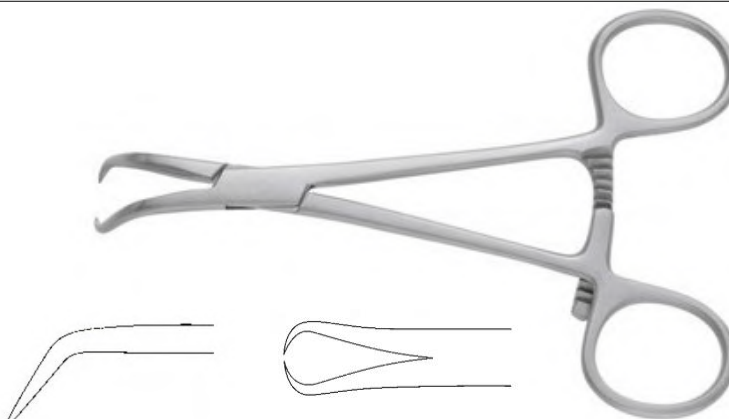

## Reil Reduction Forceps

- 20cm/8" length

13-770-19

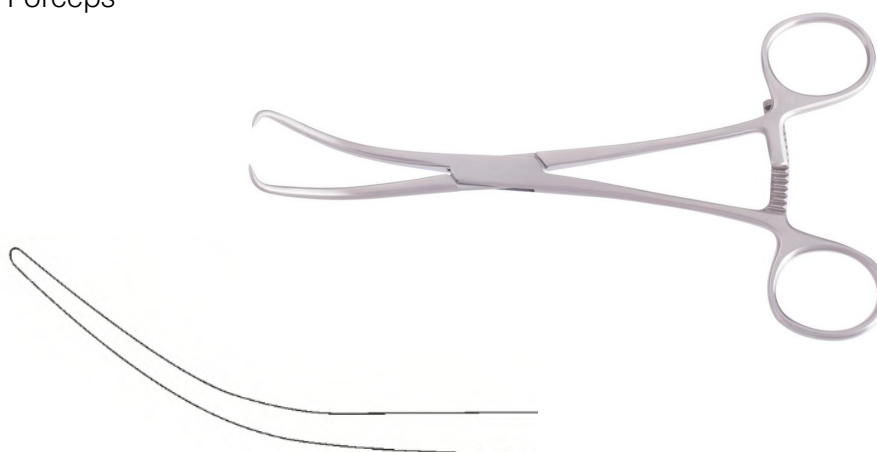

# BONE HOLDING FORCEPS



## Reposition Forceps

- 20cm/8" length

13-770-20



## Meyer

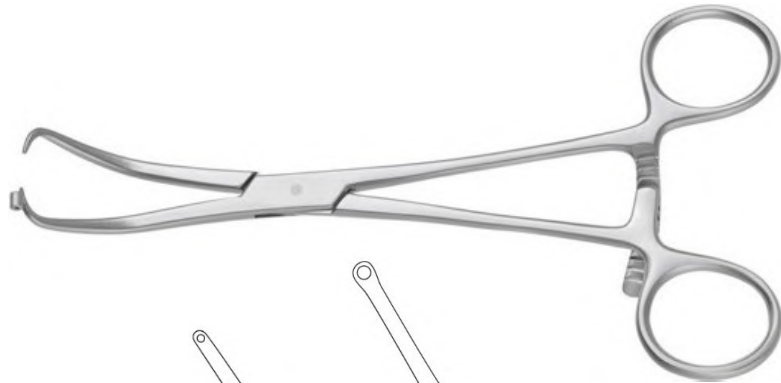

For K-wire

Length

13-772-17

1.0mm

17cm//6¾"

13-772-20

2.0mm

20.5cm//8"

## Bankart

- 17cm/6¾" length
- Perforating Forceps



Lightly Curved

13-773-17



Strongly Curved

13-773-18



## Lewin

- 17.5cm/6¾" length
- Serrated, Slightly Curved

13-792-17



# PELVIC REDUCTION INSTRUMENTS



## Pelvic Reduction Forceps

- 19cm/7½" length
- Angled, small
- Pointed ball tips
- Speed lock

13-839-01



## Pelvic Reduction Forceps

- 24.5cm/9½" length
- Angled, large
- Pointed ball tips
- Speed lock

13-839-02



## Pelvic Reduction Forceps

- 25cm/10" length
- Straight, large
- Pointed ball tips
- Speed lock

13-839-03





# PELVIC REDUCTION INSTRUMENTS



## Pelvic Reduction Forceps

- 40.5cm/16½" length
- Pointed ball tips
- Speed lock

13-839-06



## Pelvic Reduction Forceps

- 34.5cm/14" length
- With quick lock

13-839-07



## Ball Spike

- 30.5cm/9½" length

13-839-08

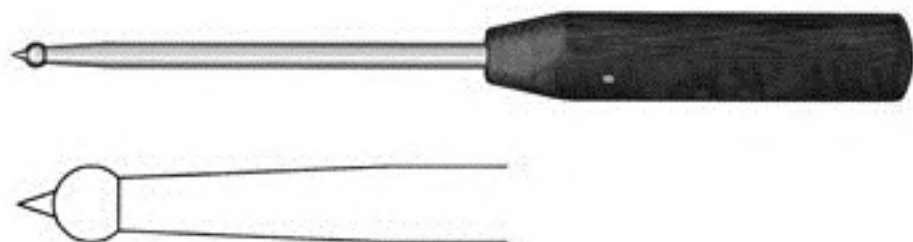

## Pelvic Reduction Forceps

- 41cm/16" length
- Pointed ball tips
- Speed lock

13-839-05



---

## Pelvic Reduction Forceps

- 40cm/16" length
- 3 pointed ball tips
- Speed lock

13-839-04



# BONE HOLDING CLAMPS



## Lowmann

- Bone Holding Clamp
- 1x1 Teeth



|           | Length     |
|-----------|------------|
| 14-861-13 | 13cm/5"    |
| 14-861-18 | 18.5cm/7¼" |
| 14-861-20 | 20cm/8"    |

## Lowmann

- Bone Holding Clamp
- 1x2 Teeth



|           | Length   |
|-----------|----------|
| 13-177-12 | 12cm/4¾" |
| 13-177-18 | 18cm/7"  |
| 13-177-20 | 20cm/8"  |
| 13-177-22 | 22cm/8¾" |

## Lambart Lowmann

- Bone Holding Clamp
- 2x2 Teeth



|           | Length   |
|-----------|----------|
| 13-179-18 | 18cm/7"  |
| 13-179-20 | 20cm/8"  |
| 13-179-22 | 22cm/8¾" |

# BONE HOLDING CLAMPS



## Lowmann-Hoglund

- Bone Holding Clamp, Rotatable
- 2x2 Teeth



Length

|           |                                      |
|-----------|--------------------------------------|
| 13-178-18 | 18cm/7"                              |
| 13-178-20 | 20cm/8"                              |
| 13-178-22 | 22cm/8 <sup>3</sup> / <sub>4</sub> " |

---

## Gerster

- Traction Bar
- 9cm/3<sup>1</sup>/<sub>2</sub>" length

13-178-09

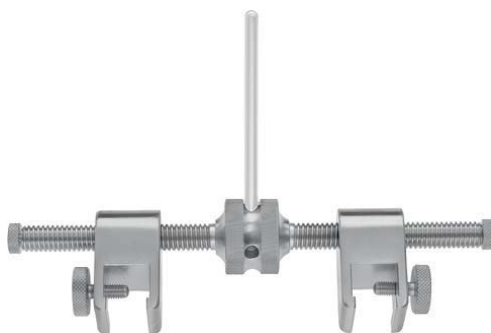



## CARTILAGE AND TENDON

# TENDON



## Smillie

- 14cm/5½" length

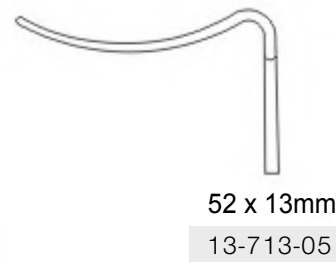
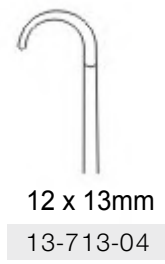
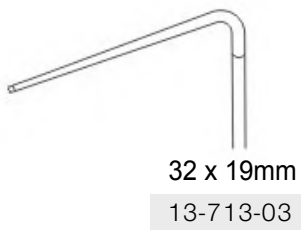
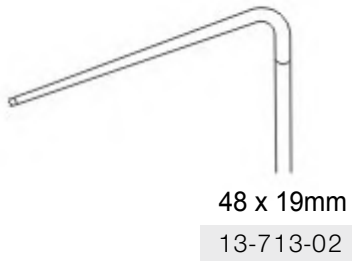
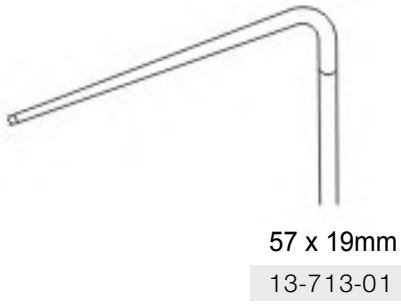

# TENDON GRASPING FORCEPS

## Larsen

- Grasping Forceps
- 10cm/4" length



## Herz

- Grasping Forceps
- 15.5cm/6" length

|           | Serration |
|-----------|-----------|
| 13-764-01 | Fine      |
| 13-764-02 | Coarse    |

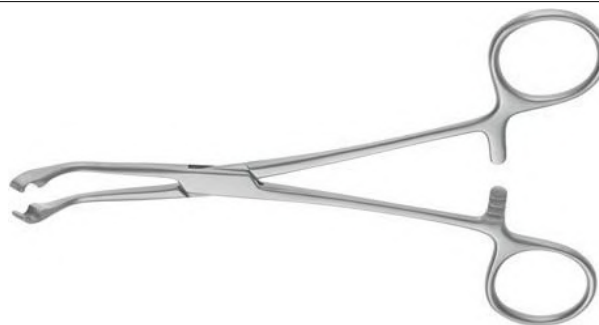

## Halsted-Mosquito

- Grasping Forceps
- 15cm/6" length

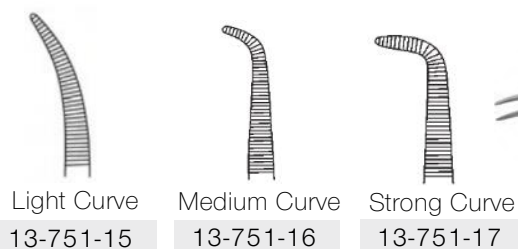

## Englert

- 4x5 Atraumatic Teeth
- 14.5cm/5¾" length

13-761-15



## Ombredanne(Iselin)

- 4x5 Teeth
- 16cm/6¼" length

14-870-16

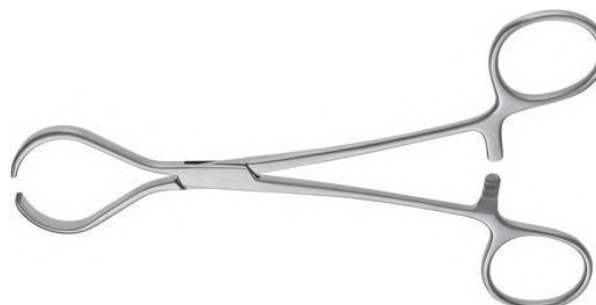

## Tendon Interlacing

- 15cm/6" length

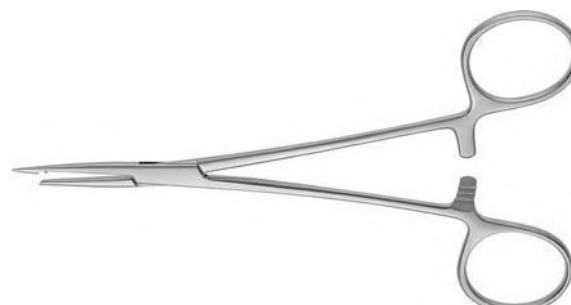
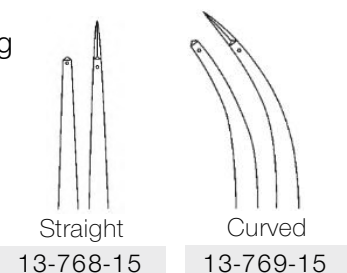

# TENDON



## Tendon Seizing Forceps

- With 3 Pins
- 13cm/5" length

13-766-13



## Steinmann

- Seizing Forceps
- 16cm/6¼" length

13-758-16

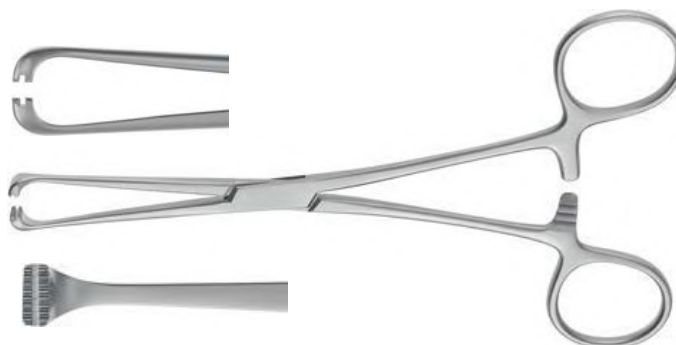

## Carroll

- Tendon Forceps, Curved
- 11cm/4½" length

13-765-11

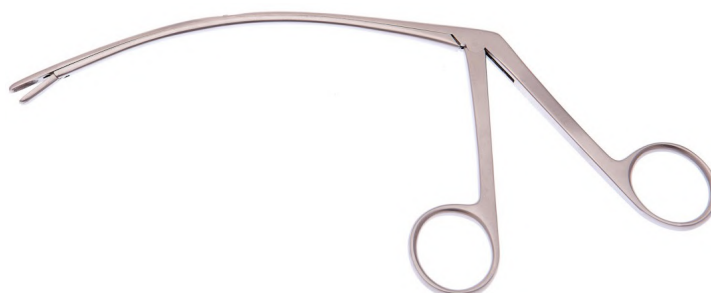

## Hoen

- Tendon Grasping Forceps
- 1x2 Teeth
- 12cm/4¾" length

13-765-11



## Anderson

Brand Tendon Retriever, Light Model  
20.5cm/8" length

13-759-20





# TENDON

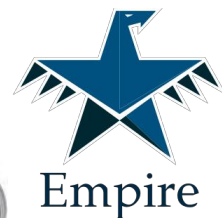

## Brand

- Tendon Seizing Forceps

Length

|           |          |
|-----------|----------|
| 13-760-15 | 15cm/6"  |
| 13-760-19 | 19cm/7½" |
| 13-760-24 | 24cm/9½" |

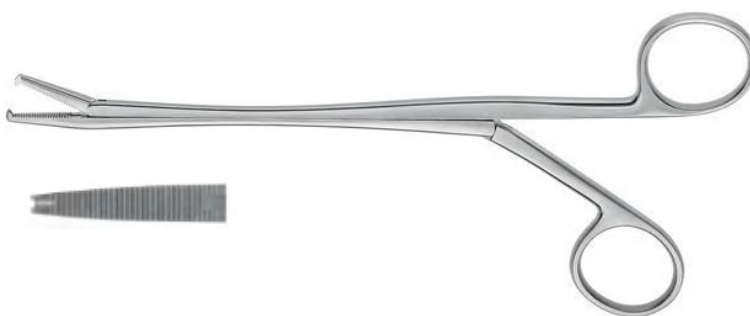

## Brand

- Tendon Seizing Forceps, Curved
- 25cm/10" length

13-761-25



- Tendon Tunnelling Forceps
- 20.5cm/8" length

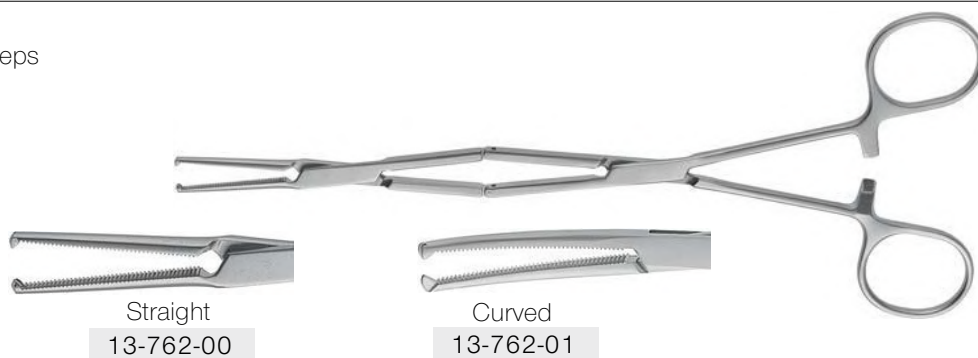

Straight  
13-762-00

Curved  
13-762-01

## Kleinert-Kutz

- Tendon Seizing Forceps, 1x2 Teeth
- Flexible, 1x8mm serrated jaws
- 20cm/8" length

13-767-20



## Bunnell

- Probe, Malleable
- 23cm/9" length

13-754-23



## Dietrich

- Tendon Fixation Needle, 1.7mm
- 45mm/1¾" length

13-755-45



# TENDON



## Bunnell

- Tendon Stripper
- 15cm/6" length

|           |       |       |   |
|-----------|-------|-------|---|
| 13-744-01 | 2.5mm | Fig.1 |  |
| 13-744-02 | 3.0mm | Fig.2 |  |
| 13-744-03 | 4.0mm | Fig.3 |  |
| 13-744-04 | 5.0mm | Fig.4 |  |
| 13-744-05 | 6.5mm | Fig.5 |  |



- Tendon Tunnel Instrument
- With obturating screw
- 33.5cm/13¼" length



13-748-00

Screw Only

13-748-01

- Tendon Stripper
- 28cm/11" length

13-752-28



## Fischer

- Tendon Stripper, Blunt
- Ferrozell Handle
- 31cm/12½" length

13-750-31



- Tendon Stripper
- 23cm/9" length



|   |   |   |
|---|---|---|
|  |  |  |
| 4mm   | 4.5mm   | 5.5mm   |
| 13-746-40   | 13-746-45   | 13-746-55   |

# TENDON



## Bunnell

- Tendon Stripper



- 3mm inner

|           | with slot | Length     |
|-----------|-----------|------------|
| 14-870-28 | 14-871-28 | 28.5cm/11" |
| 14-870-35 | 14-871-35 | 35cm/13¾"  |
| 14-870-60 | 14-871-60 | 60cm/24"   |

- 4mm inner

|           | with slot | Length     |
|-----------|-----------|------------|
| 14-874-28 | 14-875-28 | 28.5cm/11" |
| 14-874-35 | 14-875-35 | 35cm/13¾"  |
| 14-874-60 | 14-875-60 | 60cm/24"   |

- 5mm inner

|           | with slot | Length     |
|-----------|-----------|------------|
| 14-878-28 | 14-879-28 | 28.5cm/11" |
| 14-878-35 | 14-879-35 | 35cm/13¾"  |
| 14-878-60 | 14-879-60 | 60cm/24"   |

- 6mm inner

|           | with slot | Length     |
|-----------|-----------|------------|
| 14-880-28 | 14-881-28 | 28.5cm/11" |
| 14-880-35 | 14-881-35 | 35cm/13¾"  |
| 14-880-60 | 14-881-60 | 60cm/24"   |

## Paul

- Tendon Retractor, Blunt
- 3 Prongs
- 12.5cm/4¾" length



14-886-12

## Klapp

- Tendon Retractor, Blunt
- 3 Prongs
- 17.5cm/7" length



2 Prongs

14-888-02



3 Prongs

14-888-03



4 Prongs

14-888-04

## Strandell-Stille

- Tendon Retractor
- 15x6mm
- 19cm/7½" length



Toothed

14-890-19



Blunt

14-891-19

# TENDON & CARTILAGE



## Stevens

- Tenotomy Scissors

- **Sharp**

| Straight  | Curved    | Length     |
|-----------|-----------|------------|
| 14-900-10 | 14-901-10 | 10.5cm/4¼" |
| 14-901-11 | 14-901-11 | 11.5cm/4½" |

- **Blunt**

| Straight  | Curved    | Length     |
|-----------|-----------|------------|
| 14-903-10 | 14-904-10 | 10.5cm/4¼" |
| 14-904-11 | 14-904-11 | 11.5cm/4½" |



---

## Martin

- Cartilage Scissors
- Curved
- 20cm/8" length

14-906-20



---

## Martin

- Cartilage Scissors
- SuperCut
- 20cm/8" length

14-907-20



---

## Resano

- Capsule Scissors, Angled
- Sharp/Blunt
- 25cm/9½" length

14-908-25



---

## Martin

- Cartilage Holding Forceps
- 19cm/7½" length

13-788-19



# TENDON & CARTILAGE



Empire

## Bircher-Ganske

- Cartilage Holding Forceps
- 20cm/8" length



Straight

13-780-20

Curved upwards

13-781-20



## Bircher-Ganske

- Cartilage Holding Forceps
- 20cm/8" length

13-783-20



## Dingmann

- Cartilage Holding Forceps
- 19cm/7½" length

13-785-19

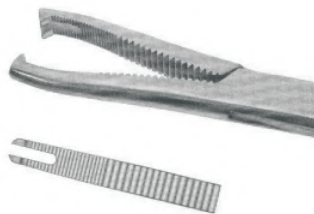

## Dingmann Mod.

- 19cm/7½" length

13-787-19



## Walton

- Cartilage Forceps
- Slightly curved with pins
- 18.5cm/7½" length

13-789-18



## Downing

- Cartilage Knife
- 25.5cm/10" length

13-790-25



# MENISCUS



- Manisotome
- Double Edge
- 18cm/7" length

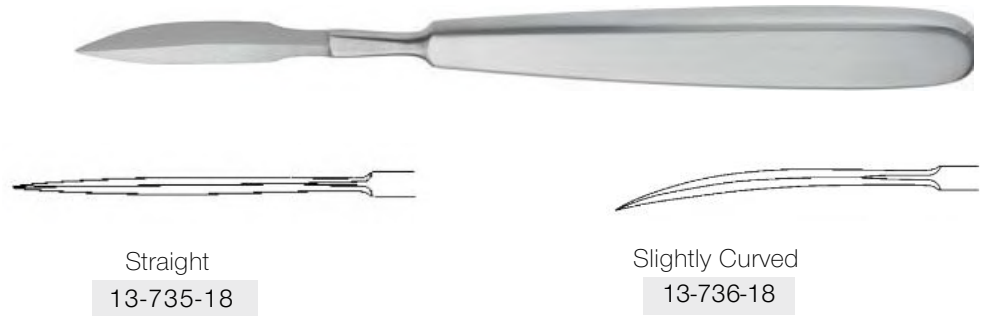

## Neff

- Manisotome
- 22cm/8¾" length

14-906-20



## Bircher

- Manisotome
- 19cm/7½" length

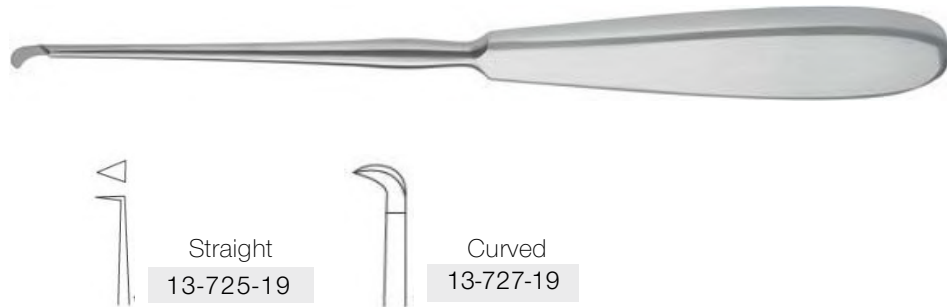

## Salenius

- Manisotome
- 22cm/8¾" length

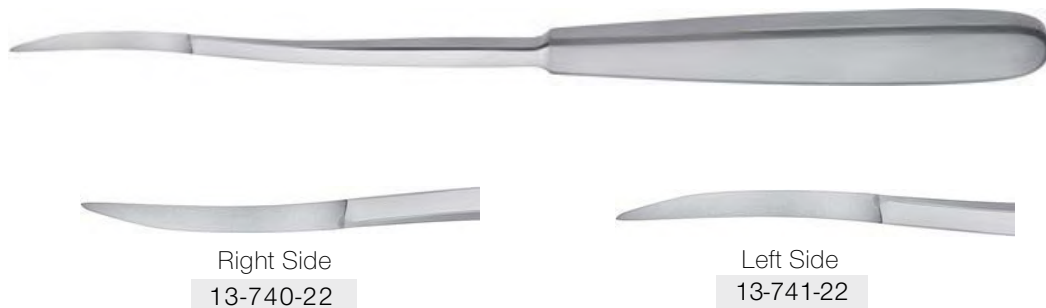

# MENISCUS



## Smille

- Maniscotome, Straight
- 17cm/6¾" length

13-730-17



## Smille

- Maniscotome, with guards
- 17cm/6¾" length



Right  
13-731-17

Left  
13-733-17

## Lowe-Breck

- Maniscotome
- 25cm/10" length

13-734-25



## Preston

- Maniscus Ligament Flavum Forceps
- Serrated Jaws, 1x2 Teeth
- 19cm/7½" length

13-728-19

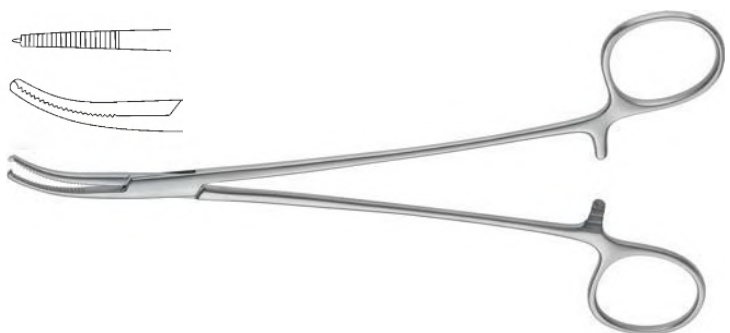

## Bircher

- Maniscus Grasping Forceps
- 20cm/7¾" length

13-729-20

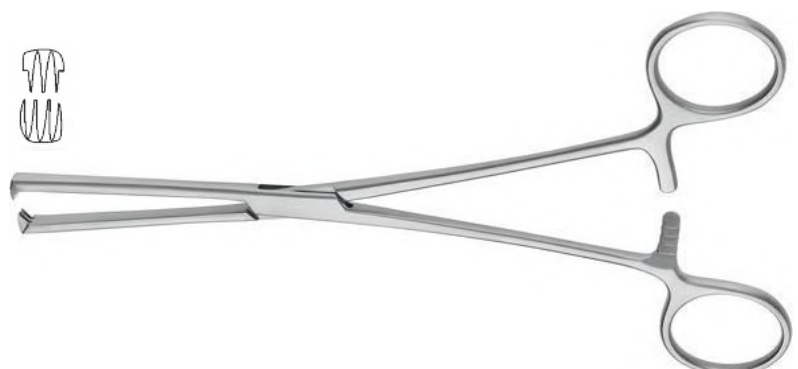



## BONE CURETTES



# BONE CURETTES



## Williger Curette

- 13.5cm/5½" length
- Double curette



○ ○  
**Fig. 00 - 0**  
 2.5/3.0mm  
 13-550-00

○ ○  
**Fig. 0 - 1**  
 3.0/3.5mm  
 13-550-01

○ ○  
**Fig. 1 - 2**  
 3.5/4.2mm  
 13-550-12

## Martini Curette

- 13.5cm/5½" length
- Double curette



○ ○  
**Fig. 00 - 0**  
 2.6/3.1mm  
 13-552-00

○ ○  
**Fig. 0 - 1**  
 3.1/4.2mm  
 13-552-01

○ ○  
**Fig. 1 - 2**  
 4.2/4.8mm  
 13-552-12

## Jansen Curette

- 16cm/6¼" length
- Double curette



○ ○  
**3.0/4.0mm**  
 13-556-16

## Jansen Curette

- 21cm/8¼" length
- Double curette



○ ○  
**6.0/7.0mm**  
 13-560-21

## Jansen Curette

- 15cm/6" length
- Double curette



○ ○  
**3.0/4.0mm**  
 13-557-15

# BONE CURETTES



## Volkman Curette

- 22cm/8¾" length
- Double ended



|           | Size   |             |
|-----------|--------|-------------|
| 13-561-01 | Small  | 2.5x4/5x8mm |
| 13-561-02 | Medium | 4x6/6x10mm  |
| 13-561-03 | Large  | 5x8/7x14mm  |

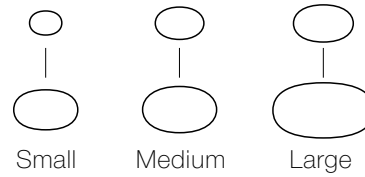

## Volkman Curette

- Double curette

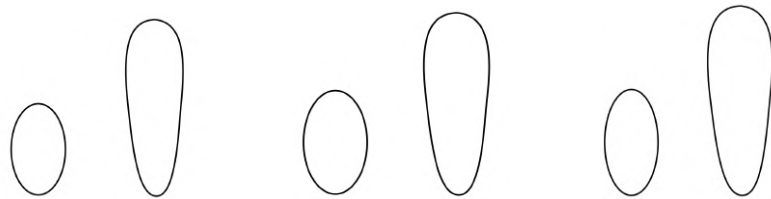

13cm/5"

13-564-13

14cm/5½"

13-564-14

17cm/6¾"

13-564-17

## Volkman Curette

- Double curette

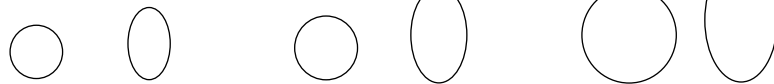

13cm/5"

13-568-13

16cm/6¼"

13-568-16

20cm/8"

13-568-20

## Jacobson Curette

- 14cm/5½" length
- Double curette



13-558-14

## Hemingway Curette

- 16.5cm/6½" length
- Double curette



Fig.1

13-573-01



Fig.2

13-573-02



Fig.3

13-573-03

# BONE CURETTES



## House

- 15.5cm/6" length
- Straight
- 1.4x1.8mm / 2x2.5mm

13-570-15



## House

- 15.5cm/6" length
- Angled, 45°
- 1.4x1.8mm / 2x2.5mm

13-571-15



## Lucas

- 16.5cm/6½" length

13-571-15



Fig.1

13-574-01



Fig.2

13-574-02



Fig.3

13-574-03

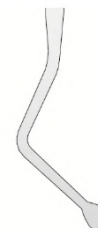
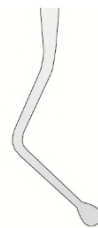

## Barth Curette

- 18cm/7" length
- Double curette

13-569-18



# BONE CURETTES



## Meyerhoefer

- Chalazion Curette
- 13cm/5¼" length



|  |   |  |
|--|---|--|
| ○<br><b>Fig. 000</b> /0.5mm<br>13-575-30 | ○<br><b>Fig. 00</b> /1.0mm<br>13-575-20 | ○<br><b>Fig. 0</b> /1.5mm<br>13-575-10 |
| ○<br><b>Fig. 1</b> /1.8mm<br>13-575-01   | ○<br><b>Fig. 2</b> /2.0mm<br>13-575-02  | ○<br><b>Fig. 3</b> /2.5mm<br>13-575-03 |
| ○<br><b>Fig. 4</b> /3.5mm<br>13-575-04   | ○<br><b>Fig. 5</b> /4.0mm<br>13-575-05  | ○<br><b>Fig. 6</b> /4.5mm<br>13-575-06 |

## Meyerhoefer

- Curette
- 14cm/5½" length



|  |  |  |
|--|--|--|
| ○<br><b>Fig.0</b> /2.0mm<br>13-576-10  | ○<br><b>Fig. 1</b> /2.5mm<br>13-576-01 | ○<br><b>Fig. 2</b> /3.0mm<br>13-576-02 |
| ○<br><b>Fig. 3</b> /3.5mm<br>13-576-03 | ○<br><b>Fig. 4</b> /5.0mm<br>13-576-04 |  |

## Mannrefelt

- Curette
- 15cm/6" length



|                      |                      |                      |
|----------------------|----------------------|----------------------|
| <br>4mm<br>13-577-40 | <br>7mm<br>13-577-70 | <br>9mm<br>13-577-90 |
|----------------------|----------------------|----------------------|

## Williger Curette

- 16cm/6¼" length
- Double Curette



|                                      |                                     |                                     |
|--------------------------------------|-------------------------------------|-------------------------------------|
| ○<br>○<br><b>Fig.00</b><br>13-572-01 | ○<br>○<br><b>Fig.0</b><br>13-572-02 | ○<br>○<br><b>Fig.1</b><br>13-572-03 |
|--------------------------------------|-------------------------------------|-------------------------------------|

# BONE CURETTES



## Luxation Lever

- 31cm/12¼" length
- Tufnol Handle
- 25mm wide

14-430-25



## Bone Curette

- Tufnol handle



Large cup 27mm Ø

14-432-32

32cm/12¾" length



Medium cup 13mm Ø

14-432-27

27cm/10¾" length



Small cup 9mm Ø

14-432-24

24cm/9½" length

## Toothed Bone Curette

- 27cm/10¾" length
- Sharp spoon with teeth
- Tufnol handle



Small cup 9mm Ø

14-435-09

Medium cup 15mm Ø

14-435-15

## Toothed Bone Curette

- 27cm/10¾" length
- Sharp spoon with teeth
- Double Angled, 9mm
- Tufnol handle

14-438-27



# BONE CURETTES



## Kraemer Curette

- 25cm/10" length
- Ring Curette
- Sharpened, Double Sided



|           | Size |
|-----------|------|
| 14-440-04 | 4mm  |
| 14-440-05 | 5mm  |
| 14-440-06 | 6mm  |

## Cone

- 27cm/9¾" length
- Ring Curette



| Straight  | Angled    | Size  |       |
|-----------|-----------|-------|-------|
| 14-442-03 | 14-443-03 | 3.0mm | Fig.3 |
| 14-442-02 | 14-443-02 | 6.0mm | Fig.2 |
| 14-442-01 | 14-443-01 | 8.0mm | Fig.1 |



Straight



Angled

## Caspar

- 22cm/8¾" length
- Bone Scoop, Curved, Toothed
- Tufnol handle



|           |     |
|-----------|-----|
| 14-446-04 | 4mm |
| 14-446-05 | 5mm |
| 14-446-06 | 6mm |

## Charnley Bone Curette

- 37cm/15" length
- T-handle



Small cup 8x12mm

14-448-12



Medium cup 11.5x21.5mm

14-448-21



Large cup 14x24mm

14-448-24

## Charnley Ring Curette

- 37cm/15" length
- Serrated cutting edge
- Double sided
- T-handle



Small 10mm

14-450-10



Medium 16mm

14-450-16



Large 25mm

14-450-25

# BONE CURETTES













## Volkman Curette

- 17cm/6¾" length
- Handle from artificial wood





## Volkman Curette

- 28cm/11" length
- Handle from Artificial wood



|  |  |
|--|--|
| <br><b>Fig. 0000/2.5mm</b><br>13-490-40 | <br><b>Fig. 2/8.5mm</b><br>13-490-02  |
| <br><b>Fig. 000/3.6mm</b><br>13-490-30  | <br><b>Fig. 3/10mm</b><br>13-490-03   |
| <br><b>Fig. 00/4.4mm</b><br>13-490-20   | <br><b>Fig. 4/11.5mm</b><br>13-490-04 |
| <br><b>Fig. 0/5.2mm</b><br>13-490-10    | <br><b>Fig. 5/13mm</b><br>13-490-05   |
| <br><b>Fig. 1/6.8mm</b><br>13-490-01    | <br><b>Fig. 6/14.5mm</b><br>13-490-06 |



|  |
|--|
| <br><b>Fig. 0/5.2mm</b><br>13-492-10  |
| <br><b>Fig. 1/6.8mm</b><br>13-492-01  |
| <br><b>Fig. 2/8.5mm</b><br>13-492-02  |
| <br><b>Fig. 3/10mm</b><br>13-492-03   |
| <br><b>Fig. 4/11.5mm</b><br>13-492-04 |

# BONE CURETTES



## Caspar Curette

- 22cm/8¾" length
- Handle from artificial wood
- Straight

## Caspar Curette

- 22cm/8¾" length
- Handle from Artificial wood
- Angled



○  
Fig. 000/3.6mm  
14-456-30

○  
Fig. 00/4.4mm  
14-456-20

○  
Fig. 0/5.2mm  
14-456-10



○  
Fig. 000/3.6mm  
14-457-30

○  
Fig. 00/4.4mm  
14-457-20

○  
Fig. 0/5.2mm  
14-457-10



# BONE CURETTES

















## Volkman Curette

- 17cm/6¾" length

## Schede Curette

- 17cm/6¾" length



|  |  |  |  |
|--|--|--|--|
|  | <br><b>Fig. 0000</b> / 2.5mm<br>13-502-40 | <br><b>Fig. 2</b> / 8.5mm<br>13-503-02   |  |
|  | <br><b>Fig. 000</b> / 3.6mm<br>13-502-30  | <br><b>Fig. 3</b> / 10mm<br>13-503-03   | <br><b>Fig. 0</b> / 5.2mm<br>13-500-10   |
|  | <br><b>Fig. 00</b> / 4.4mm<br>13-502-20   | <br><b>Fig. 4</b> / 11.5mm<br>13-503-04 | <br><b>Fig. 1</b> / 6.8mm<br>13-501-01  |
|  | <br><b>Fig. 0</b> / 5.2mm<br>13-502-10    | <br><b>Fig. 5</b> / 13mm<br>13-503-05   | <br><b>Fig. 2</b> / 8.5mm<br>13-501-02  |
|  | <br><b>Fig. 1</b> / 6.8mm<br>13-503-01    | <br><b>Fig. 6</b> / 14.5mm<br>13-503-06 | <br><b>Fig. 3</b> / 10mm<br>13-501-03   |
|  |  |  | <br><b>Fig. 4</b> / 11.5mm<br>13-501-04 |

# BONE CURETTES



## Brunns Curette

- 17cm/6¾" length



○  
Fig. 0000/2.8mm  
13-504-40

○  
Fig. 000/3.3mm  
13-504-30

○  
Fig. 00/3.9mm  
13-504-20

○  
Fig. 0/4.7mm  
13-504-10

○  
Fig. 1/5.3mm  
13-505-01

○  
Fig. 2/6mm  
13-505-02

○  
Fig. 3/7.2mm  
13-505-03

○  
Fig. 4/8.2mm  
13-505-04

○  
Fig. 5/9.8mm  
13-505-05

○  
Fig. 6/12mm  
13-505-06

## Spratt Curette

- 17cm/6¾" length



○  
Fig. 0000/2.5mm  
13-506-40

○  
Fig. 000/2.8mm  
13-506-30

○  
Fig. 00/3.3mm  
13-506-20

○  
Fig. 0/3.7mm  
13-506-10

○  
Fig. 1/4.3mm  
13-507-01

○  
Fig. 2/4.8mm  
13-507-02

○  
Fig. 3/5.6mm  
13-507-03

○  
Fig. 4/6.1mm  
13-507-04

○  
Fig. 5/6.7mm  
13-507-05

# BONE CURETTES



## Brs Curette

- 27cm/10¾" length
- With Tufnol Handle

## Brun's Curette

- 23cm/9" length



○  
Fig. 000 /3.2mm  
13-514-30

○  
Fig. 00 /3.4mm  
13-514-20

○  
Fig. 0 /3.7mm  
13-514-10

○  
Fig. 1 /4.7mm  
13-515-01

○  
Fig. 2 /5.7mm  
13-515-02

○  
Fig. 3 /7mm  
13-515-03

○  
Fig. 4 /7.9mm  
13-515-04

○  
Fig. 5 /8.9mm  
13-515-05

○  
Fig. 6 /10.2mm  
13-515-06

○  
Fig. 000 /3.2mm  
14-514-30

○  
Fig. 00 /3.4mm  
14-514-20

○  
Fig. 0 /3.7mm  
14-514-10

○  
Fig. 1 /4.7mm  
14-515-01

○  
Fig. 2 /5.7mm  
14-515-02

○  
Fig. 3 /7mm  
14-515-03

○  
Fig. 4 /7.9mm  
14-515-04

○  
Fig. 5 /8.9mm  
14-515-05

○  
Fig. 6 /10.2mm  
14-515-06

# BONE CURETTES

## Uffendorde Curette

- 17cm/6" length

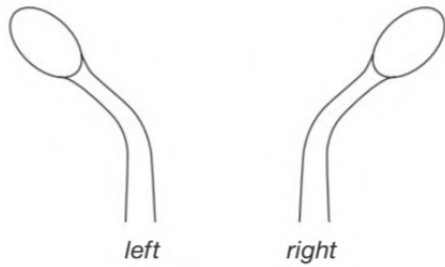

13-527-01

13-527-02

Left

Right



## Siebenmann Curette

- 16cm/6¼" length

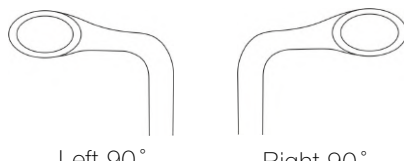

14-527-01

14-527-02



# BONE CURETTES



## Williger Curette

- 17.5cm/6¾" length



|   |   |
|---|---|
| ○<br><b>Fig. 00</b> /2.5mm<br>13-510-20 | ○<br><b>Fig. 00</b> /2.5mm<br>13-512-20 |
| ○<br><b>Fig. 0</b> /3.2mm<br>13-510-10  | ○<br><b>Fig. 0</b> /3.2mm<br>13-512-10  |
| ○<br><b>Fig. 1</b> /4mm<br>13-511-01    | ○<br><b>Fig. 1</b> /4mm<br>13-513-01    |
| ○<br><b>Fig. 2</b> /5.7mm<br>13-511-02  | ○<br><b>Fig. 2</b> /5.7mm<br>13-513-02  |

## Halle Curette

- 21cm/8¼" length

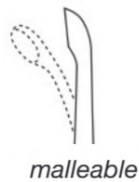

|  |
|--|
| ○<br><b>Fig. 1</b> /4.8mm<br>13-548-01 |
| ○<br><b>Fig. 2</b> /5.8mm<br>13-548-02 |
| ○<br><b>Fig. 3</b> /6.8mm<br>13-548-03 |



















# BONE CURETTES



## Mod. USA Curette

- 16cm/6¼" length









| Straight  | Left  | Right   |
|---|---|---|
| <br><b>Fig. 1</b><br>13-542-01   | <br><b>Fig. 1</b><br>13-543-01   | <br><b>Fig. 1</b><br>13-545-01   |
| <br><b>Fig. 2</b><br>13-542-02   | <br><b>Fig. 2</b><br>13-543-02   | <br><b>Fig. 2</b><br>13-545-02   |
| <br><b>Fig. 3</b><br>13-542-03   | <br><b>Fig. 3</b><br>13-543-03   | <br><b>Fig. 3</b><br>13-545-03   |
| <br><b>Fig. 4</b><br>13-542-04   | <br><b>Fig. 4</b><br>13-543-04   | <br><b>Fig. 4</b><br>13-545-04   |
| <br><b>Fig. 5</b><br>13-542-05   | <br><b>Fig. 5</b><br>13-543-05   | <br><b>Fig. 5</b><br>13-545-05   |
| <br><b>Fig. 6</b><br>13-542-06 | <br><b>Fig. 6</b><br>13-543-06 | <br><b>Fig. 6</b><br>13-545-06 |

## Simon Curette

- 24cm/9½" length



|   |
|---|
| <br><b>Fig. 1</b><br>13-540-01 |
| <br><b>Fig. 2</b><br>13-540-02 |
| <br><b>Fig. 3</b><br>13-540-03 |
| <br><b>Fig. 4</b><br>13-540-04 |
| <br><b>Fig. 5</b><br>13-540-05 |
| <br><b>Fig. 6</b><br>13-540-06 |

# HIP REVISION INSTRUMENTS





## Hatfield Curette

• 28cm/11" length





  
13-534-00  
3.0 x 5.0 mm

  
13-534-01  
3.5 x 5.5 mm

  
13-534-02  
4.5 x 6.4 mm

  
13-534-03  
5.0 x 8.0 mm

  
13-534-04  
5.0 x 8.0 mm

  
13-534-05  
7.0 x 11.0 mm

  
13-534-06  
8.5 x 12.5 mm

  
13-534-07  
9.5 x 14.5 mm

  
13-534-08  
10.5 x 16.8 mm

## Hatfield Curette

• 23cm/9" length





  
13-536-00  
3.0 x 5.0 mm

  
13-536-01  
3.5 x 5.5 mm

  
13-536-02  
4.5 x 6.4 mm

  
13-536-03  
5.0 x 8.0 mm

  
13-536-04  
6.0 x 9.0 mm

  
13-536-05  
7.0 x 11.0 mm

  
13-536-06  
8.5 x 12.5 mm

  
13-536-07  
9.5 x 14.5 mm

  
13-536-08  
10.5 x 16.8 mm

## Cobb Curette

• 28cm/11" length





  
13-538-00  
4.06 x 5.08 mm

  
13-538-01  
5.08 x 6.35 mm

  
13-538-02  
6.10 x 7.62 mm

  
13-538-03  
7.11 x 8.89 mm

  
13-538-04  
8.13 x 10.16 mm

  
13-538-05  
9.14 x 11.43 mm

  
13-538-06  
10.16 x 12.70 mm

  
13-538-07  
11.18 x 13.97 mm

  
13-538-08  
12.19 x 15.24 mm

# HIP REVISION INSTRUMENTS













## Volkman Curette

- 25cm/10" length













Straight jaw

|   |  |  |  |  |
|---|--|--|--|--|
|    |   |   |   |   |
| <b>Fig. 0000</b>  | <b>Fig. 000</b>  | <b>Fig. 00</b>   | <b>Fig. 0</b>  | <b>Fig. 1</b>  |
| 13-530-40   | 13-530-30  | 13-530-20  | 13-530-10  | 13-530-01  |
|  |  |  |  |  |
| <b>Fig. 2</b>   | <b>Fig.3</b>   | <b>Fig. 4</b>  | <b>Fig. 5</b>  | <b>Fig. 6</b>  |
| 13-530-02   | 13-530-03  | 13-530-04  | 13-530-05  | 13-530-06  |



Angled Jaw

|   |   |   |   |   |
|---|---|---|---|---|
|  |  |  |  |  |
| <b>Fig. 0000</b>  | <b>Fig. 000</b>   | <b>Fig. 00</b>  | <b>Fig. 0</b>   | <b>Fig. 1</b>   |
| 13-531-40   | 13-531-30   | 13-531-20   | 13-531-10   | 13-531-01   |
|  |  |  |  |  |
| <b>Fig. 2</b>   | <b>Fig.3</b>  | <b>Fig. 4</b>   | <b>Fig. 5</b>   | <b>Fig. 6</b>   |
| 13-531-02   | 13-531-03   | 13-531-04   | 13-531-05   | 13-531-06   |



# HIP REVISION INSTRUMENTS







## Volkman-Bruns Curette





- 23cm/9" length



Straight jaw





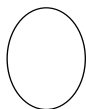





|   |   |   |   |   |
|---|---|---|---|---|
|  |  |  |  |  |
| <b>Fig. 0000</b>  | <b>Fig. 000</b>   | <b>Fig. 00</b>  | <b>Fig. 0</b>   | <b>Fig. 1</b>   |
| 13-532-40   | 13-532-30   | 13-532-20   | 13-532-10   | 13-532-01   |
| 3.0mm   | 3.3mm   | 3.9mm   | 4.7mm   | 5.3mm   |

|   |  |  |  |  |
|---|--|--|--|--|
|  |  |  |  |  |
| <b>Fig. 2</b>   | <b>Fig.3</b>   | <b>Fig. 4</b>  | <b>Fig. 5</b>  | <b>Fig. 6</b>  |
| 13-532-02   | 13-532-03  | 13-532-04  | 13-532-05  | 13-532-06  |
| 6.0mm   | 6.8mm  | 8.3mm  | 9.8mm  | 11.7mm   |



Angled Jaw

|   |   |   |   |   |
|---|---|---|---|---|
|  |  |  |  |  |
| <b>Fig. 0000</b>  | <b>Fig. 000</b>   | <b>Fig. 00</b>  | <b>Fig. 0</b>   | <b>Fig. 1</b>   |
| 13-533-40   | 13-533-30   | 13-533-20   | 13-533-10   | 13-533-01   |
| 3.0mm   | 3.3mm   | 3.9mm   | 4.7mm   | 5.3mm   |

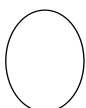
|   |   |   |   |   |
|---|---|---|---|---|
|  |  |  |  |  |
| <b>Fig. 2</b>   | <b>Fig.3</b>  | <b>Fig. 4</b>   | <b>Fig. 5</b>   | <b>Fig. 6</b>   |
| 13-533-02   | 13-533-03   | 13-533-04   | 13-533-05   | 13-533-06   |
| 6.0mm   | 6.8mm   | 8.3mm   | 9.8mm   | 11.7mm  |

# HIP REVISION INSTRUMENTS



## Cloward Hibbs Spratt Curette

- Spinal Fusion
- 22.5cm/9" length



Straight jaw



|                 |                |               |               |               |
|-----------------|----------------|---------------|---------------|---------------|
|                 |                |               |               |               |
| <b>Fig. 000</b> | <b>Fig. 00</b> | <b>Fig. 0</b> | <b>Fig. 1</b> | <b>Fig. 2</b> |
| 13-520-00       | 13-522-00      | 13-524-00     | 13-524-01     | 13-524-02     |
| 2x4mm           | 2.5x4.5mm      | 2.75x5.0mm    | 3x5.50mm      | 3.25x6mm      |

|               |               |               |               |
|---------------|---------------|---------------|---------------|
|               |               |               |               |
| <b>Fig. 3</b> | <b>Fig. 4</b> | <b>Fig. 5</b> | <b>Fig. 6</b> |
| 13-524-03     | 13-524-04     | 13-524-05     | 13-524-06     |
| 4x7mm         | 6x9.50mm      | 7x14mm        | 9x17mm        |



Angled Jaw

|                 |                |               |               |               |
|-----------------|----------------|---------------|---------------|---------------|
|                 |                |               |               |               |
| <b>Fig. 000</b> | <b>Fig. 00</b> | <b>Fig. 0</b> | <b>Fig. 1</b> | <b>Fig. 2</b> |
| 13-521-00       | 13-523-00      | 13-525-00     | 13-525-01     | 13-525-02     |
| 2x4mm           | 2.5x4.5mm      | 2.75x5.0mm    | 3x5.50mm      | 3.25x6mm      |

|               |               |               |               |
|---------------|---------------|---------------|---------------|
|               |               |               |               |
| <b>Fig. 3</b> | <b>Fig. 4</b> | <b>Fig. 5</b> | <b>Fig. 6</b> |
| 13-525-03     | 13-525-04     | 13-525-05     | 13-525-06     |
| 4x7mm         | 6x9.50mm      | 7x14mm        | 9x17mm        |

## Scoville Curette

- 25cm/10" length
- Bone Curette, 4mm



## Daubenspeck Curette

- 20cm/8" length



- **Fig.00**  
13-528-20
- **Fig.0**  
13-528-10
- **Fig. 1**  
13-529-01
- **Fig. 2**  
13-529-02



-   
Straight  
13-516-25
-   
Backward Angle  
13-517-25
-   
Forward Angle  
13-519-25

## Bushe Curette

- 25cm/10" length
- Bone Curette, 4mm



- **3mm**  
14-482-03
- **4mm**  
14-482-04
- **5mm**  
14-482-05
- **6mm**  
14-482-06

## Caspar Curette

### Zielke Curette

- Intervertebral
- Tufnol Handle



| • Straight |           |           |
|------------|-----------|-----------|
| Small      | Large     | Length    |
| 14-490-21  | 14-491-21 | 21cm/8¼"  |
| 14-490-35  | 14-491-35 | 35cm/13¾" |
| • Angled   |           |           |
| Straight   | Curved    | Length    |
| 14-492-25  | 14-492-25 | 25cm/10"  |



27cm/10¾"  
14-495-03  
3.0mm

27cm/10¾"  
14-495-04  
4.0mm

25cm/10"  
14-496-04  
4.0mm

25cm/10"  
14-496-05  
5.0mm



## ELEVATORS RASPATORIES

# PERIOSTEAL ELEVATORS & RASPATORIES



## Adson Periosteal Elevator

- 17cm/6¾" length

|   |           | Width |
|---|-----------|-------|
| A | 13-650-17 | 9mm   |
| B | 13-651-17 | 4mm   |
| C | 13-652-17 | 6mm   |
| D | 13-653-17 | 7mm   |



## Alexander

- Periosteotome, 12mm
- 20cm/8¼" length

13-634-20



## Lambotte Raspatory

- 21cm/8¼" length

|           | Width |
|-----------|-------|
| 13-627-10 | 10mm  |
| 13-627-15 | 15mm  |
| 13-627-20 | 20mm  |
| 13-627-25 | 25mm  |



## Farabeuf Rugine Elevator

- 15cm/6" length

| Straight* | Width |
|-----------|-------|
| 13-598-15 | 12mm  |

| Curved    | Width |
|-----------|-------|
| 13-599-15 | 12mm  |



\*illustrated

## Farabeuf Rugine Elevator with Hollow Handle

- 16cm/6¼" length

| Straight  | Width |
|-----------|-------|
| 13-658-16 | 12mm  |

| Curved*   | Width |
|-----------|-------|
| 13-659-16 | 12mm  |



\*illustrated

# PERIOSTEAL ELEVATORS & RASPATORIES



## Mcglamry

- 21cm/8¼" length

|           | Width |
|-----------|-------|
| 13-626-09 | 9mm   |
| 13-626-11 | 11mm  |
| 13-626-15 | 15mm  |
| 13-626-17 | 17mm  |



## Crego

- Elevator, 7mm
- 20cm/8" length

13-618-20



## Farabeuf-Collin

- Periosteal Raspatory
- 15.5cm/6¼" length

| Straight* | Width |
|-----------|-------|
| 13-582-15 | 11mm  |
| Curved    | Width |
| 13-583-15 | 11mm  |



\*illustrated

## Kraemer

- Raspatory, 10mm
- Round Blade
- 18.5cm/7¼" length

13-584-01



## Kraemer

- Raspatory, 10mm
- Straight Blade
- 18.5cm/7¼" length

13-584-02



# PERIOSTEAL ELEVATORS & RASPATORIES



Martin Langenbeck

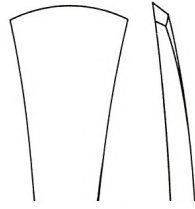

16mm

13-580-01

19cm/7½"

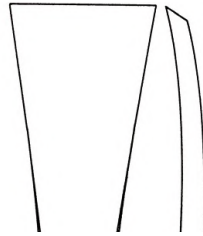

16mm

13-580-02

19cm/7½"

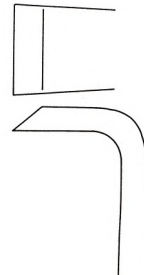

12mm

13-580-03

18.5cm/7¼"

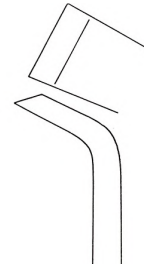

12mm

13-580-04

18cm/7"

Martin Hoen



Length

Width

13-580-10

16cm/6¼"

7mm

13-580-11

18.5cm/7¼"

15mm

13-580-12

20cm/8"

20mm

Martin Cushing

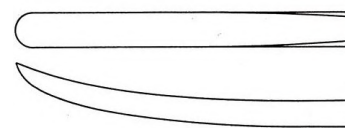

Length

Width

13-580-20

17cm/6¾"

4mm

13-580-21

17cm/6¾"

5mm

13-580-25

19.5cm/8"

6mm

13-580-26

19.5cm/8"

7mm

Martin Cushing

- 17cm/6¾" length
- Raspatory, 8mm



13-580-30





# PERIOSTEAL ELEVATORS & RASPATORIES



- 16cm/6¼" length



5mm

6mm

7mm

13-595-05

13-595-06

13-595-07

## Vickers

- 17cm/6¾" length

13-677-17



## Vickers

- 17cm/6¾" length

13-679-17



## Cohen

- Double sided
- 24cm/9½" length

13-688-24



## McDonald

- Double sided
- 19cm/7½" length

13-689-19



## Alderdyce

- Double Sided
- 21cm/8¼" length

13-687-21



# PERIOSTEAL ELEVATORS & RASPATORIES



## Doyen

- Rib Raspatory
- 17cm//6¾" length



Children, Left  
13-619-17



Children, Right  
13-621-17



Adult, Left  
13-623-17



Adult, Right  
13-625-17

# PERIOSTEAL ELEVATORS & RASPATORIES



## Semb

- Raspatory with hollow handle



**Fig. 1**

13-632-01

17.5cm/7"



**Fig. 2**

13-632-02

21cm/8¼"

13-630-01

18.5cm/7¼"

13-630-02

23cm/9"



**Fig. 3**

13-632-03

17.5cm/7"



**Fig. 4**

13-632-04

21cm/8¼"



**Fig. 5**

13-632-05

20.5cm/8"

13-630-03

18.5cm/7¼"

13-630-04

23cm/9"

13-630-05

21.5cm/8½"

# PERIOSTEAL ELEVATORS & RASPATORIES



## Langenbeck Elevator

- 19cm/7½" length

|           | Width |
|-----------|-------|
| 13-657-01 | 8mm   |
| 13-657-02 | 10mm  |



## Martin-Langenbeck Elevator

|           | Length   | Width |
|-----------|----------|-------|
| 13-667-01 | 17cm/6¾" | 5mm   |
| 13-667-02 | 17cm/6¾" | 7mm   |
| 13-667-03 | 20cm/8"  | 8mm   |
| 13-667-04 | 20cm/8"  | 10mm  |



## Williger (Blunt)

|           | Length   |
|-----------|----------|
| 13-661-17 | 17cm/6¾" |
| 13-663-16 | 16cm/6¼" |



## Cobb Elevator

- 

|           | Length   | Width |
|-----------|----------|-------|
| 13-670-01 | 28cm/11" | 9.5mm |
| 13-670-02 | 28cm/11" | 13mm  |
| 13-670-03 | 28cm/11" | 19mm  |
| 13-670-04 | 28cm/11" | 25mm  |
| 13-670-05 | 28cm/11" | 32mm  |



## Sebilaeu

- 17.5cm/7" length

|           |     |
|-----------|-----|
| 13-675-17 | 5mm |
|-----------|-----|



## Quervain

- 20cm/8" length

13-650-17

Width

6mm



## Cairns

- 17.5cm/6¾" length
- Bone Flap Elevator

13-654-16

Width

5mm

13-655-16

7mm



## Langenbeck Elevator

- 23cm/9" length
- Curved, 11mm

13-673-23



## Sedillot Raspatory

- 21cm/8¼" length
- Sharp, 15mm

13-597-21



# PERIOSTEAL ELEVATORS & RASPATORIES



## Raspatory

- 14cm/5½" length

13-631-01



## Raspatory

- 14cm/5½" length

13-631-02



## Langenbeck

- 18cm/7" length
- Periosteal Elevator, 14mm

13-591-18



## Langenbeck

- 19cm/7½" length
- Raspatory, 16mm

13-593-19



## Jansen

- 16.5cm/6½" length
- Periosteal Elevator

13-593-16



## Schneider

- 17.5cm/7" length
- Raspatory, 13mm

13-581-17



## Schneider-Sauerbruch

- 19cm/7½" length
- Raspatory, 13mm

13-581-19



# PERIOSTEAL ELEVATORS & RASPATORIES



## Williger Raspatory

- 13cm/5" length



Width

13-611-13

5mm

## Williger Raspatory

- 16cm/6¼" length
- Bone Flap Elevator



Width

13-613-16

5mm

## Matson

- 22cm/8¾" length

13-636-22

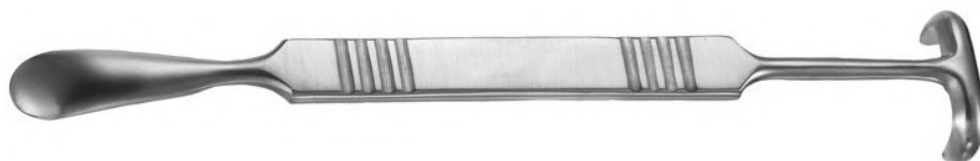

## Pennybacker Periosteal Elevator

- 16cm/6¼" length
- Curved sharp

Width

13-654-16

5mm

13-655-16

7mm



## Raspatory

- 17cm/6¾" length

Width

13-615-06

6mm

13-615-08

8mm



# PERIOSTEAL ELEVATORS & RASPATORIES



## Wagner

- Raspatory
- With Tufnol Handle
- 33cm/13" length

## Cobb

- Elevator, slightly curved
- 25cm/10" length

- Hip Raspatory, 21mm
- With Tufnol Handle
- 27.5cm/10¾" length

13-587-27



10mm

13-585-10

13mm

13-585-13

19mm

13-585-19

25mm

13-585-25



21



8mm

13-589-08

17mm

13-589-17



# PERIOSTEAL ELEVATORS & RASPATORIES



- Raspatory, 6mm
- With Tufnol Handle
- 18cm/7" length

13-604-18

- Raspatory, 3mm
- With Tufnol Handle
- 18cm/7" length

13-607-18

- Raspatory, 6mm
- With Tufnol Handle
- 18cm/7" length

13-605-18

- Raspatory, 6mm
- With Tufnol Handle
- 18cm/7" length

13-603-18



# PERIOSTEAL ELEVATORS & RASPATORIES



- Raspatory, 13mm
- With Tufnol Handle
- 18.5cm/7¼" length

13-606-18

- Raspatory, 14mm
- With Tufnol Handle
- 20cm/8" length

13-600-20

- Raspatory, 14mm
- With Tufnol Handle
- 19cm/7½" length

13-601-19

- Raspatory, 13mm
- With Tufnol Handle
- 23cm/9" length

13-608-18





## CHIESEL, GOUGES AND OSTEOTOMES

## Bone Chisel

- 13.5cm/5½" length

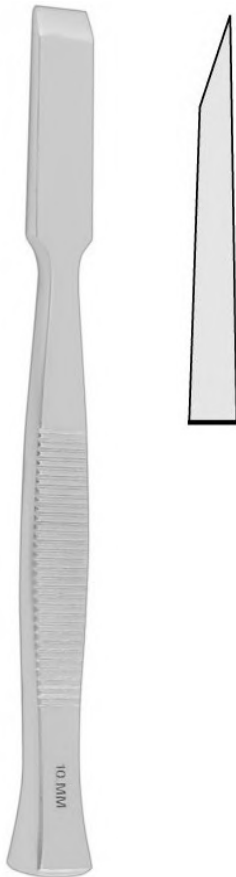

## Bone Osteotome

- 13.5cm/5½" length

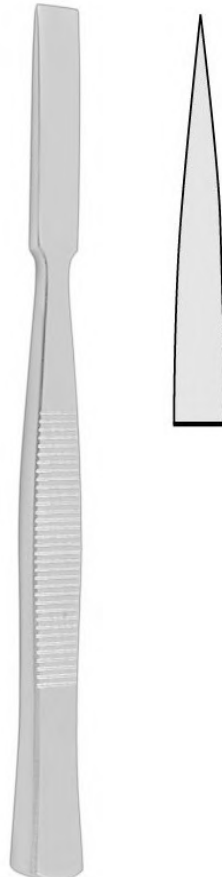

## Bone Gouge

- 13.5cm/5½" length

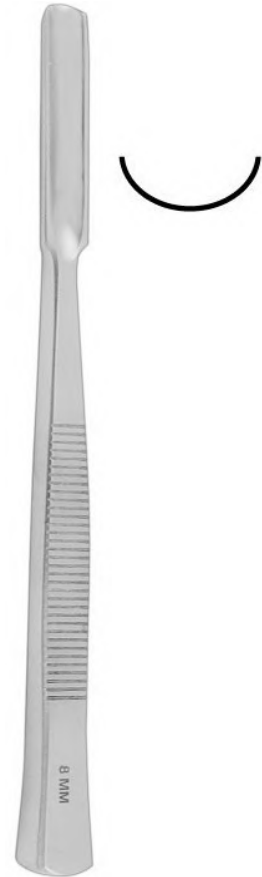

|           | Width |
|-----------|-------|
| 13-270-08 | 8mm   |
| 13-270-10 | 10mm  |
| 13-270-12 | 12mm  |
| 13-270-14 | 14mm  |
| 13-270-16 | 16mm  |

|           | Width |
|-----------|-------|
| 13-271-08 | 8mm   |
| 13-271-10 | 10mm  |
| 13-271-12 | 12mm  |
| 13-271-14 | 14mm  |
| 13-271-16 | 16mm  |

|           | Width |
|-----------|-------|
| 13-272-08 | 8mm   |
| 13-272-10 | 10mm  |
| 13-272-12 | 12mm  |
| 13-272-14 | 14mm  |
| 13-272-16 | 16mm  |

# OSTEOTOMES



## Hoke

- 16cm/6¼" length



Straight

Width

|           |     |
|-----------|-----|
| 13-350-03 | 3mm |
| 13-350-05 | 5mm |
| 13-350-06 | 6mm |
| 13-350-08 | 8mm |
| 13-350-09 | 9mm |



Curved

Width

|           |     |
|-----------|-----|
| 13-351-03 | 3mm |
| 13-351-05 | 5mm |
| 13-351-06 | 6mm |
| 13-351-08 | 8mm |
| 13-351-09 | 9mm |

## Mini-Lambotte Osteotome

- 12.5cm/4¾" length

Width

|           |      |
|-----------|------|
| 13-340-02 | 2mm  |
| 13-340-03 | 3mm  |
| 13-340-04 | 4mm  |
| 13-340-06 | 6mm  |
| 13-340-08 | 8mm  |
| 13-340-10 | 10mm |
| 13-340-12 | 12mm |
| 13-340-15 | 15mm |

Set of 8 sizes:  
2mm to 15mm

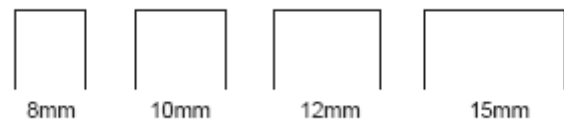
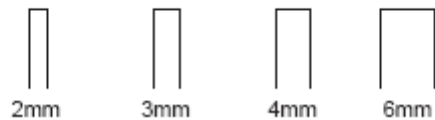

## Mini-Lambotte Osteotome

- 17cm/6¾" length

Width

|           |      |
|-----------|------|
| 13-342-02 | 2mm  |
| 13-342-03 | 3mm  |
| 13-342-04 | 4mm  |
| 13-342-06 | 6mm  |
| 13-342-08 | 8mm  |
| 13-342-10 | 10mm |
| 13-342-12 | 12mm |
| 13-342-15 | 15mm |

Set of 8 sizes:  
2mm to 15mm

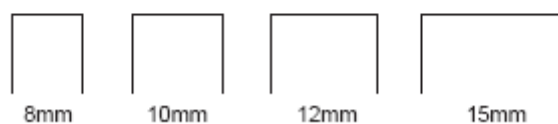

# OSTEOTOMES



## Lambotte Osteotome

- 24cm/9½" length

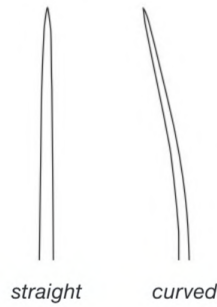

| Straight  | Width | Curved    | Width |
|-----------|-------|-----------|-------|
| 13-346-04 | 4mm   | 13-347-04 | 4mm   |
| 13-346-06 | 6mm   | 13-347-06 | 6mm   |
| 13-346-08 | 8mm   | 13-347-08 | 8mm   |
| 13-346-10 | 10mm  | 13-347-10 | 10mm  |
| 13-346-13 | 13mm  | 13-347-13 | 13mm  |
| 13-346-15 | 15mm  | 13-347-15 | 15mm  |
| 13-346-18 | 18mm  | 13-347-18 | 18mm  |
| 13-346-20 | 20mm  | 13-347-20 | 20mm  |
| 13-346-25 | 25mm  | 13-347-25 | 25mm  |
| 13-346-30 | 30mm  | 13-347-30 | 30mm  |
| 13-346-38 | 38mm  | 13-347-38 | 38mm  |
| 13-346-44 | 44mm  | 13-347-44 | 44mm  |
| 13-346-50 | 50mm  | 13-347-50 | 50mm  |

## Smith Petersen Osteotome

- 20cm/8" length

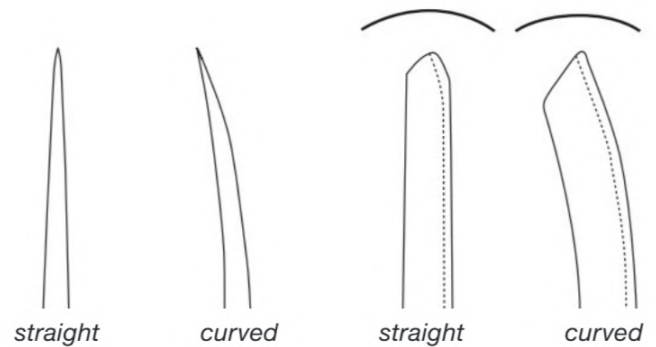

| Width | Osteotomes |           | Gouges    |           |
|-------|------------|-----------|-----------|-----------|
| 06mm  | 13-320-06  | 13-321-06 | 13-322-06 | 13-323-06 |
| 09mm  | 13-320-09  | 13-321-09 | 13-322-09 | 13-323-09 |
| 13mm  | 13-320-13  | 13-321-13 | 13-322-13 | 13-323-13 |
| 16mm  | 13-320-16  | 13-321-16 | 13-322-16 | 13-323-16 |
| 19mm  | 13-320-19  | 13-321-19 | 13-322-19 | 13-323-19 |
| 25mm  | 13-320-25  | 13-321-25 | 13-322-25 | 13-323-25 |
| 32mm  | 13-320-32  | 13-321-32 | 13-322-32 | 13-323-32 |

# OSTEOTOMES



## Partsch

- 13.5cm/5½" length

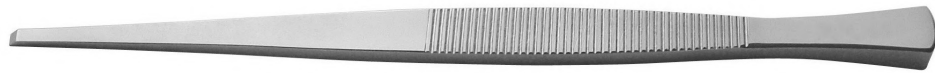

| Width | Chisels   | Gouges    |
|-------|-----------|-----------|
| 2mm   | 13-275-02 | 13-279-02 |
| 3mm   | 13-275-03 | 13-279-03 |
| 4mm   | 13-275-04 | 13-279-04 |
| 5mm   | 13-275-05 | 13-279-05 |
| 6mm   | 13-275-06 | 13-279-06 |

## Partsch

- 17cm/6¾" length



| Width | Chisels   | Gouges    |
|-------|-----------|-----------|
| 2mm   | 13-276-02 | 13-280-02 |
| 3mm   | 13-276-03 | 13-280-03 |
| 4mm   | 13-276-04 | 13-280-04 |
| 5mm   | 13-276-05 | 13-280-05 |
| 6mm   | 13-276-06 | 13-280-06 |

## Alexander

- 18cm/8" length



| Width | Chisels   | Gouges    |
|-------|-----------|-----------|
| 04mm  | 13-284-04 | 13-285-04 |
| 06mm  | 13-284-06 | 13-285-06 |
| 08mm  | 13-284-08 | 13-285-08 |
| 10mm  | 13-284-10 | 13-285-10 |
| 12mm  | 13-284-12 | 13-285-12 |
| 12mm  | 13-284-14 | 13-285-14 |

# OSTEOTOMES



## Stille

- 20cm/8" length



straight



straight



curved

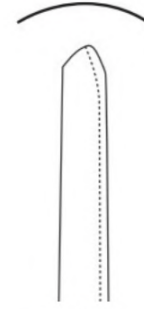

straight

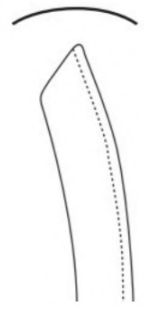

curved

| Width | Chisels   | Osteotomes |           | Gouges    |           |
|-------|-----------|------------|-----------|-----------|-----------|
| 10mm  | 13-293-10 | 13-294-10  | 13-295-10 | 13-296-10 | 13-297-10 |
| 15mm  | 13-293-15 | 13-294-15  | 13-295-15 | 13-296-15 | 13-297-15 |
| 20mm  | 13-293-20 | 13-294-20  | 13-295-20 | 13-296-20 | 13-297-20 |
| 25mm  | 13-293-25 | 13-294-25  | 13-295-25 | 13-296-25 | 13-297-25 |
| 30mm  | 13-293-30 | 13-294-30  | 13-295-30 | 13-296-30 | 13-297-30 |

## Hibbs Osteotome with thin blade

- 24cm/9½" length



straight



straight



curved

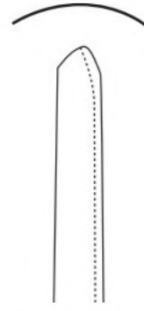

straight

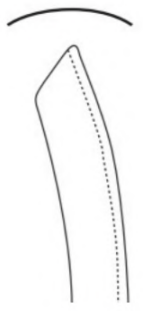

curved

| Width | Chisels   | Osteotomes |           | Gouges    |           |
|-------|-----------|------------|-----------|-----------|-----------|
| 06mm  | 13-333-06 | 13-334-06  | 13-335-06 | 13-336-06 | 13-337-06 |
| 13mm  | 13-333-13 | 13-334-13  | 13-335-13 | 13-336-13 | 13-337-13 |
| 19mm  | 13-333-19 | 13-334-19  | 13-335-19 | 13-336-19 | 13-337-19 |
| 25mm  | 13-333-25 | 13-334-25  | 13-335-25 | 13-336-25 | 13-337-25 |
| 32mm  | 13-333-32 | 13-334-32  | 13-335-32 | 13-336-32 | 13-337-32 |

## Cottle Osteotome

- 18.5cm/7¼" length



### Width

|           |      |
|-----------|------|
| 13-348-02 | 2mm  |
| 13-348-04 | 4mm  |
| 13-348-06 | 6mm  |
| 13-348-09 | 9mm  |
| 13-348-12 | 12mm |



# OSTEOTOMES



## Lexer

- 25cm/9¾" length
- Tufnol handle



| Straight  |       | Angled    |       |
|-----------|-------|-----------|-------|
|           | Width |           | Width |
| 13-300-05 | 5mm   | 13-301-05 | 5mm   |
| 13-300-10 | 10mm  | 13-301-10 | 10mm  |
| 13-300-15 | 15mm  | 13-301-15 | 15mm  |

## Lexer Osteotome

- 22cm/8¾" length
- Tufnol handle



| Width | Osteotomes | Gouges    |
|-------|------------|-----------|
| 07mm  | 13-304-07  | 13-305-07 |
| 10mm  | 13-304-10  | 13-305-10 |
| 15mm  | 13-304-15  | 13-305-15 |
| 20mm  | 13-304-20  | 13-305-20 |
| 25mm  | 13-304-25  | 13-305-25 |
| 30mm  | 13-304-30  | 13-305-30 |

## Dahmen Osteotome

- 30cm/12" length
- Tufnol handle



|  |      |
|--|------|
|  | 5mm  |
|  | 10mm |
|  | 15mm |
|  | 20mm |
|  | 25mm |
|  | 30mm |

| Straight  |      | Width |  |
|-----------|------|-------|--|
|           |      |       |  |
| 13-317-05 | 5mm  |       |  |
| 13-317-10 | 10mm |       |  |
| 13-317-15 | 15mm |       |  |
| 13-317-20 | 20mm |       |  |
| 13-317-25 | 25mm |       |  |
| 13-317-30 | 30mm |       |  |

| Angled    |      | Width |  |
|-----------|------|-------|--|
|           |      |       |  |
| 13-318-05 | 5mm  |       |  |
| 13-318-10 | 10mm |       |  |
| 13-318-15 | 15mm |       |  |
| 13-318-20 | 20mm |       |  |
| 13-318-25 | 25mm |       |  |
| 13-318-30 | 30mm |       |  |

# OSTEOTOMES



## Lexer

- 27.5cm/10¾" length
- Tufnol handle



| Osteotome | Width |
|-----------|-------|
| 13-306-10 | 10mm  |
| 13-306-15 | 15mm  |

| Gouge     | Width |
|-----------|-------|
| 13-307-10 | 10mm  |
| 13-307-15 | 15mm  |

# OSTEOTOMES



## Cobb

- 28cm/11" length
- Tufnol handle

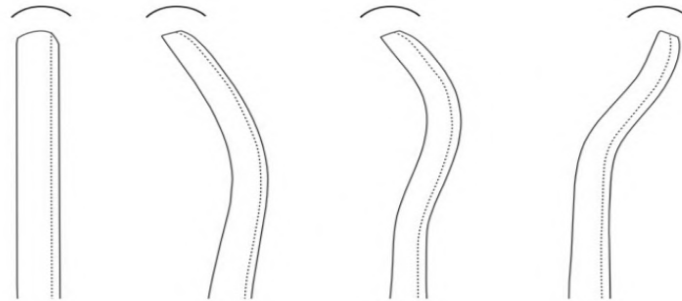

13-310-01

13-310-02

13-310-03

13-310-04

## Cobb

- 24cm/9½" length
- Hexagon handle
- gouge, 4mm



13-311-24

## Cobb

- 28cm/11" length
- Osteotome



13-311-28

## Box Chisel

- 29cm/11½" length
- For preparation of the proximal femur
- 31mm width x 6mm



13-343-29

# OSTEOTOMES



## Mini-Lexer Osteotome

- 18cm/7" length
- Tufnol handle



straight



straight



| Width | Osteotomes | Gouges    |
|-------|------------|-----------|
| 04mm  | 13-302-04  | 13-303-04 |
| 06mm  | 13-302-06  | 13-303-06 |
| 08mm  | 13-302-08  | 13-303-08 |
| 10mm  | 13-302-10  | 13-303-10 |
| 12mm  | 13-302-12  | 13-303-12 |

## Chisel with Interchangeable Blades

- 20cm/8" length
- Tufnol handle
- Very thin blades

13-345-20

Complete set with 4 blades & key



5mm



10mm



16mm



25mm

Chisels

13-344-05

13-344-10

13-344-16

13-344-25



5mm



10mm



16mm



25mm

Gouges

13-345-05

13-345-10

13-345-16

13-345-25

## Wrench

- 9cm/3½" length

13-345-00



# OSTEOTOMES



## Chisel, Straight

- 24.5cm/9½" length
- 20mm
- Tufnol handle



13-312-24



## Chisel, Curved

- 26.5cm/10½" length
- 16mm
- Tufnol handle



13-313-26



## Osteotome

- 20cm/8" length
- Tufnol handle



13-317-20

## Zielke

- 23cm/9" length
- Tufnol handle



Gouge      Width

13-315-05      5mm

13-315-09      9mm

# OSTEOTOMES & GOUGES



- Splitting Gouge, 9mm
- 22cm/8¾" length
- Tufnol handle

13-314-22



## Pelvic Osteotome

- 30cm/12" length
- Tufnol handle
- Angled shaft

15mm width

13-344-15

20mm width

13-344-20



- Lexer
- 28.5cm/11¼" length
- Tufnol handle

Gouge

Width

13-316-07

7mm

13-316-10

10mm



## Capener Lamina Gouge

- 23cm/9" length
- Cranked shaft

Width

13-349-06

6mm

13-349-08

8mm

13-349-11

11mm

13-349-16

16mm





# MALLETS AND TAMPS

# MALLETS



## Toffee Mallet

- 19cm/7½" length
- Head size 22mm Ø
- Weight 165g/6oz

13-401-19



## Ultra Fine Mallet

- 17cm/6¾" length
- Head size 20mm Ø
- Weight 145g/5oz

13-403-17



## Heath Mallet

- 19cm/7½" length
- Stainless steel head
- Head size 40mm Ø
- Weight 1020g/36oz

13-405-19



## Mallet with Tufnol Handle

- 22cm/8½" length
- **Small** head size 30mm Ø
- Weight **300g**/10¾oz

13-480-01

- **Medium** head size 35mm Ø
- Weight **500g**/17¾oz

13-480-02

- **Large** head size 40mm Ø
- Weight **600g**/21oz

13-480-03

- **Large** head size 40mm Ø
- Weight **940g**/33oz

13-480-04





# MALLETS



## London Splint Mallet

- 18cm/7" length
- Head size 30mm Ø
- Weight 450g/16.2oz

13-409-18



## Ombredanne Mallet

- 24cm/9½" length
- Head size 40mm Ø
- Weight 550g/20oz

13-404-24



## Mallet with Tufnol Handle

- 26cm/10¼" length
- Lead filled head
- Weight 400g/14oz

13-458-26



- 26cm/10¼" length
- Head size 42mm Ø

- Plastic, Lead Filled
- Weight 250g/8oz

13-456-01

- Ferrozell, Without Lead
- Weight 400g/14oz

13-456-02



# MALLETS

## Doyen Mallet

- 21cm/8¼" length

- **Small** head size 25mm Ø
- Weight **120g/4½oz**

13-408-01

- **Medium** head size 30mm Ø
- Weight **180g/6½oz**

13-408-02

- **Large** head size 35mm Ø
- Weight **260g/9oz**

13-408-03



Small



Medium



Large

## Collin Mallet

- 20cm/8" length
- Head size 30mm Ø
- Weight 220g/7¾oz

13-410-20



## Lucae Mallet

- 19cm/7½" length

- Head size 19mm Ø
- Weight **230g/8oz**

13-414-01

- Head size 25mm Ø
- Weight **260g/9oz**

13-414-02



19mm



25mm

## Cottle Mallet

- 19cm/7½" length
- Head size 30mm Ø
- Weight 240g/8½oz

13-430-19



# MALLETS



## Bergmann Mallet

- 23cm/9" length
- Head size 30mm Ø
- Weight 300g/10¾oz

13-402-23



## Bergmann Mallet

- 24cm/9½" length
- Head size 45mm Ø
- Weight 300g/10¾oz

13-400-24



## Williger Mallet

- 16.5cm/6½" length
- Stainless steel head
- Head size 20mm Ø
- Weight 140g/5oz

13-416-16



## Williger Mallet (Lead Filled)

- 24cm/9½" length
- **Small** head size 26mm Ø
- Weight **300g**/10½oz

13-406-01

- **Medium** head size 28mm Ø
- Weight **340g**/12oz

13-406-02

- **Large** head size 30mm Ø
- Weight **400g**/14oz

13-406-03



Small



Medium



Large

# MALLETS



## Hajek Mallet

- 22cm/8½" length
- Head size 27mm Ø
- Weight 140g/5oz

13-440-22



## Mead Mallet

- 17cm/6¾" length
- with interchangeable ferrozell faces
- Head size 26mm Ø (solid)
- Weight 320g/11¼oz

13-450-17

- Head size 26mm Ø (ferrozell faces)
- Weight 320g/11¼oz

13-451 17

-



## Mallet

26.5cm/6½" length

- Head size 30mm Ø
- Weight 450g/16oz

13-420-26

- Head size 50mm Ø
- Weight 900g/32oz

13-422-26



## Cloward Mallet

- 23cm/9" length
- Head size 19mm Ø
- Weight 215g

13-423-01

- 19cm/7½" length
- Head size 25mm Ø
- Weight 220g

13-423-02



# MALLETS



## Thiess Mallet

- 16.5cm/6½" length
- Head size 20mm Ø
- Weight 140g/5oz



Lead Filled

13-444-16

Brass/ Solid Filled

13-445-16

## Bergmann Mallet

- 26cm/10¼" length
- Head size 30mm Ø
- Weight 510g/18oz

13-448-26



- 24cm/9½" length
- Stainless steel head
- Head size 30mm/42mm Ø
- Weight 530g/19oz

13-424-24



- 18cm/7" length
- With two interchangeable heads
- Head size 26mm Ø
- Weight 140g/5oz

13-442-18



13-442-00

# MALLETS



## Partsch

- 18cm/7" length
- Head size 22mm Ø
- Weight 200g/7oz

13-454-18



## Wagner

- 23.5cm/9½" length
- Head size 35mm Ø
- Weight 140g/5oz

13-461-23



- Spare Faces, Pair

13-461-00



- Repercussion Free
- 26cm/10¼" length
- Head size 30mm Ø
- Weight 675g/23¾oz

13-460-26



- With Ferrozell Handle
- 26cm/10¼" length
- Head size 42mm/30mm Ø
- Weight 530g/19oz

13-462-26



# MALLETS

- 26cm/10¼" length
- Steel, Solid

- Head size 30mm Ø
- Weight 450g/16oz

13-470-01

- Head size 50mm Ø
- Weight 900g/32oz

13-470-02



- With ferrozell faces
- 22.5cm/9" length
- Head size 37mm Ø
- Steel, Solid
- Weight 370g/13oz

13-466-22



- Spare Faces, Pair

13-467-00



## Gerzog

- 19cm/7½" length
- Head size 30mm Ø
- Weight 300g/10¾oz

13-476-19



- For Hand Surgery
- 20cm/8" length
- Head size 18x18mm /7mm Ø
- Weight 80g/2¾oz

13-465-20



# MALLETS

## Steinbach

- 24cm/9½" length
- Head size 80x60mm Ø
- Weight 400g/14¼oz

13-432-24



## Gardner Mallet

- 14cm/5½" length
- Weight 280g/9¾oz

13-474-14





# TAMPS



## Bruenings

- Bone Temper
- 16cm/6¼" length

|           | ∅   |
|-----------|-----|
| 13-481-03 | 3mm |
| 13-481-05 | 5mm |
| 13-481-07 | 7mm |
| 13-481-09 | 9mm |



## Passow

- Bone Temper
- 12cm/4¾" length

|   |         |           |
|---|---------|-----------|
|  | 2.5mm ∅ | 13-482-25 |
|  | 3.5mm ∅ | 13-482-35 |



- Bone Temper
- 15cm/6" length
- Round Handle



|           | ∅   |           | ∅    |
|-----------|-----|-----------|------|
| 13-649-01 | 1mm | 13-649-05 | 5mm  |
| 13-649-02 | 2mm | 13-649-06 | 6mm  |
| 13-649-03 | 3mm | 13-649-08 | 8mm  |
| 13-649-04 | 4mm | 13-649-10 | 10mm |



- Bone Temper
- 15.5cm/6" length
- Round Handle



|           | ∅   |           | ∅    |
|-----------|-----|-----------|------|
| 13-648-02 | 2mm | 13-648-06 | 6mm  |
| 13-648-03 | 3mm | 13-648-08 | 8mm  |
| 13-648-04 | 4mm | 13-648-10 | 10mm |
| 13-648-05 | 5mm |           |      |



- Bone Temper
- 15.5cm/6" length

14-485-15



10mm



# TAMPS



- Bone Temper
- With ferrozell handle



## Straight, Serrated

|           |            |
|-----------|------------|
| 13-483-01 | 25.5cm/10" |
| 13-483-02 | 28cm/11"   |
| 13-483-03 | 31.5cm/12" |



## Straight, Smooth

|           |            |
|-----------|------------|
| 13-483-04 | 25.5cm/10" |
| 13-483-05 | 28cm/11"   |
| 13-483-06 | 31.5cm/12" |



Curved, Smooth



Straight, Serrated

## Curved, Smooth

|           |            |
|-----------|------------|
| 13-483-07 | 25.5cm/10" |
| 13-483-08 | 28cm/11"   |
| 13-483-09 | 31.5cm/12" |

- Bone Temper
- 28cm/11" length
- Round 17x7mm, Straight
- With ferrozell handle



13-484-28



- Bone Temper
- With ferrozell handle
- 35cm/13¾" length



19x14mm

13-485-14

15x10mm

13-485-10

# TAMPS



- Cement Temper
- Double Ended 7mm/3mm
- 23cm/9" length



13-486-23

## Caspar

- Bone Temper
- with synthetic handle
- 20cm/8" length

|           | Width |
|-----------|-------|
| 13-487-12 | 12mm  |
| 13-487-14 | 14mm  |
| 13-487-16 | 16mm  |



## Caspar

- Bone Temper
- with synthetic handle
- 20cm/8" length

|           | Width |
|-----------|-------|
| 13-487-03 | 3mm   |
| 13-487-05 | 5mm   |
| 13-487-08 | 8mm   |



## Sypert

- Bone Temper
- With ferrozell handle
- 29cm/11 1/2" length



|   |   |  |   |
|---|---|--|---|
|  |  |  |  |
| 3x8mm   | 4x10mm  | 5x15mm   | 6x20mm  |
| 13-489-08   | 13-489-10   | 13-489-15  | 13-489-20   |



## FILES AND RASPS

# FILES AND RASPS



## Fomon

- 21cm/8¼" length
- TC Rasp, 7x40mm
- Double Ended

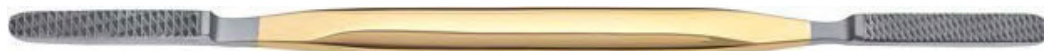

|           |              |
|-----------|--------------|
| 13-637-12 | Fig.1/Fig.2  |
| 13-637-34 | Fig.3/Fig.4  |
| 13-637-56 | Fig.5/Fig.6  |
| 13-637-78 | Fig.7/Fig.8  |
| 13-637-90 | Fig.9/Fig.10 |

## Parkes

- 21cm/8¼" length
- TC Rasp, 8x39mm
- Straight



|           |       |           |        |
|-----------|-------|-----------|--------|
| 13-638-01 | Fig.1 | 13-638-06 | Fig.6  |
| 13-638-02 | Fig.2 | 13-638-07 | Fig.7  |
| 13-638-03 | Fig.3 | 13-638-08 | Fig.8  |
| 13-638-04 | Fig.4 | 13-638-09 | Fig.9  |
| 13-638-05 | Fig.5 | 13-638-10 | Fig.10 |

## Maltz

- 16.5cm/6½" length
- TC Rasp



|           |       |
|-----------|-------|
| 13-639-02 | Fig.2 |
| 13-639-03 | Fig.3 |
| 13-639-04 | Fig.4 |
| 13-639-05 | Fig.5 |
| 13-639-06 | Fig.6 |

## Aufricht

- 20cm/7¾" length
- Rasp 7x25mm
- Fine, Curved
- Diamond Jaws



13-641-20

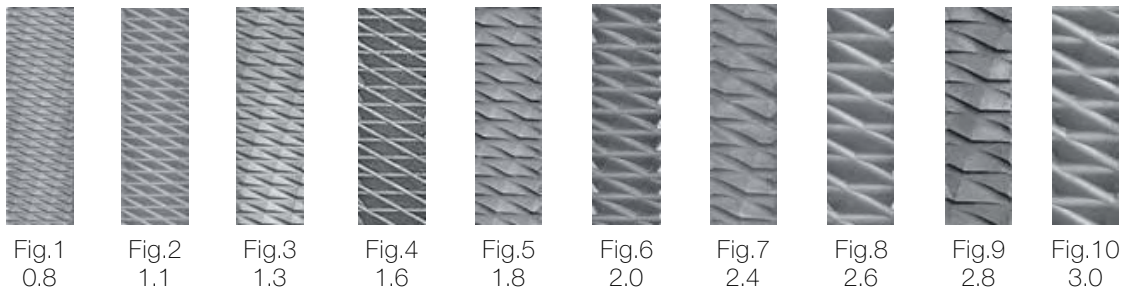
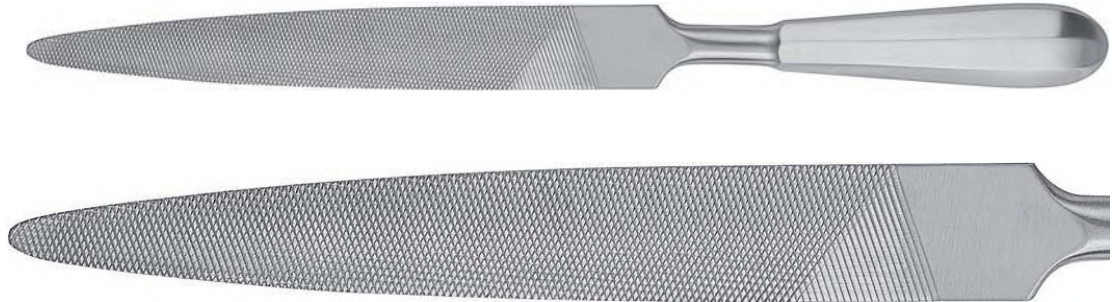

Fig.1 0.8    Fig.2 1.1    Fig.3 1.3    Fig.4 1.6    Fig.5 1.8    Fig.6 2.0    Fig.7 2.4    Fig.8 2.6    Fig.9 2.8    Fig.10 3.0

# FILES AND RASPS

- Bone File with hollow handle
- Semi Round
- 28cm/11" length

13-640-28



- Bone File, Bayonet Shaped
- 24.5cm/9½" length

13-642-24



- Bone File/ Rasp
- 22cm/8¾" length

13-644-22



## Fomon

- 21cm/8¼" length
- TC Rasp, 7x40mm
- Double Ended

13-643-21



## Fomon

- 20cm/7¾" length
- Rasp 7x25mm
- Fine, Curved
- Diamond Jaws

13-645-20



## Fomon

- 21cm/8¼" length
- TC Rasp, 7x40mm
- Double Ended

13-646-21



## Kleinert-Kutz

- 22cm/8¾" length
- Rasp, 4Sides
- Double Ended

13-647-22

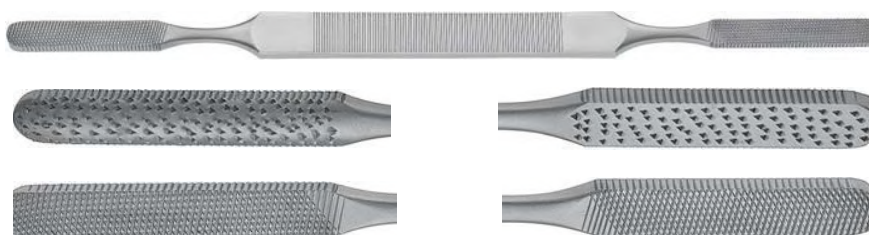

# FILES AND RASPS



## Miller

- 21cm/8¼" length
- 90° Cross Serrated
- Cut on down stroke



|           |       |         |
|-----------|-------|---------|
| 14-649-01 | Fig.1 | 8mm/5mm |
| 14-649-02 | Fig.2 | 6mm/4mm |
| 14-649-03 | Fig.3 | 6mm/5mm |



## Putti

- 30cm/11¾" length
- Bone File



14-650-30

## Putti

- 27cm/10¾" length
- Bone File



14-651-27

## Gallaher

- 17cm/6¾" length
- Rasp with ring
- Coarse



14-653-17



# FILES AND RASPS

## Aufricht

- 22cm/8¾" length
- Rasp, 90° Cross Serrated

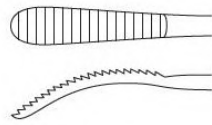

14-654-22

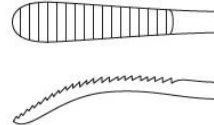

14-655-22

## Joseph

- 16.5cm/6½" length
- Rasp, Cross Serrated



|           |        |
|-----------|--------|
| 14-656-16 | Fine   |
| 14-657-16 | Coarse |

## Lewis

- 17.5cm/7" length
- Rasp, Set to cut
- On down stroke

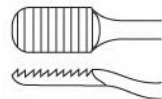

Fine

14-658-17

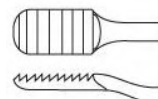

Coarse

14-659-17

## Maltz

- 18cm/7" length
- Rasp, Straight



Backward Cutting

14-661-18

14-661-18/TC

Forward Cutting

14-662-18

14-662-18/TC

## Maltz (Cottle)

- 21cm/8¼" length
- Rasp, Backward cutting



14-664-21





## BONE RONGEUR

# BONE RONGEURS



## Kleinert-Kutz Bone Nibbler

- 14cm/5½" length
- Curved

2mm Bite

13-842-02



## Lempert Bone Nibbler

- 19cm/7½" length
- Single action

3mm Bite

13-864-19



3mm Bite

13-865-19



## Lempert Bone Nibbler

- 16cm/6¼" length
- Single action

3mm Bite

13-864-16



3mm Bite

13-865-16



## Adsons Bone Nibbler

- 20cm/8" length
- Single action

7mm Bite

13-878-20

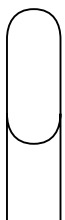

7mm Bite

13-879-20



# BONE RONGEURS



## Stellbrink

- 17cm/6¾" length
- Light Curved

13-841-01



## Stellbrink

- Synovectomy Rongeur
- 16.5cm/6½" length
- Strong Curved

13-841-02



## Mini-Friedmann

- 12cm/4¾" length
- delicate jaw, 1.1mm

13-843-12



## Defourmental

- 19cm/7½" length

13-874-19



# BONE RONGEURS



## Friedmann

- 14cm/5½" length

13-845-14



## Friedmann-Mini

- 15cm/6" length
- 90° Curved

13-846-01

- 14cm/5½" length
- 90° Curved

13-846-02



## Hakansson

- 17cm/6¾" length

13-850-17



## Cleveland

- 14cm/5½" length

13-851-14

- 17cm/6¾" length

13-853-17



# BONE RONGEURS



## Mead

- 16.5cm/6½" length
- Round Jaw

13-855-16



- 16.5cm/6½" length
- Square Jaw

13-856-16

## Beyer

- 18cm/7" length

13-857-18

- 17cm/6¾" length
- 2mm

13-858-02

- 17cm/6¾" length
- 3mm

13-858-03



## Hartmann

- 18.5cm/7¼" length

13-859-18



## Luer

- 15cm/6" length



13-875-15

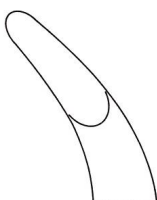

13-876-15

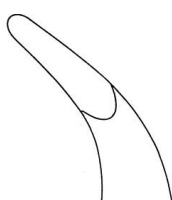

13-877-15



# BONE RONGEURS



## Luer

- 18cm/7" length
- 13x8mm wide jaw

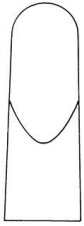

13-872-18



13-873-18



## Jansen

- Curved double action
- 18cm/7" length /4mm Bite



Straight  
13-860-18



Light Curve  
13-861-18



Strong Curve  
13-863-18



## Blumenthal



Curved  
15cm/6" length  
13-866-15



45°  
14.5cm/5¾" length  
13-867-14



90°  
14cm/5½" length  
13-869-14



# BONE RONGEURS



## Universal

- 13.5cm/5¼" length

13-870-13



## Olivecrona

- 20cm/8" length
- 5mm wide jaw

13-871-20



## Bane

- 18cm/7" length

13-892-01





# BONE RONGEURS



## Guleke

- 20.5cm/8" length

13-892-05



## Jansen

- 19cm/7½" length
- 4mm wide jaw

13-892-04

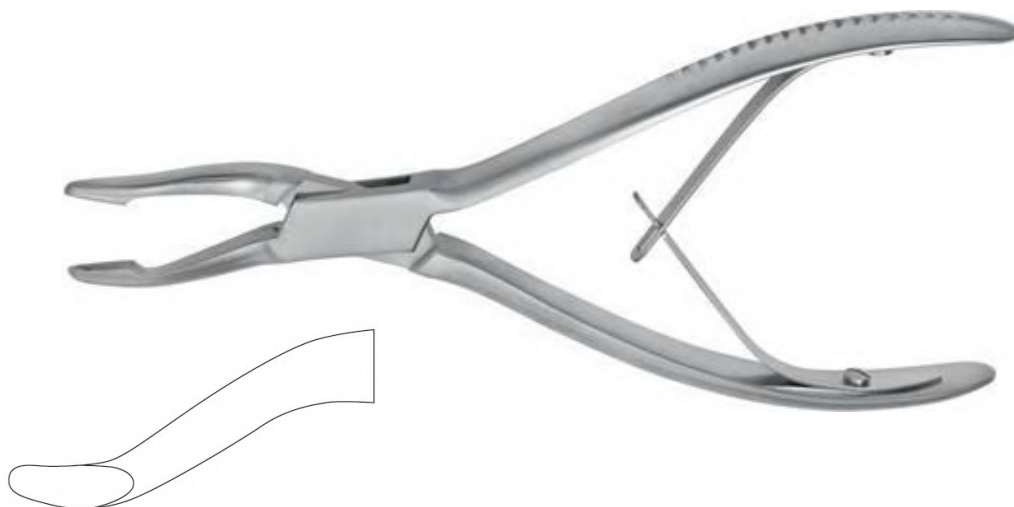

## Wilms

- 20cm/8" length
- 4mm wide jaw

13-892-07



## Trotter

- 20cm/8" length
- 7mm wide jaw

13-892-08



# BONE RONGEURS



## Bohler Bone Nibbler

- Curved double action
- 15cm/6"



| Straight  | Curved    | Bite Size |
|-----------|-----------|-----------|
| 13-880-15 | 13-881-15 | 3mm       |
| 13-880-02 | 13-881-02 | 2mm       |

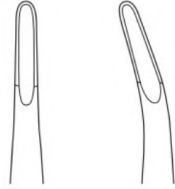

straight

curved

## Marquardt Bone Nibbler

- 20cm/8" length
- Curved double action



3mm Bite  
13-889-20

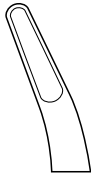

## Beyer Bone Nibbler

- Curved double action
- 18cm/7" length



4mm Bite  
13-889-18

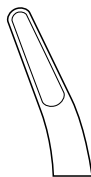

## Zaufel Jansen

- Curved double action
- 18cm/7" length /4mm Bite



13-885-18

# BONE RONGEURS



## Mayfield

- Curved, 4mm
- 17cm/6¾"

13-887-17



## Ruskin

- 19cm/7½" length
- Straight

13-890-18

- Curved

13-891-18



## Ruskin

- 23cm/9" length
- Straight, 5mm

13-890-23

- Curved, 5mm

13-891-23



## Kleinert-Kutz

- 15cm/6" length



13-897-01



13-897-02



# BONE RONGEURS



## Smith-Peterson Bone Nibbler

- 24cm/9½" length
- Double action

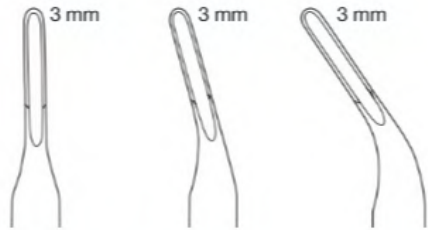

*straight*

*slightly curved*

*curved*

13-902-01

13-902-02

13-902-03



## Ruskin-Mini

- 15cm/6" length
- Straight, 2mm

13-898-02

- Curved, 2mm

13-899-02

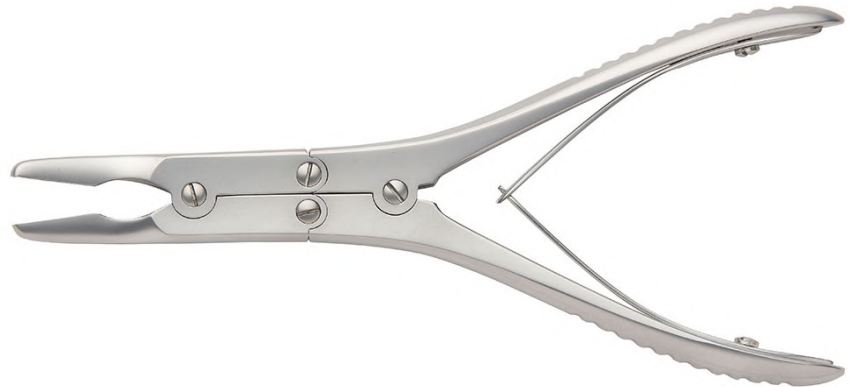

## Ruskin-Mini

- 15cm/6" length
- Straight, 3mm

13-898-15

- Curved, 3mm

13-899-15



## Rz Cera-Cut Rongeur

- More durable
- Longer Resistance

14-900-15



# BONE RONGEURS



## Leksell Bone Nibbler

- 24cm/9½" length
- Double action angled



Angled Jaw      Bite Size

|           |     |
|-----------|-----|
| 13-908-24 | 8mm |
| 13-910-24 | 5mm |
| 13-912-24 | 3mm |

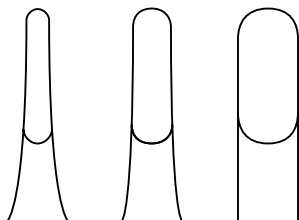

3mm      5mm      8mm

## Stille-Luer Bone Nibbler

- 22cm/8¾" length
- Double action

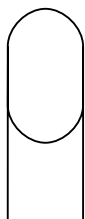

Straight  
10mm Bite

13-916-22



Curved  
10mm Bite

13-917-22



## 'Mr Blobby' Stille-Luer Bone Nibbler

- Double action

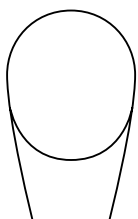

Straight  
10mm Bite

13-926-27

27cm/10¾"

13-926-23

23cm/9"

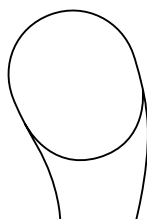

Curved  
10mm Bite

13-927-27

27cm/10¾"

13-927-23

23cm/9"



# BONE RONGEURS



Sauerbruch  
30cm/12"length



Straight, Angular  
13-930-30

Straight, Round  
13-932-30

Sypert  
• 35cm/14" length



| Code      | Bite Size |
|-----------|-----------|
| 13-936-08 | 8mm       |
| 13-936-05 | 5mm       |
| 13-936-03 | 3mm       |

Dale  
• 35cm/14" length



| Code      | Bite Size |
|-----------|-----------|
| 13-937-08 | 8mm       |
| 13-937-03 | 3mm       |

# BONE SPREADERS



## Scaphoid Spreader - Fine Pattern

- 14cm/5½" length
- 1 x 2 prongs

6mm

13-836-14



## Scaphoid Spreader - Standard Pattern

- 14cm/5½" length

6mm

13-840-14



## Baby Inge Bone Spreader

- 18cm/7" length

7mm  
Toothed



13-831-18

7mm  
Smooth



13-831-18S

7mm  
Cross Serrated



13-831-18X



## Scaglietti Lamina Spreader

- 28cm/11" length
- With speed lock

13-833-08

6 mm



8 mm



13-833-10

6 mm



10 mm



13-833-12

6 mm



12 mm





## **BONE CUTTING**



# BONE CUTTERS



## Bohler Bone Cutters

- 15cm/6" length
- Double action

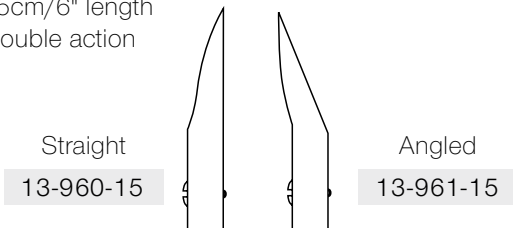

## McIndoe Bone Cutters

- 17.5cm/6¾" length
- Double action
- Angled jaws

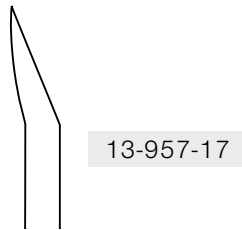

## Stille-Liston Bone Cutters

- 27cm/10¾" length
- Double action

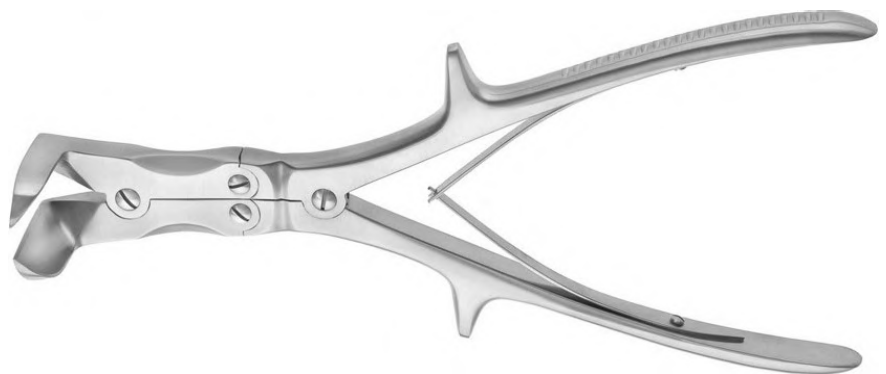

## Stille-Liston Bone Cutters

- 23cm/9" length
- Double action

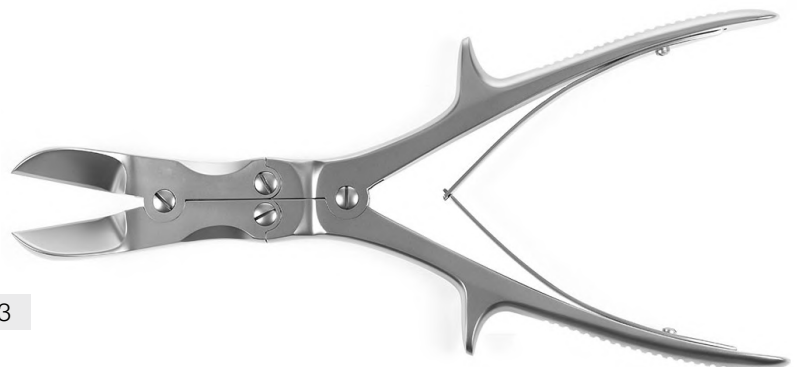
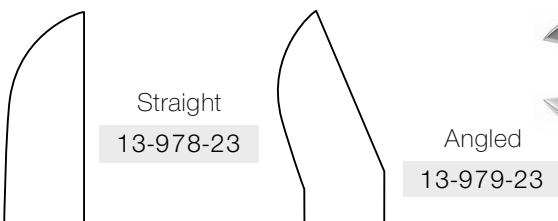

## Stille-Liston Bone Cutters

- 27cm/10¾" length
- Double action



# BONE CUTTERS



## Ruskin-Liston Bone Cutters

- 18cm/7" length
- Double action

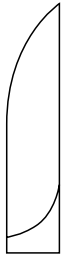

Straight

13-954-18



Angled

13-955-18



## Kleinert-Kutz

- 15cm/6" length

Straight

13-952-15

Angled

13-953-15



## Markwalder

- 20cm/8" length

13-943-20



## Liston

Straight

13-946-14

13-846-17

13-946-19

13-946-22

Curved

13-947-14

13-947-17

13-947-19

13-947-22

Length

14cm/5½"

17cm/6¾"

19cm/7½"

22cm/8¾"



# BONE CUTTERS



## Cleveland

- 15cm/6" length

13-951-15



---

## Cleveland

- 17cm/6¾" length

13-951-17



---

## Cleveland Gardner

- 16cm/6¼" length

13-941-16



# BONE CUTTERS



## Littauer-Liston

- 15cm/6" length

Straight  
13-948-15



## Cutter

- 12cm/4¾" length

13-965-12



## Cottle Kazanjian

19cm/7½" length  
Straight

13-940-19



# BONE CUTTERS



## Walton-Liston

- 15cm/6" length



Straight  
13-962-15

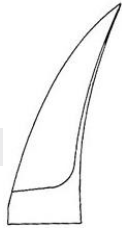

Angled  
13-963-15



## Semb

- 24cm/9½" length

13-973-24

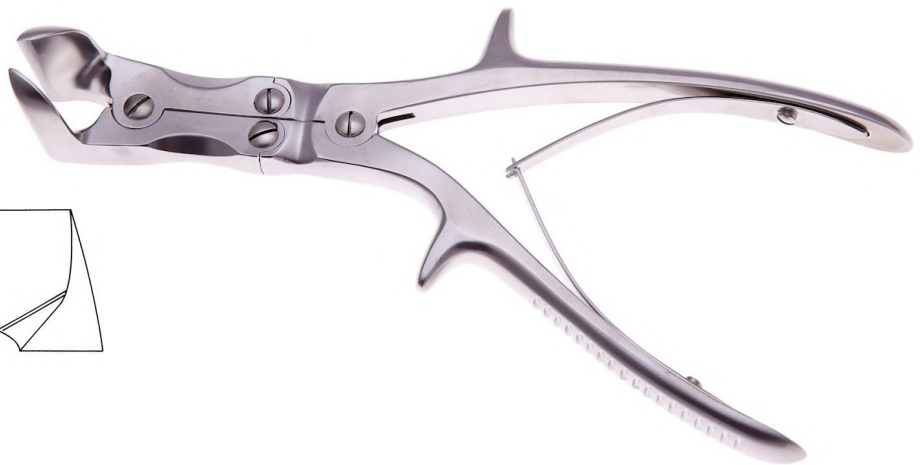
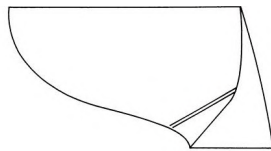

## Liston-Key-Horsley Bone Cutters

- 27cm/10¾" length
- Double actor
- Angled



13-972-27





# PLASTER CAST INSTRUMENTS

# PLASTER CAST



Empire

## Lister

- Bandage Scissors

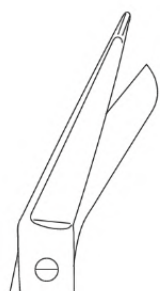

9cm/7½" length

14-711-09

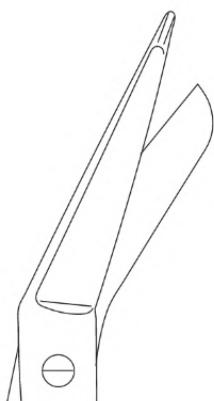

11cm/4½" length

14-711-11

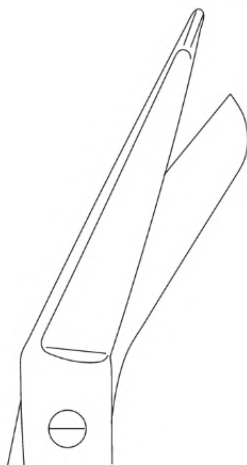

14cm/5½" length

14-711-14

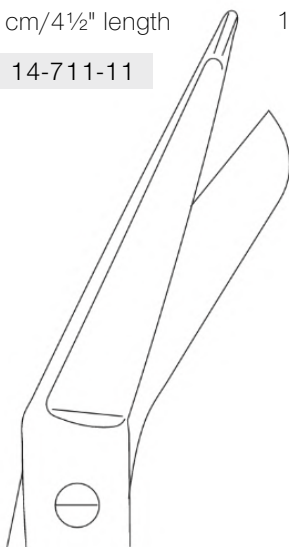

18cm/7" length

14-711-18

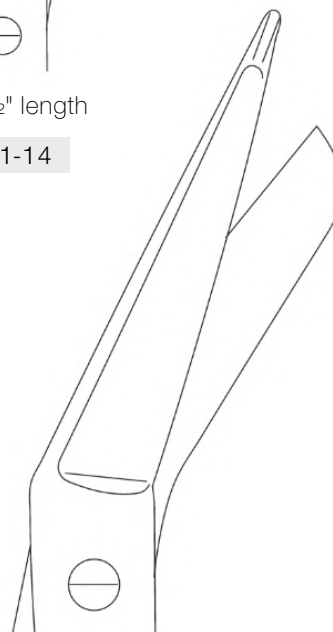

20cm/8" length

14-711-20

## Lister

- Bandage Scissors
- 18cm/7" length

14-712-18

TC

14-713-18

Super-Cut



# PLASTER SCISSORS



Empire

## Lister

- Bandage Scissors
- Large Bow

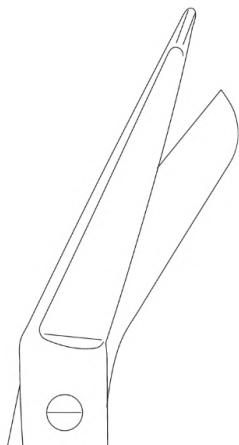

### Length

|           |  |
|-----------|--|
| 14-714-18 | 18.5cm/7 <sup>3</sup> / <sub>4</sub> " |
| 14-714-20 | 20cm/8"                                |

## Lister-Excentric

- Bandage Scissors
- Serrated

### Length

|           |                                      |
|-----------|--------------------------------------|
| 14-716-16 | 16cm/6 <sup>1</sup> / <sub>4</sub> " |
| 14-716-19 | 19cm/7 <sup>1</sup> / <sub>2</sub> " |



## Esmarch

- Plaster Scissors

### Length

|           |                                      |
|-----------|--------------------------------------|
| 14-718-20 | 20cm/8"                              |
| 14-718-22 | 22cm/8 <sup>3</sup> / <sub>4</sub> " |





# PLASTER SCISSORS



## Bergmann

- Plaster Scissors
- 23cm/9" length

14-720-23



## Sevlin

- Cloth and Plaster Scissors
- Serrated
- 23cm/9" length

14-722-23



- Cloth Scissors
- Serrated
- 20cm/8" length

14-724-20



## Smith (Med. USA)

- Bandage Scissors

|           | Length  |
|-----------|---------|
| 14-726-18 | 18cm/7" |
| 14-726-23 | 23cm/9" |



# PLASTER SCISSORS

## Lorenz

- bandage Scissors, Curved
- 23cm/9" length

14-728-23



## Bruns

- Plaster Scissors
- 24cm/9½" length

14-730-24

Serrated

14-731-24

Smooth



## Knowles

- Bandage Scissors
- 14cm/5½" length

14-732-14

Straight

14-733-14

Angled



## Knowles

- Bandage Scissors, Knee angled shaft
- 14cm/5½" length

14-734-14



# PLASTER SCISSORS



## Universal

- Plaster and Cloth Scissors
- With Protection Cup
- With Plastic Rings, Auto Clavable



Additional Available Ring Colors

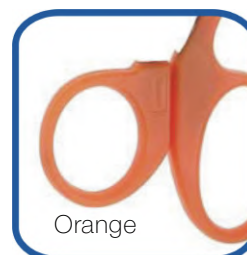

15.5cm/6" length

|           |        |
|-----------|--------|
| 21-206-15 | Blue   |
| 21-207-15 | Orange |
| 21-208-15 | Red    |
| 21-209-15 | Black  |
| 21-210-15 | Green  |
| 21-211-15 | yellow |

18.75cm/7½" length

|           |        |
|-----------|--------|
| 21-206-18 | Blue   |
| 21-207-18 | Red    |
| 21-208-18 | Orange |
| 21-209-18 | Black  |
| 21-210-18 | Green  |
| 21-211-18 | yellow |

# PLASTER SCISSORS

## Universal

- Plaster and Cloth Scissors
- With Protection Splint
- With Plastic Rings, Auto Clavable
- 14cm/5½" length



Additional Available  
Ring Color



Pink

|           |      |
|-----------|------|
| 14-740-01 | Blue |
| 14-740-02 | Pink |



# PLASTER SCISSORS



## Mini-Stille

- Plaster Cast Scissors
- 18cm/7" length

14-742-18



## Stille

- Plaster Cast Scissors
- 24cm/9½" length

14-743-24



# PLASTER SCISSORS



## Stille

- Plaster Cast Scissors

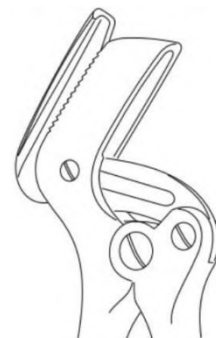

23cm/9" length

14-744-23



26cm/10¼" length

14-744-26



37cm/14½" length

14-744-37

| Spare Blade | For       |
|-------------|-----------|
| 14-745-01   | 14-744-23 |
| 14-745-02   | 14-744-26 |
| 14-745-03   | 14-744-37 |

# PLASTER CAST SPREADERS



## Lorenz

- Plaster Cast Spreader
- Single Hand Model
- 23cm/9" length

14-747-23



## Henning

- Plaster Spreader
- 28cm/11" length

14-748-28



## Beeson

- Plaster Spreader
- 30cm/12" length

14-749-30



## Hermann

- Plaster Spreader
- 48cm/19" length

14-750-48



## Wold-Boehler

- Plaster Cast Breaker

|           | Length   |
|-----------|----------|
| 14-751-18 | 18cm/7"  |
| 14-751-24 | 24cm/9½" |



# PLASTER KNIVES AND SAWS



## Hopkin

- Plaster Knife
- 20cm/8" length

14-752-20



## Esmarch

- Plaster Knife
- 18cm/7" length

14-753-18



## Reiner

- Plaster Knife
- 18.5cm/7¼" length

14-754-18



## Bergmann

- Plaster Cast Saw
- 24cm/9½" length

14-755-24



## Engel

- Plaster Saw
- 15cm/6" length

14-756-15







# AMPUTATION

# AMPUTATION

## Cottle

- Amputating Knife



Blade Length

|           |          |
|-----------|----------|
| 14-765-13 | 13cm/5"  |
| 14-765-16 | 16cm/6¼" |
| 14-765-19 | 19cm/7½" |
| 14-765-22 | 22cm/8¾" |
| 14-765-28 | 28cm/11" |

## Catlin

- Amputating Knife
- Double Cutting



Blade Length

|           |          |
|-----------|----------|
| 14-766-16 | 16cm/6¼" |
| 14-766-19 | 19cm/7½" |
| 14-766-22 | 22cm/8¾" |

- Phalangeal Knife
- 30cm/12" length



14-768-30

## Interosseous Knife

- 11cm/7" working length



14-769-11



## Walb

- Organ Knife
- With wooden handles

Blade Length

|           |          |
|-----------|----------|
| 14-771-11 | 11cm/7"  |
| 14-771-14 | 14cm/9½" |
| 14-771-17 | 17cm/9½" |



# AMPUTATION

## Helferich B

- Amputation Saw
- 39cm/15½" length

14-775-39



Spare Blade

14-775-04 4mm

14-775-06 6mm

14-775-08 8mm

## Charriere

- Amputation Saw



Length

13-112-27 27cm/10½"

13-112-30 30cm/12"

## Satterlee

- Amputation Saw
- 31cm/12¼" length

13-114-31



## Langenbeck

- Metacarpal Saw
- 23cm/9" length

13-110-23



# AMPUTATION



## Charriere

- Amputation Saw
- 35cm/14" length

13-100-35



### Spare Blade

|           |      |
|-----------|------|
| 13-100-12 | 12mm |
| 13-100-15 | 15mm |
| 13-100-18 | 18mm |

## Rust

- Amputation Saw
- 39cm/15¼" length

14-784-39



### Spare Blade

|           |      |
|-----------|------|
| 14-784-01 | 12mm |
| 14-784-02 | 15mm |
| 14-784-03 | 18mm |

# AMPUTATION



## Percy

- Amputating Retractor
- With Removable Handle

13-838-30



---

## Percy

- Amputating Retractor
- With Stowable Handle

13-838-50





## MEASURING DEVICES

## Stainless Steel Measuring Ruler

- Ruler with mm and inch marking

| Code     | Length   |
|----------|----------|
| EM-RU-04 | 15cm/6"  |
| EM-RU-08 | 30cm/12" |



## Depth Gauge

- 



|           |       | Measuring depth |
|-----------|-------|-----------------|
| 33-700-00 | Mini  | up to 40mm      |
| 33-704-00 | Small | up to 70mm      |
| 33-708-00 | Large | up to 110mm     |

## Measuring Caliper

- 25cm/10" length
- Measuring range 0-50mm

14-789-25



## Moeltgen

- Goniometer

01-260-01



# MEASURING INSTRUMENTS



## Direct Reading Depth Gauge

- 23cm length
- Measuring depth up to 40mm

14-790-23



## Castroviejo

- Caliper
- Measuring range 0-20mm
- With locking screw
- 90mm

27-304-06



## Castroviejo

- Caliper
- Measuring range 0-20mm
- With locking screw
- 90mm

27-304-06



## Carrol

- Finger Goniometer
- 25cm/10" length

01-220-14





## Caspar

- Calliper for measuring bone craft
- Scale in mm, max 180mm
- Inside/Outside measuring, faces & depth

14-792-18

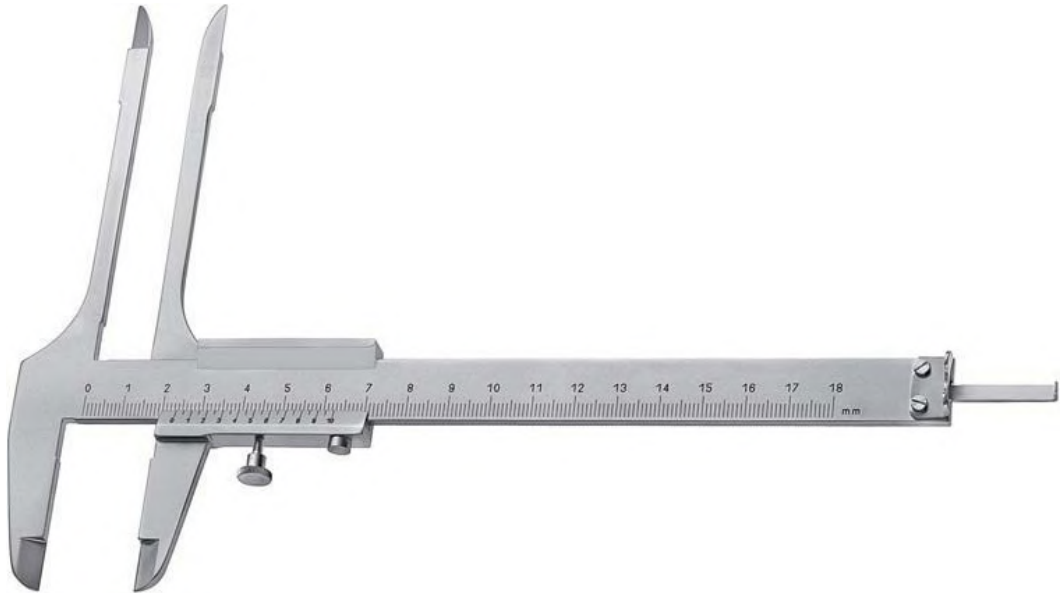

---

## Neuro Caliper

- Scale in mm, max 180mm

14-793-18

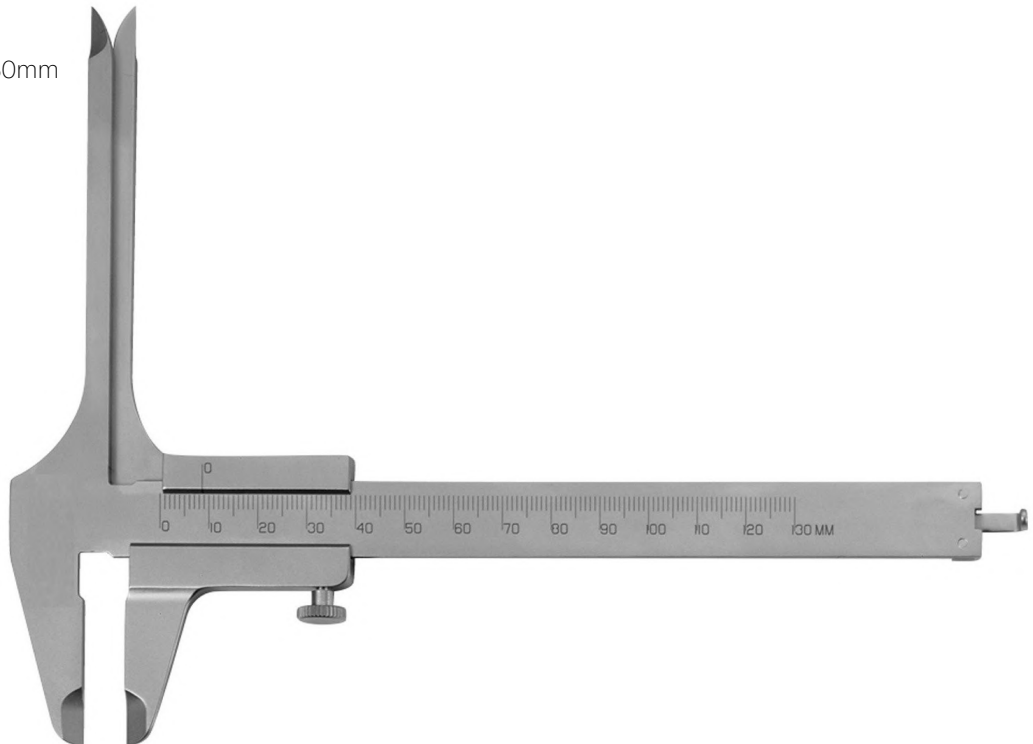

# MEASURING INSTRUMENTS



## Jameson

- Caliper, 0-100mm
- 100mm/4"

14-795-04



---

## Townley

- Caliper, 0-80mm

14-795-10



---

## Thorpe

- Caliper, 0-80mm

14-795-12

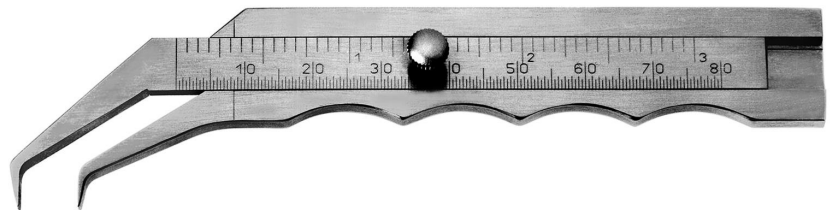



# PODIATRY

## Nail Nipper

- Barrel Spring, Screw Lock
- Concave edge

| Code | Length |
|------|--------|
|------|--------|

|           |          |
|-----------|----------|
| 14-802-12 | 12cm/4¾" |
| 14-802-14 | 14cm/5½" |



## Nail Nipper

- Double Spring,
- Concave edge
- 14cm/5½" length

14-803-14

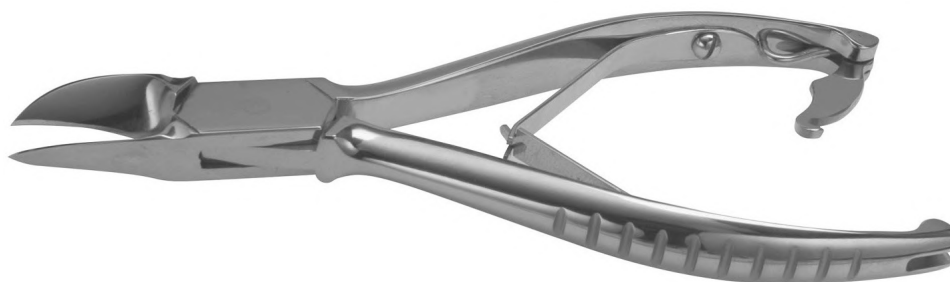

## Cutical Nipper

- Double Spring,
- Convex edge

| Code | Length |
|------|--------|
|------|--------|

|           |          |
|-----------|----------|
| 14-804-14 | 14cm/5½" |
| 14-804-15 | 15cm/6"  |



## Mycotic Nail Nipper

- Heavy duty jaw
- Double Action
- 15cm/6" length

|           |          |
|-----------|----------|
| 14-806-15 | Straight |
| 14-807-15 | Concave  |



Straight

Concave

## Nail Nipper

- Concave edge

| Code | Length |
|------|--------|
|------|--------|

|           |          |
|-----------|----------|
| 14-810-10 | 10cm/4"  |
| 14-810-13 | 13cm/5"  |
| 14-810-14 | 14cm/5½" |
| 14-810-15 | 15cm/6"  |



## Nail Nipper

- Straight
- 13cm/5" length

14-812-13



## Cuticle Nipper With Scissors Grip

- Straight Jaws
- Ring Handle
- 10cm/4" length

14-814-10



## Radolf

- Nail Extraction Forceps
- 13.5cm/5¼" length

13-988-13



- Nail Extraction Forceps
- Duck Jaw
- 14.5cm/5¾" length

13-989-14



## Radolf

- Nail Extraction Forceps
- 14cm/5½" length

14-818-14



## Finger Ring Saw

- With replaceable circular blade
- 17cm/6¾" length

13-984-17

Only Saw

13-985-01



## Walton

- Finger Ring Saw
- with replaceable circular blade
- 16cm/6¼" length

13-982-16

Only Saw

13-983-01



## Mod. Martin

- Finger Ring Saw
- with replaceable circular blade
- 17cm/6¾" length

13-980-17

Only Saw

13-981-01



## Cuticle Nail Scissors

- Curved

01-260-01



## Piffard

- Lupus Curette

14-820-00



Fig.1

14-820-01



Fig.2

14-820-02



Fig.3

14-820-03

- Finger Nail Drill
- with replaceable circular blade
- 16cm/6¼" length

13-370-10

- Complete Set (13-370-10, 13-371-01, 13-371-02, 13-371-03)

13-371-00



13-371-01



13-371-02



13-371-03

## Keys

- Dermal Punch Set
- 12cm/4¾" length

14-822-00

- Handle Only

14-822-01

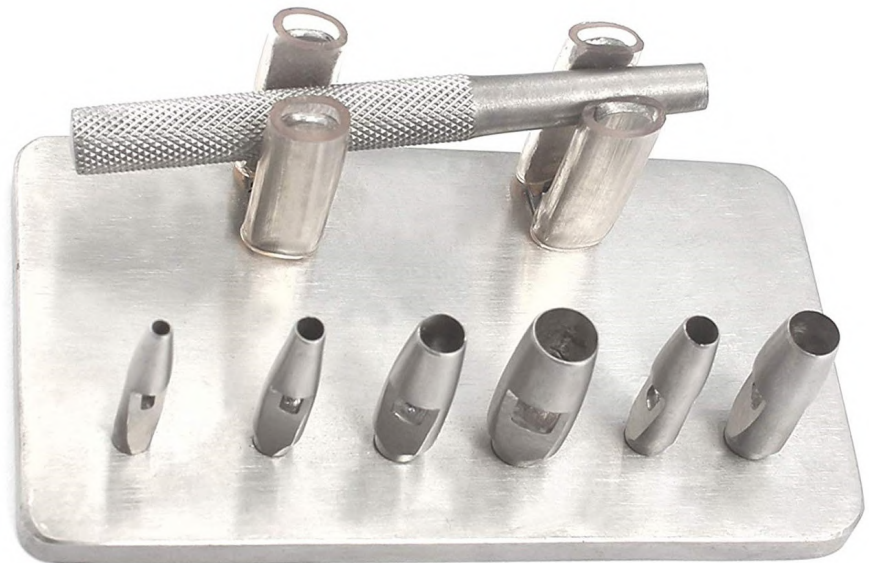

| Head      | Size |
|-----------|------|
| 14-822-02 | 2mm  |
| 14-822-03 | 3mm  |
| 14-822-04 | 4mm  |
| 14-822-05 | 5mm  |
| 14-822-06 | 6mm  |
| 14-822-07 | 7mm  |



## Lead Hand

- Child Size

13-360-01

- AdultSize

13-360-02



---

## Feldheim

- Nail Instrument
- 10cm/4" length

13-366-10





# WIRE INSTRUMENTATION

# PLIERS & WIRE CUTTERS



## Universal Fine Pliers and Cutters

- 15cm/6" length

13-208-15

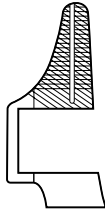

## Slim & Square Ended Wire Pliers

- 

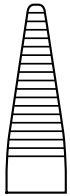

Slim Nose

13-221-03

19cm/7½"



Square Ended

13-221-02

17cm/6¾"



13-221-01

17cm/6¾"



## Pliers for Screw Removal

- 20cm/8" length

13-207-20



## Muller Claus Wire Pullers

- 18cm/7" length
- Double action
- Tungsten jaws

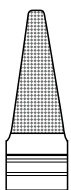

2mm Jaws

13-239-02

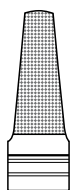

4mm Jaws

13-239-04

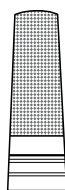

6mm Jaws

13-239-06



# PLIERS & WIRE CUTTERS



## Flat Nose Plier TC

- 18cm/7" length



Fig.1  
13-210-01



Fig.2  
13-210-02

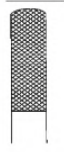

Fig.3  
13-210-03



## Wire Extraction Plier

- 18cm/7" length



Fig.1  
13-212-18



Fig.2  
13-214-18



Fig.3  
13-216-18



## Wire Cutting Forceps

- 15cm/6" length

13-219-01

- For Hard Wire
- Cuts wire up to 1.0mm Ø
- For Soft Wire
- Cuts wire up to 1.5mm Ø



## Waldsach

- Universal Plie
- 16cm/6¼" length

13-219-02



# PLIERS & WIRE CUTTERS



## Wire Cutting Plier



Slim Nose

13-219-03

13cm/5"

Thick Nose

13-219-04

18cm/7"

## Wire Holding Forceps

- 14cm/5½" length

With Serrated Jaws

13-219-05

With One Jaw Smooth

13-219-06



## Hackstocks

- With Longitudinal Groove
- 16cm/6¼" length

13-220-16

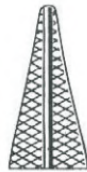

## Angle Wire Cutter

- 13cm/5" length

13-224-01

- For Hard Wire
- Cuts wire up to 0.3mm Ø
- For Soft Wire
- Cuts wire up to 0.5mm Ø

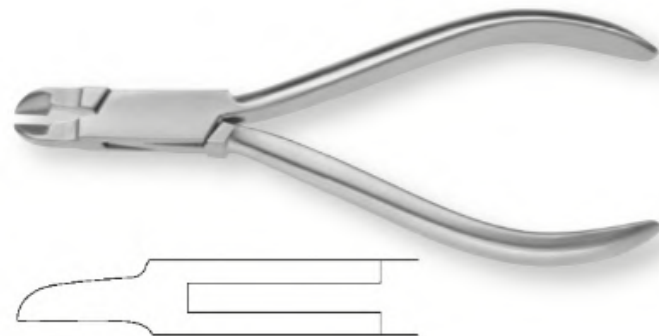

# WIRE HOLDING & EXTRACTION



## Martin

- TC Wire Twisting Forceps
- 14.5cm/5¾" length

13-191-14



## Berry

- TC Heavy Sternal Needle Holder
- 19cm/7½" length



15cm/6"  
13-190-15



15cm/6"  
13-196-15



18cm/6"  
13-190-18



18cm/6"  
13-196-18



20cm/6"  
13-190-20



20cm/6"  
13-196-20

## Berry

- TC Heavy Sternal Needle Holder
- With Drill
- 18cm/7" length

13-196-00



# WIRE HOLDING & EXTRACTION



## Mayo-Hegar

- Standard Needle Holder

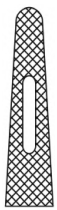

20-390-14

14.5cm/5¾" length

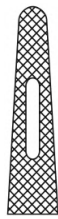

20-390-20

20.5cm/8" length

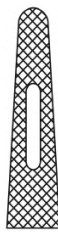

20-390-24

24cm/7" length



20-390-26

26.5cm//9½" length



20-390-30

30.5cm/12" length

## Mayo-Hegar

- TC-Gold Needle Holder



20-642-16

16cm/6¼" length



20-642-18

18.5cm/7¼" length



20-642-20

20cm/8" length



20-642-24

24cm/7" length



20-642-26

26.5cm//9½" length



20-642-30

30cm/11¼" length

# WIRE HOLDING & CUTTERS



## Crowin Needle Holder

- TC Wire Holding Clamp/ Sternum
- 16cm/6¼" length

13-192-16

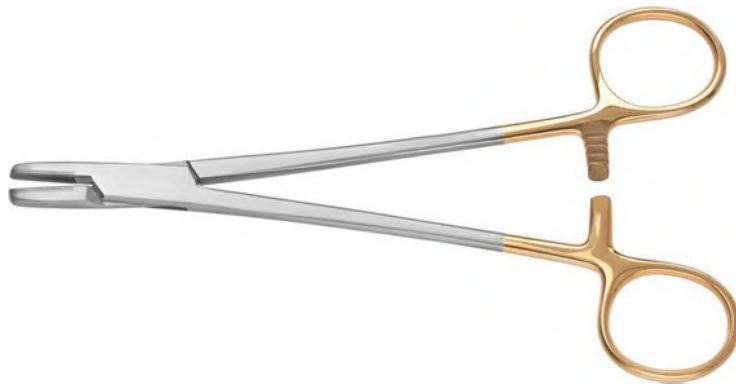

## Crowin

- TC Wire Twister with drill
- 16cm/6¼" length

13-192-17



## TC Wire Cutter

- 12cm/4¾" length

13-224-04

- For Hard Wire
- Cuts wire up to 0.6mm Ø
- For Soft Wire
- Cuts wire up to 1.0mm Ø



## TC Wire Cutter

- 14cm/5½" length

13-224-02

- For Hard Wire
- Cuts wire up to 1.0mm Ø
- For Soft Wire
- Cuts wire up to 1.5mm Ø





# PLIERS & WIRE CUTTERS



## Harvey

- Tungsten carbide edges
- 23.5cm/9" length

13-222-23

- For Hard Wire
- Cuts wire up to 2.2mm Ø
- For Soft Wire
- Cuts wire up to 3mm Ø



## Harvey

- Tungsten carbide edges
- 23.5cm/9" length

13-223-23

- For Hard Wire
- Cuts wire up to 2.2mm Ø
- For Soft Wire
- Cuts wire up to 3mm Ø



## Reil

- Tungsten carbide edges
- 17.5cm/6¾" length

13-235-17

- For Hard Wire
- Cuts wire up to 1.6mm Ø
- For Soft Wire
- Cuts wire up to 2.0mm Ø



- Tungsten carbide edges
- 22cm/8¾" length

13-237-22

- For Hard Wire
- Cuts wire up to 2.2mm Ø
- For Soft Wire
- Cuts wire up to 2.8mm Ø



# PLIERS & WIRE CUTTERS



## Harvey

- Tungsten carbide edges
- 23.5cm/9" length

13-222-23

- For Hard Wire
- Cuts wire up to 2.2mm Ø
- For Soft Wire
- Cuts wire up to 3mm Ø



## Harvey

- Tungsten carbide edges
- 23.5cm/9" length

13-223-23

- For Hard Wire
- Cuts wire up to 2.2mm Ø
- For Soft Wire
- Cuts wire up to 3mm Ø



## Reil

- Tungsten carbide edges
- 17.5cm/6¾" length

13-235-17

- For Hard Wire
- Cuts wire up to 1.6mm Ø
- For Soft Wire
- Cuts wire up to 2.0mm Ø



- Tungsten carbide edges
- 22cm/8¾" length

13-237-22

- For Hard Wire
- Cuts wire up to 2.2mm Ø
- For Soft Wire
- Cuts wire up to 2.8mm Ø



# PLIERS & WIRE CUTTERS



- Tungsten carbide edges
- 18cm/7" length

13-237-18

- For Hard Wire
- Cuts wire up to 1.7mm Ø
- For Soft Wire
- Cuts wire up to 2.0mm Ø



- Tungsten carbide edges
- 16cm/6¼" length

13-237-16

- For Hard Wire
- Cuts wire up to 1.7mm Ø
- For Soft Wire
- Cuts wire up to 2.0mm Ø



## Wire Cutters with T/C Jaws

- 23cm/9" length
- Double action
- Cuts plates & wires up to 3.2mm Ø

13-990-23



# PLIERS & WIRE CUTTERS



- Wire Cutter
- 18.5cm/7¼" length

13-224-03

- For Hard Wire
- Cuts wire up to 1.7mm Ø
- For Soft Wire
- Cuts wire up to 2.0mm Ø



- Tungsten Wire Cutter
- 18.5cm/7¼" length

13-225-03

- For Hard Wire
- Cuts wire up to 1.7mm Ø
- For Soft Wire
- Cuts wire up to 2.0mm Ø



## Head Cutters

- 16cm/6¼" length
- Annulated

13-230-16

- For Hard Wire
- Cuts wire up to 1.8mm Ø
- For Soft Wire
- Cuts wire up to 2.4mm Ø



- Tungsten Wire Cutter
- 14.5cm/5¾" length

13-233-14

- For Hard Wire
- Cuts wire up to 1.0mm Ø
- For Soft Wire
- Cuts wire up to 1.5mm Ø



# PLIERS & WIRE CUTTERS



## Martin-Diamant

- Wire Cutter, Front Action
- 16cm/6¼" length

13-232-16

- For Hard Wire
- Cuts wire up to 2.0mm Ø
- For Soft Wire
- Cuts wire up to 2.2mm Ø



- TC Easy Cut Wire Cutter
- 20cm/8" length

14-832-20

- For Hard Wire
- Cuts wire up to 2.2mm Ø
- For Soft Wire
- Cuts wire up to 2.8mm Ø



- TC Wire Cutter, Front and Side
- Exchangeable TC Blades
- Cuts wire up to 1.6mm Ø
- With integrated rubber jaws
- 18cm/7" length

14-833-18



- TC Wire Cutter, for right hander
- Exchangeable TC Blades
- And Rubber Jaws
- Cuts wire up to 2.2mm Ø
- 18cm/7" length

14-834-18



# PLIERS & WIRE CUTTERS



## TC Pin Cutter For K-Wires

- Up to 5mm
- 46cm/18<sup>3</sup>/<sub>4</sub>" length

13-998-46

- 54cm/21<sup>1</sup>/<sub>4</sub>" length

13-998-54

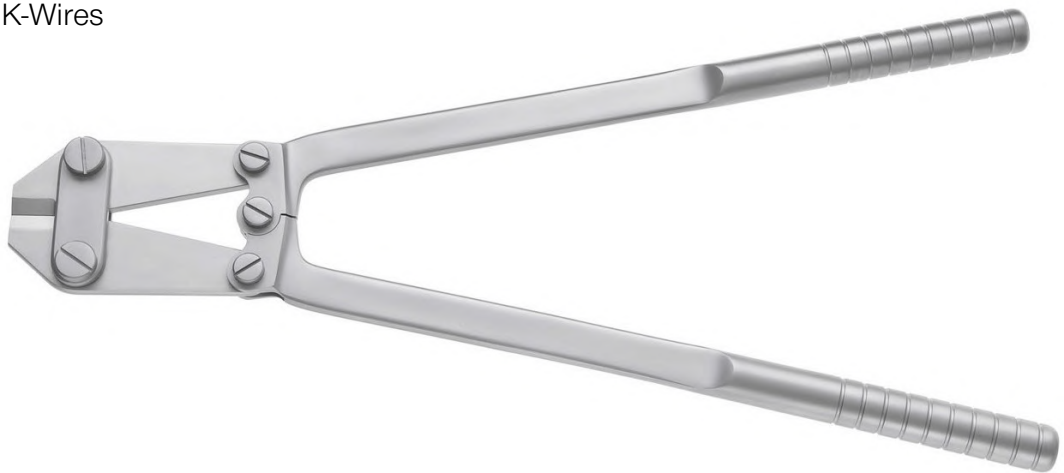

## TC Front Cutter

- 40cm/15<sup>3</sup>/<sub>4</sub>" length
- For wires upto 4.7mm

13-996-40

- 25cm/10" length
- For wires upto 3.2mm

13-994-25



## Pin Cutter for 6.35mm Steinmann pins

- With detachable handle
- 57.5cm/22<sup>1</sup>/<sub>2</sub>" length

14-837-57



# PLIERS & WIRE CUTTERS



## Pin Cutter Titanium

- Titanium Handles
- Hardened Cutting Edges
- 54cm/21¼" length

14-838-54



## TC Pin Cutter



| Code | Length | For wires |
|------|--------|-----------|
|------|--------|-----------|

|           |          |         |
|-----------|----------|---------|
| 13-999-38 | 38cm/15" | Ø 5.0mm |
|-----------|----------|---------|

|           |           |         |
|-----------|-----------|---------|
| 13-999-45 | 45cm/17¾" | Ø 6.0mm |
|-----------|-----------|---------|

|           |          |         |
|-----------|----------|---------|
| 13-999-56 | 56cm/22" | Ø 7.5mm |
|-----------|----------|---------|

## Wire Cutter K-Wire Up to 3mm

- 32cm/12¾" length

13-228-32



## Harms

- TC Vertibral Cutting Forcpes
- 18cm/7" length

14-839-18

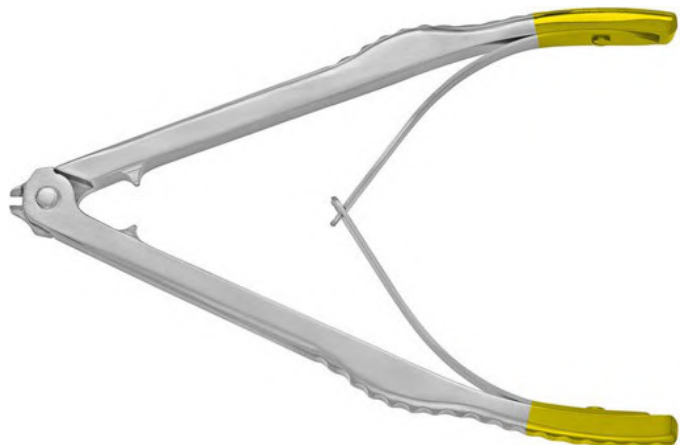

# SCISSORS



## Crown and Collar Scissors

• 10cm/4" length

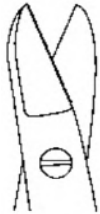
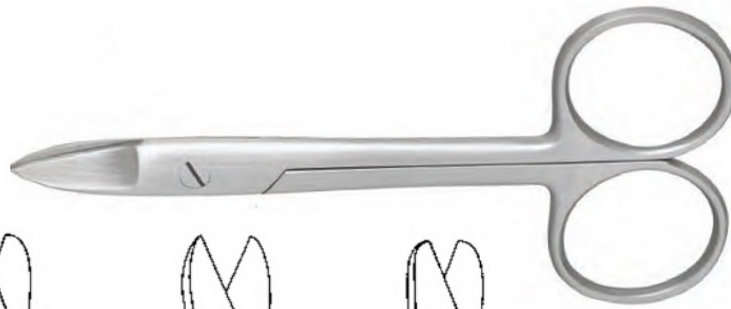

Straight, Sharp  
Serrated

14-840-01

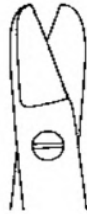

Straight, Blunt  
Serrated

14-840-02



Straight, Sharp

14-840-03



Straight, Blunt

14-840-04



Curved, Sharp  
Serrated

14-842-01



Curved, Blunt  
Serrated

14-842-02



Curved, Sharp

14-842-03



Curved, Blunt

14-842-04

## Crown and Collar Scissors

• 12cm/5" length



Straight, Sharp  
Serrated

14-841-01



Straight, Blunt  
Serrated

14-841-02

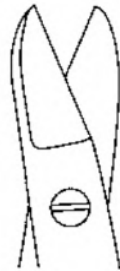

Straight, Sharp

14-841-03

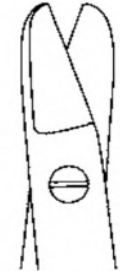

Straight, Blunt

14-841-04



Curved, Sharp  
Serrated

14-843-01



Curved, Blunt  
Serrated

14-843-02



Curved, Sharp

14-843-03



Curved, Blunt

14-843-04



# SCISSORS



## TC Wire Scissors

- Wire Cutter, Front Action
- 12cm/4¾" length

14-844-12

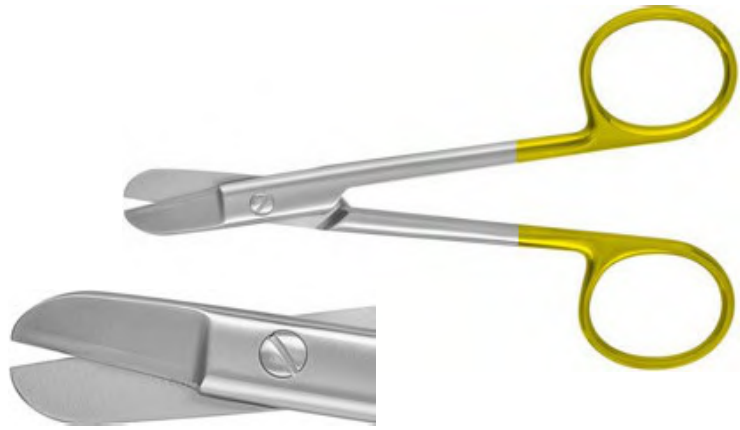

## Smith

- TC Wire Cutting Scissors
- Serrated
- 16cm/6¼" length

14-845-01

Straight

14-845-02

Concave



## Schuknecht

- Wire Scissors, Straight
- Short Blades
- 10cm/4" length

14-846-10

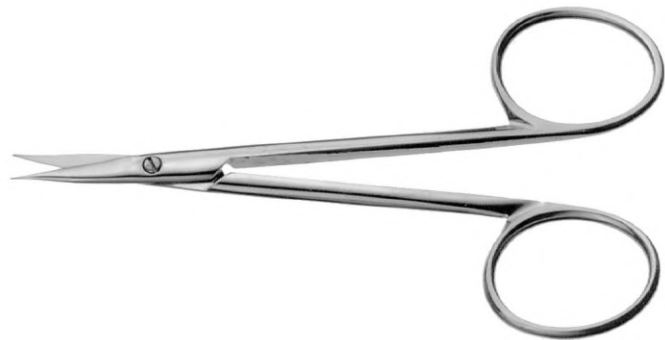

- TC Wire Twister and Scissors
- 18cm/7" length

13-194-18

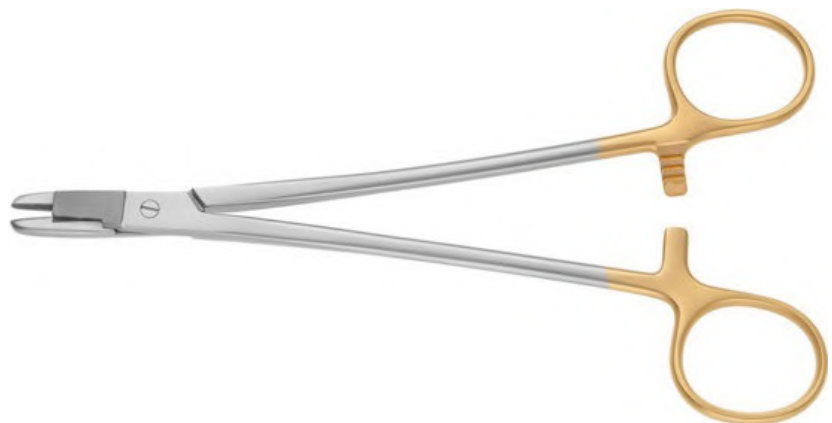

# WIRE CUTTERS & PLIERS



## Baumgartner

- Wire Twisting Forceps, TC
- 20cm/8" length

13-202-20



## Universal

- TC Wire and Plate Shear
- 17cm/6¾" length

14-848-17

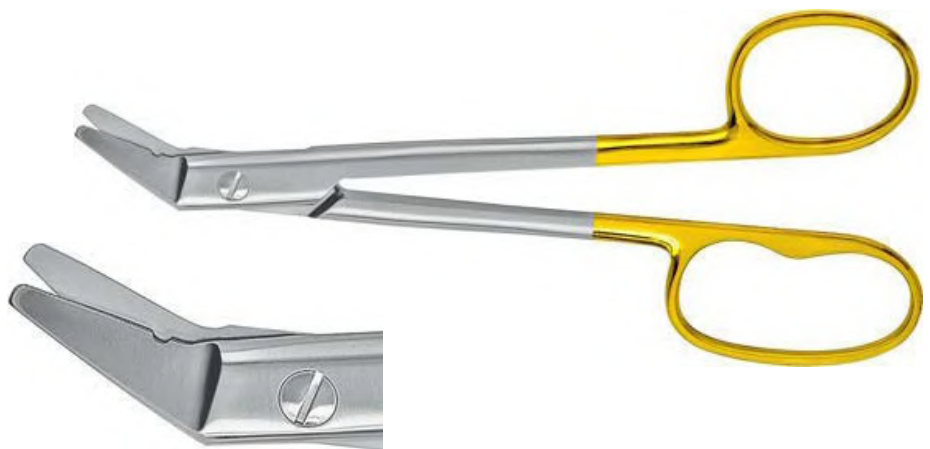

- TC Universal Wire & Plate Scissors
- 12cm/4¾" length

14-849-12

- For Hard Wire
- Cuts wire up to 0.8mm Ø
- For Soft Wire
- Cuts wire up to 1.2mm Ø



## Flat Nose Plier

- with 3.5mm jaw
- 16cm/6¼" length

13-219-07



# LOCKING PLIERS



## Needle Nosed Locking Pliers



| Code      | Length    |        |
|-----------|-----------|--------|
| 14-852-22 | 22cm/8¾"  | Small  |
| 14-852-25 | 25cm/9¾"  | Medium |
| 14-852-30 | 30cm/11¾" | Large  |

## Pliers **modified** for Slap Hammer

| Code      | Length    |        |
|-----------|-----------|--------|
| 14-853-22 | 22cm/8¾"  | Small  |
| 14-853-25 | 25cm/9¾"  | Medium |
| 14-853-30 | 30cm/11¾" | Large  |

## Slap Hammer attachment only

| Code      | Length    | Weight |
|-----------|-----------|--------|
| 14-852-00 | 35cm/13¾" | 400g*  |
| 14-853-00 | 40cm/15¾" | 700g+  |

\* Fits pliers - small & medium size

+Fits pliers - large size

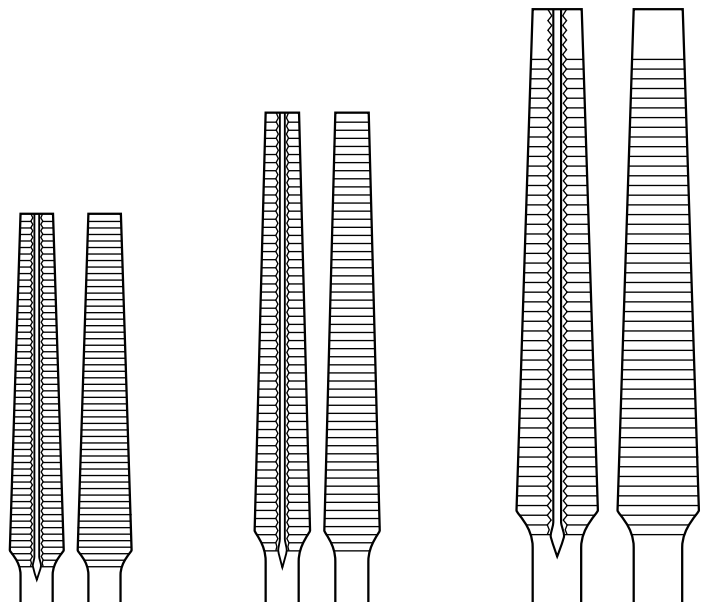

22cm/8¾" Small

25cm/9¾" Medium

30cm/11¾" Large



# LOCKING PLIERS



## Orthopaedic Locking Pliers

- Hardened jaws

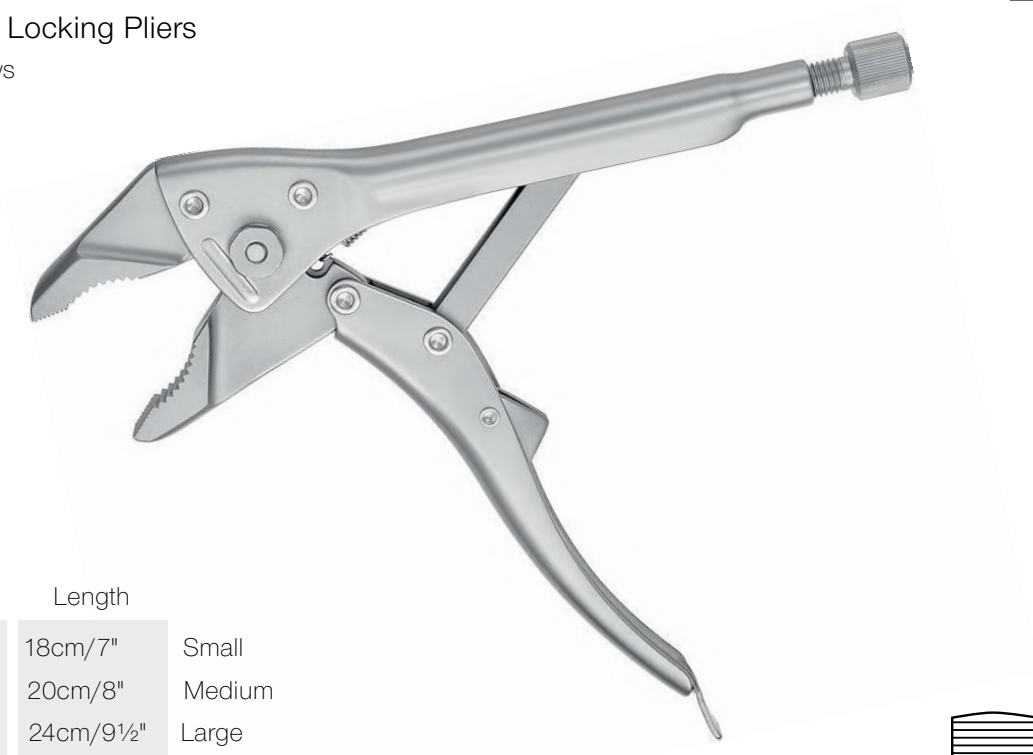

| Code      | Length   |        |
|-----------|----------|--------|
| 13-205-18 | 18cm/7"  | Small  |
| 13-205-20 | 20cm/8"  | Medium |
| 13-205-24 | 24cm/9½" | Large  |

## Orthopaedic Locking Pliers **modified** for Slap Hammer

| Code      | Length   |        |
|-----------|----------|--------|
| 14-205-18 | 18cm/7"  | Small  |
| 14-205-20 | 20cm/8"  | Medium |
| 14-205-24 | 24cm/9½" | Large  |

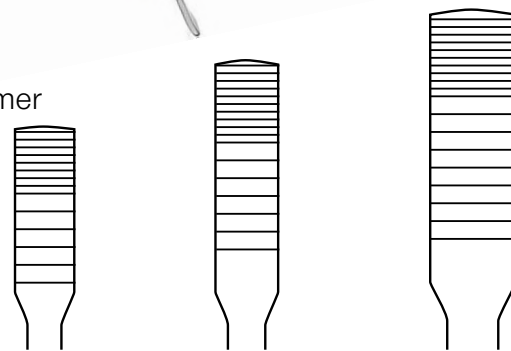

18cm/7" Small      20cm/8" Medium      24cm/9½" Large

**N.B.** When used with slap hammer the locking pliers need modification.

## Combined Wire Cutters & Pliers

- 18cm/7" length
- Suitable for wires up to 1.6mm Ø
- Parallel closing jaws

13-204-18



## Wire Gripper

- Parallel Closure
- 17cm/6¾" length

13-203-17



---

## Bending Plier, Alpha Plaet

- 8" For Plates up to 1.6mm
- 16cm/6¼" length

33-970-16

- 9¾" For Plates up to 3.0mm
- 25.5cm/10" length

33-972-25



---

## Bending Press

- For plates upto 4.5mm
- 40cm/16" length

33-400-00



# WIRE BENDING

## K-wire Applicator

- For K wire  $\varnothing$  0.8-1.6mm

14-855-10



## Mini plate bending forceps

- For 1.5 and 2.0mm plates
- 12.5cm/4¾" length

14-856-12



## K-wire and plate bending forceps

- For mini plates upto 1.6mm
- 90° bending for k-wires
- 14cm/4¾" length

14-857-12



## Steinmann

- Pin extractor for nails
- 14cm/5½" length
- upto 3.2mm

14-858-14

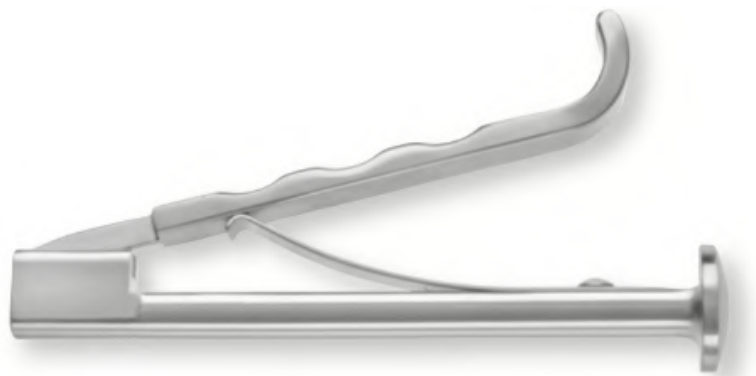

- Wire and Pin bender
- 15cm/6" length
- upto 3.2mm

14-859-15



# WIRE GUIDE



## Wire Guide Instrument

- with ferrozell handle
- 21cm/8¼" length

Ø 45mm

13-248-45

Ø 70mm

13-248-70



## Demel

- Bone Wire Guide

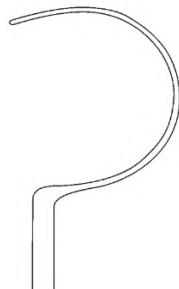

Fig.1

13-240-01

28cm/11" length

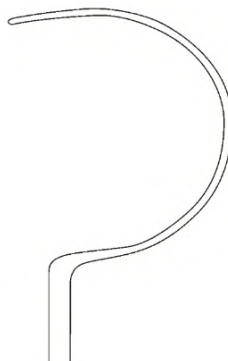

Fig.2

13-240-02

29cm/11½" length

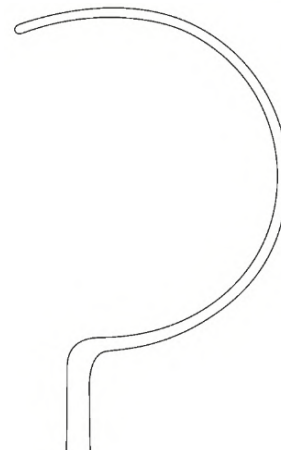

Fig.3

13-240-03

31cm/12½" length

## Kronecker

- Ligature Needle, Right Angled
- 15cm/6" length

13-241-01



## Kronecker

- Ligature Needle, Left Angled
- 15cm/6" length

13-241-02



## Weinraub

- Lamina Spreader
- with drill guide and ratchet
- 18cm/7" length

14-916-18



## Bone Holding Forceps

- with guide for K-wire 1.8mm
- 15cm/6" length

14-917-15



## Lepine

- Rod Bender, Adjustable
- For rods upto 7.0mm diameter
- 28.5cm/11" length

14-918-28

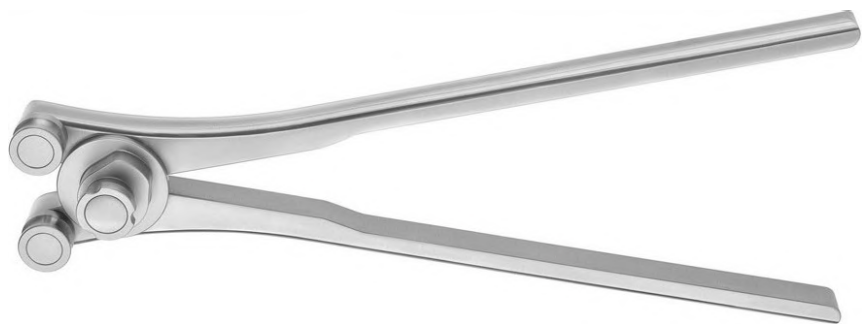

## Bar Bending Plier

- For bar/wire Ø 3-4mm
- 16cm/6¼" length

14-918-16

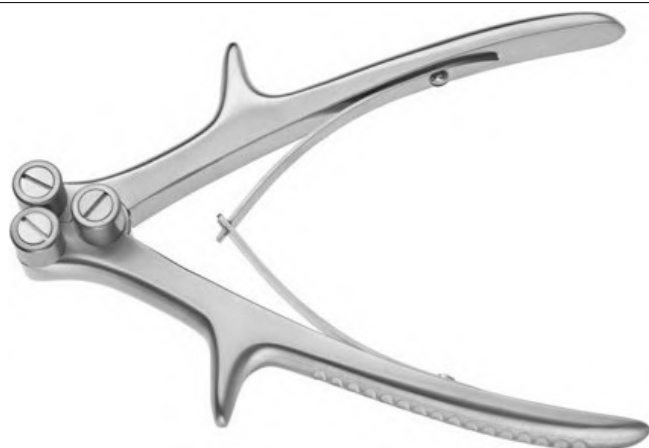



# WIRE TIGHTENING



## Demel

- Wire Tightening and Twisting Forceps
- 28cm/11" length

13-244-28

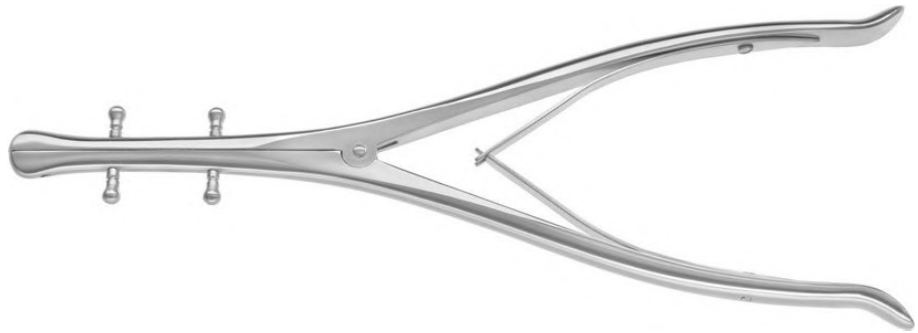

## Wire Tightner

- With Double Wing Nut
- 25cm/10" length

33-870-02



33-870-01

## Loute

- Bone Wire Tightner
- 21cm/8¼" length

13-242-21



- Wire Tightening Forceps
- With interchangeable head
- 26cm/10¼" length

14-921-26



# WIRE EXTENSION



## Kirschner

- With Three Traction Hooks
- 1.5mm Ø wires

Small Pattern/0-40mm

**13-261-01**

18.5cm/7¼" length

Large Pattern/35-200mm

**13-261-02**

27cm/11" length



## Bohler

- Extension Bow

| Code | hxb (cm) |
|------|----------|
|------|----------|

|           |      |
|-----------|------|
| 13-255-16 | 16x9 |
|-----------|------|

For Arm

|           |       |
|-----------|-------|
| 13-255-21 | 21x11 |
|-----------|-------|

For Thigh & Knee

|           |       |
|-----------|-------|
| 13-255-15 | 21x15 |
|-----------|-------|

For Femur & Knee

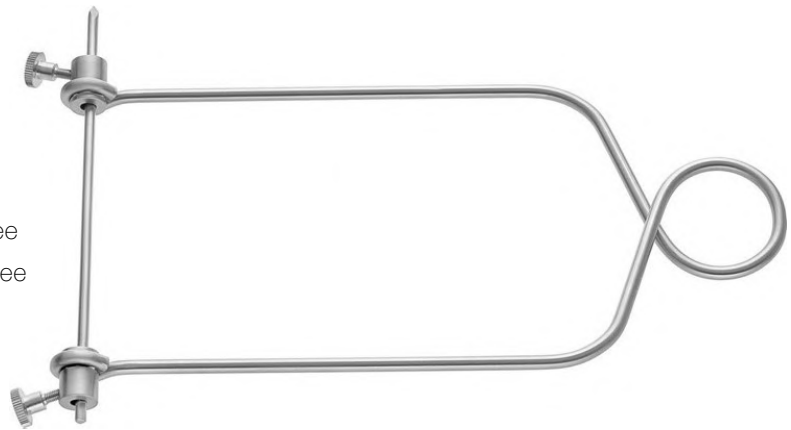

## Steinmann

- Trocar tip
- 4mm Ø

Single Ended

|           |       |
|-----------|-------|
| 13-250-14 | 140mm |
|-----------|-------|

|           |       |
|-----------|-------|
| 13-250-16 | 160mm |
|-----------|-------|

|           |       |
|-----------|-------|
| 13-250-18 | 180mm |
|-----------|-------|

|           |       |
|-----------|-------|
| 13-250-20 | 200mm |
|-----------|-------|

Double Ended

|           |       |
|-----------|-------|
| 13-252-16 | Fig.1 |
|-----------|-------|

|           |       |
|-----------|-------|
| 13-252-19 | Fig.2 |
|-----------|-------|

|           |       |
|-----------|-------|
| 13-252-22 | Fig.3 |
|-----------|-------|

Single Ended

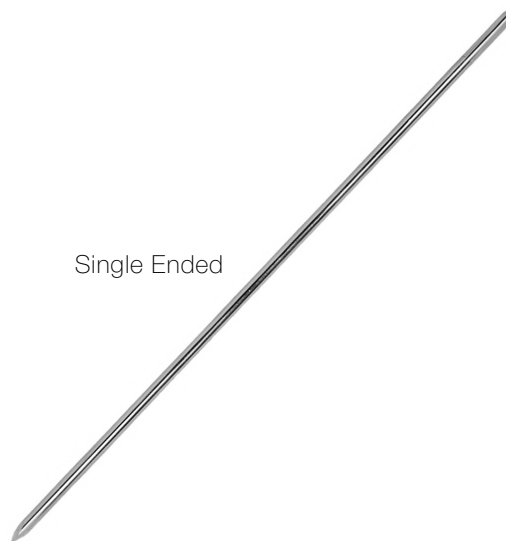

# WIRE EXTENSION



## Kirschner

- Extension Bow
- Complete with three traction hooks

13-263-18  
18x10cm

13-263-27  
27x16cm



## Kirschner

- Extension Bow For Knee
- Complete with three traction hooks

Code            cm

|           |           |
|-----------|-----------|
| 13-265-01 | 9.5x7.0   |
| 13-265-02 | 10.5x10.5 |
| 13-265-03 | 12.0x12.0 |
| 13-265-04 | 15.5x15.5 |
| 13-265-05 | 20.0x15.5 |
| 13-266-01 | 6.0x5.0   |
| 13-266-02 | 9.5x11.0  |
| 13-266-03 | 13.5x13.0 |



13-267-03  
Small



13-267-06  
Large



# DRILLS SAWS AND AWLS

# REAMERS



## Perthes

- Reamer, Square
- 21cm/8¼" length

13-124-21



- Reamer, Square
- 18cm/7" length

13-122-18

## Awl With T-Handle

- 14cm/5½" length

13-126-14

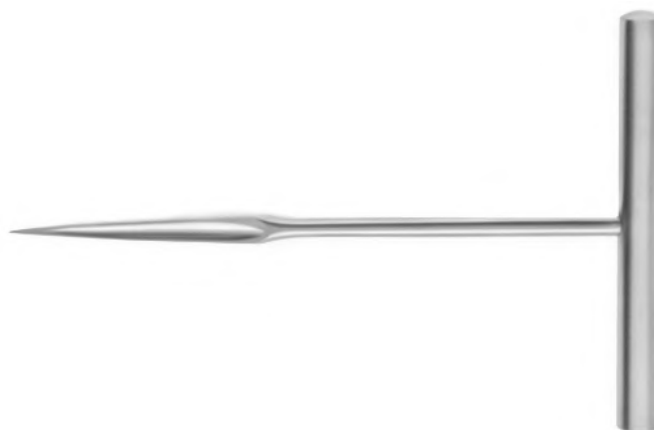

## Reamer, Ø 2.5-3.5mm

- 14cm/5½" length

13-120-14



## Adson

- Bone Drill, Reamer
- 15cm/6" length

13-129-15



# AWLS

## Obwegesar, Awl

- Reamer, Square
- 23cm/9" length

14-928-23



---

## Obwegesar, Awl

- 18cm/7" length

14-929-18



---

## Brunner

- Awl, Malleable
- 23cm/9" length

14-930-23



---

## Brunner

- Awl, Curved
- 30cm/11¾" length

14-931-30



# HAND DRILLS



## Stille

- Complete, With Burrs
- 20cm/8" length



### Twills Drills

|           |         |
|-----------|---------|
| 13-186-01 | Ø 2.5mm |
| 13-186-02 | Ø 3.0mm |
| 13-186-03 | Ø 3.5mm |
| 13-186-04 | Ø 4.0mm |
| 13-186-10 | Ø 1.0mm |
| 13-186-11 | Ø 1.5mm |
| 13-186-12 | Ø 2.0mm |



### Round Burs

|           |          |
|-----------|----------|
| 13-186-07 | Ø 8.0mm  |
| 13-186-08 | Ø 12.0mm |
| 13-186-09 | Ø 16.0mm |



Ø 5.0mm  
13-186-06



Ø 10.0mm  
13-186-05

## Stille, Shermann

- 24cm/9½" length

13-184-24



### Round Burs

|           |         |
|-----------|---------|
| 13-184-01 | Ø 2.5mm |
| 13-184-02 | Ø 3.0mm |
| 13-184-03 | Ø 3.5mm |



## Moore

- Complete with 3 drills
- 2 twist drills 13-185-01
- 1 twist drill 13-185-02

13-185-24



### Round Burs

|           |         |             |
|-----------|---------|-------------|
| 13-185-01 | Ø 3.2mm | 70mm length |
| 13-185-02 | Ø 3.2mm | 90mm length |



# HAND DRILLS

## Bunnel

- Hand drill with adjustable handle
- with jacobs chuck

13-188-01



## Bunnel

- Max shank Ø: 4.0mm
- 16cm/6¼" length

13-182-10

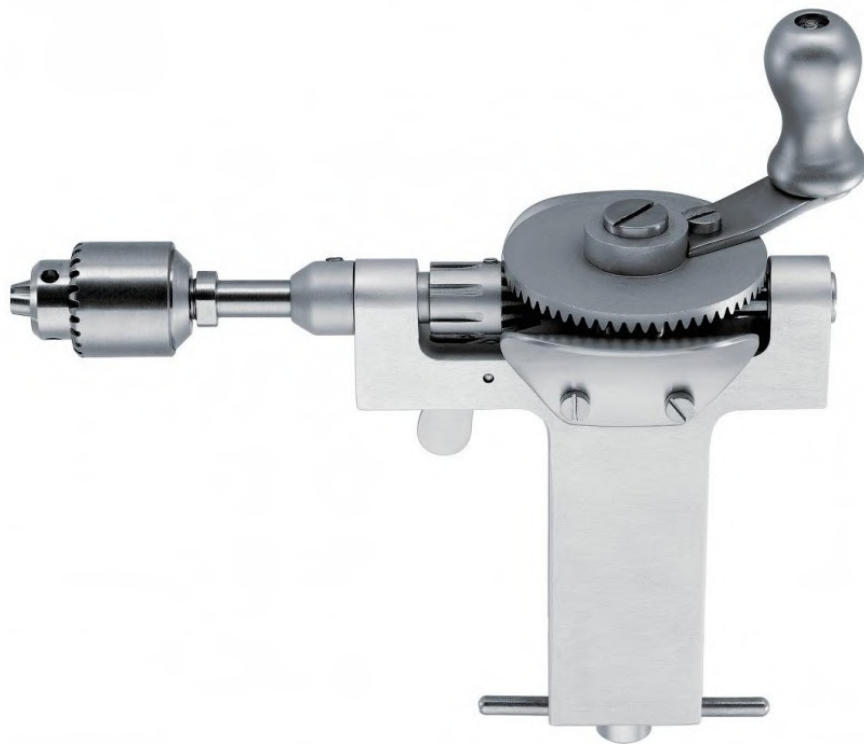



# HAND DRILLS



## Ralk

- Hand drill with jacobs-chuk and key
- Ø 0-4mm

13-182-00



## Ralk

- Hand drill, Large with jacobs-chuk and key
- Ø 0-4mm

13-182-01



## Smedberg Hand Drill

- Complete with Three-jaw chuck

13-182-02

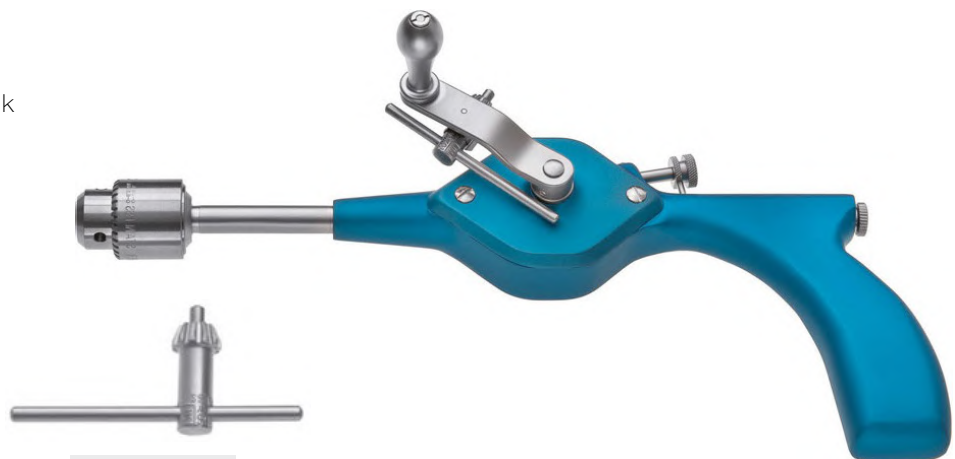

13-182-03

# HAND DRILLS



## T-Handle Drill

- Stell chuck ind. key

HA5015-12



## T-Handle with jacobs-chuck

- 12cm/4¾" length
- 0.5mm - 4mm cannulated
- Ø 5.2mm ind. key

13-188-02



## T-Handle with universal-chuck

- 14cm/5½" length
- 1.0mm-6mm cannulated
- Ø 5.2mm

SP5507-14



## T-Handle with Universal-chuck

- 13cm/5" length
- 1.0mm-6mm cannulated
- Ø 6.1mm
- With reverse lock, ind. key

SP5507-14



## T-Handle with Roehm-chuck

- 13cm/5" length
- 0.5mm-7mm cannulated
- Ø 6.1mm, ind. key

SP5507-14



# HAND DRILLS



## Hudson

- Complete Set

13-181-00

- Brace, Extension

13-181-01

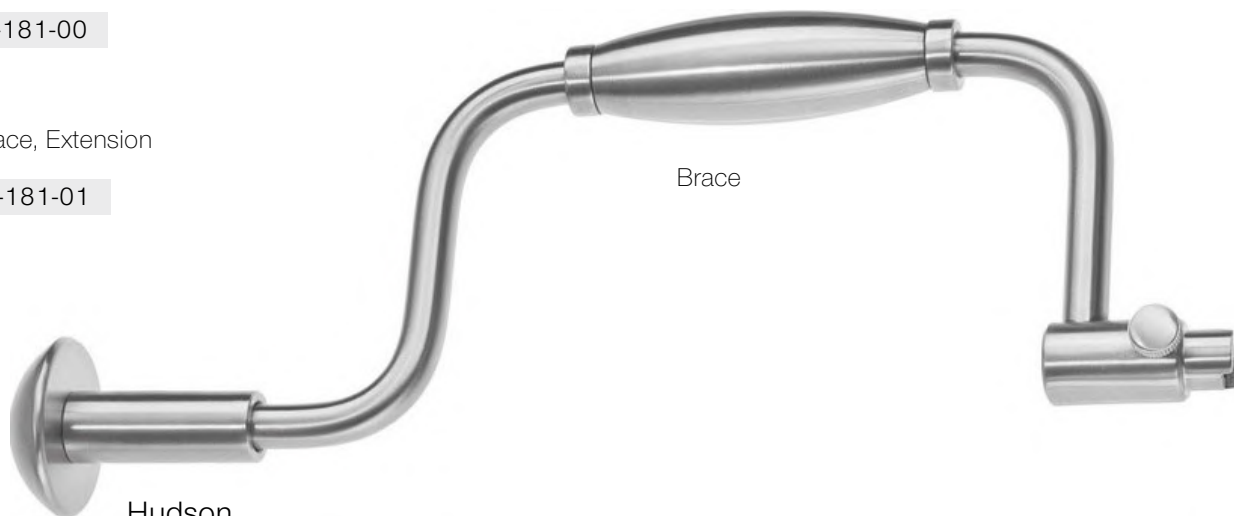

## Hudson

- 27cm/10<sup>3</sup>/<sub>4</sub>" length

13-180-27



Ø 9mm

13-180-01



Ø 14mm

13-180-05



Ø 9mm

13-180-02



Ø 2mm

13-180-06



Ø 16mm

13-180-03



Ø 15mm

13-180-10



Ø 22mm

13-180-04



Ø 13mm

13-180-07



Extension Piece

13-180-09



Ø 16mm

13-180-08



## Hudson Tightening Screw

Hand drill only, with tightening screw

13-180-15



## Hudson Snap Lock

Hand drill only, with nap lock

13-180-16

# DRILLS



## T-Handle Drill

- Stell chuck ind. key

HA5015-12

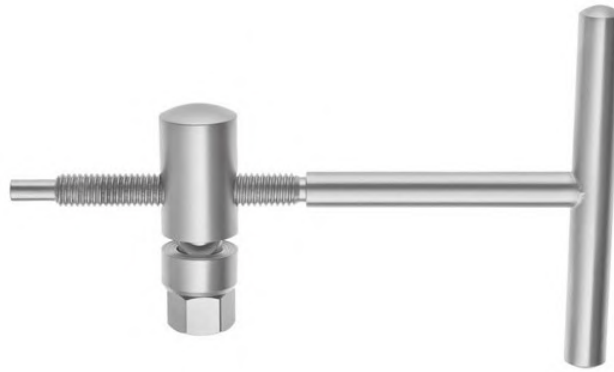

## Key

- 11mm

33-816-11



## Key

- 14cm/5½" length

33-817-01

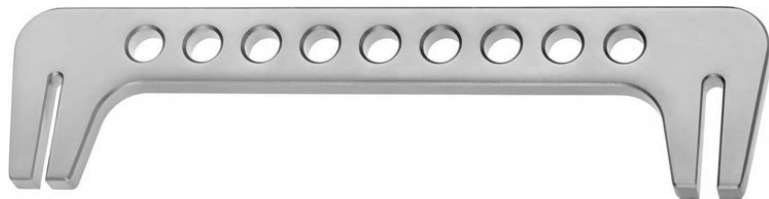

## Bending Iron

- 14.5cm/6" length

use for 3.5 & 2.7mm plates

33-394-01

use for 2.7 & 3.5mm plates

33-394-02



## Key

13cm/5" length

33-818-04



## Michele

- Terphine
- 18cm/7" length

33-830-18    Ø inside: 3mm  
                  Ø outside: 5mm

33-831-18    Ø inside: 5mm  
                  Ø outside: 6mm

33-832-18    Ø inside: 6.5mm  
                  Ø outside: 8mm



# TWIST DRILLS



## Round Fitting Twist Drill

- Stainless steel

| Code      | Diameter | Length | Flute |
|-----------|----------|--------|-------|
| 33-149-11 | 1.1mm Ø  | 60mm   | 35mm  |
| 33-149-15 | 1.5mm Ø  | 85mm   | 60mm  |
| 33-149-20 | 2.0mm Ø  | 100mm  | 75mm  |
| 33-149-25 | 2.5mm Ø  | 110mm  | 85mm  |
| 33-149-27 | 2.7mm Ø  | 100mm  | 75mm  |
| 33-149-32 | 3.2mm Ø  | 145mm  | 120mm |
| 33-149-35 | 3.5mm Ø  | 110mm  | 85mm  |
| 33-149-45 | 4.5mm Ø  | 145mm  | 120mm |
| 33-149-60 | 6.0mm Ø  | 195mm  | 170mm |

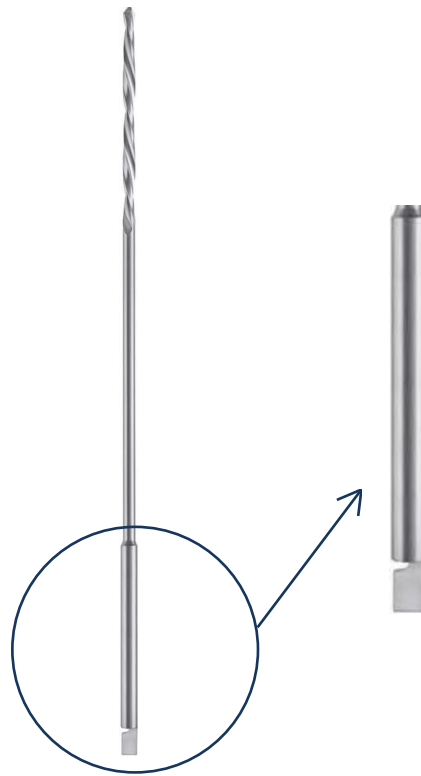

## AO Fitting Twist Drill

- Stainless steel

| Code      | Diameter | Length | Flute |
|-----------|----------|--------|-------|
| 33-150-11 | 1.1mm Ø  | 60mm   | 35mm  |
| 33-150-15 | 1.5mm Ø  | 85mm   | 60mm  |
| 33-150-20 | 2.0mm Ø  | 100mm  | 75mm  |
| 33-150-25 | 2.5mm Ø  | 110mm  | 85mm  |
| 33-150-27 | 2.7mm Ø  | 100mm  | 75mm  |
| 33-150-32 | 3.2mm Ø  | 145mm  | 120mm |
| 33-150-35 | 3.5mm Ø  | 110mm  | 85mm  |
| 33-150-45 | 4.5mm Ø  | 145mm  | 120mm |
| 33-150-60 | 6.0mm Ø  | 195mm  | 170mm |

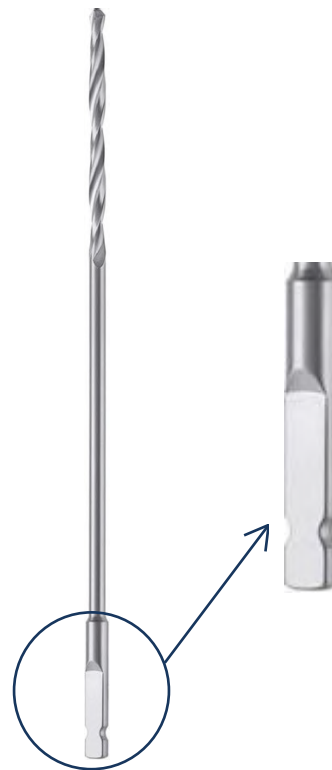

## AO Fitting Twist Tap

- Stainless steel

| Code      | Diameter |
|-----------|----------|
| 33-156-15 | 1.5mm Ø  |
| 33-156-20 | 2.0mm Ø  |
| 33-150-27 | 2.7mm Ø  |
| 33-150-35 | 3.5mm Ø  |
| 33-150-45 | 4.5mm Ø  |
| 33-150-65 | 6.5mm Ø  |



# HIP REVISION INSTRUMENTS



## Femoral Head Extractor

- 23cm/9" length
- Tufnol handle

33-521-23



## Slotted Mallet

33-210-30



## Kuntscher

- Bone Awl
- 26cm/10¼" length

Width

33-180-08

8mm

33-180-10

10mm

33-180-12

12mm



## Kuntscher

- Extraction Hook Handle
- 63cm/24¾" length

33-186-63

- Complete Set

33-186-00



Fig.1  
33-186-01



Fig.2  
33-186-02



## MISCELLANEOUS

## Frazier

- Aspiration Cannula
- 19cm/7½" length



### Code

|           |                |
|-----------|----------------|
| 14-938-06 | 6 Charr/2.0mm  |
| 14-938-08 | 8 Charr/2.5mm  |
| 14-938-10 | 10 Charr/3.0mm |
| 14-938-12 | 12 Charr/4.0mm |

## Ferguson

- Suction Cannula with finger
- Cut-off and stylet
- 18cm/7" length



### Code

|           |                |
|-----------|----------------|
| 14-939-06 | 6 Charr/2.0mm  |
| 14-939-08 | 8 Charr/2.5mm  |
| 14-939-10 | 10 Charr/3.0mm |
| 14-939-12 | 12 Charr/4.0mm |

## Baron

- Suction Cannula with finger
- Cut-off and stylet



75mm, 3" working length

|           |               |
|-----------|---------------|
| 14-940-03 | 3 Charr/1.0mm |
| 14-940-05 | 5 Charr/1.8mm |
| 14-940-07 | 7 Charr/2.3mm |

100mm, 4" working length

|           |               |
|-----------|---------------|
| 14-941-03 | 3 Charr/1.0mm |
| 14-941-05 | 5 Charr/1.8mm |
| 14-941-07 | 7 Charr/2.3mm |

## yankauer

- Suction tube with central drill
- with olive, Ø 7.9mm
- 27cm/10¾" length

- Complete Instrument

14-942-27



- Olive only, Ø 7.9mm

14-942-00



# SCREWDRIVERS



## Slotted Head

- 17cm/6¾" length
- For head screws 2.7mm - 4.0mm

33-286-17



## Long Slotted Head

- 25cm/10" length
- For head screws 2.7mm - 4.0mm

33-286-25



## Phillips Head

- 25cm/10" length
- For small Phillips head screws 6mm

33-292-25



## Cross Slotted Head

- 25cm/10" length
- For cross slot screws 6mm

33-290-25



# SCREWDRIVERS



## Hexagonal Head

- 25cm/10" length
- For hexagonal head screws 2.7mm - 4.0mm



## Hexagonal Screwdriver

- 5mm

33-550-50



## Screwdriver Handle Small

- To fit shafts with quick lock attachment

33-110-00



## Shaft with Quick Lock Fitting

- Hexagonal tip

| Shaft     | Diameter |
|-----------|----------|
| 33-130-15 | 1.5mm    |
| 33-130-25 | 2.5mm    |
| 33-130-35 | 3.5mm    |



# SCREWDRIVERS



## Tap T-Handle

- 25cm/10" length

Shaft

|           |       |
|-----------|-------|
| 33-520-35 | 3.5mm |
| 33-520-45 | 4.5mm |
| 33-520-70 | 7.0mm |



## Cannulated Counter Sink

Shaft

|           |       |                               |
|-----------|-------|-------------------------------|
| 33-620-11 | 1.1mm | For mini screws 1.5/2 mm      |
| 33-620-20 | 2.0mm | For small screws 2.7/3.5/4 mm |
| 33-620-32 | 3.2mm | For malleolar screws 4.5 mm   |



## Cannulated Counter Sink

- with T-Handle
- 4.5mm
- For large screws 4.5/6.5mm

33-624-45



## Parallel Wire Guide

- For guide Ø 2.0mm

33-600-02



## Tissue Protector Sleeve

- For cannulated screw Ø 7.0mm

33-610-07



## Tap & Drill Sleeve

|           |           |
|-----------|-----------|
| 33-752-27 | 2.7/2.0mm |
| 33-752-35 | 3.5/2.5mm |



## Drill Sleeve

- Double, 3.2/6.5mm

33-784-32

- Double, 4.5/3.2mm

33-780-45



## Neutral drill guides

|           |       |
|-----------|-------|
| 33-840-20 | 2.0mm |
| 33-840-27 | 2.7mm |
| 33-840-35 | 3.5mm |
| 33-840-45 | 4.5mm |



## Triple Drill Guide

- Ø 2.0mm

33-660-20



## Ferris-Smith-Kerrison

- Punch, non detachable
- Cutting upward, 40°
- 18cm/7" length

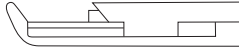

| Code      | Jaw width |
|-----------|-----------|
| 24-978-09 | 2.0mm     |
| 24-978-17 | 3.0mm     |
| 24-978-25 | 4.0mm     |
| 24-978-33 | 5.0mm     |
| 24-978-41 | 6.0mm     |

## Ferris-Smith-Kerrison

- Blackline Rongeur, Straight
- Cutting upward, 40°
- 18cm/7" length

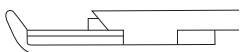

| Code      | Jaw width |
|-----------|-----------|
| 24-979-09 | 2.0mm     |
| 24-979-17 | 3.0mm     |
| 24-979-25 | 4.0mm     |
| 24-979-33 | 5.0mm     |
| 24-979-41 | 6.0mm     |

## Ferris-Smith-Kerrison

- Standard Rongeur, Bayonet
- Cutting upward, 40°
- 18cm/7" length

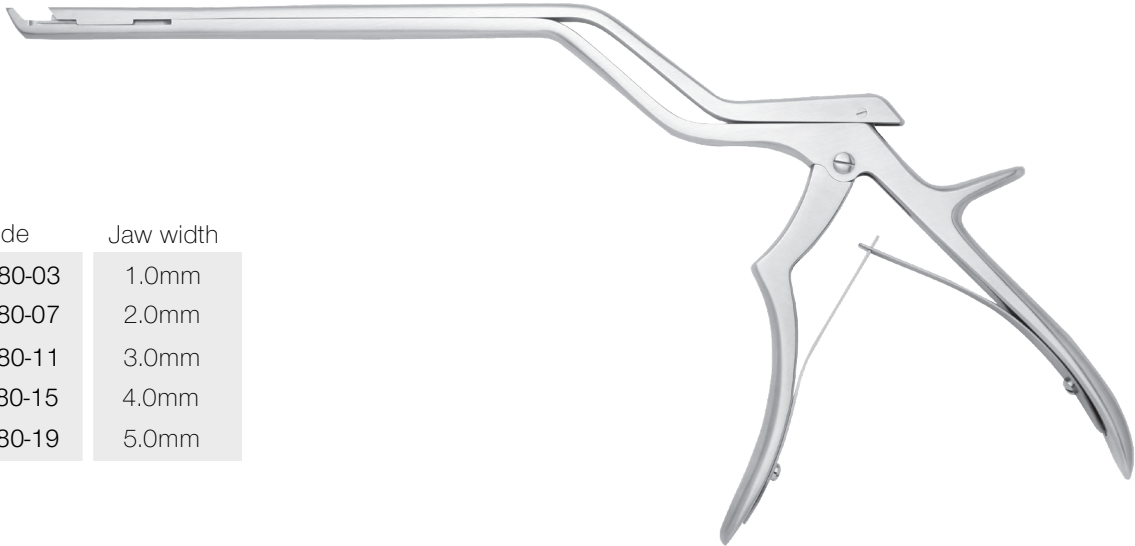
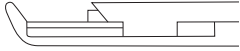

| Code      | Jaw width |
|-----------|-----------|
| 24-980-03 | 1.0mm     |
| 24-980-07 | 2.0mm     |
| 24-980-11 | 3.0mm     |
| 24-980-15 | 4.0mm     |
| 24-980-19 | 5.0mm     |

## Ferris-Smith-Kerrison

- Blackline Rongeur, Bayonet
- Cutting upward, 40°
- 18cm/7" length

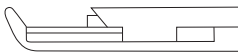

| Code      | Jaw width |
|-----------|-----------|
| 24-980-03 | 1.0mm     |
| 24-980-07 | 2.0mm     |
| 24-980-11 | 3.0mm     |
| 24-980-15 | 4.0mm     |
| 24-980-19 | 5.0mm     |

# SCISSORS



## Metzenbaum

- Standard Scissors
- Curved
- 18cm/7" length

11-285-18



---

## Mayo

- Dissecting Scissors
- Straight
- 14cm/5½" length

11-170-14

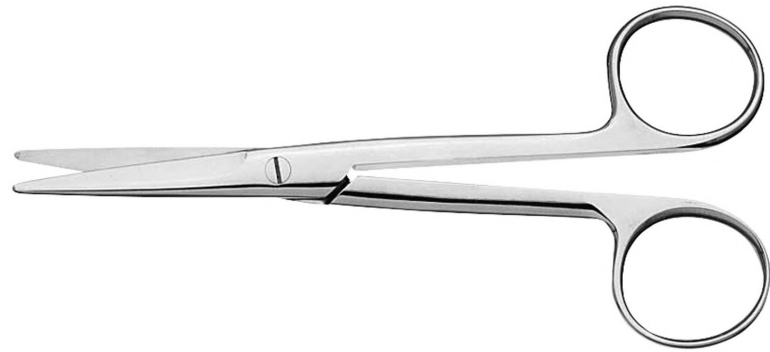

---

## Adventitia

- Micro Scissors, 8mm diameter
- 15cm/6" length
- Straight, 9mm Blade

EM306GN

- Curved, 9mm Blade

EM309GN





Empire

71-75 Shelton Street, Covent Garden London, UK WC2H 9JQ

Tel: +44 2038731071, Email: [sales@empiresurgical.co.uk](mailto:sales@empiresurgical.co.uk)

[www.empiremedical.co.uk](http://www.empiremedical.co.uk)

Award Winner Manufacturer VAT  
Registration No: 285 2450 93

ISO , FDA (cGMP), CE