

# Introduction

Since 1975 we have served the HealthCare Industry with the finest products and saved the lives of people. Empire Surgical has proven itself as a quality manufacturer and exporter of Dental, Surgical & Veterinary instruments

Empire Surgical aims to contribute and help the world of health care, with the most innovative technology in the Health Care Industry. Empire Surgical is aiming to be a solid global company with high class quality with a passion for manufacturing and spirit for meeting a challenge and always looking for new innovations. Our team is always in contact with the leading doctors from the globe to work on universal ideas.

We stand behind every product we offer, listen to our customers and exceed their expectations. We are a rapidly growing company, achieving high Quality standards in a very short period. Empire Surgical is a truly customer centric company and focus on creation of new values.



## CONTENTS

### **DIAGNOSTICS**

EXPLORERS-----	3-5
MIRRORS-----	5-6
HANDLES-----	7-8
PERIODONTAL PROBES AND HOES-----	9-11
TOOTH TWEEZER-----	12-14



**DIAGNOSTIC**

### **RESTORATIVE**

NEW DESIGN HANDLE-----	16
FILLING INSTRUMENTS-----	17-23
BURNISHERS-----	24
EXCAVATORS-----	25-28
COMPOFILL INSTRUMENTS-----	29
HEIDMAN SPETULA-----	30
CARVING INSTRUMENTS-----	32-33
CEMENT SPETULA-----	34,52-53
AMALGAM CARRIER-----	35-37
CROWN REMOVER-----	37-43
STEAMER NET-----	44
WAXING & MODELLING INSTRUMENTS-----	45-50
CERAMIC SCULPTURING INSTRUMENTS-----	51



**RESTORATIVE**

### **ENDODONTIC**

MATRIX RETAINERS-----	55-57
RUBBERDAM INSTRUMENTS-----	58-59
BRACKET TWEEZER-----	60
BRACKET POSITIONER-----	61
LIGATURE POSITIONER-----	62
BAND PUSHER-----	63
ENDODONTIC TWEEZER-----	64-65
EXCAVATORS-----	66
ROOT CANAL INSTRUMENTS-----	67
SOFTLINE /MAXGRIP INSTRUMENTS-----	68
ENDODONTIC BOXES-----	69-70
ENDO BASIC SET-----	71



**ENDODONTICS**

### **PERIODONTICS**

PERIO SURGICAL SET-----	73-74
GRACEY CURETTES -----	75-76
SCALERS/CURETTES-----	77-78,84-86
PERIODONTAL CHIESELS-----	80-81
BONE CURETTES-----	82-83
GINGIVECTOMY KNIVES-----	87
TUNNELING INSTRUMENTS-----	88
PERION FILES-----	89
RASPATORIES-----	90
TITAN CURETTES-----	91



**PERIODONTICS**

## **SURGICAL**

EXTRACTING FORCEPS ENGLISH PATTERN -----	93-104
EXTRACTING FORCEPS AMERICAN PATTERN-----	105-116
EXTRACTING FORCEPS (GOLD PLATED)-----	117-119
ROOT SPLINTER FORCEPS-----	120
ROOT ELEVATORS-----	121-134,134,145-146
ROOT TIP PICKS -----	135
ROOT ELEVATORS (TITANIUM) -----	137-138
LUXATORS -----	139-143
CROSS BAR HANDLE-----	144
RETRACTORS-----	147-157
MALLOTS-----	159-161
RASPATORIES-----	162
RASPATORIES + ELEVATORS-----	163
BONE FILES SHARP SPOONS-----	164
SCALPEL HANDLES-----	165-166
SUCTION TUBES-----	167
DISSECTING FORCEPS -----	168-170
TISSUE FORCEPS-----	171-172
SCISSORS-----	173-176
NEEDLE HOLDERS-----	177-183
SURGICAL BASIC SET-----	184
HAEMOSTATIC FORCEPS -----	185-188
TOWEL CLAMPS -----	188
BONE RONGEURS-----	189-192



## **ANAESTHESIA**

CARTRIDGE SYRINGE -----	194-202
NEEDLE RE-CAPPER-----	203



## **IMPRESSION MATERIAL**

IMPRESSION TRAYS -----	205-209
------------------------	---------



## **IMPLANTOLOGY**

BONE SCRAPER -----	211
SUCTION TUBES -----	212
COMPACTOR -----	213
BONE MILL -----	214
TISSUE PUNCHES -----	215
BONE PLIER S-----	216-217
TITANIUM CURETTES-----	218
MEASURING INSTRUMENTS -----	219-222
IMPLANT HOLDING TWEEZERS-----	223-224
BONE SCRAPER AND BONE SCOOP-----	225
SINUS LIFT CURETTES -----	226-228
BONE SPREADING SYSTEM-----	229
CHIESEL/OSTEOTOMES -----	230-232





SINUS LIFT ELEVATOR-----	233-234
OSTEOTOMES-----	236
BONE MILL-----	237
TREPHINES-----	238-239
PLACEMENT INSTRUMENTS-----	240-241
PERIOTOMES-----	243
LUXATORS-----	244
MICRO INSTRUMENTS-----	245
TITANIUM INSTRUMENTS-----	246
IMPLANT MAINTENANCE SET-----	247

**ORTHODONTICS**

FLAT NOSE PLIERS-----	249
ORTHODONTIC PLIERS -----	250-255,258
ORHTODONTIC CUTTERS-----	256-257

**INSTRUMENT MANAGEMENT**

INSTRUMENT TRAYS -----	260-274
------------------------	---------

**LABORATORY**

MIXING CUP-----	276-277
ARTICULATORS-----	278-284
WAXING INSTRUMENTS -----	285
PLASTER SHEAR-----	286
SAW AND BLADE S-----	287
OTHER LABORATORY INSTRUMENTS-----	288
DENTAL ALLOYS -----	289-290
TUNGSTON CARBIDE BURS -----	291-292

**VETERINARY INSTRUMENTS**

MOUTH GAGS-----	294-295, 301
MIRRORS-----	295
LIP RETRACTOR-----	295
ELEVATORS-----	296-297
EXTRACTION FORCEPS-----	298
SCALERS AND CUTTERS-----	299
PLUGGERS AND SPREADERS-----	300
RETRACTORS-----	301
OTHERS -----	302

**KITS AND SETS**

DENTAL KITS AND SETS-----	306-312
---------------------------	---------

**XRAY AND NOVELETIES**

INTRAORAL PHOTOGRAPHIC MIRROR-----	314-315
KEY CHAINS-----	316
NAPKIN HOLDERS -----	317



**ORTHODONTICS**



**INSTRUMENT MANAGEMENT**



**LABORATORY**



**VETERINARY INSTRUMENTS**



**KITS AND SETS**



**X-RAY AND NOVELTIES**



DIAGNOSTICS  
DIAGNÓSTICO



EMPIRE SURGICAL LTD (THE FUTURE OF HEALTHCARE)



100/...    101/...    102/...    103/...

» with fine and flexible but strong tips,  
 » con consejos finos y flexibles pero fuertes,  
 » com dicas finas e flexíveis, mas fortes



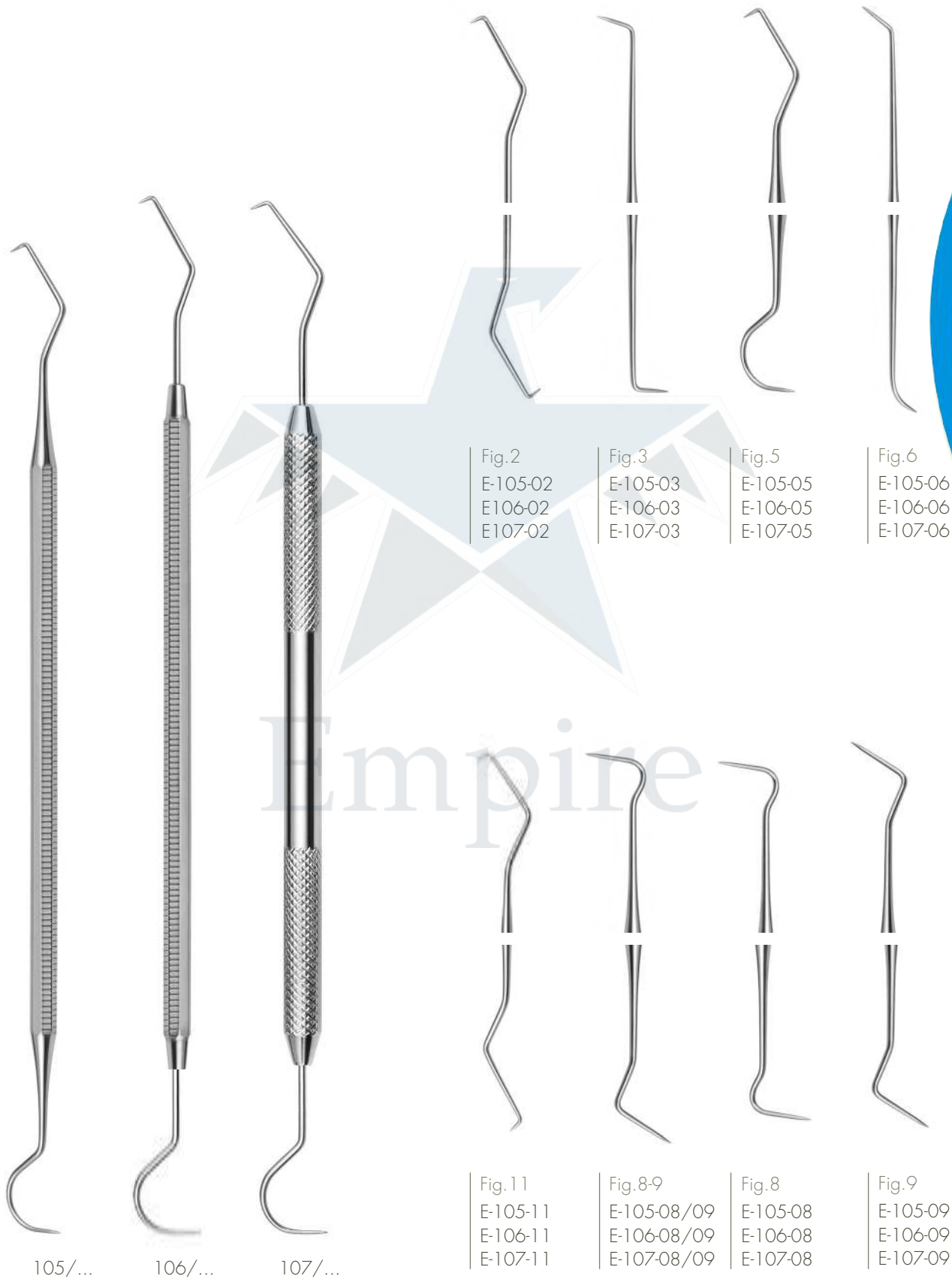



» All Tips suitable for handles on page 9  
 Todos los consejos adecuados paramaneja en la página 9  
 » Todas as dicas adequadas para alças na página 9



Fig.8 E-104-08	Fig.9 E-104-09	Fig.11 E-104-11	Fig.17 E-104-17	Fig.23 E-104-23
-------------------	-------------------	--------------------	--------------------	--------------------

explorer tips with thread  
 consejos de explorador con hilo  
 dicas do explorador com fio



MICROMIRRORS FS RHODIUM  
 MICROMIRRORES FS RODIO  
 MICROMIRRORS FS RHODIUM

plane  
 avión  
 E-200-08

magnifying  
 aumentador  
 E-200-06



Ø 3 mm E-201-10	Ø 5 mm E-201-20	3 x 6 mm E-201-30
--------------------	--------------------	----------------------

E-200-08

E-200-12

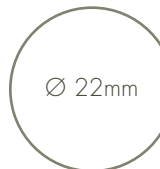

E-200-06

E-200-11

BOX WITH 12 PCS  
 CAJA CON 12 PCS  
 CAIXA COM 12 PCS



rhodium mirrors  
double side, N-4  
rhodiumspiegeloh  
lado doble, N-4  
espelhos de ródio  
lado duplo, N-4  
6 Pcs  
E-200-13



rhodium mirrors  
double side, N-5  
espejos de rodio  
lado doble, N-5  
espelhos de ródio  
lado duplo, N-5  
6 Pcs  
E-200-14



rhodium mirrors  
double side, N-5  
espejos de rodio  
lado doble, N-5  
espelhos de ródio  
lado duplo, N-5  
6 Pcs  
E-200-15



rhodium mirrors  
double side, N-3  
espejos de rodio  
lado doble, N-3  
espelhos de ródio  
lado duplo, N-3  
6 Pcs  
E-200-09



Empire



solid stainless  
acero inoxidable sólido  
sólido inoxidable  
E-200-00



hollow, chromium plated  
hueco, cromado  
oco, cromado  
E-200-01



hollow, stainless  
hueco, inoxidable  
oco, inoxidable  
E-200-02



hollow stainless  
hueco, inoxidable  
oco, inoxidable  
E-200-03



hollow, stainless  
hueco, inoxidable  
oco, inoxidable  
E-200-04



solid stainless  
acero inoxidable sólido  
sólido, inoxidable  
E-200-05



NEW DESIGN with measuring scale (0-30mm)  
NUEVO DISEÑO con escala de medición (0-30mm)  
NOVO DESIGN com escala de medição (0-30mm)  
E-200-51M



NEW DESIGN  
NUEVO DISEÑO  
NOVO DESIGN  
E-200-51

- » Suitable handles for explorers and mirrors on page 8
- » Mangos adecuados para exploradores y espejos en la página 8
- » Pegas adequadas para exploradores e espelhos na página 8



hollow stainless  
hueco, inoxidable  
oco, inoxidable  
E-200-45



LIGHT WEIGHT ALUMINIUM HANDLE  
MANGO DE ALUMINIO DE PESO LIGERO



aluminium, green  
aluminio, verde  
aluminio, verde  
E-200-22



aluminium, silver  
aluminio, plata  
aluminio, prata  
E-200-23



aluminium, yellow  
aluminio, amarillo  
aluminio, amarelo  
E-200-24



aluminium, red  
aluminio, rojo  
aluminio, vermelho  
E-200-25



solid stainless  
acero inoxidable sólido  
sólido inoxidável  
E-200-33



solid stainless  
acero inoxidable sólido  
sólido inoxidável  
E-200-19



solid stainless  
acero inoxidable sólido  
sólido inoxidável  
E-200-20



solid stainless  
acero inoxidable sólido  
sólido inoxidável  
E-200-35

FURCATION PROBE  
 SONDA DE FURCACIÓN  
 SONDA DE FUGIÇÃO

1-2-3-5-7-8-9-10



WILLIAMS 23W  
 E-405-23W

1-2-3-5-7-8-9-10  
 flat flach plano



GOLDMAN-FOX-WILLIAMS  
 E-405-PGFW



NABERS 2N  
 E-405-02N



NABERS 2N  
 colour coded  
 código de color  
 codificado por  
 cores  
 E-405-02NC-V

3-6-8-11



E-405/23-CP8

3,5-5,5-8,5-11,5



E-405-23-WHO



ED



1-2-3-5-7-8-9-10

WILLIAMS  
without color coding  
sin codificación de color  
sem codificação de cores  
E-405-W  
E-405-W-ED



1-2-3-5-7-8-9-10

CP10  
E-405-CP10



1-2-3-5-7-8-9-10  
flat flach plano

GOLDMAN-FOX PGF  
E-405-PGF



3-6-8-11

CP11  
E-405-CP11



3-6-9-12

CP12  
E-405-CP12  
E-405-CP12-ED

1-2-3-4-5-6-7-8-9  
10-11-12-13-14-15



CP15  
E-405-CP15  
E-405-CP15/ED

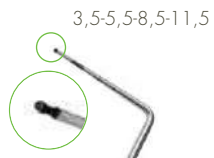

3,5-5,5-8,5-11,5

WHO  
E-405-WHO  
E-405-WHO/ED

» special color coating  
not fading after sterilization

» recubrimiento de color especial,  
sin decoloración después de ,  
la esterilización

» revestimento de cor especial,  
não desaparecendo após a  
esterilização





Empire

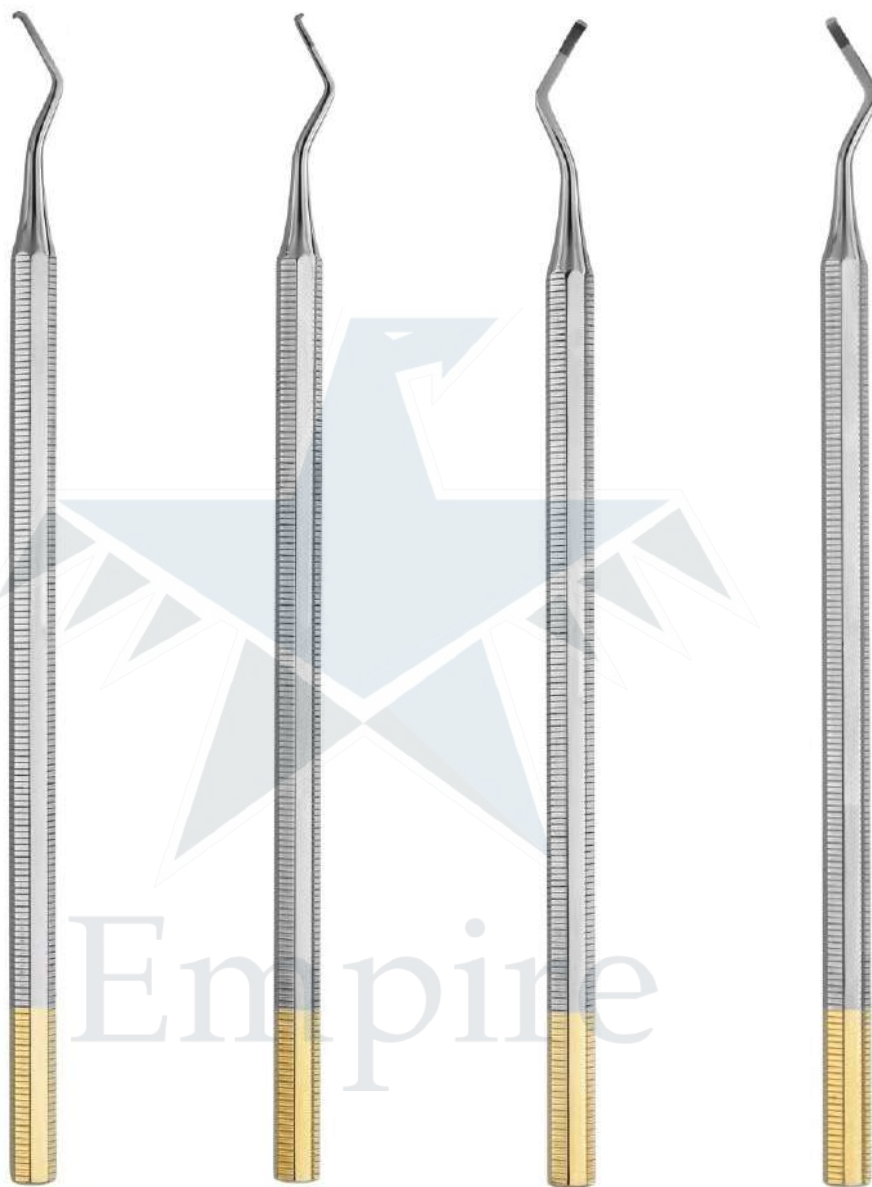

curette how N.10  
curette cómo N.10  
cureta como N.10  
[ 6mm  
E-410-10

curette how N.11  
curette cómo N.11  
cureta como N.11  
[ 6mm  
E-410-11

curette how N.12  
curette cómo N.12  
cureta como N.12  
[ 6mm  
E-410-12

curette how N.13  
curette cómo N.13  
cureta como N.13  
[ 6mm  
E-410-13

- » Picking up too small objects to be easily handles with the human hands.
- » Recoger objetos demasiado pequeños para manipularlos fácilmente con las manos humanas
- » Você não encontrou seu instrumento preferido ? Nós fabricamos de acordo com sua especificação!

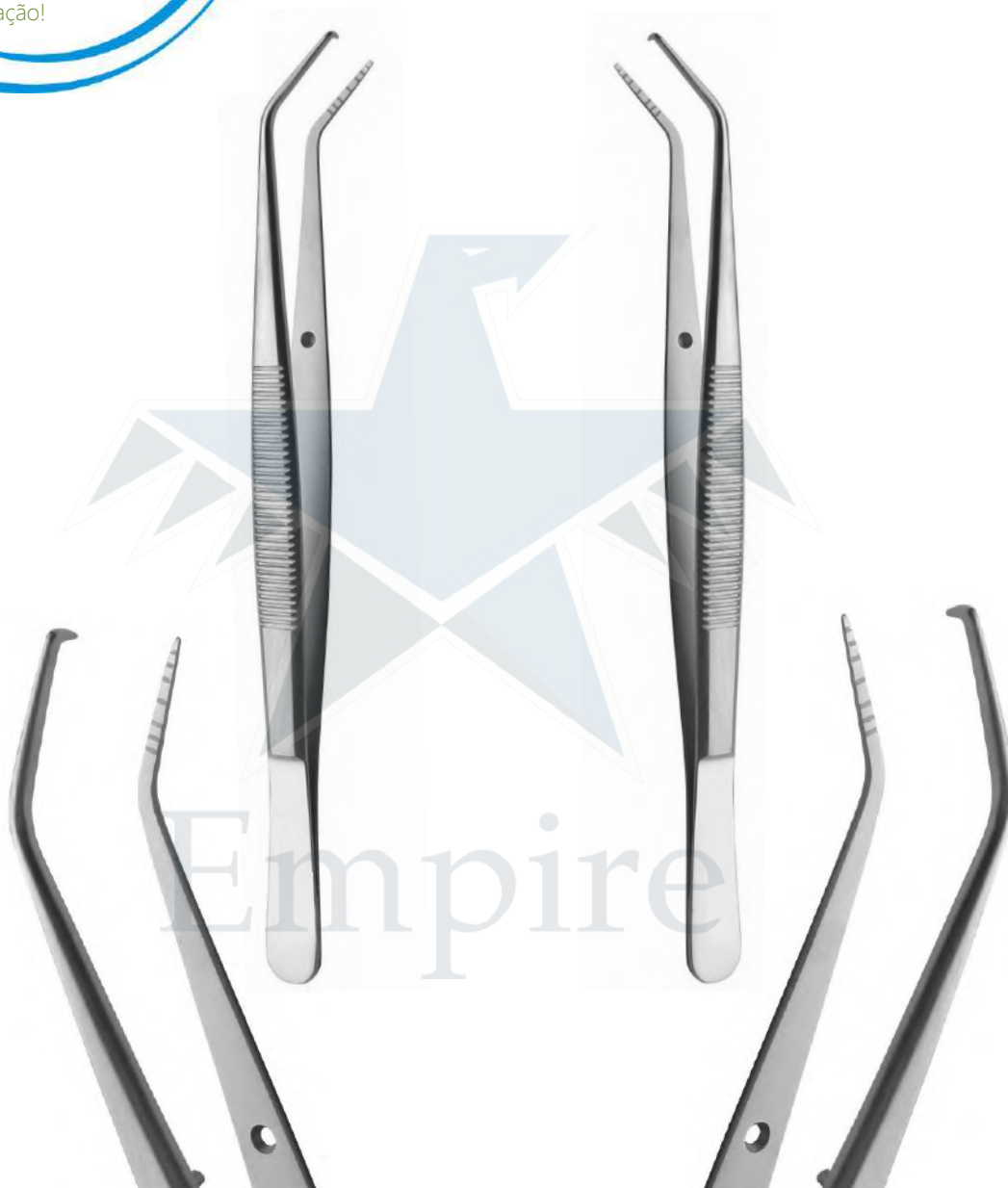

crane kaplan, right  
grúa kaplan, derecha  
guindaste kaplan, direito  
[ 155 mm  
E-180-03R

crane kaplan, left  
crane kaplan, izquierda  
guindaste kaplan, esquerda  
[ 155 mm  
E-180-03L



LONDON COLLEGE  
E-180-05



LONDON COLLEGE  
diamond coated  
recubierto de diamante  
revestido de diamante  
E-180-05D



LONDON COLLEGE  
with lock  
con cerradura  
com bloqueio  
E-180-06



LONDON COLLEGE  
smooth handle  
mango liso  
alça lisa  
E-180-10



MILLER  
Articulating paper forceps  
Pinzas de papel articuladas  
Pinça articulada de papel  
E-180-01



FLAGG  
smooth handle  
mango liso  
alça lisa  
E-180-11



MERIAM  
E-180-09



PERRY  
E-180-08



CRANE KAPLAN  
Pocket Markers  
Marcadores de bolsillo  
Marcadores de bolso  
E-180-03R



CRANE KAPLAN  
E-180-03L



## TOOTH TWEEZER TOE (TURN OVER ENDS)

Absence of welding leads to:  
Higher corrosion resistance  
easier to clean

## PINZA DE DIENTES TOE (GIRE LOS EXTREMOS)

La ausencia de soldadura conduce a:  
Mayor resistencia a la corrosión  
más fácil de limpiar

## PINÇA DO DENTE TOE (ENCERRAMENTO)

Ausência de soldagem leva a:  
Maior resistência à corrosão  
mais fácil de limpar



NEW NUEVO

COLLEGE TOE  
Turn over ends  
Dar la vuelta termina  
virar extremidades  
150mm  
E-180-05T

MERIAM TOE  
Turn over ends  
Dar la vuelta termina  
virar extremidades  
160mm  
E-180-09T

RESTORATIVE  
RESTAURATIVO



[www.empiresurgical.co.uk](http://www.empiresurgical.co.uk)

# HANDLES

# MANIJAS



## Octagonal handle

Mango octogonal  
Alça octogonal  
Ø 5,5mm



## Round handle solid

Manija redonda sólida  
Punho redutor sólido  
Ø 6mm



## Hollow handle

Mango hueco  
Alça oca  
Ø 8mm



## NEWDESIGN

NUEVO DISEÑO  
NOVO DESIGN  
Ø 8mm



## NEWDESIGN HANDLE

- New shape for comfortable and non-exhausting working even over a long period
- Ø 8mm, extra light
- Safe grip even during working with wet hands or gloves because of the special serration
- Modern and shapely design
- Easy cleaning

## NUEVO MANILLAR DE DISEÑO

- forma nuevo para cómodo y trabajo no agotador incluso durante un largo período
- Ø 8 mm, luz extra
- Agarre seguro incluso durante el trabajo con manos mojadas o guantes debido a la serrado especial
- Diseño moderno y bien proporcionado
- Fácil limpieza

## NOVO PUNHO DO PROJETO

- Forma novo para trabalho confortável e não exaustivo, mesmo durante um longo período
- Ø 8mm, luz extra
- Aderência segura mesmo durante o trabalho com mãos ou luvas molhadas por causa da serração especial
- Design moderno e bem feito
- Limpeza fácil

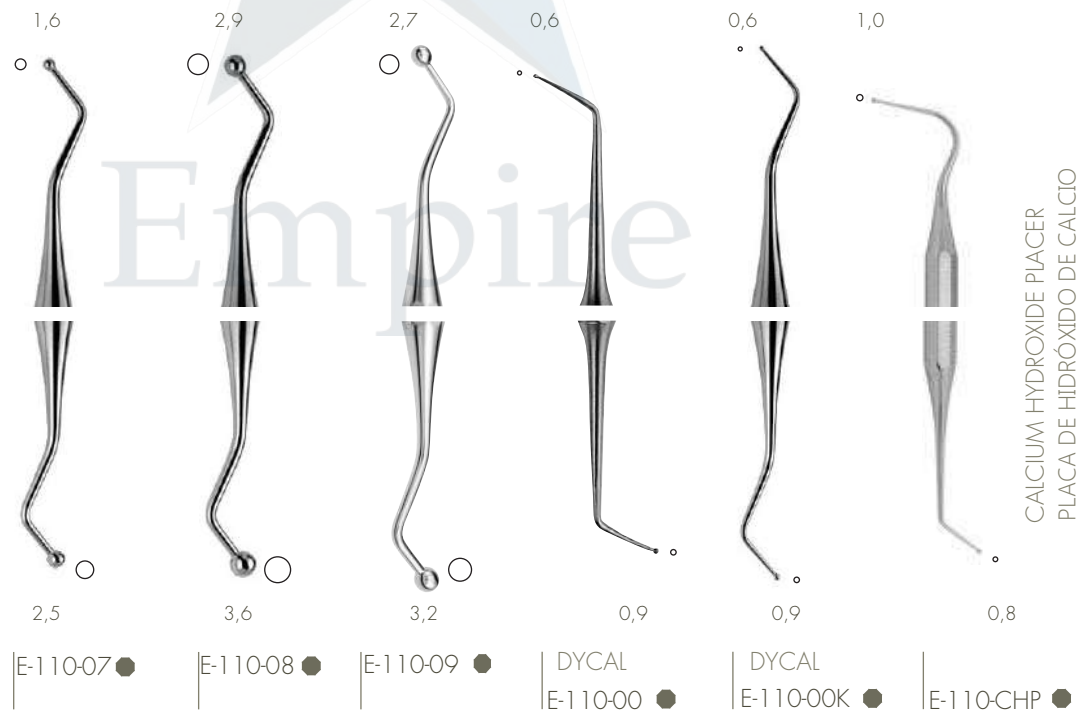
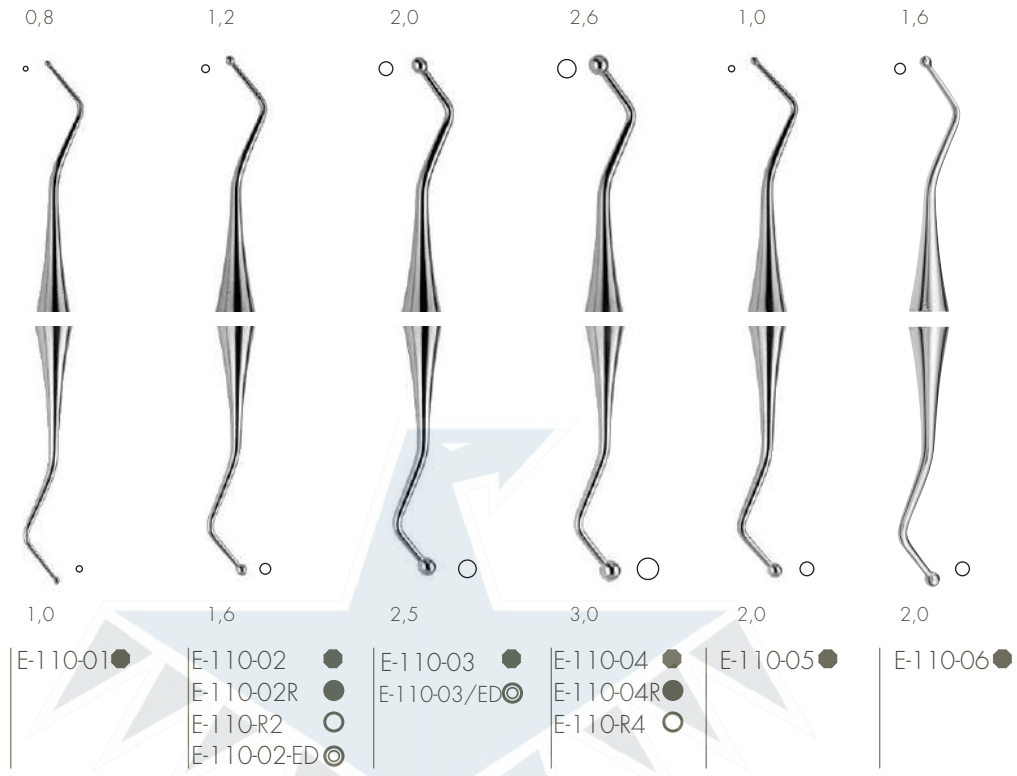

CALCIUM HYDROXIDE PLACER  
PLACA DE HIDRÓXIDO DE CALCIO  
INSTRUMENTO DE PLATZER DE HIDRÓXIDO DE CALCIO

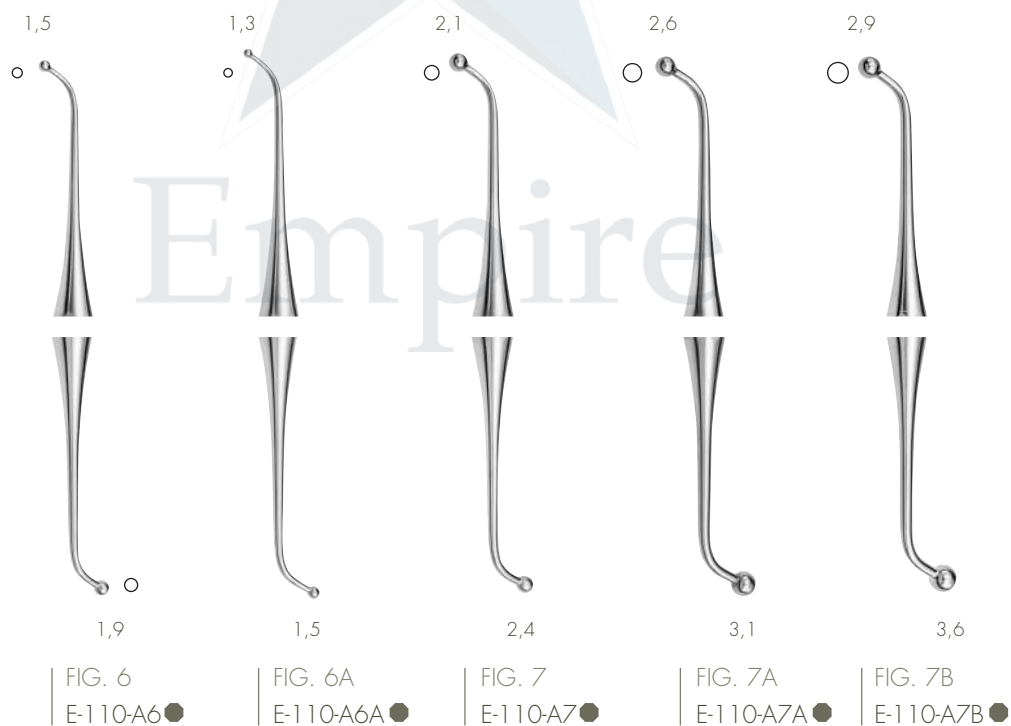
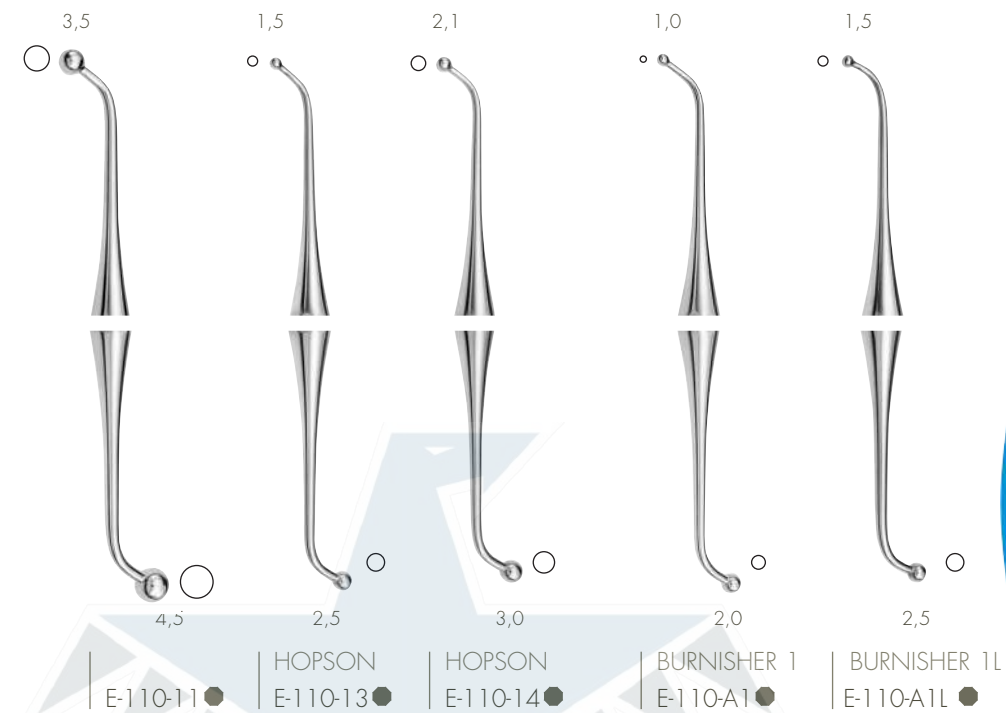

Octagonal handle  
Mango octogonal  
Alça octogonal  
Ø 5,5mm



Round handle solid  
Manija redonda sólida  
Punho redutor sólido  
Ø 6mm



Hollow handle  
Mango hueco  
Alça oca  
Ø 8mm



NEWDESIGN  
NUEVO DISEÑO  
NOVO DESIGN  
Ø 8mm





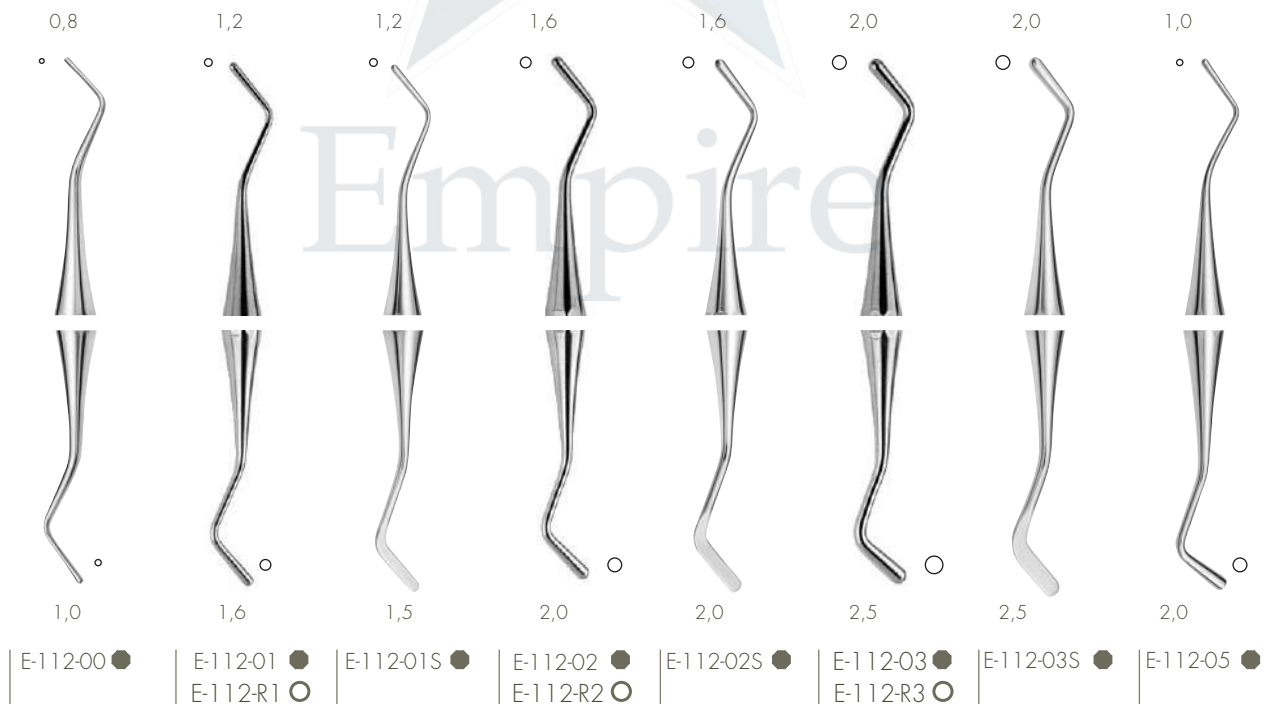
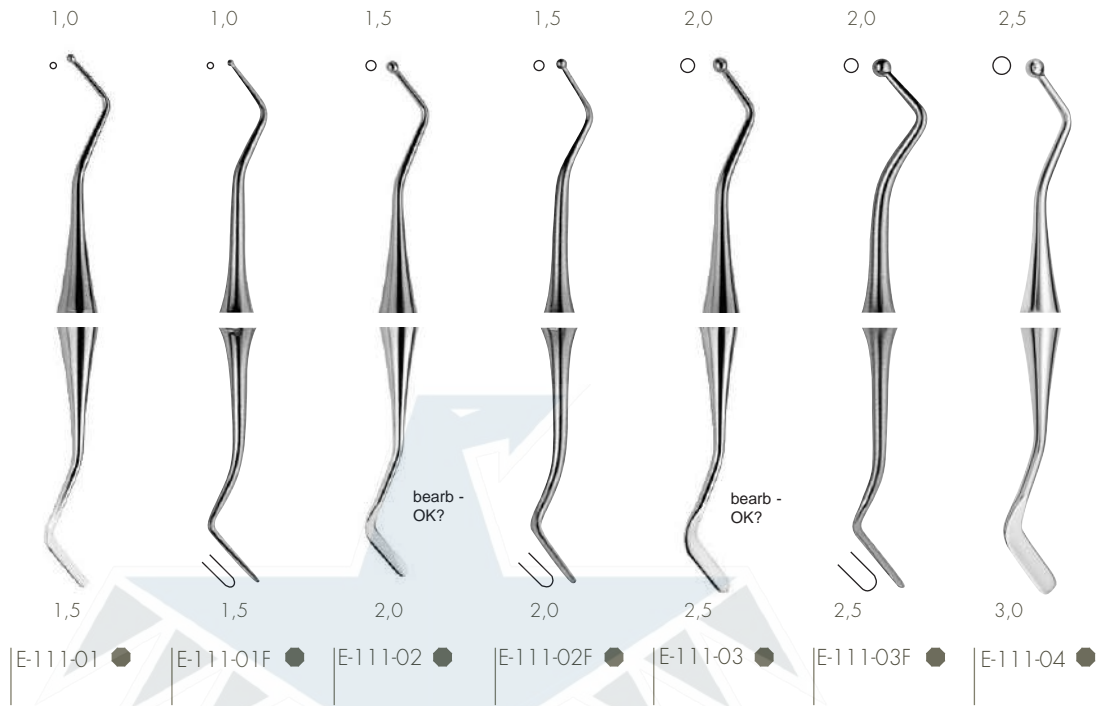

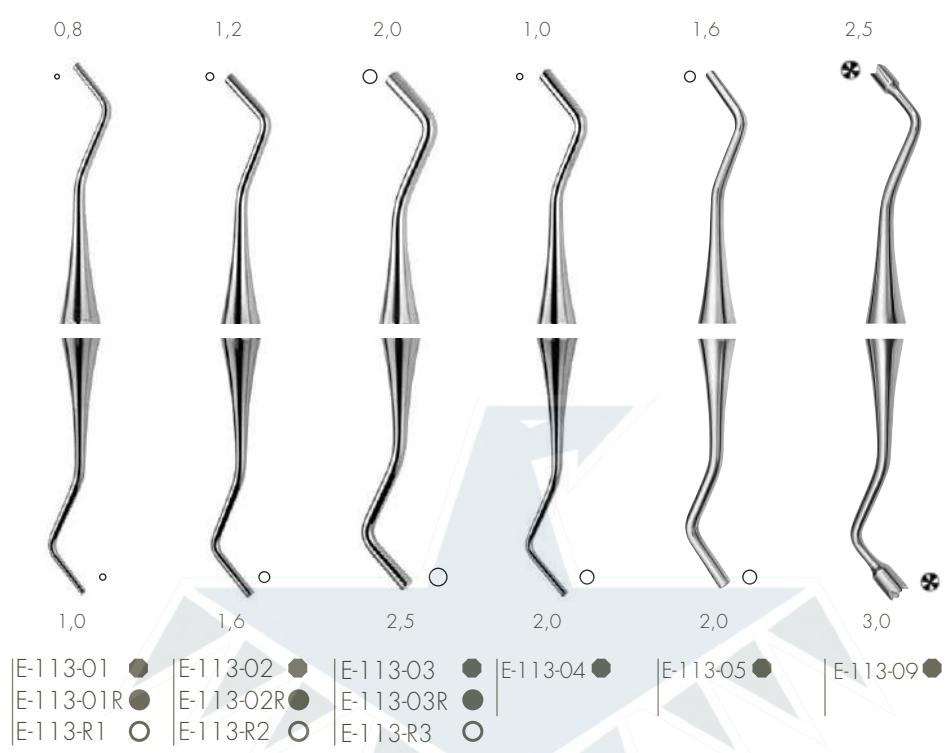

» You did not find your preferred instrument? We manufacture according to your specificatio!

» No encontraste tu preferido instrumento? Nosotros fabricamos de acuerdo a su especificación!

» Você não encontrou seu instrumento preferido ? Nós fabricamos de acordo com sua especificação!

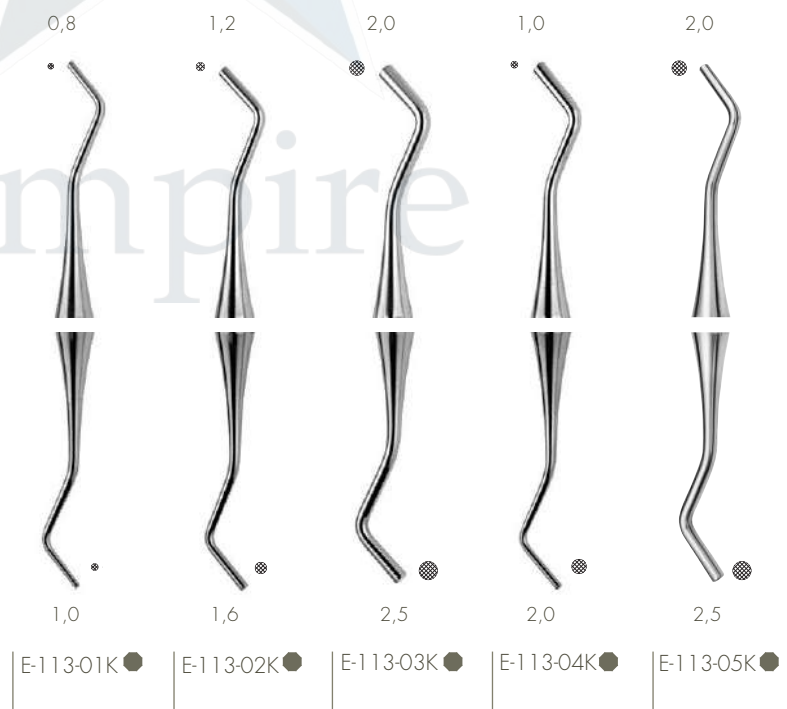

**Octagonal handle**  
Mango octogonal  
Alça octogonal  
Ø 5,5mm



**Round handle solid**  
Manija redonda sólida  
Punho redutor sólido  
Ø 6mm



**Hollow handle**  
Mango hueco  
Alça oca  
Ø 8mm



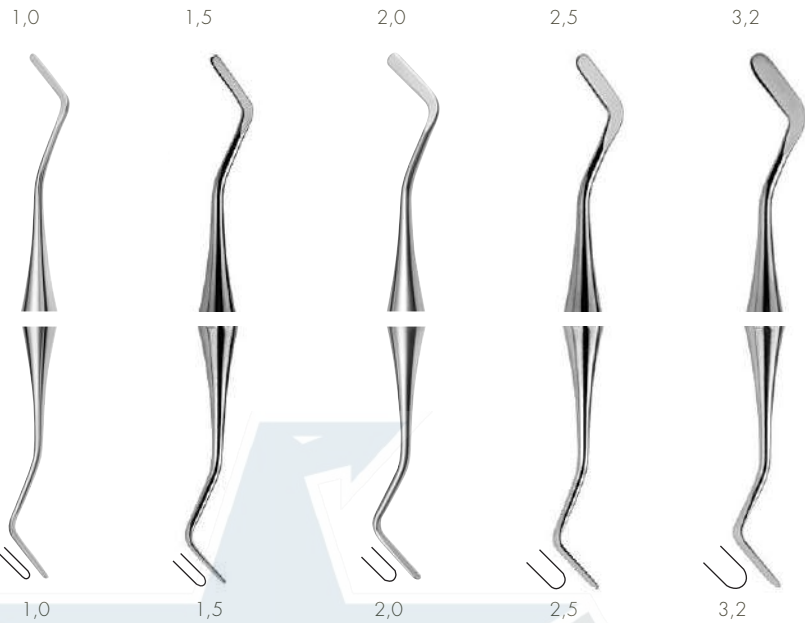

- |             |               |               |            |            |
|-------------|---------------|---------------|------------|------------|
| E-114-00 ●  | E-114-01 ●    | E-114-02 ●    | E-114-03 ● | E-114-04 ● |
| E-114-00R ○ | E-114-R1 ○    | E-114-R2 ○    | E-114-R3 ○ |            |
|             | E-114-01-ED ⊙ | E-114-02/ED ⊙ |            |            |

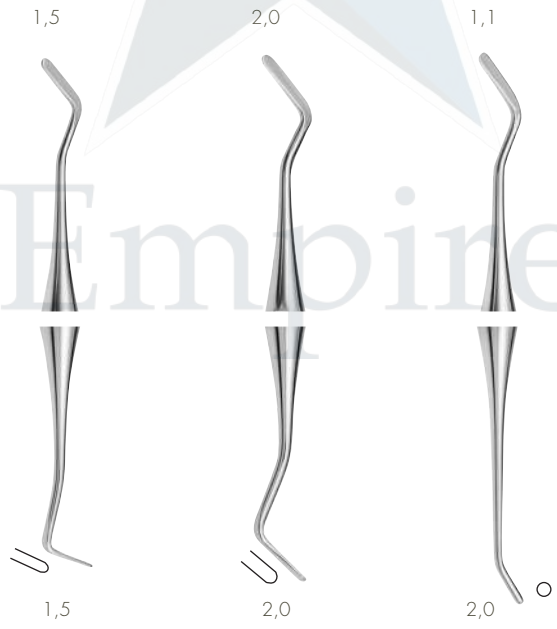

- |              |               |               |
|--------------|---------------|---------------|
| E-114-P8A ●  | E-114-P4 ●    | E-114-P6 ●    |
| E-114-P8AR ● | E-114-P4R ●   | E-114-P6R ●   |
|              | E-114-P4/ED ⊙ | E-114-P6/ED ⊙ |

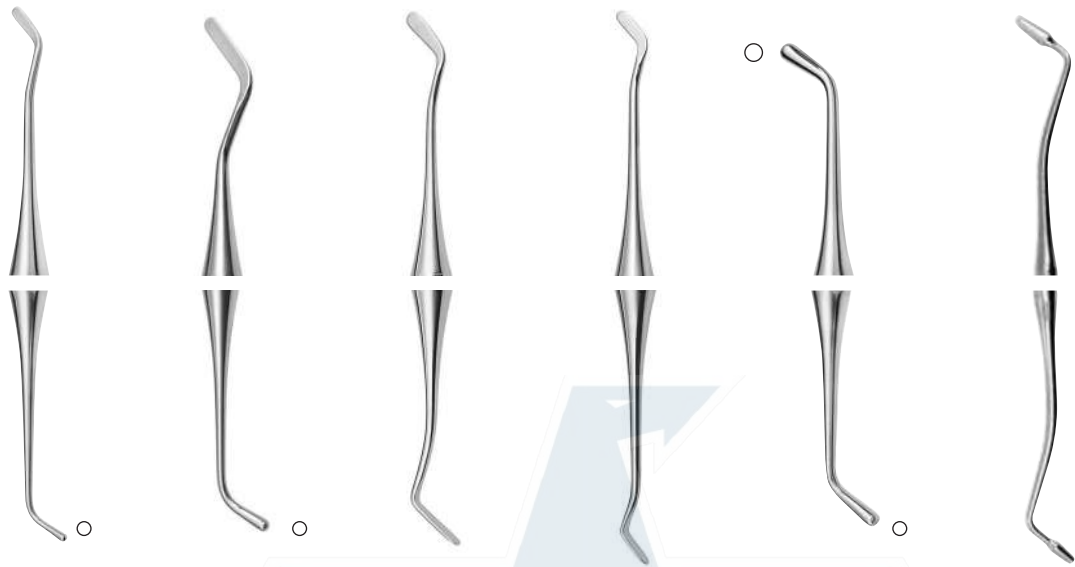

E-114-PFI1 ●

E-114-PFI3 ●

E-114-PFI14 ●

E-114-PFI15 ●  
E-114-PFI15/ED ◎

E-114-PFI49 ●

E-114-PFI109 ●  
E-114-PFI109/ED ◎

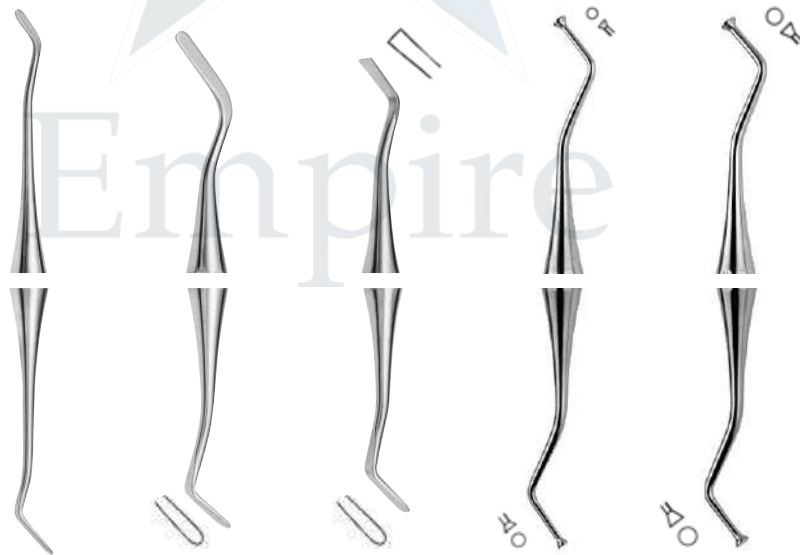

E-114-PFI185 ●

E-114-06 ●

E-114-06S ●

PLANATOR  
E-115-01 ●

PLANATOR  
E-115-02 ●

Octagonal handle  
Mango octogonal  
Alça octogonal  
Ø 5,5mm



Round handle solid  
Manija redonda sólida  
Punho redutor sólido  
Ø 6mm



Hollow handle  
Mango hueco  
Alça oca  
Ø 8mm



NEW DESIGN  
NUEVO DISEÑO  
NOVO DESIGN  
Ø 8mm



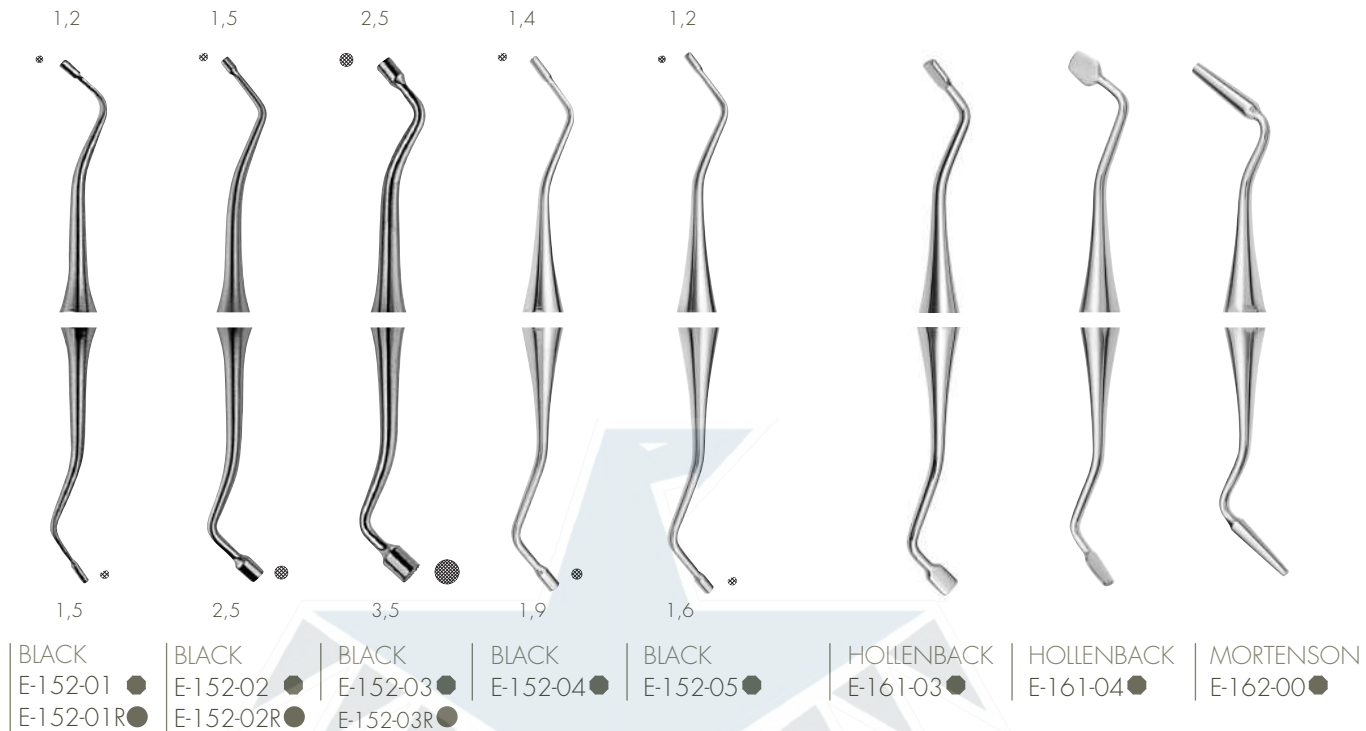



2,0



3,0

2,5



3,5



WESTCOTT 21  
 E-150-01 ●  
 E-150-01R ●  
 E-150-01/ED◎

WESTCOTT 21B  
 E-150-02 ●  
 E-150-02R ●  
 E-150-02/ED◎

E-150-B1 ●  
 E-150-B1R ●

E-165-03 ●  
 E-165-03R ●  
 E-165-03/ED◎

WHITE  
 E-150-29/31 ●

WHITE  
 E-150-34/29 ●

TRATAMIENTO CONSERVADOR  
 BURNISHERS

BURNISHERS CONSERVATIVE TREATMENT



WHITE 28  
 E-150-28 ●

WHITE 29  
 E-150-29 ●

WHITE 31  
 E-150-31 ●

WHITE 32  
 E-150-32 ●

WHITE 33  
 E-150-33 ●

WHITE 34  
 E-150-34 ●

Octagonal handle  
 Mango octogonal  
 Alça octogonal  
 Ø 5,5mm



Round handle solid  
 Manija redonda sólida  
 Punho redondo sólido  
 Ø 6mm



NEWDESIGN  
 NUEVO DISEÑO  
 NOVO DESIGN  
 Ø 8mm





1,7



2,1



» special stainless steel, perfect grinding for long lasting sharpness  
 » acero inoxidable especial, rectificado perfecto para nitidez de larga duración  
 » aço inoxidável especial, moagem perfeita para nitidez duradoura

E-134-14 ●  
 E-135-14 ●

DARBY-PERRY  
 220/221

E-134-15 ●  
 E-135-15 ●

1,5



1,5



1,7



2,5



3,0



EXC 5  
 E-134-16 ●  
 E-135-16 ●

EXC 17  
 E-134-17 ●  
 E-135-17 ●

EXC 18  
 E-134-18 ●  
 E-135-18 ●

EXC 19  
 E-134-19 ●  
 E-135-19 ●

WHITE 20  
 E-134-20 ●  
 E-135-20 ●

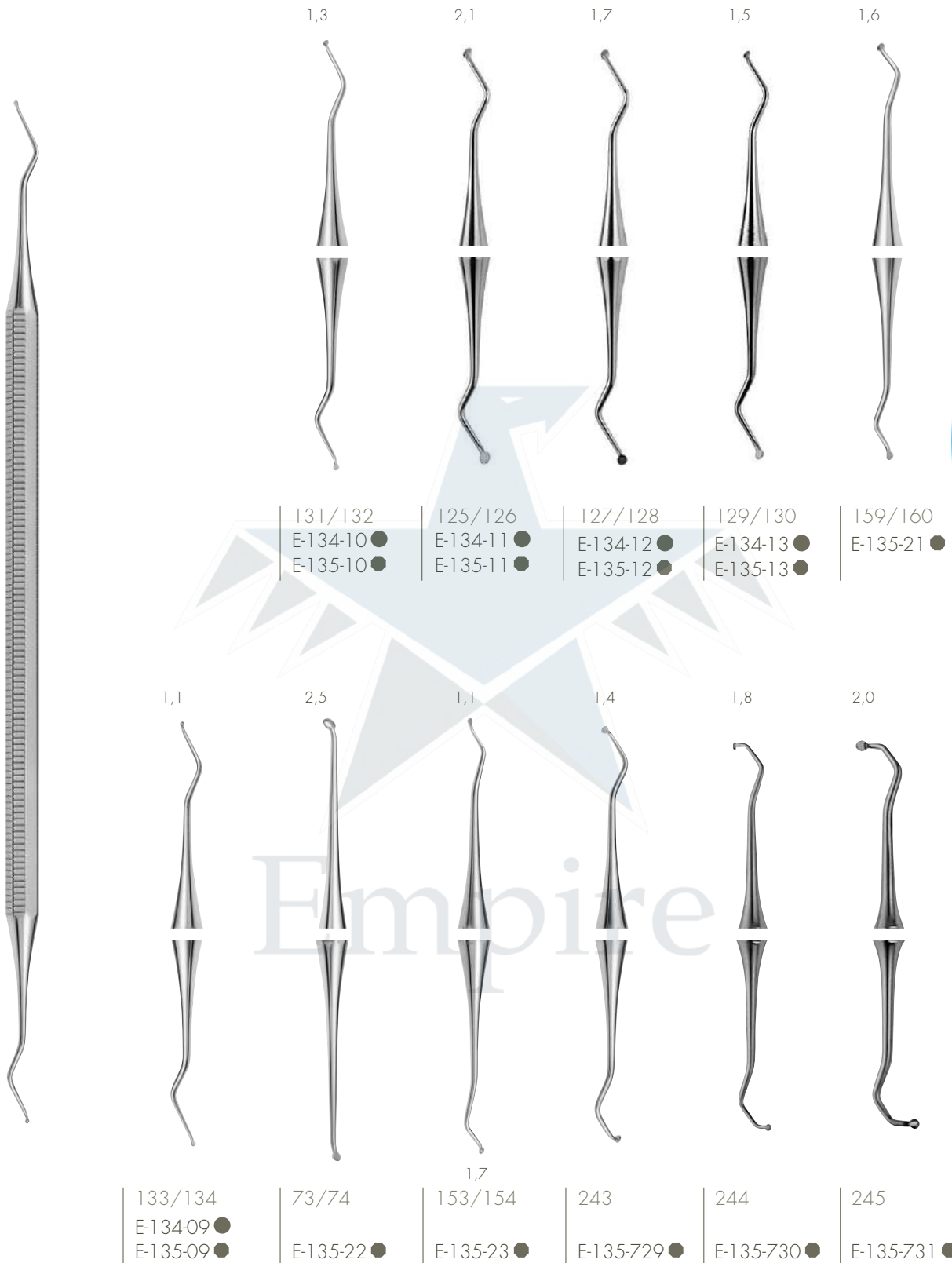

TRATAMIENTO CONSERVADOR  
EXCAVADORAS

EXCAVATORS CONSERVATIVE TREATMENT

Octagonal handle  
Mango octogonal  
Alça octogonal  
Ø 5,5mm



Round handle solid  
Maniija redonda sólida  
Punho redondo sólido  
Ø 6mm



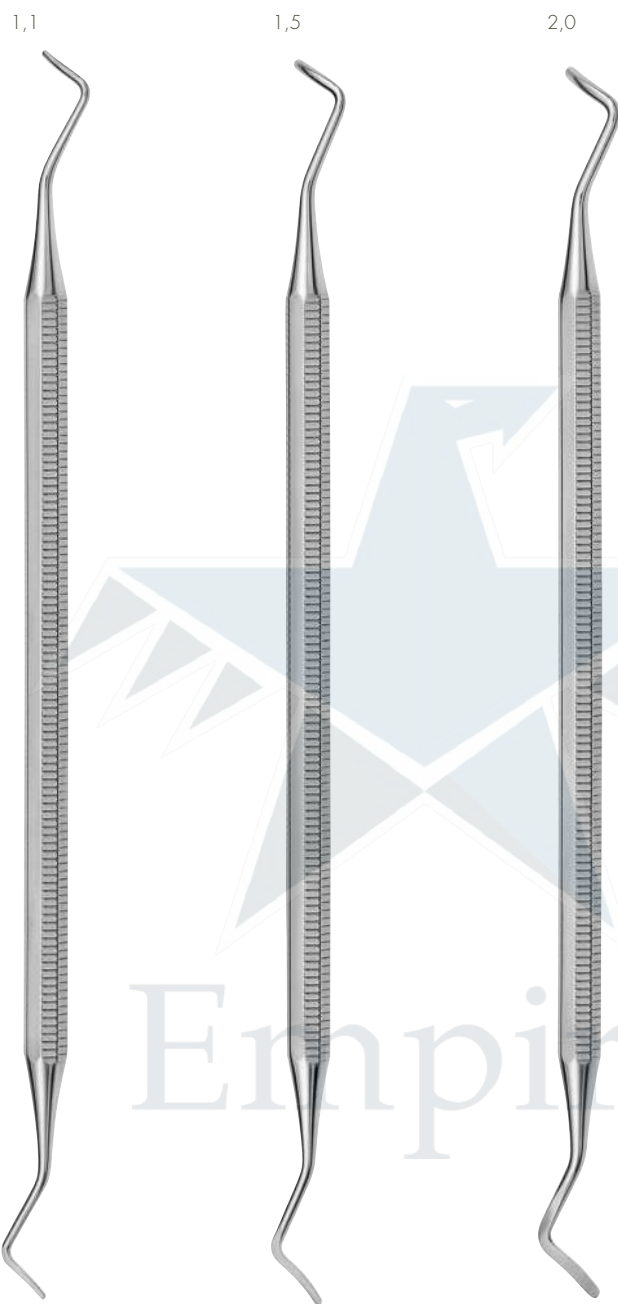

- » special stainless steel, perfect grinding for long lasting sharpness
- » acero inoxidable especial, rectificado perfecto para nitidez de larga duración
- » aço inoxidável especial, moagem perfeita para nitidez duradoura

| E-134-S11 ●  
| E-135-S11 ●

| E-134-S15 ●  
| E-135-S15 ●

| 134/S20 ●  
| 135/S20 ●

# SPECIAL ESPECIAL

# ENDO EXCAVATORS

## EXCAVADORAS ENDO

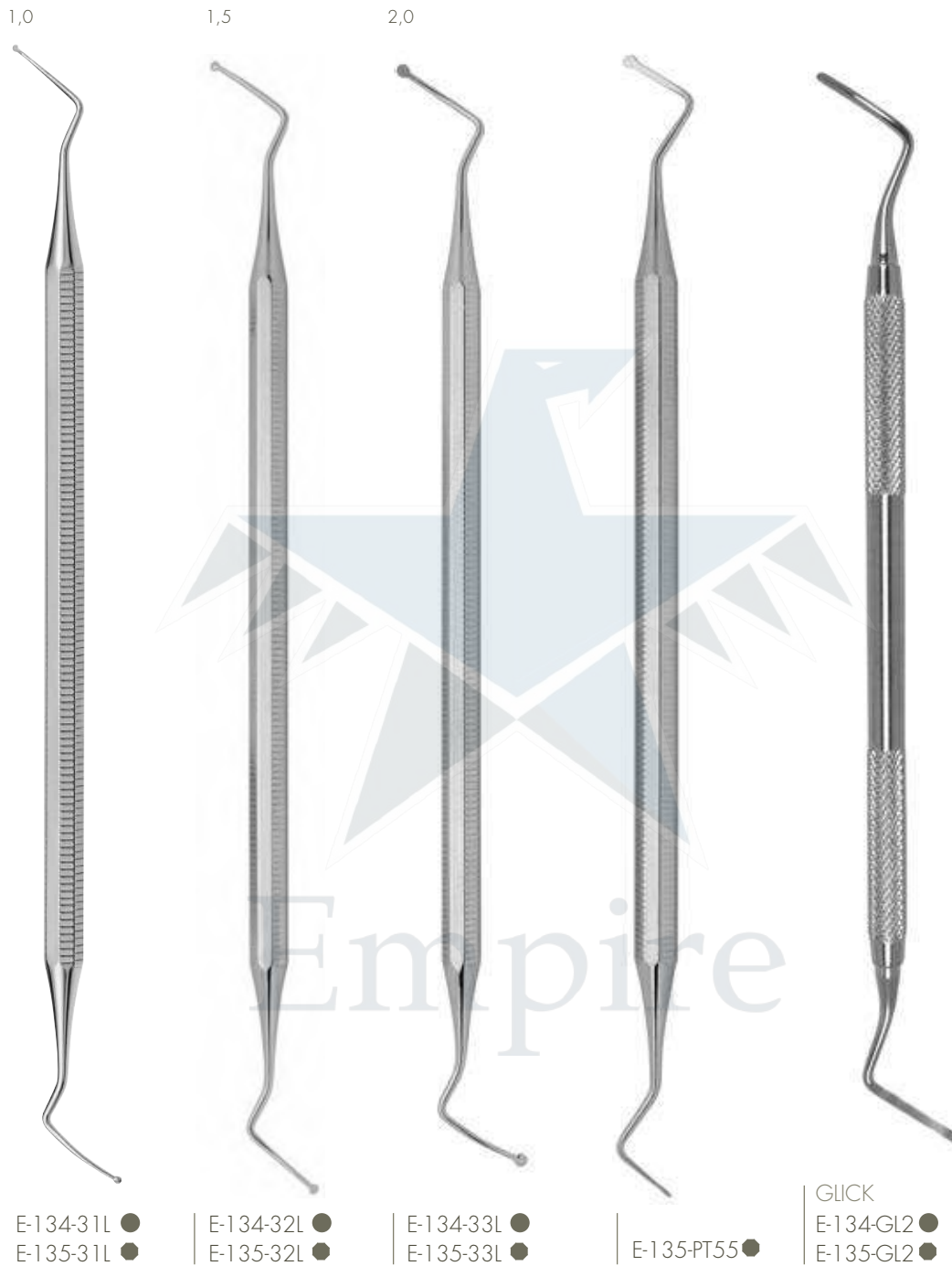

Octagonal handle  
Mango octogonal  
Alça octogonal  
Ø 5,5mm



Round handle solid  
Manija redonda sólida  
Punho redondo sólido  
Ø 6mm



TRATAMIENTO CONSERVADOR  
ENDO EXCAVATORS

ENDO EXCAVATORS CONSERVATIVE TREATMENT





NEW DESIGN

Ø 8mm, extra light safe grip handles  
Ø 8 mm, agarraderas extra ligeras y seguras

Our COMPO-FILL instruments have a special high mirror polished TiN (Titanium Nitrid) coating that avoids the sticking of the composite material on the working tips. This TiN-Coating is a lot more harder than stainless steel and withstands therefore diverse cleaning and sterilization processes.

Nuestros instrumentos COMPO-FILL tienen un alto especial TiN pulido (Nitruro de titanio) revestimiento que evita la adherencia del material compuesto en las puntas de trabajo. Este recubrimiento de TiN es mucho más duro que el acero inoxidable y, por lo tanto, es resistente diversos procesos de limpieza y esterilización.

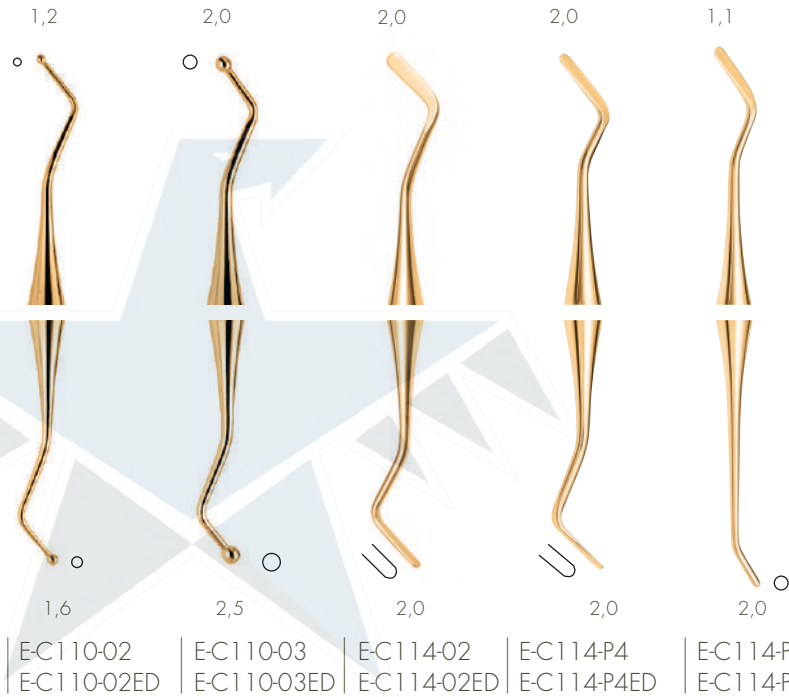

ND = with NEWDESIGN Handle  
ND = con mango NUEVO DISEÑO  
ND = com NOVO DESIGNHandle

» also available as Set  
» también disponible como conjunto  
» También disponible como Set

EC114-PF15  
EC114-PF15ED

WESTCOTT  
EC150-01  
EC150-01ED

WESTCOTT  
EC150-02  
EC150-02ED

MORTENSON  
EC162-00  
EC162-00ED

EC165-03  
EC165-03ED

## HEIDEMANN FLEXIBEL

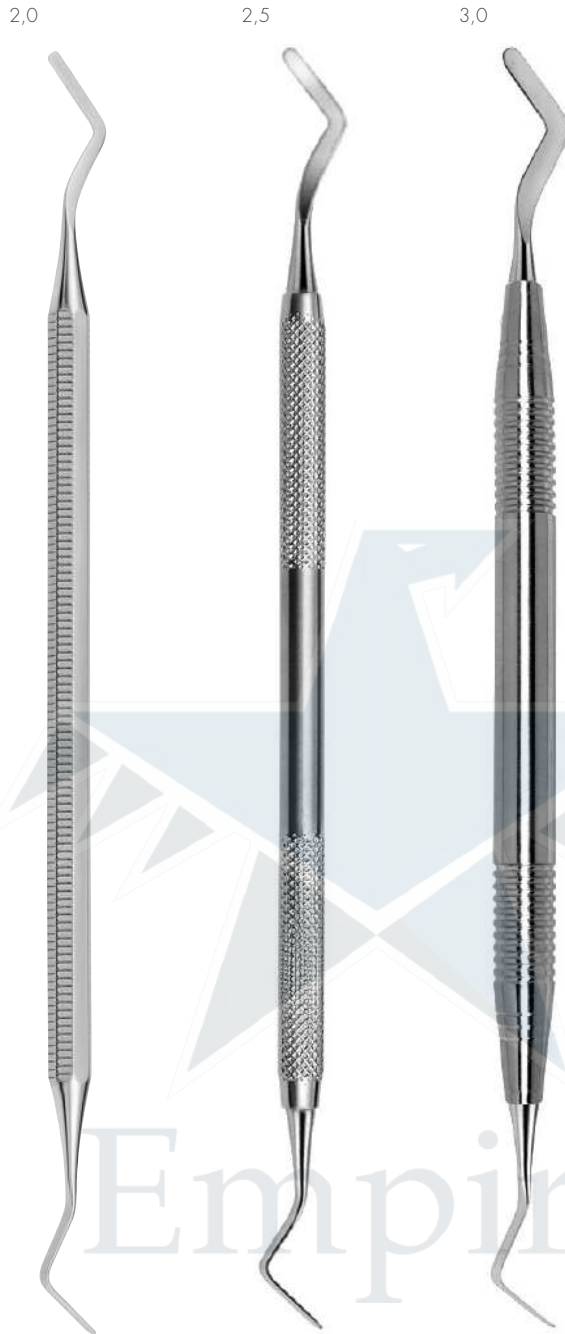

2,0	2,5	3,0
E-116-00 ●	E-116-01 ●	E-116-02 ●
E-116-00R ●	E-116-01R ●	E-116-02R ●
E-116-00/ED◎	E-116-01/ED◎	E-116-02/ED◎

Also available as COMPO-FILL with TiN coating

También disponible como COMPO-FILL con recubrimiento de TiN

Também disponível como COMPO-FILL com revestimento TiN

E-C116-00 ●	E-C116-01 ●	E-C116-02 ●
E-C116-00/ED◎	E-C116-01/ED◎	E-C116-02/ED◎

Octagonal handle  
Mango octogonal  
Alça octogonal  
Ø 5,5mm



Round handle solid  
Manija redonda sólida  
Punho redondo sólido  
Ø 6mm



NEWDESIGN  
NUEVO DISEÑO  
NOVO DESIGN  
Ø 8mm



- » soft flexible tips
- » a menudo consejos flexibles
- » pontas flexíveis macias

# BESTSELLER



DISCOID CLEOID  
89/92  
E-160-01 ●  
E-162-01 ●



DISCOID CLEOID  
1/2  
E-160-02 ●  
E-162-02 ●

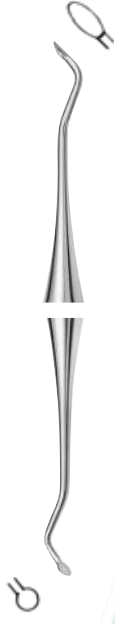

DISCOID CLEOID  
3/6  
E-160-03/06 ●  
E-162-03/06 ●



HOLLENBACK  
1/2  
E-160-H12 ●  
E-161-H12 ●



HOLLENBACK  
3  
E-160-H3 ●  
E-161-H3 ●



HOLLENBACK  
3S  
E-160-H3S ●  
E-161-H3S ●



FRAHM  
E-160-73 ●



FRAHM  
E-160-74 ●



FRAHM  
E-160-78 ●  
E-162-78 ●



WILAND  
E-160-W ●  
E-161-W ●



WARD  
E-160-W1 ●  
E-162-W1 ●



WARD  
E-160-W2 ●  
E-162-W2 ●



INTERPROXIMAL

E-160J2 ●  
E-162J2 ●



TUFT FIG. 1

E-160-T1 ●



TUFT FIG. 2

E-160-T2 ●



NYSTROEM

E-173-02 ●



BEALE

E-162-07A ●



BEALE

E-335-07A ○

Octagonal handle  
Mango octogonal  
Alça octogonal  
Ø 5,5mm



Round handle solid  
Maniija redonda sólida  
Punho redondo sólido  
Ø 6mm



Hollow handle  
Hohlgriff  
Alça oca  
Ø 8mm





LUNIATSCHEK  
Gauze Packers  
Empacadores de Gasa  
tampões Topfer  
E-117-01

Octagonal handle  
Mango octogonal  
Alça octogonal  
Ø 5,5mm



Round handle solid  
Manija redonda sólida  
Punho redondo sólido  
Ø 6mm

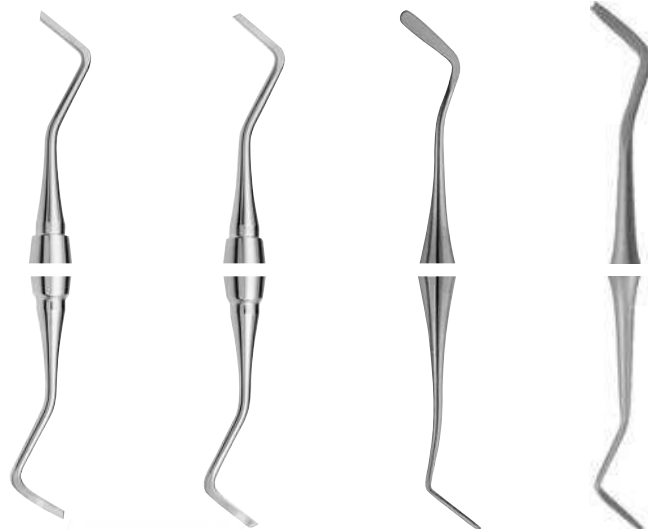

Gingival Margin Trimmer  
Trimmer de margen gingival  
Aparador de Margem Gingival

distal  
E-173-28 ●  
E-173-28R ●

mesial  
E-173-29 ●  
E-173-29R ●

Cord Packer Fadenstopfer  
serrado  
serrilhada  
E-173-04 ●

non-serrated  
no serrado  
não serrilhado  
E-173-05 ●

0,5-1,0mm  
E-173-06 ●

0,7-1,2mm  
E-173-07 ●

0,9-1,4mm  
E-173-08 ●

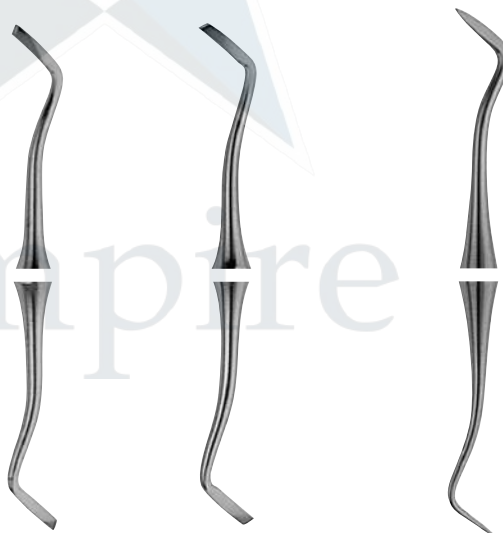

BLACK

distal  
E-171-77/78 ●

mesial  
E-171-79/80 ●

Filling Remover  
Eliminador de llenado  
Removedor de enchimento

double ended  
doble punta  
duplo fim  
E-170-01 ●

single ended  
single ended  
única terminou  
E-170-02 ●



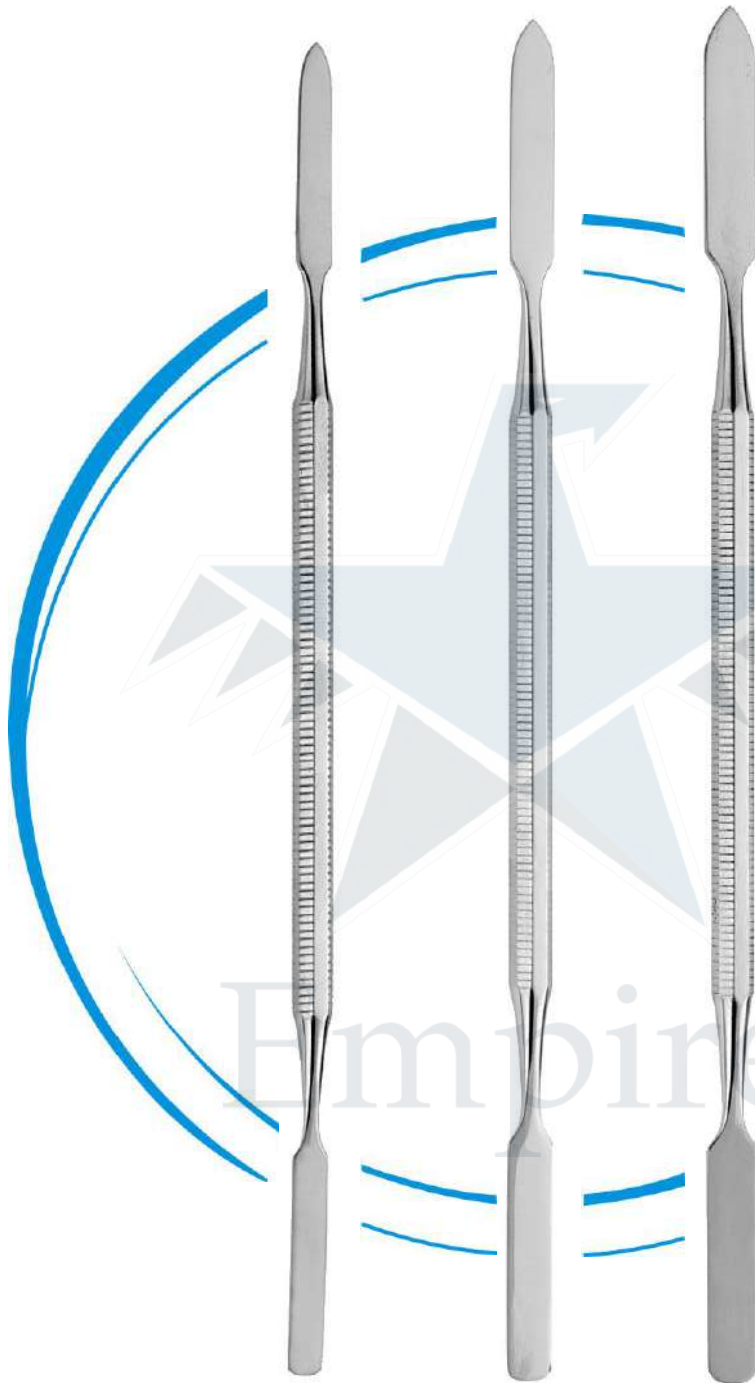

E-140-01

E-140-02

E-140-03

FLEXIBLE FLEXIBLE FLEXÍVEL

# BESTSELLER

CEMENT SPATULAS CONSERVATIVE TREATMENT

TRATAMIENTO CONSERVADOR  
ESPATULAS DE CEMENTO

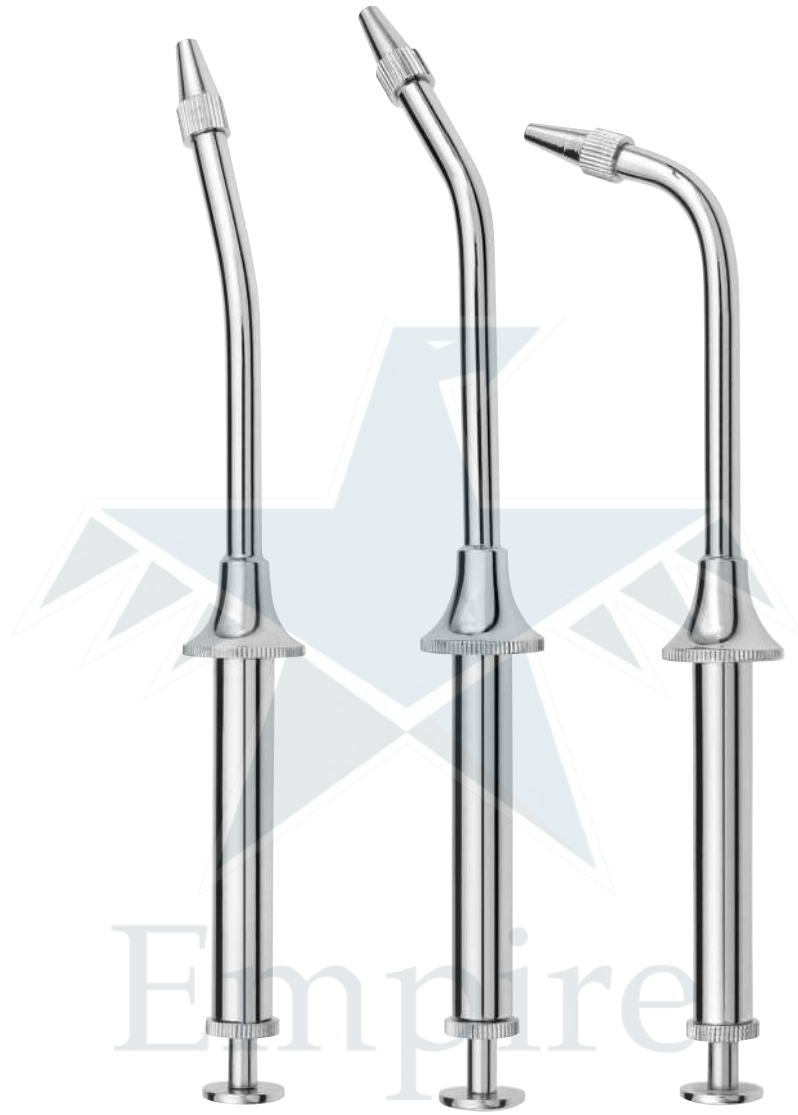

30°  
with metal tip  
con punta de metal  
com ponta de metal  
E-145-30

45°  
with metal tip  
con punta de metal  
com ponta de metal  
E-145-45

85°  
with metal tip  
con punta de metal  
com ponta de metal  
E-145-85

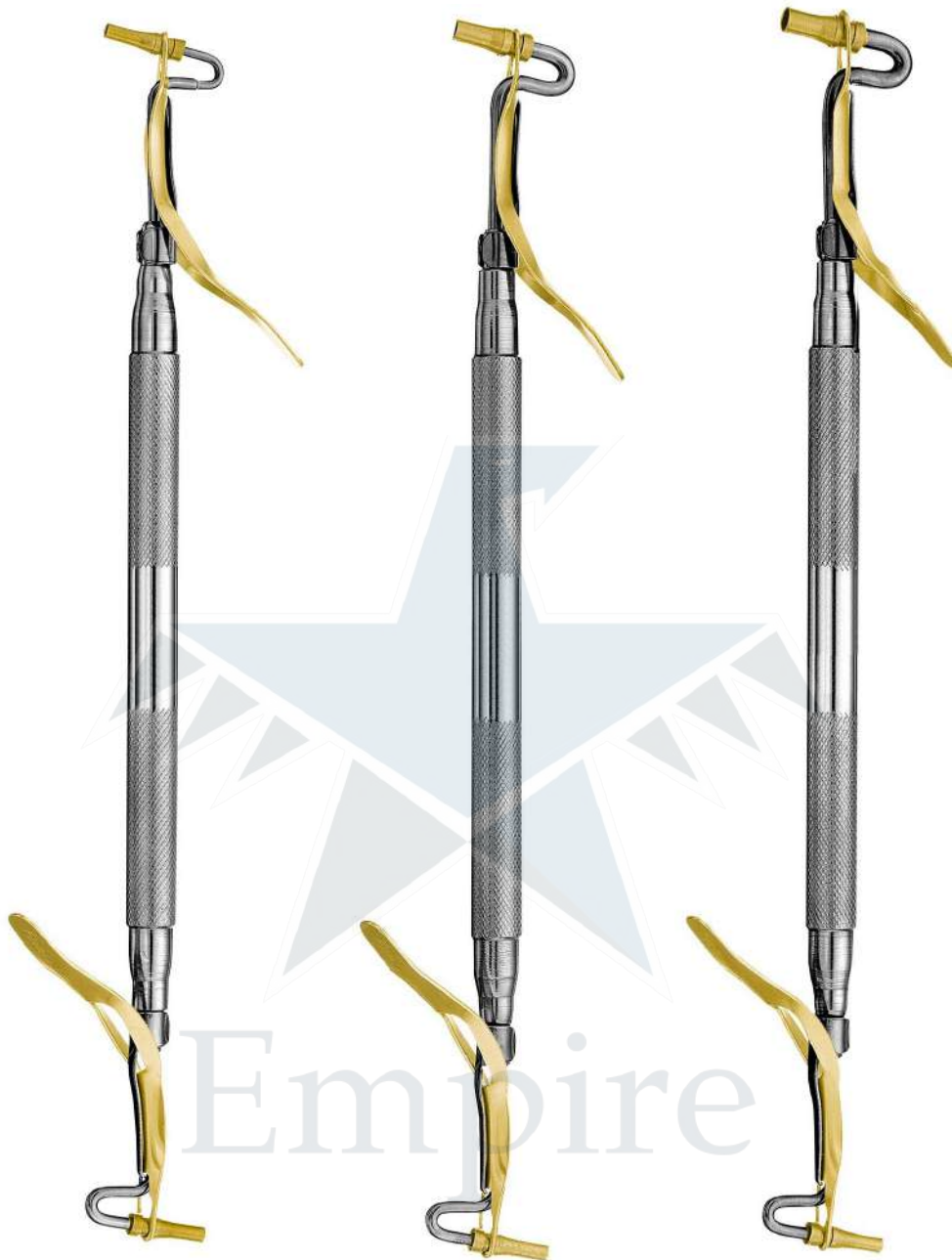

regular mini  
mini regular  
mini regular  
[ 1.5 x 2.0 mm  
E-146-07

regular large  
regular grande  
grande regular  
[ 2.8 x 2.0mm  
E-146-08

regular jumbo  
jumbo regular  
jumbo regular  
[ 3.2 x 2.0mm  
E-146-09



mini  
Mini  
mini  
[ 1.5mm  
E-146-11



large  
grande  
ampla  
[ 2.8mm  
E-146-12



regular  
regular  
regular  
[ 2.0mm  
E-146-13



mini  
Mini  
mini  
[ 1.5mm  
E-146-14



regular  
regular  
regular  
[ 2.0mm  
E-146-15



Copper Ring Removing  
Forceps, Straight  
Eliminación de anillo de cobre  
Pinzas, recto  
Pinças, Straight  
Anel de Cobre Removendo  
16cm  
E-119-17



Crown Removing Forceps  
Corona de extracción de fórceps  
Pinça de Remoção de Coroa  
E-119-13



S-U-Crown Butler  
with 2 insets  
S-U-Kronen Butler  
con 2 inserciones  
Mordomo S-U-Crown  
com 2 inserções  
E-119-33





PALTI  
Bone Ring Holding Forceps,  
Fórceps de sujeción del anillo de hueso  
Anel de Osso Segurando Pinças  
E-120-06



NENTWIG  
Bone Ring Holding Forceps  
Fórceps de sujeción del anillo de hueso  
Anel de Osso Segurando Pinças  
12.5 cm  
E-120-20



BARTH  
Bone Ring Holding Forceps  
Fórceps de sujeción del anillo de hueso  
Anel de Osso Segurando Pinças  
15 cm  
E-120-13

## Bone Ring Holding Forceps

The bone ring forceps allows for an optimal stabilization and precision treatment of the bone block. This results in an enormous workload relief for the dentist. It also serves to minimize risk (block movement or fracture). Because of the very fine threads an optimal adjustment of the setting is possible. The stable fixation also allows for the insertion of the osteosynthesis screw before implanting the bone block into the jaw.

## Fórceps de sujeción del anillo de hueso

El fórceps de anillo de hueso permite una estabilización óptima y tratamiento de precisión del bloqueo óseo. Esto resulta en un trabajo enorme load relief para el dentista. También sirve para minimizar el riesgo (bloqueo de movimiento o fractura). Debido a los hilos muy finos el ajuste óptimo de la configuración es posible. La fijación estable también permite para la inserción de theosteosynthesis atornillar antes de implantar el bloque óseo en la mandíbula.





Crown Remover with three tips  
Crown Remover con tres consejos  
Removedor de Coroa com três pontas

E-119-03



E-119-03A



E-119-03B



E-119-03C



Crown Removing Forceps  
Corona de extracción de fórceps  
Pinça de Remoção de Coroa

E-119-06



MAZOUCH  
E-119-22

Crown spreading pliers with exact grip and parallel opening easy placing and good view on the working area after opening the crown.

Alicates de expansión Crown con agarre exacto y apertura paralela colocación fácil y buena vista en el área de trabajo después de abrir la corona.

[ 140mm  
E-119-07

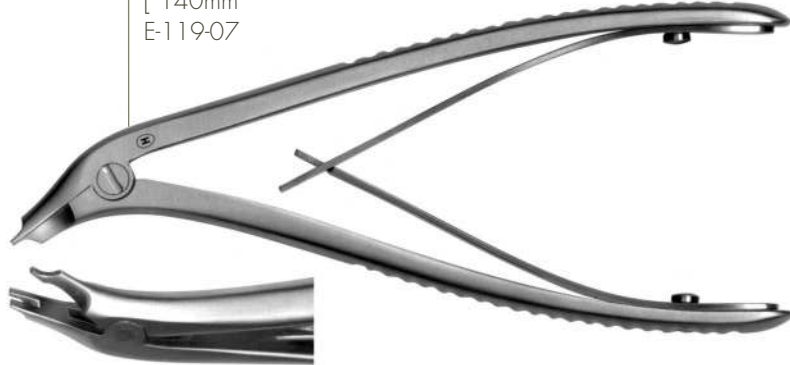

Crown trail/removing forceps with replaceable plastic inserts to carefully grab and remove crowns and bridges. Due to the elastic plastic inserts, damages especially on ceramic crowns can be avoided.

Pinzas de corte / extracción de corona con inserciones de plástico reemplazables para agarrar y eliminar coronas y puentes. Debido a las inserciones de plástico elásticas, daños especialmente en coronas de cerámica se puede evitar.

for upper jaws  
para mandíbulas superiores  
para maxilas superiores

E-119-08OK

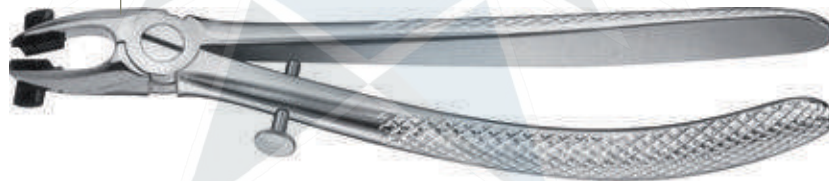

for lower jaws  
para mandíbulas inferiores  
para mandíbulas inferiores

E-119-08UK



american pattern  
patrón americano  
padrão americano  
119/8AM



pair of inserts  
par de insertos  
par de inserções  
E-119-08E



Montfor  
Plier crown slitter  
Cortadora de corona de alicates  
Alicate cortador de coroa  
180mm  
E-119-42



spare blade  
Cuchilla de repuesto  
lâmina de reposição  
E-119-43



Plier Crown Opener  
Alicates abridor de coronas  
Alicate Coroa Abridor  
150mm  
E-119-37



Plier Bergh Crown  
Coronas alicates Bergh  
Alicate cortador de coroa  
175mm  
E-119-57

PROSTODONCIA REMOVE LA CORONA

CROWN REMOVER PROSTHETICS



Crown plier, universal  
Alicates Crown universales  
Alicate coroa universal

140mm  
E-119-45



Crown holder plier  
Alicates de la corona  
Provisorien-Abnehme

125mm  
E-119-28



Crown remover  
Removedor de corona  
Removedor de coroa

180mm  
E-119-55



Crown remover with spring  
Provisorien-Abnehme  
Removedor de coroa com mola

145mm  
E-119-59



Kit double loop  
Kit doble lazo  
Loop Duplo Kit

E-119-62



Kit single loop  
Kit de lazo simple  
Loop único kit

E-119-63



Plier Crown Opener  
Alicates abridor de coronas  
Alicate Coroa Abridor

150mm  
E-119-46



Crown remover, automatic  
Removedor de corona,  
automático  
Provisorien-Abnehme

155mm  
E-119-47

### STEAMER NET RICHTER

Usually, for steam cleaning, drying with compressed air, tiny dental lab pieces such as crowns, inlays, bridges and metal bits for implantology are held by hand or with crown holding forceps. The new Richter Steamer Net (D.G.B.M.) is created especially for these operations.

### ADVANTAGES

- protection of dental lab pieces during cleaning
- pieces do not get lost or tossed aside
- easy handling, compared to tweezers or crown holding forceps
- modified pressure due to the absorbing and fixing effect of special net covers
- changeable covers

### VAPORIZADOR NETO RICHTER

Por lo general, para la limpieza con vapor, secado con aire comprimido, pequeñas piezas de laboratorio dental como coronas, incrustaciones, puentes y metal los bits para implantología se sostienen a mano o con fórceps para sostener la corona. El nuevo Richter Steamer Net (D.G.B.M.) se crea especialmente para estas operaciones.

### VENTAJAS

- protección de piezas de laboratorio dental durante la limpieza
- las piezas no se pierden ni se arrojan a un lado
- fácil manejo, en comparación con pinzas o fórceps para sostener la corona
- presión modificada debido a la efecto de absorción y fijación de cubiertas de red especiales
- fundas intercambiables



RICHTER  
Steamer Net  
VAPORIZADOR NETO  
Rede de vapor  
E-900-02  
Replacement Nets/pair  
Redes de reemplazo / par  
Redes de Substituição / par  
E-900-02A

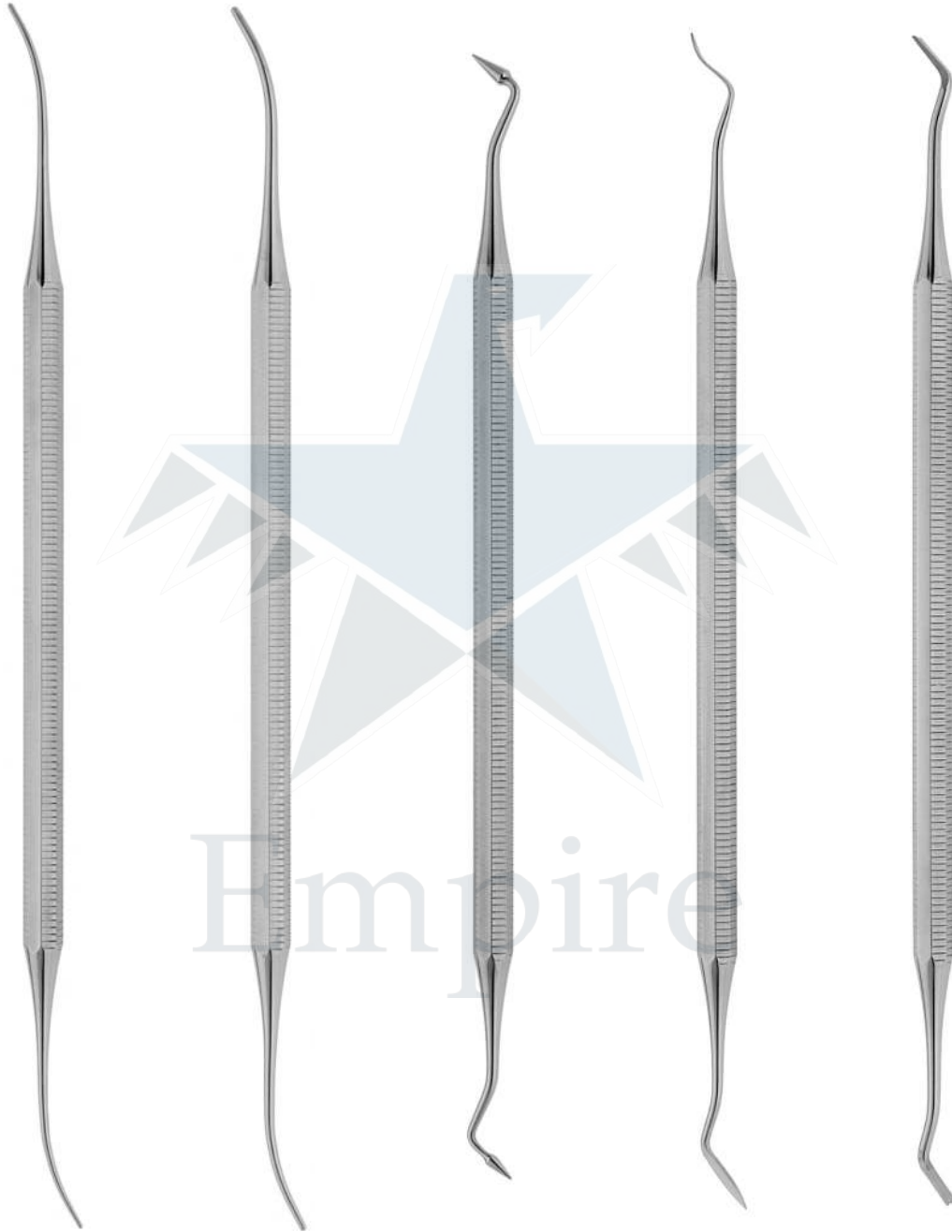

E-165-01 ●  
E-165-01R ●

E-165-02 ●  
E-165-02R ●

E-165-03 ●  
E-165-03R ●

E-165-04 ●  
E-165-04R ●

E-165-05 ●  
E-165-05R ●

» also available as Set  
» también disponible como conjunto  
» Também disponível como Set

» Fig. 1-5 ● E-165-S  
● E-165-SR

Octagonal handle  
Mango octogonal  
Ø 5,5mm



Round handle solid  
Manija redonda sólida  
Ø 6mm





# THOMAS



- » also available as Set
- » también disponible como conjunto
- » Também disponível como Set
- » Fig. 1-5 ●E-166-S



HYLIN  
145mm  
E-285-05

HYLIN  
135mm  
E-285-06

HYLIN  
135mm  
E-285-07

GRITMANN  
135mm  
E-285-11

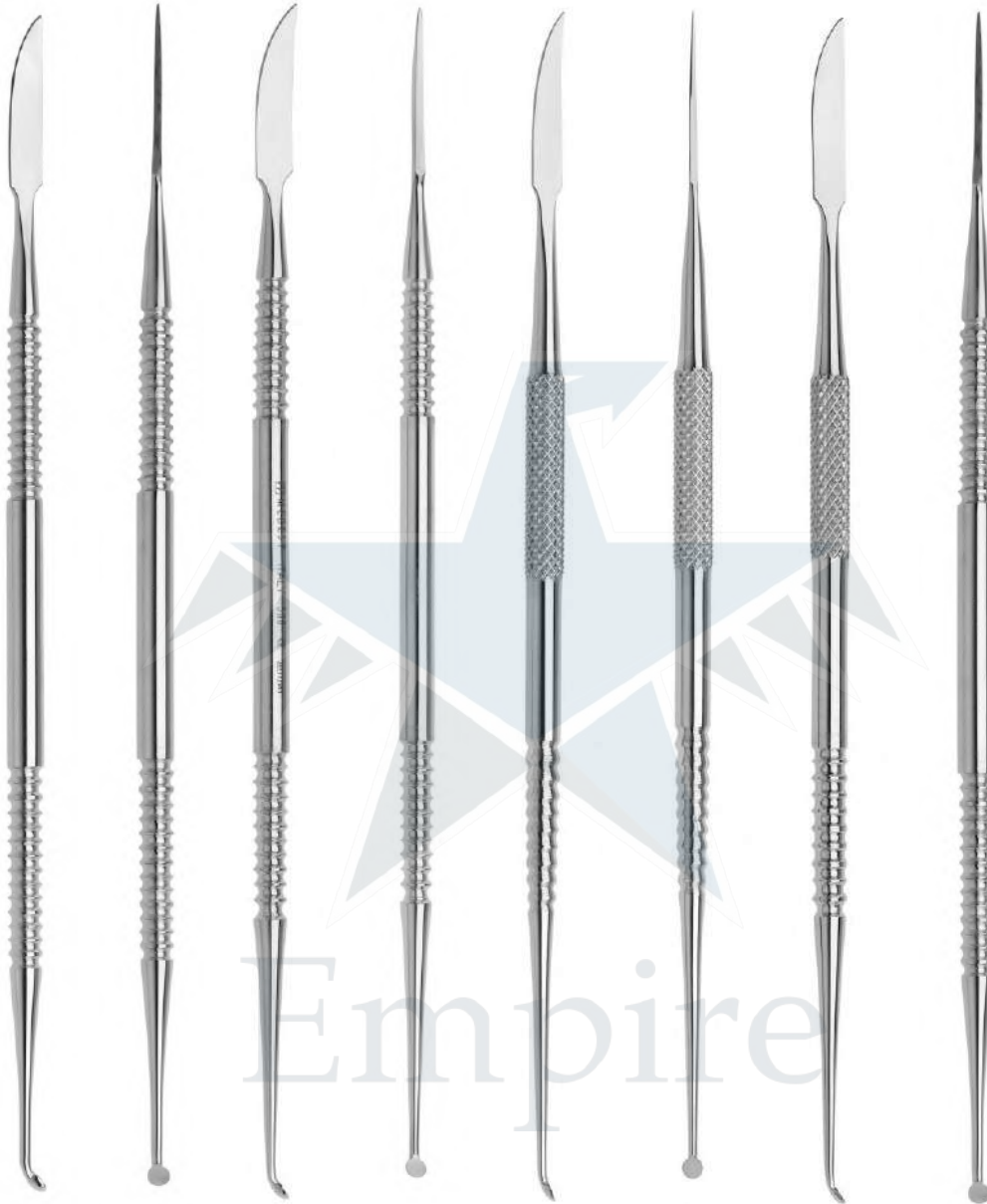

LeCORN  
160mm  
E-285-14

LeCORN  
165mm  
E-285-15

LeCORN  
160mm  
E-285-16

LeCORN  
160mm  
E-285-18

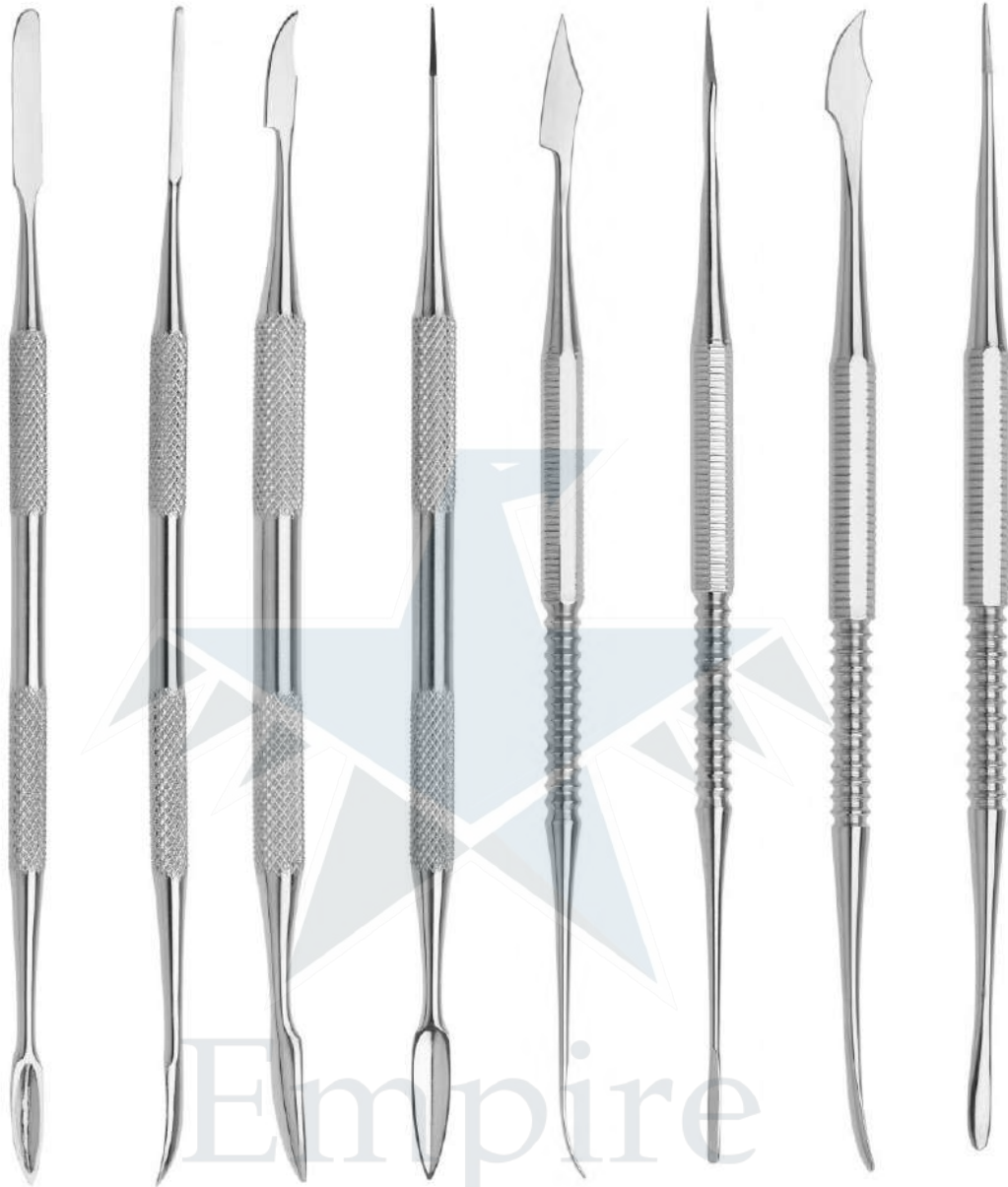

MSY  
155mm  
E-285-24

MSY  
145mm  
E-285-25

ZAHLE  
130mm  
E-285-29

ZAHLE  
120mm  
E-285-30

INSULATED AND  
AUTOCLAVABLE  
AISLAMIENTO Y  
AUTOCLAVABLES  
ISOLADO E AUTOCLÁVEL

WAX AND MODELING INSTRUMENTS  
INSTRUMENTOS DE CERA Y MODELADO



N.1  
E-280-11



N.2  
E-280-12



N.3  
E-280-13



N.4  
E-280-14



N.5  
E-280-15





E-282-22



-23



-24

flexible tip, 0.2mm  
punta flexible, 0.2mm  
dica flexível, 0.2mm



E-282-32



-33



-34

superflexible tip, 0.1mm  
punta superflexible, 0.1mm  
ponta superflexível, 0.1mm



aluminium, blue  
aluminio, azul  
alumínio, azul  
E-282-07

double ended  
doble punta  
duplo fim  
8 mm

E-282-08



aluminium, red  
aluminio, rojo  
alumínio, vermelho  
E-282-09

double ended  
doble punta  
duplo fim  
8 mm

E-282-10



aluminium, yellow  
aluminio, amarillo  
alumínio, amarelo  
E-282-11

double ended  
doble punta  
duplo fim  
8 mm

E-282-12





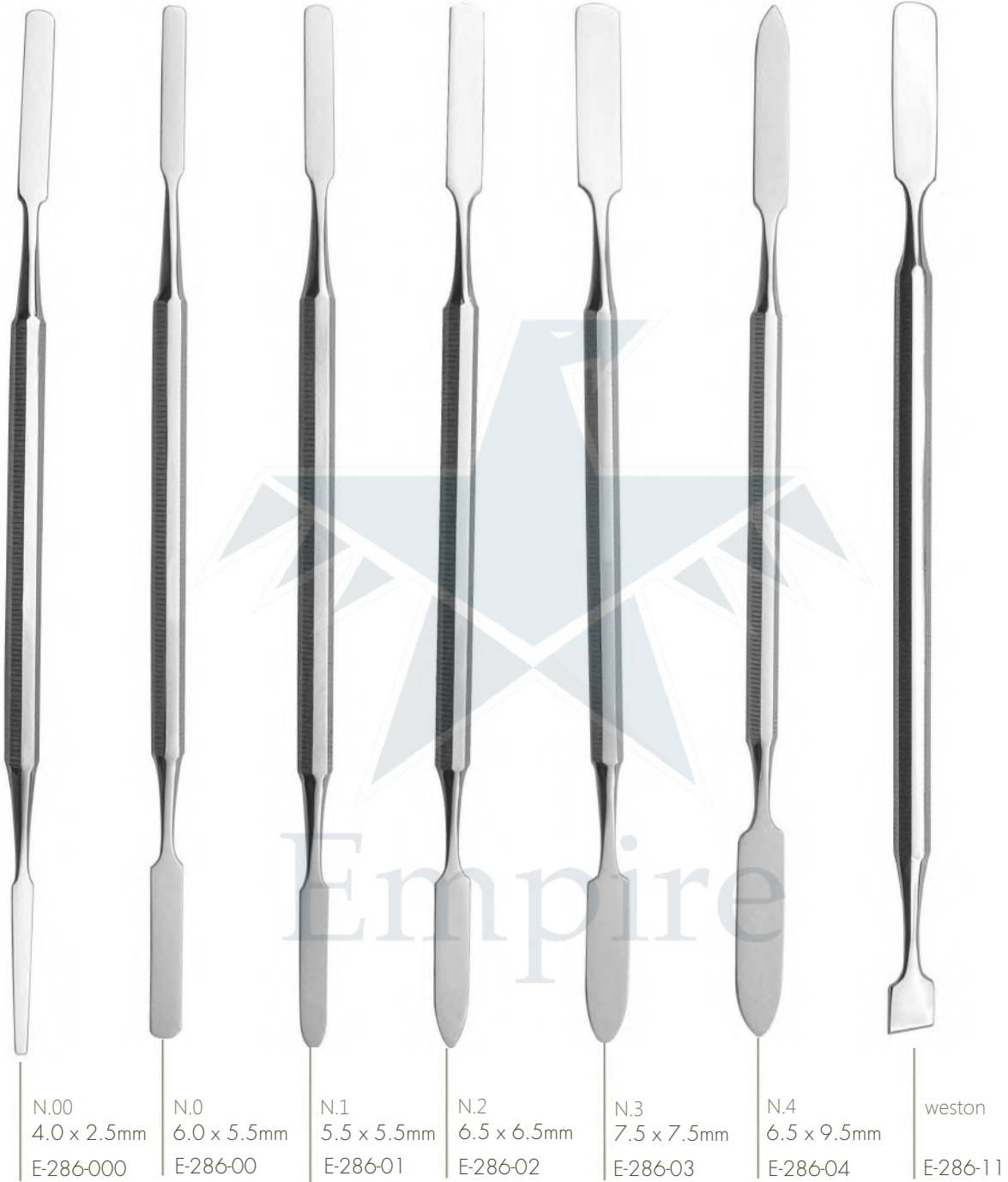



spatula cement flexible  
espátula cemento flexible  
cimento espátula flexível

E-286-25



spatula cement N.24  
espátula cemento N.24  
cimento espátula N.24

E-286-23



spatula cement thin  
espátula cemento delgado  
espátula cemento fino

E-286-22



light pattern N.1  
patrón de luz N.1  
padrão de luz N.1

195 mm  
E-286-19



light pattern N.17  
patrón de luz N.17  
padrão de luz N.17

220 mm  
E-286-17

- ENDODONTICS
- ENDODONCIA
- ENDODONTIA



EMPIRE SURGICAL LTD (THE FUTURE OF HEALTHCARE)



ivory  
E-320-28



ivory  
E-320-27



ivory  
mm5, 6, 7  
E-320-24

Fig. 2



Matrix Band  
Banda de matriz  
Banda Matriz  
E-320-003

Fig. 13



Matrix Band  
Banda de matriz  
Banda Matriz  
E-320-004

Fig. 3



Matrix Band  
Matrizenband  
Banda Matriz  
E-320-002

Fig. 1



Matrix Band  
Matrizenband  
Banda Matriz  
E-320-001



ivory  
37 x 67mm  
E-322-03



elliot  
47 x 43mm  
E-322-06

SEPERATORS SEPARADORES



siqueland, wide  
siqueland, ancho  
siqueland, largo  
E-320-02



siqueland, narrow  
siqueland, estrecho  
siqueland, limitar  
E-320-03



nystrom, left  
nystrom, izquierda  
nystrom, limitar  
E-320-09



nystrom, right  
nystrom, derecha  
nystrom, limitar  
E-320-10



tofflemire  
Senior/Mayor/Senior  
E-320-11



tofflemire  
junior/Junior /júnior  
E-320-12



didner  
8P  
E-320-15



universal  
mm 5, 6, 7  
E-320-18

#### WHAT YOU SHOULD KNOW:

Most dental instruments are made of corrosion-resistant high-grade steels. The requirements for the different grades of steel are defined in national and international standards. They are adapted to meet the special functional properties and conditions of use. Good elasticity, high tensile strength and good corrosion resistance are required for non-cutting instruments such as tooth extracting forceps or tweezers. Cutting instruments such as scissors or scalpels mainly require a high degree of hardness and resistance to wear and corrosion.

If users are asked what they understand by the terms "stainless steel" or "corrosion-resistant high-grade steel", they often assume that so-called stainless steel materials are physically indestructible materials that have high chemical resistance. Many users are surprised to hear or find out that even stainless steel can be susceptible to various types of mechanical, thermal or chemical attack. The corrosion-resistance of stainless steel materials is based on their alloy structure, which forms passivated surface layers that in turn protect the steel.

However, external influences can destroy these protective layers and cause severe damage to the instruments. It is therefore extremely important to preserve the passivated layers on the instruments by appropriate reprocessing methods.

## INSTRUMENT MAINTENANCE AND PREPARATION MANTENIMIENTO Y PREPARACION DE INSTRUMENTOS

#### LO QUE DEBERÍAS SABER:

La mayoría de los instrumentos dentales están hechos de corro-aceros de alta calidad resistentes a la corrosión. Ahí - requisitos para los diferentes grados de acero se definen en estándares nacionales e internacionales Dards. Están adaptados para cumplir con el especial propiedades funcionales y condiciones de uso. Buena elasticidad, alta resistencia a la tracción y Se requiere buena resistencia a la corrosión para instrumentos sin corte tales como extracción de dientes pinzas o pinzas. Instrumentos de corte tales como tijeras o escalpelos requieren principalmente un alto grado de dureza y resistencia adesgaste y corrosión und Korrosion. Si a los usuarios se les pregunta qué entienden por the terms "stainless steel" or "corrosion-resistant high-grade steel ", a menudo asumen que los llamados materiales de acero inoxidable son materiales indestructibles que tienen alto resistencia química. Muchos usuarios están sorprendidos Sed escuchar o descubrir que incluso inoxidable el acero puede ser susceptible a varios tipos de ataque mecánico, térmico o químico. los resistencia a la corrosión de materiales de acero inoxidable se basa en su estructura de aleación, que forma capas superficiales pasivadas que a su vez protegen el acero. Sin embargo, las influencias externas pueden destruir estas capas protectoras y causan severos daño a los instrumentos. Por lo tanto es extremadamente importante para preservar la pasiva-capas en los instrumentos por medio de métodos de reprocesamiento





1/4

E-316-04  
Bicuspid  
Bicúspides  
Bicúspides



1/4

E-316-05  
Bicuspid  
Bicuspid  
Bicúspides



1/4

E-316-07  
Molars  
Molares  
Molares



1/4

E-316-06  
Bicuspid  
Bicuspid  
Bicúspides



1/4

E-316-09  
Molars, Lower  
Molares, inferior  
Molares, baixar



1/4

E-316-08  
Molars  
Molares  
Molares



1/4

E-316-10  
Molars, Left  
Molares, izquierda  
Molares, esquerda



1/4

E-316-11  
Molars, Right  
Molares, derecha  
Molares, certo

# RUBBER DAM CLAMPS

# GOMA DAM CLAMPS

Empire



Empire



AINSWORTH, 17cm  
Rubberdam Punch  
Punzón de goma  
soco de borracha da represa  
E-315-01



IVORY, 16cm  
Rubberdam Punch  
Punzón de goma  
soco de borracha da represa  
E-315-02



STOKE, 17cm  
Rubberdam Clamp Forceps  
Pinzas de sujeción de presa de goma  
Borracha Dam Braçadeira Fórceps  
E-315-03



IVORY, 17cm  
Rubberdam Clamp Forceps  
Pinzas de sujeción de presa de goma  
Borracha Dam Braçadeira Fórceps  
da represa  
E-315-04



BREWSTER, 17cm  
Rubberdam Clamp Forceps  
Pinzas de sujeción de presa de goma  
Borracha Dam Braçadeira Fórceps  
da represa  
E-315-05



plier for clamps and dantalastics, 15cm  
alicates para pinzas y dantalásticos, 15cm  
alicate para grampos e dantálticos, 15cm  
E-315-06



bracket tweezer  
pinza de soporte  
pinça de suporte  
[ 140mm  
E-317-07



bracket tweezer  
pinza de soporte  
pinça de suporte  
[ 140mm  
E-317-08



bracket tweezer  
pinza de soporte  
pinça de suporte  
[ 140mm  
E-317-10



bracket tweezer  
pinza de soporte  
pinça de suporte  
[ 140mm  
E-317-13



bracket tweezer  
pinza de soporte  
pinça de suporte  
[ 120mm  
E-317-16



bracket tweezer  
pinza de soporte  
pinça de suporte  
[ 140mm  
E-317-17



height gauge slot 018  
ranura de medidor de altura 018  
slot de calibre alto 018  
[ 130mm  
E-318-18



height gauge slot 018  
aluminium  
ranura para medidor de altura 018, aluminio  
slot de calibre alto 018  
aluminio  
[ 140mm  
E-318-20



height gauge slot 022  
ranura de medidor de altura 018  
slot de calibre alto 022  
[ 140mm  
E-318-22



height gauge slot 022  
aluminium  
ranura para medidor de altura 018, aluminio  
slot de calibre alto 022  
aluminio  
[ 140mm  
E-318-24



positioning gauge bracket  
posicionamiento del soporte del indicador  
posicionando o soporte de calibre  
[ 65 x 65mm  
E-318-50



positioner brackets  
soportes de posicionadores  
Soportes posicionadores  
[ 165mm  
E-318-44

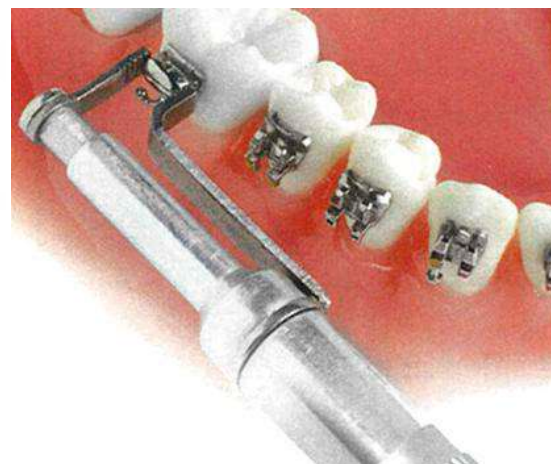



N.0  
ligature director  
ligature director  
diretor de ligadura  
[ 10mm  
E-319-00



tucker N.1  
ligature director  
director de ligadura  
diretor de ligadura  
[ 10mm  
E-319-04



tucker N.1  
ligature director  
director de ligadura  
diretor de ligadura  
[ 10mm  
E-319-07



Utility  
band pusher/ scaler  
empujador de banda / escalador  
empurrador / escalador de banda  
[ 10mm  
E-319-12



band pusher / scaler  
empujador de banda / escalador  
impulsor de banda / scaler  
[ 10mm  
E-319-14

elastic ligature applicator  
aplicador de ligadura elástica  
aplicador elástico de ligadura  
[ 10mm  
E-319-18





band pusher, mershon  
empujador de banda, mershon  
empurrador de banda, mershon  
[ 150mm  
E-321-23



molar band seater  
espaciador de banda molar  
assento de banda molar  
[ 140mm  
E-321-28



band pusher, teflon handle  
empujador de banda, mango de teflón  
empurrador de banda,  
alça de teflon  
[ 145mm  
E-321-36



ENDO EXCAVATORS  
EXCAVADORAS ENDO

ENDODONTIC TWEEZERS  
PINZAS ENDODONTICAS

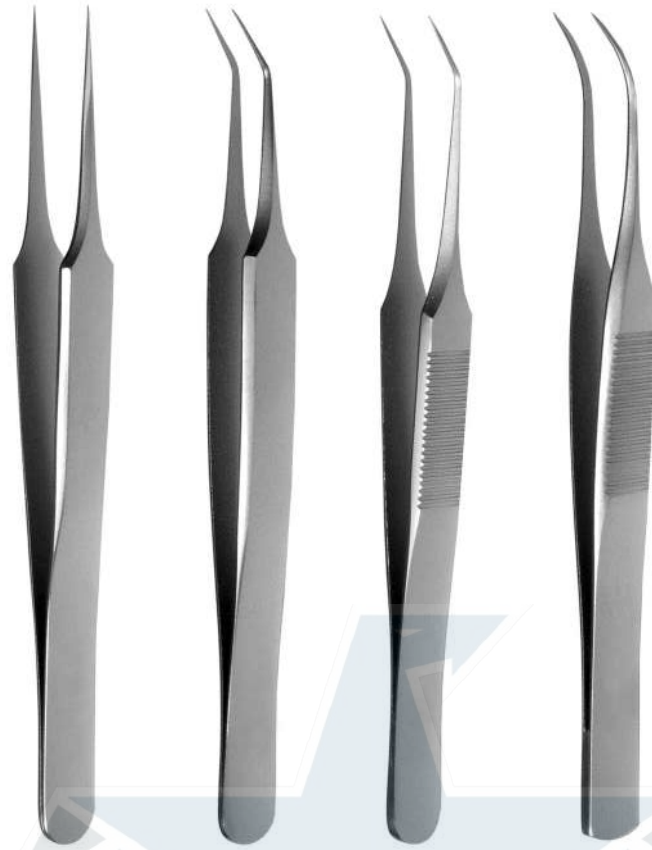

[ 110mm  
E-184-41

[ 110mm  
E-184-42

[ 110mm  
E-184-43

[ 110mm  
E-184-44

- » very fine tips
- » consejos muy finos
- » dicas muito finas

1,0

1,5

2,0

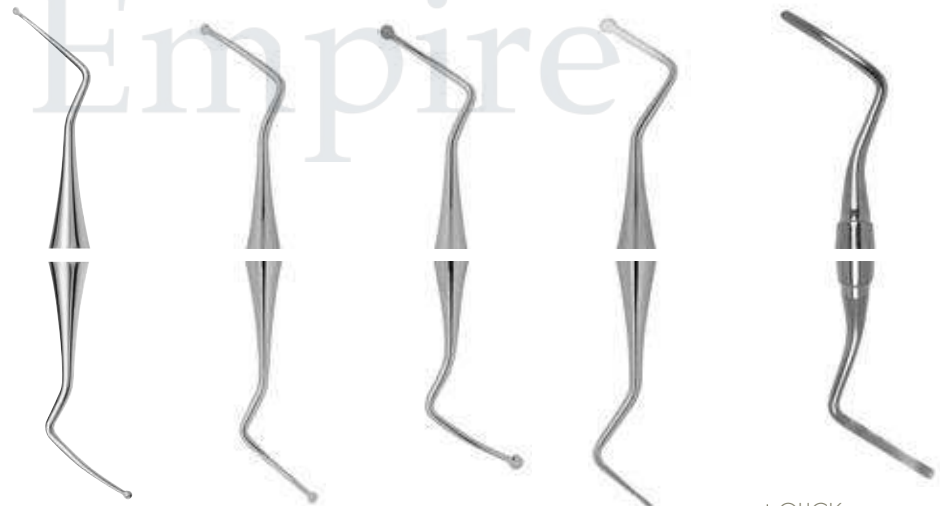

E-134-31L ●  
E-135-31L ●

E-134-32L ●  
E-135-32L ●

E-134-33L ●  
E-135-33L ●

E-135-PT55 ●

GLICK  
E-134-GL2 ●  
E-135-GL2 ●

Octagonal handle  
Mango octogonal  
Ø 5,5mm



Round handle solid  
Manija redonda sólida  
Ø 6mm





Endodontic Forceps  
Pinzas endodónticas  
pinça endodôntica  
E-610-05

Suture Tweezers  
Pinzas de sutura  
Pinça de sutura  
15cm  
E-181-04

Endo Locking  
Tweezers  
Endo Locking  
Pinzas  
Pinça de  
travamento Endo  
15cm  
E-180-68

THYMOZIN  
Applicator  
Aplicador  
Aplicador  
E-118-01

THYMOZIN  
Applicator  
Aplicador  
Aplicador  
E-118-02

BUCHANAN  
Plugger  
Plugger  
plugger  
0,7mm  
E-118-B1  
1,0mm  
E-118-B2



GLICK ENDO  
 Plugger/Spatula  
 plugger / espátula  
 Plugger / Espátula  
 E-118-GL1

DG16  
 Spreader  
 esparcidor  
 Propagador  
 E-101-16

DG16  
 Spreader  
 esparcidor  
 Propagador  
 E-101-16B

Spreader  
 esparcidor  
 Propagador  
 E-108-D11T

Plugger  
 Plugger  
 plugger  
 E-108-01/03

Plugger  
 Plugger  
 plugger  
 E-108-05/07

Plugger  
 Plugger  
 plugger  
 E-108-09/11

NEW NUEVO

The special chromium coating significantly hardens the stainless steel to improve sharpness and strength while maintaining tactile feedback

El cromo especial recubrimiento de manera significativa endurece el acero inoxidable fuerza mientras mantiene retroalimentación táctil



Spreader  
esparcidor  
Espalhador  
E-118-S20



E-118-S30



E-118-S40



E-118-S50



Plugger  
Plugger  
plugger  
118/P60



E-118-P80



E-118-P100



E-118-P120

ENDODONTIC EXPLORERS



FIG. 1  
E-128-01



FIG. DG16  
E-128-16

ENDODONTIC EXCAVATORS



FIG. 1  
E-129-01



FIG. 2  
E-129-02

HAND SPREADERS

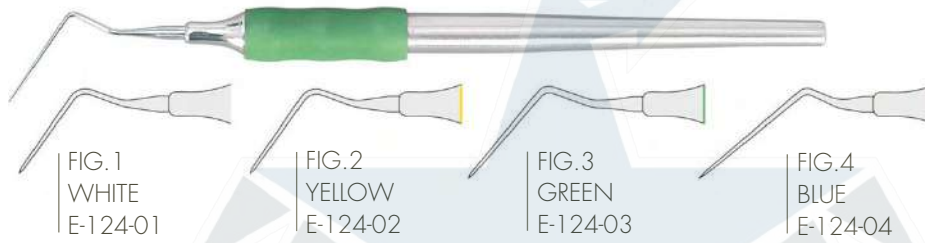

FIG. 1  
WHITE  
E-124-01

FIG. 2  
YELLOW  
E-124-02

FIG. 3  
GREEN  
E-124-03

FIG. 4  
BLUE  
E-124-04

HAND PLUGGERS

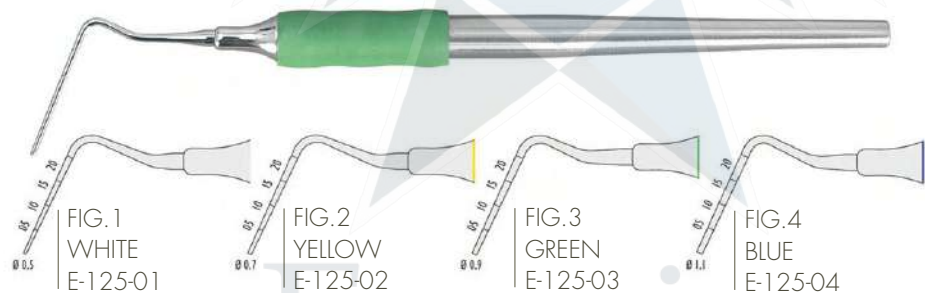

FIG. 1  
WHITE  
E-125-01

FIG. 2  
YELLOW  
E-125-02

FIG. 3  
GREEN  
E-125-03

FIG. 4  
BLUE  
E-125-04

ENDODONTIC RETRACTORS



FIG. 1  
BLUE  
E-126-01

FIG. 2  
RED  
E-126-02

FIG. 3  
GREEN  
E-126-03

SOFT LINE / MAX GRIP INSTRUMENTS  
INSTRUMENTOS SOFT LINE / MAX GRIP





ENDO BOX  
 Plugger/Spatula  
 plugger / espátula  
 Plugger / Espátula  
 E-118-22  
 104 X 44 X 5mm



ENDO BOX  
 Plugger/Spatula  
 plugger / espátula  
 Plugger / Espátula  
 E-118-23  
 104 X 44 X 5mm



ENDO BOX  
 Plugger/Spatula  
 plugger / espátula  
 Plugger / Espátula  
 E-118-24  
 104 X 44 X 5mm



ENDO BOX  
 Plugger/Spatula  
 plugger / espátula  
 Plugger / Espátula  
 E-118-25  
 104 X 44 X 5mm



ENDO BOX  
 Plugger/Spatula  
 plugger / espátula  
 Plugger / Espátula  
 E-118-26  
 104 X 44 X 5mm



ENDO BOX  
 Plugger/Spatula  
 plugger / espátula  
 Plugger / Espátula  
 E-118-27  
 104 X 44 X 5mm



ENDODONTIC BOX, LARGE  
 Plugger/Spatula  
 plugger / espátula  
 Plugger / Espátula  
 E-118-32  
 204 X 105 X 54mm



ENDODONTIC BOX, LARGE  
 Plugger/Spatula  
 plugger / espátula  
 Plugger / Espátula  
 E-118-33  
 204 X 105 X 54mm





ENDODONTIC BOX, LARGE  
Plugger/Spatula  
plugger / espátula  
Plugger / Espátula  
E-118-34  
204 X 105 X 54mm



ENDODONTIC BOX, LARGE  
Plugger/Spatula  
plugger / espátula  
Plugger / Espátula  
E-118-35  
204 X 105 X 54mm



ENDODONTIC BOX, MEDIUM  
Plugger/Spatula  
plugger / espátula  
Plugger / Espátula  
E-118-36  
125 X 105 X 54mm

ENDODONTIC TRAY  
Plugger/Spatula  
plugger / espátula  
Plugger / Espátula  
E-118-37  
257 X 116 X 16mm



# ENDO BASIC SET

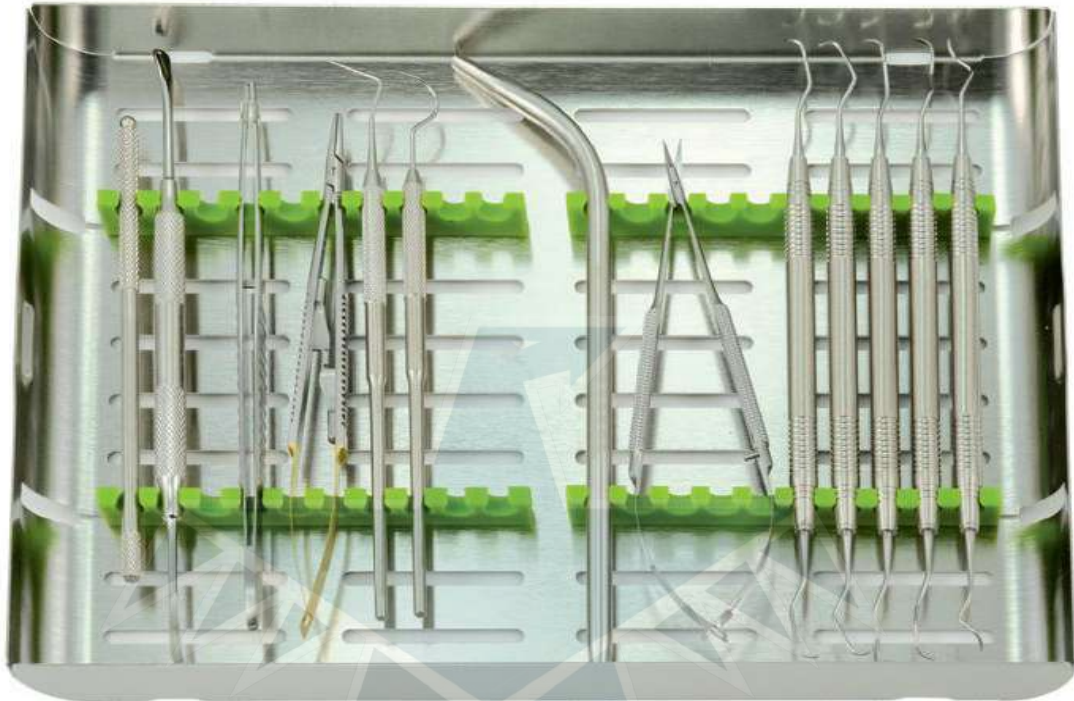

## ENDO BASIC SET

E-101-16	Endontic explorer DG16
E-200-51M	Mirror Handle with measuring scale
E-184-44	Endodontic tweezer
E-134-31L	Endo Spoon (Excavator) #31L
E-180-68	London College Tweezers with lock
E-134-GL2	Excavator GL2
E-108-D11T	Endo Spreader D11T
E-108-01/03	Root Canal Plugger 1-3
E-108-05/07	Root Canal Plugger 5-7
E-108-09/11	Root Canal Plugger 9-11
E-610-04A	Stieglitz Root Splinter Forceps curved
E-242-03	Dean Gum Scissors 17cm serrated
E-500-03	Clip Wash Tray with Silicon Inserts 288 x 187 x 25mm

## ENDO BASIC SET

Explorador de endodoncia DG16
Mirror Handle con escala de medición
Pinza de endodoncia
Endo Spoon (Excavadora) # 31L
London College Pinzas con cerradura
Excavadora GL2
Endo Spreader D11T
Enchufe del canal de la raíz 1-3
Enchufe del canal de la raíz 5-7
Enchufe del canal de la raíz 9-11
Stieglitz Root Splinter Forceps curvo
Dean Gum Scissors 17cm serrado
Clip Wash Tray with Silicone Inserts 288 x 187 x 25mm

# PERIODONTAL PERIODONTICS



EMPIRE SURGICAL LTD (THE FUTURE OF HEALTHCARE)

# PERIO SURGICAL SET

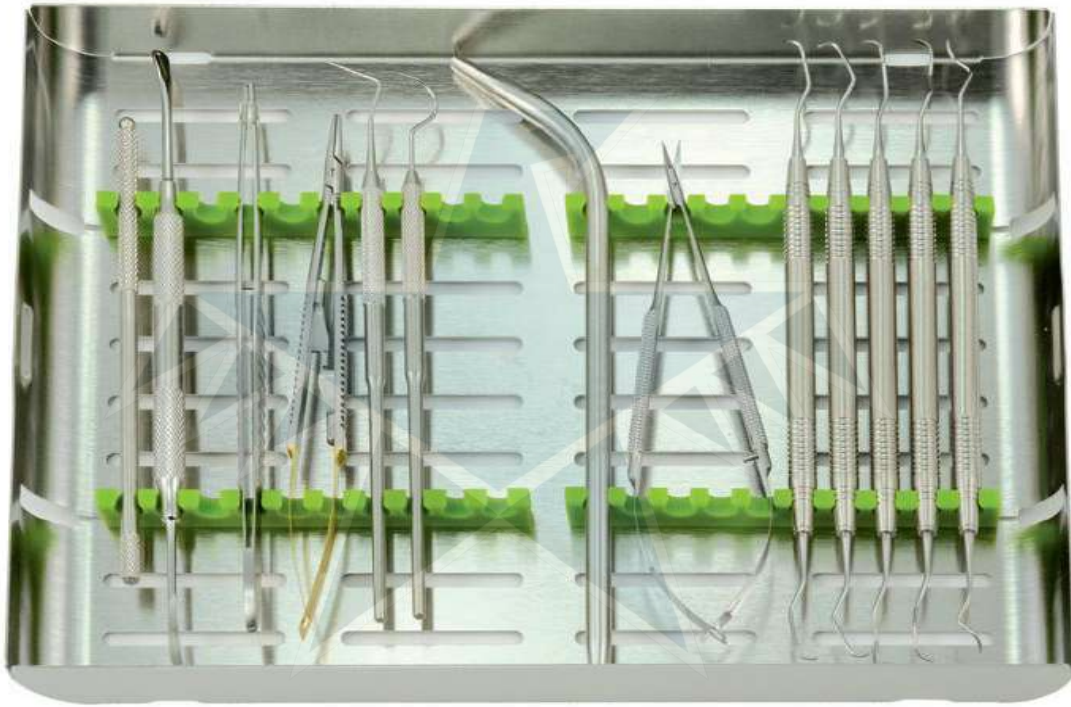

## PERIO SURGICAL SET

## JUEGO QUIRURGICO PERIO

E-185-08MK	Scalpel handle 13cm for mini blades	Mango de bisturí 13cm para mini cuchillas
E-195-02	Suction Tube acidproof 3mm / 18cm	Tubo de succión ácido 3mm / 18cm
E-335-GF14	Goldman-Fox Raspatories GF14	Raspatories Goldman-Fox GF14
E-183-02	Gillies Tissue Forceps 15cm	Gillies Tissue Forceps 15cm
E-251-33	Micro-Scissors 15cm curved	Micro-Tijeras 15cm curvadas
E-174-55TC	Castroviejo Needle Holder 14cm TC straight	Castroviejo Nadelhalter 14cm TC gerade
E-405-W	Williams Perio-Probe	Williams Perio-Sonde
E-400-05/06ED	Gracey Curette 5-6, lingual - buccal	Gracey Kürette 5-6, lingual - bukkal
E-400-07/08ED	Gracey Curette 7-8, lingual - buccal	Gracey Kürette 7-8, lingual - bukkal
E-400-11/12ED	Gracey Curette 11-12, mesial	Gracey Kürette 11-12, mesial
E-400-13/14ED	Gracey Curette 13-14, distal	Gracey Kürette 13-14, distal
E-401-204S/ED	Universal Scaler 204S	Universal Scaler 204S
E-101-23	Explorer e.e. Fig. 23	Sonde e.e. Fig. 23
E-500-03	Wash Tray with Silicon Inserts 288 x 187 x 25mm	Lavado de la bandeja con incrustación de silicio 288 x 187 x 25mm



# PERIO CLASSIC SET



## PERIO CLASSIC SET

## JUEGO PERIO CLASSIC

E-400-05/06ED	Gracey Curette 5-6, lingual - buccal	Gracey Curette 5-6, lingual - bukkal
E-400-07/08ED	Gracey Curette 7-8, lingual - buccal	Gracey Curette 7-8, lingual - bukkal
E-400-11/12ED	Gracey Curette 11-12, mesial	Gracey Curette 11-12, mesial
E-400-13-14ED	Gracey Curette 13-14, distal	Gracey Curette 13-14, distal
E-200-51	Mirror Handle	Mango espejo
E-401-204SD/ED	Universal Scaler 204SD	Universal Scaler 204SD
E-401-H6/H7/ED	Universal Scaler H6-H7	Universal Scaler H6-H7
E-180-09	Meriam Tooth Tweezers	Pinzas para los dientes Meriam
E-405-CP15	Perio Probe CP15	Parosonde CP15
E-500-T	Wash Tray with Silicon Inlay 185 x 145 x 30mm	Lavado de la bandeja con incrustación de silicio 185 x 145 x 30mm

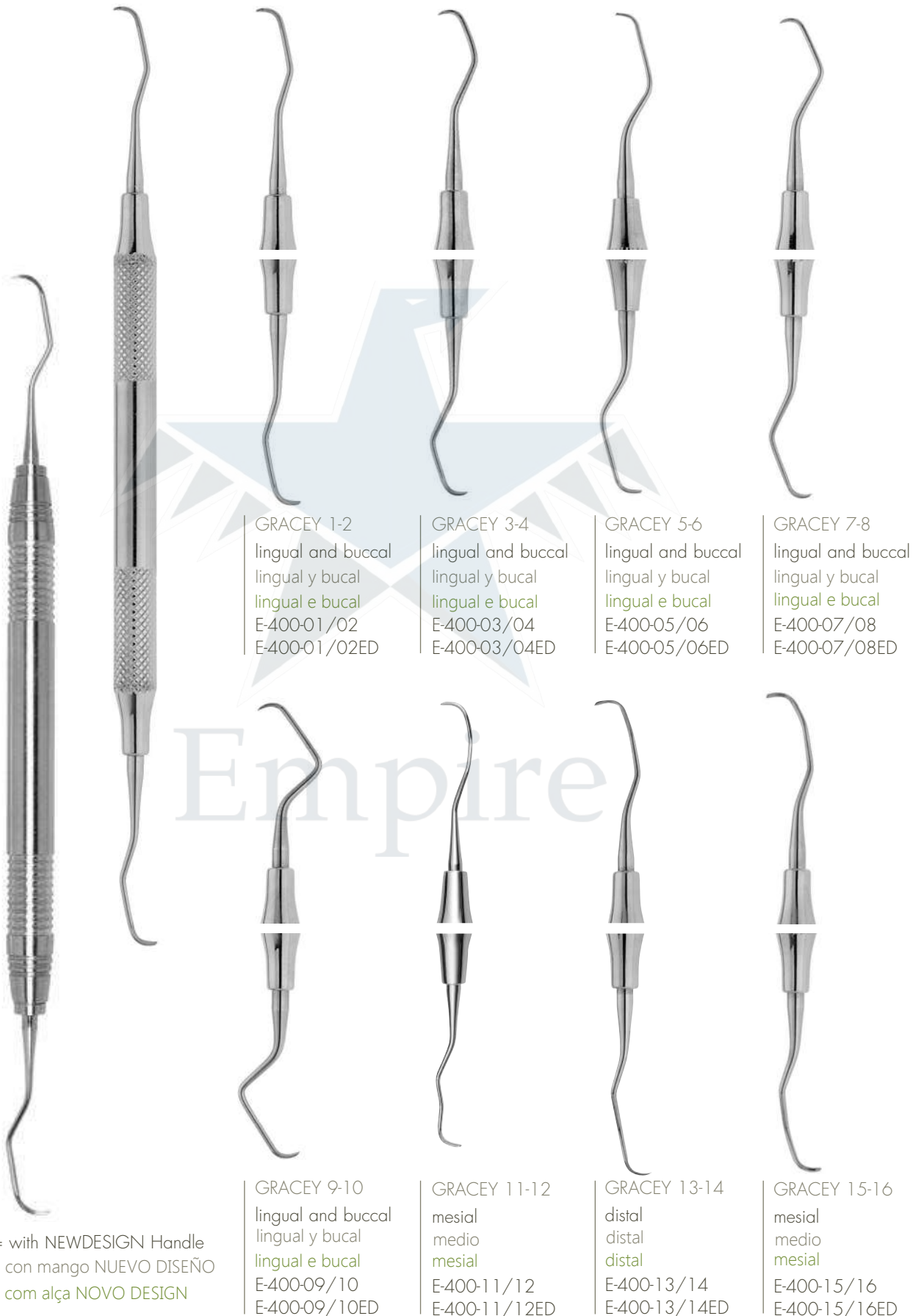

GRACEY 1-2  
lingual and buccal  
lingual y bucal  
lingual e bucal  
E-400-01/02  
E-400-01/02ED

GRACEY 3-4  
lingual and buccal  
lingual y bucal  
lingual e bucal  
E-400-03/04  
E-400-03/04ED

GRACEY 5-6  
lingual and buccal  
lingual y bucal  
lingual e bucal  
E-400-05/06  
E-400-05/06ED

GRACEY 7-8  
lingual and buccal  
lingual y bucal  
lingual e bucal  
E-400-07/08  
E-400-07/08ED

GRACEY 9-10  
lingual and buccal  
lingual y bucal  
lingual e bucal  
E-400-09/10  
E-400-09/10ED

GRACEY 11-12  
mesial  
medio  
mesial  
E-400-11/12  
E-400-11/12ED

GRACEY 13-14  
distal  
distal  
distal  
E-400-13/14  
E-400-13/14ED

GRACEY 15-16  
mesial  
medio  
mesial  
E-400-15/16  
E-400-15/16ED

ND = with NEWDESIGN Handle  
ND = con mango NUEVO DISEÑO  
ND = com alça NOVO DESIGN



DEEP SCALE GRACEYS

NEW: Deep Scale Graceys, especially for the use in deep, narrow pockets and for root planing. On these special curettes, the 1st shaft is 3mm longer and the scaling tip is 50% shorter than regular Graceys.

ESCALA PROFUNDA DE GRACEY

NUEVO: Graceys de escala profunda, especialmente para el uso en profundidad, NUEVO: Graceys de escala profunda, especialmente para el uso en profundidad, es 3 mm más largo y la punta de escala es 50% más corta que Graceys regular.

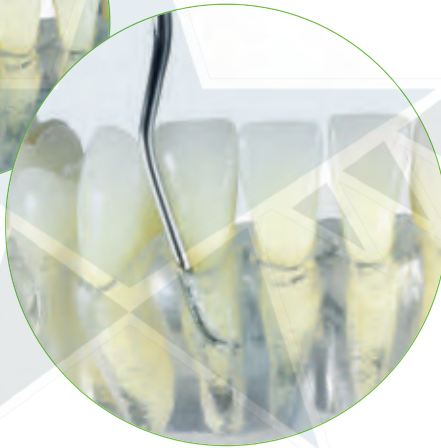

GRACEY 1-2M  
lingual and buccal  
lingual y bucal  
lingual e bucal  
E-400-01/02M/ED



GRACEY 5-6M  
lingual and buccal  
lingual y bucal  
lingual e bucal  
E-400-05/06M/ED

GRACEY 7-8M  
lingual and buccal  
lingual y bucal  
lingual e bucal  
E-400-07/08M/ED

GRACEY 11-12M  
lingual and buccal  
lingual y bucal  
lingual e bucal  
E-400-11/12M/ED

GRACEY 13-14M  
lingual and buccal  
lingual y bucal  
lingual e bucal  
E-400-13/14M/ED

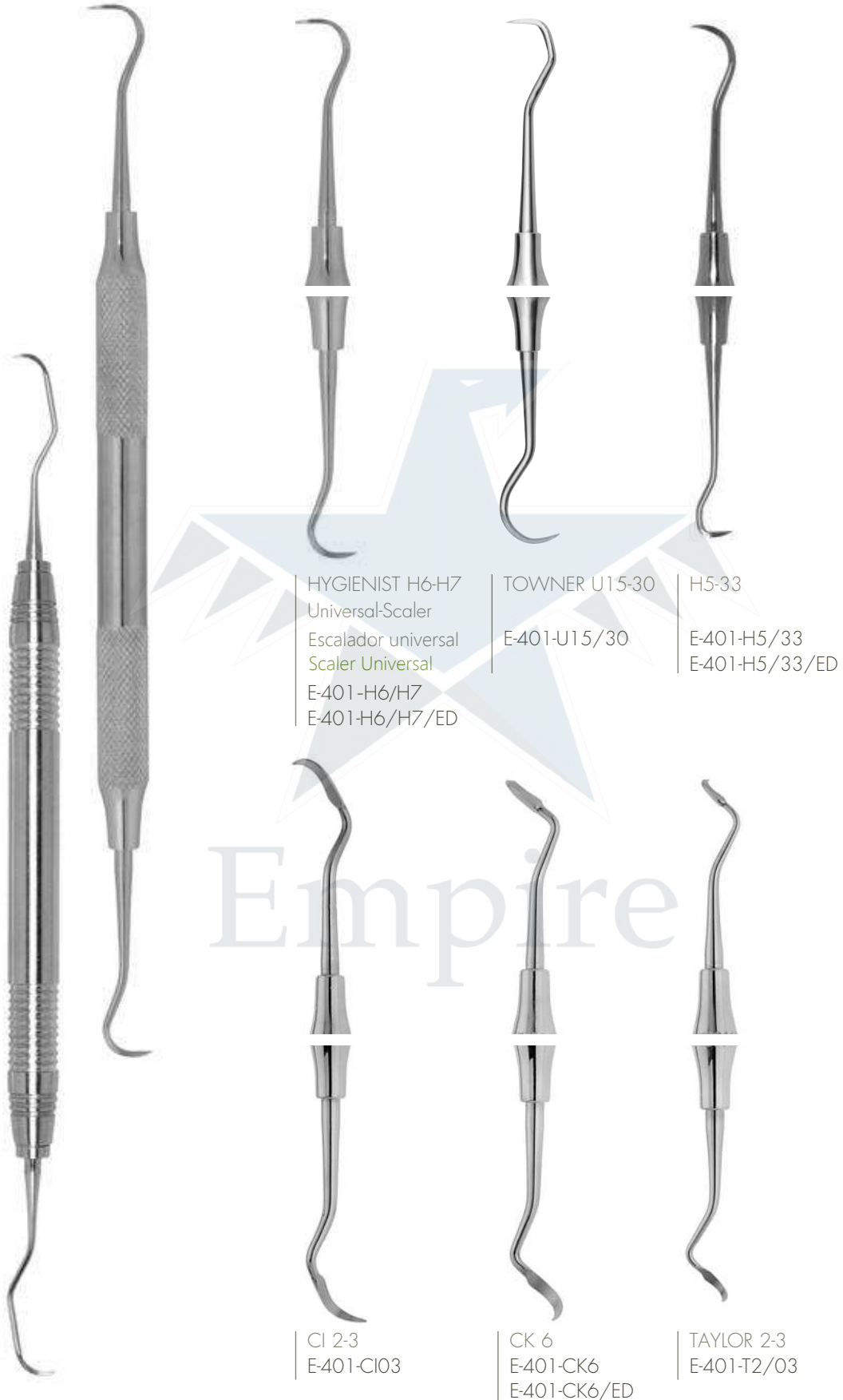

HYGIENIST H6-H7  
Universal-Scaler  
Escalador universal  
Scaler Universal  
E-401-H6/H7  
E-401-H6/H7/ED

TOWNER U15-30  
E-401-U15/30

H5-33  
E-401-H5/33  
E-401-H5/33/ED

CI 2-3  
E-401-CI03

CK 6  
E-401-CK6  
E-401-CK6/ED

TAYLOR 2-3  
E-401-T2/03

ND = NEWDESIGN Handle  
ND = mango NUEVO DISEÑO  
ND = com alça NOVO DESIGN

# SICKLE SCALER ESCALADOR DE ENFERMEDADES



204  
E-401-204  
E-401-204/ED



204 S  
E-401-204S  
E-401-204S/ED



204 SD  
E-401-204SD  
E-401-204SD/ED



COLUMBIA 2RL  
E-401-02RL  
E-401-02RL/ED



COLUMBIA 4RL  
E-401-04RL  
E-401-04RL/ED



COLUMBIA 13-14  
E-401-C13/14  
E-401-C13/14/ED



- » special stainless steel, perfect grinding for long lasting sharpness
- » spezieller superharter Edelstahl, perfekter Schliff für langanhaltende Schärfe

# UNIVERSAL SCALER ESCALADOR UNIVERSAL

PERIODONTICS ESCALADORES / CURETAS

SCALERS / CURETTES PERIODONTICS



Empire



BROWN  
MARRÓN  
CASTANHO  
E-402-11



BLUE  
AZUL  
AZUL  
E-402-12



LIGHT BLUE  
AZUL CLARO  
AZUL CLARO  
E-402-13



SILVER  
PLATA  
PRATA  
E-402-14



YELLOW  
AMARILLO  
AMARELO  
E-402-15



PURPLE  
PÚRPURA  
ROXA  
E-402-16



GREEN  
VERDE  
VERDE  
E-402-17

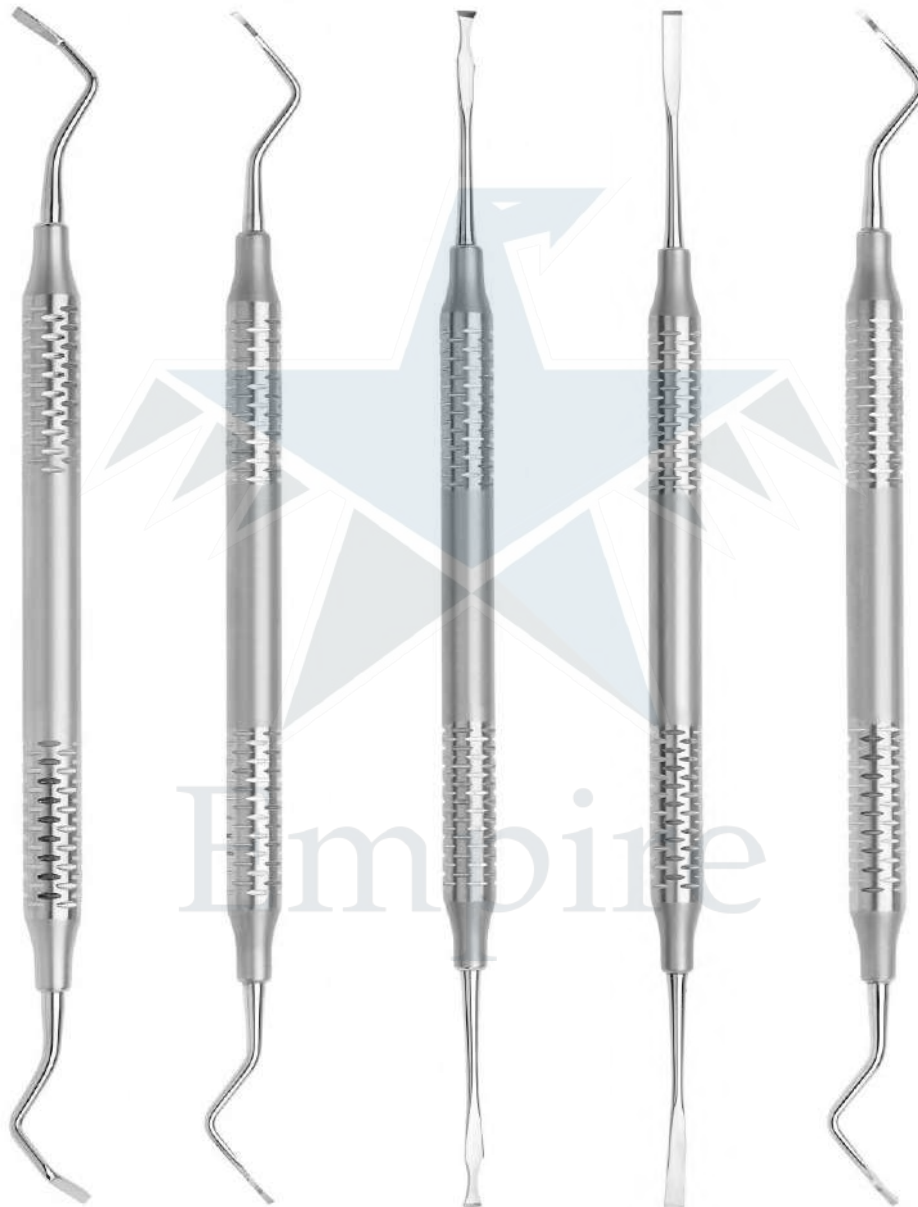

ochsenbein N.3

[ 8mm  
E-317-07

ochsenbein

[ 8mm  
E-317-07

TG-0

[ 8mm  
E-317-07

TG

[ 8mm  
E-317-07

rhodes 36/37

[ 140mm  
E-317-07

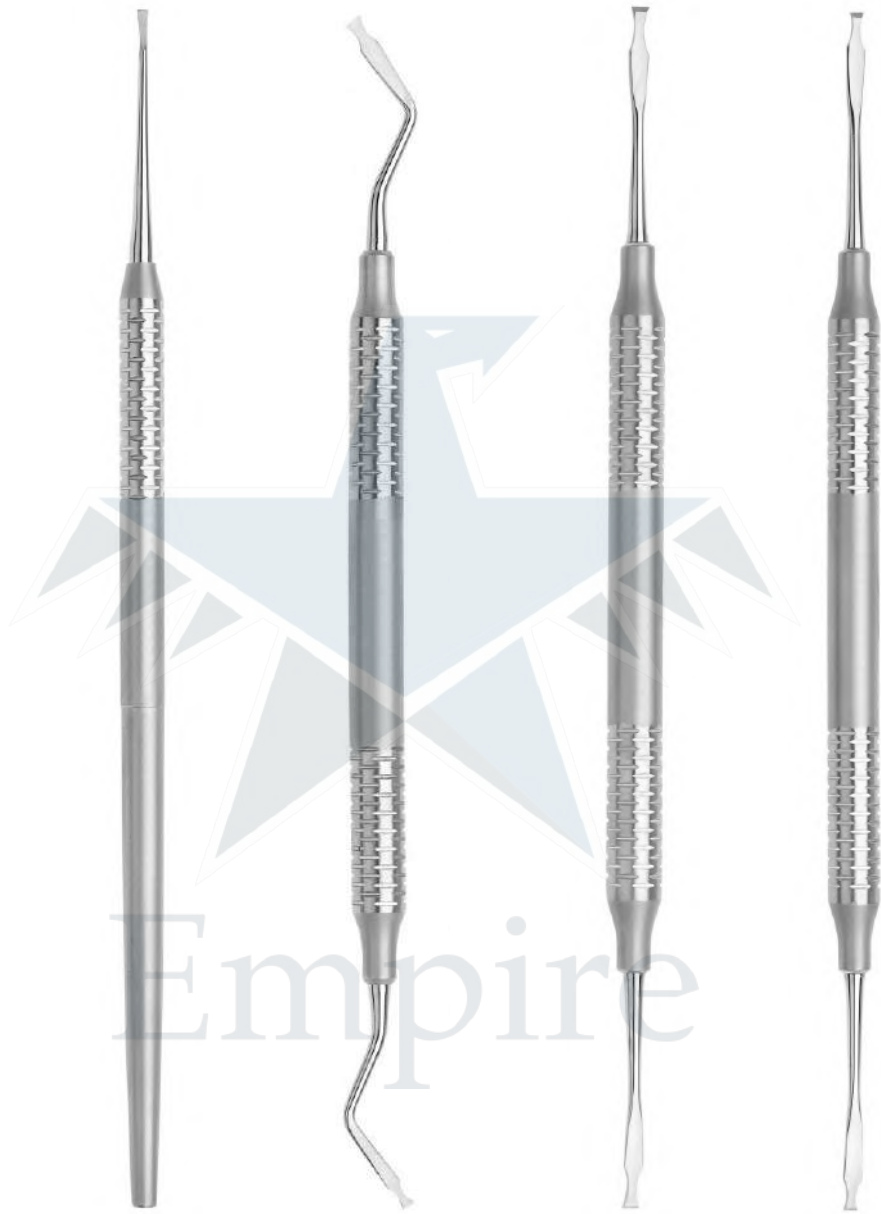

zerfing

[ 6mm  
E-317-07

fedi N.3

[ 140mm  
E-317-07

fedi N.2

[ 8mm  
E-317-07

fedi N.1

[ 8mm  
E-317-07





11

Molt  
E-402-22



11

Molt  
6mm/3mm  
E-402-24



11

Molt  
3mm/2.5mm  
E-402-26



11

Lucas  
E-402-28



11

Lucas  
E-402-01

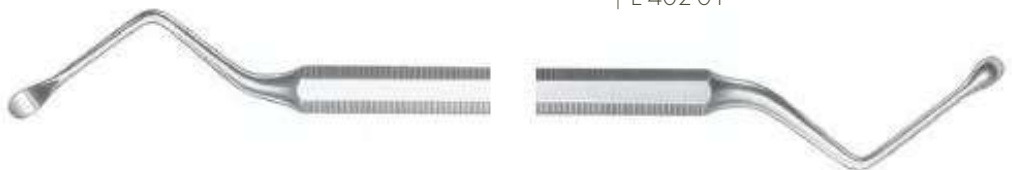

11

Lucas  
E-402-30

PERIODONTICS URETTES ÓSEOS

BONE URETTES PERIODONTICS



volkmann  
N-0000  
E-402-04



volkmann  
N-000  
E-402-03



volkmann  
N-00  
E-402-02



volkmann  
N-0  
E-402-01



volkmann  
N-1  
E-402-00



volkmann  
N-2  
E-402-06



volkmann  
N-3  
E-402-09



YELLOW, AL 1-2

E-404-01/02



RED, AL 3-4

E-404-03/04



WHITE, AL 5-6

E-404-05/06



BLACK, AL 7-8

E-404-07/08



BLUE, AL 9-10

E-404-09/10



GREEN, AL 11-12

E-404-21/22



BROWN, AL 13-14

E-404-21/22



LANGER 1-2  
E-401-L1/02

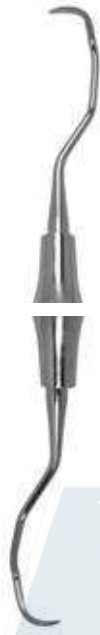

LANGER 3-4  
E-401-L3/04



LANGER 5-6  
E-401-L5/06



INDIANA  
UNIVERSITY  
E-401-U13/14



INDIANA  
UNIVERSITY  
E-401-U17/18

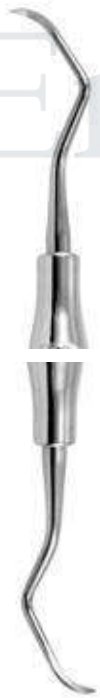

M23  
E-401-M23  
E-401-M23/ED



MCCALL 13-14  
E-401-13/14



MCCALL 13S-14S  
E-401-13S/14S



MCCALL 17S-18S  
E-401-17S/18S

# GOLDMAN-FOX



GF-1  
E-401-GF1



GF-2  
E-401-GF2



GF-3  
E-401-GF3

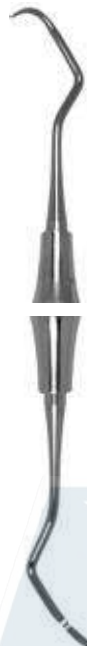

GF-4  
E-401-GF4



GF-5  
E-401-GF5



GF-6  
E-401-GF6



GF-21  
E-401-GF21



MITCHEL  
E-121-M



CUMMINE  
E-121-C

PERIODONTICS

PERIODONTICS

Empire



GOLDMAN-FOX 7  
E-401-KGF7



GOLDMAN-FOX 8  
E-401-KGF8



GOLDMAN-FOX 9  
E-401-KGF9

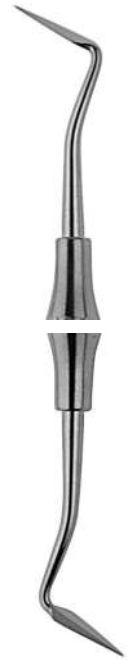

GOLDMAN-FOX 11  
E-401-KGF11

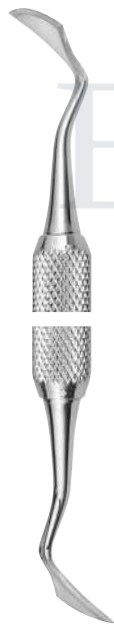

KIRKLAND 15/16  
E-401-K1



ORBAN 1-2  
E-401-KO12



RHODES BACK-ACTION  
E-401-RBA

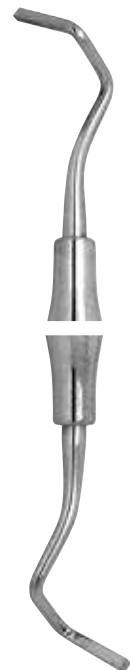

OCHSENBEIN  
E-401-03

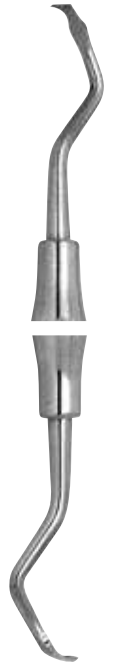

E-401-04



E-335-T1



E-335-T2



# NEW TUNNELING INSTRUMENTS INSTRUMENTOS DE TÚNELES

The tunnelling instruments of Dental are designed for use in microsurgery for the preparation of split- and full thickness flaps for subsequent ridge augmentations and for repairs of gingival defects caused by receding gums. The precisely manufactured working ends enable precise opening of the gingiva and can thus help prevent large flap openings.

Los instrumentos de túnel de Dental son diseñado para su uso en microcirugía para el preparación de espesor dividido y completo aletas para aumentos de cresta posteriores y para reparaciones de defectos gingivales causado por encías retraídas. El pre los extremos de trabajo fabricados con certeza permiten apertura precisa de la encía y puede por lo tanto, ayuda a evitar grandes aberturas de aleta.



HIRSCHFELD 3-7  
E-401-H3/07



HIRSCHFELD 5-11  
E-401-H5/11



SUGARMAN 1S-2S  
E-401-FS12



SUGARMAN 3S-4S  
E-401-FS34



SCHLUGER 9-10S  
E-401-FS910



BUCK 11-12  
E-401-FB1112

Empire



MOLT 9  
E-335-M9  
E-335-M9/ED

24 GSP  
E-335-24GSP  
E-335-24GSP/ED

BUSER  
E-335-B1  
E-335-B1/ED

GOLDMAN FOX 14  
E-335-GF14  
E-335-GF14/ED

PRICHARD PR3S  
E-335-PR3S

MOLT 10  
E-335-M10  
E-335-M10/ED

Empire

# TITANIUM TITANIO

NEWDESIGN Titanium Curettes with extremely light handle and tips made of Titanium especially applicable to clean implants. By using Titanium for the tips, a damage of the surface of the implants will be avoided. The L-Light Titanium Curettes are currently available in 5 different pattern.

NUEVO DISEÑO Curetetas de titanio con mango extremadamente ligero y puntas hechas de Titanio especialmente aplicable para limpiar implantes. Al usar Titanium para los consejos, un daño de la superficie de los implantes será evitado El titanio L-Light Las curetas están actualmente disponibles en 5 patrón diferente

Following pattern also available (no picture):  
El siguiente patrón también está disponible (sin imagen):

COLUMBIA 2RL = E-401-2RL/ED  
COLUMBIA 4RL = E-401-4RL/ED



E-401-204SD/ED  
Universal Scaler 204SD

E-401-H6H7/ED  
Universal Scaler H6/H7

E-401-L1/2/ED  
Langer Kürette Fig. 1-2

E-401-L3/4/ED  
Langer Kürette Fig. 3-4

E-401-L5/6/ED  
Langer Kürette Fig. 5-6

- SURGICAL
- QUIRÚRGICO
- CIRÚRGICO



EMPIRE SURGICAL LTD (THE FUTURE OF HEALTHCARE)

# EXTRACTING FORCEPS FUENTES DE EXTRACCIÓN

- DELICATE PATTERN
- SQUARE PROFILE  
FOR A SAFE GRIP
- SMOOTH AND EVEN  
OPENING AND CLOSING
- HANDLES FULLY SERRATED

Selected forceps are also available as PREMIUM pattern in superior quality.

- PATRÓN DELICADO
- PERFIL CUADRADO  
PARA UN AGARRE SEGURO
- SUAVE Y AUN,  
ABRIENDO Y CERRANDO
- MANILLAS COMPLETAMENTE  
SERRADAS

Las pinzas seleccionadas también son disponible como patrón PREMIUM en calidad superior.

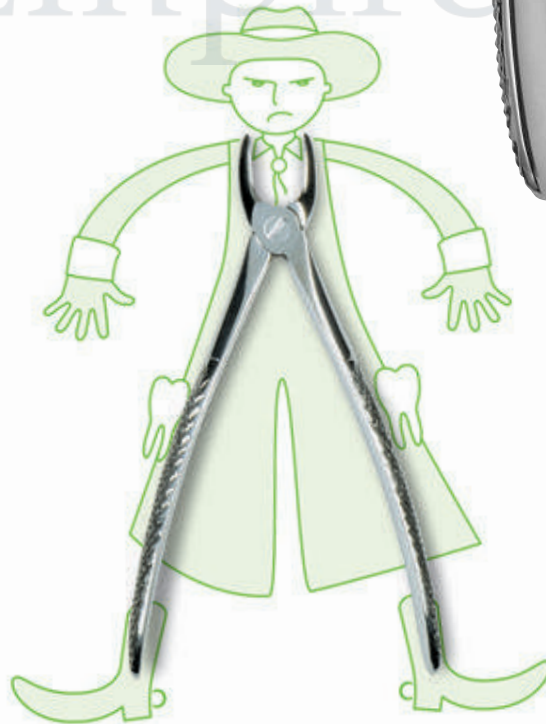



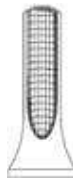

FIG.1  
 upper incisors and  
 canines, wide  
 incisivos superiores y  
 caninos, de ancho  
 incisivos superiores e  
 caninos, largos  
 E-P600-01 PREMIUM  
 E-600-01



FIG.2  
 upper incisors  
 and canines  
 incisivos superiores  
 y caninos  
 incisivos superiores  
 e caninos  
 E-P600-02 PREMIUM  
 E-600-02



FIG.7  
 upper bicuspid  
 bicúspides superiores  
 pré-molares superiores  
 E-P600-07 PREMIUM  
 E-600-07



FIG.MD1  
 Upper Incisors, Canines  
 Premolars and Roots  
 Incisivos superiores, caninos  
 Premolares y raíces  
 Incisivos superiores, caninos  
 Premolares e raízes  
 E-P600-MD1 PREMIUM  
 E-600-MD1



FIG.MD2  
 Upper 1st, 2nd,  
 and 3rd Molars  
 Upper 1st, 2nd,  
 y terceros molares  
 Superior 1st, 2nd,  
 e terceiro molares  
 E-P600-MD2 PREMIUM  
 E-600-MD2



FIG.MD3  
 Lower Incisors,  
 and Roots  
 Incisivos inferiores  
 y raíces  
 Incisivos Inferiores  
 e Raízes  
 E-P600-MD3 PREMIUM  
 E-600-MD3



FIG.MD4  
 Lower 1st, 2nd,  
 and 3rd Molars  
 inferior 1st, 2nd,  
 y terceros molares  
 Inferior 1st, 2nd  
 e terceiro molares  
 E-P600-MD4 PREMIUM  
 E-600-MD4



FIG. 17  
 upper molars, right side  
 molares superiores, lado derecho  
 molares superiores,  
 lado direito  
 E-P600-17 PREMIUM  
 E-600-17



FIG. 18  
 upper molars, left side  
 molares superiores, lado izquierdo  
 molares superiores,  
 lado esquerdo  
 E-P600-18 PREMIUM  
 E-600-18



FIG. 89  
 upper molars, right,  
 gripping in depth  
 molares superiores, a la derecha,  
 agarre en profundidad  
 molares superiores direito  
 segurando em profundidade  
 E-P600-89 PREMIUM  
 E-600-89

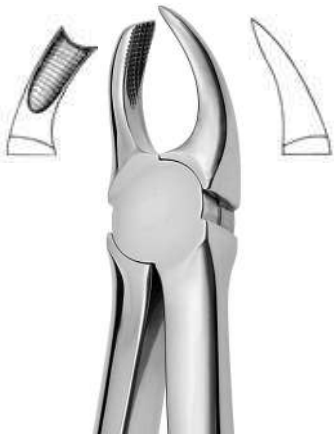

FIG. 90  
 upper molars, left,  
 gripping in depth  
 molares superiores, izquierda,  
 agarre en profundidad  
 molares superiores à esquerda  
 segurando em profundidade  
 E-P600-90 PREMIUM  
 E-600-90



FIG. 67  
 upper wisdom teeth, narrow  
 muelas del juicio superiores, estrechas  
 dentes do siso superiores, estreitos  
 E-600-67



FIG. 67A  
 upper wisdom teeth,  
 wide  
 las muelas del juicio superiores,  
 amplio  
 dentes do siso superiores,  
 Largo  
 E-P600-67A PREMIUM  
 E-600-67A



FIG.29  
upper front roots  
raíces frontales superiores  
raíces frontais superiores  
E-P600-29 PREMIUM  
E-600-29



FIG.30  
upper roots  
raíces superiores  
raíces superiores  
E-P600-30 PREMIUM  
E-600-30

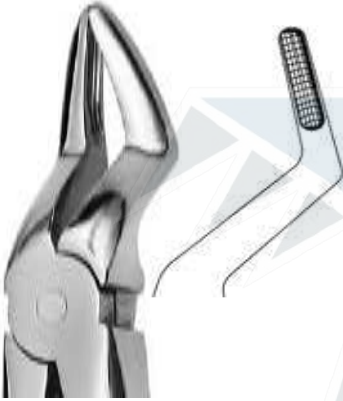

FIG.51  
upper roots, short and narrow beaks  
raíces superiores, cortas y picos estrechos  
raíces superiores, curtas e bicos estreitos  
E-P600-51 PREMIUM  
E-600-51

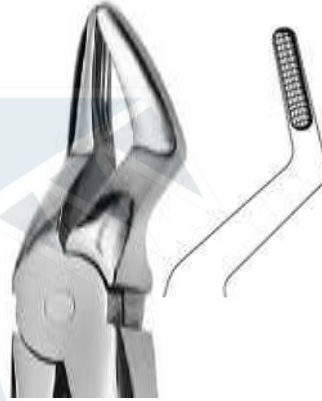

FIG.51A  
upper front roots, narrow beaks  
raíces frontales superiores, picos estrechos  
raíces frontais superiores bicos estreitos  
E-P600-51A PREMIUM  
E-600-51A



FIG.76  
upper roots  
raíces superiores  
raíces superiores  
E-600-76



upper roots, narrow  
raíces superiores, estrecho  
raíces superiores, estreitas  
E-600-76N





FIG.4  
 lower canines  
 caninos inferiores  
 caninos inferiores  
 E-P600-04 PREMIUM  
 E-600-04



FIG.13  
 lower canines and bicuspids  
 caninos y bicúspides  
 inferiores  
 caninos inferiores e pré-molares  
 E-P600-13 PREMIUM  
 E-600-13



FIG.22  
 lower molars,  
 either side  
 molares inferiores,  
 cualquier lado  
 molares inferiores de ambos os lados  
 E-P600-22 PREMIUM  
 E-600-22



FIG.73  
 lower molars  
 molares inferiores  
 molares inferiores  
 E-P600-73 PREMIUM  
 E-600-73



FIG.75  
 lower canines and bicuspids  
 caninos y bicúspides inferiores  
 caninos inferiores e pré-molares  
 E-P600-75 PREMIUM  
 E-600-75



FIG.33  
 lower roots  
 raíces inferiores  
 raíces inferiores  
 E-P600-33 PREMIUM  
 E-600-33



FIG.33A  
 lower roots,  
 with narrow beaks  
 con picos estrechos raíces inferiores  
 raíces inferiores, com bicos estreitos  
 E-P600-33A PREMIUM  
 E-600-33A





FIG. 86A  
 lower molars, gripping in depth,  
 lateral  
 molares inferiores, agarre en profundidad,  
 lateral  
 molares inferiores, segurando em  
 profundidade, lateral  
 E-P600-86A PREMIUM  
 E-600-86A



FIG. 86C  
 lower molars, gripping in depth, lateral  
 molares inferiores, agarre en profundidad,  
 lateral  
 molares inferiores, gripng em  
 profundidade, laterais  
 E-600-86C

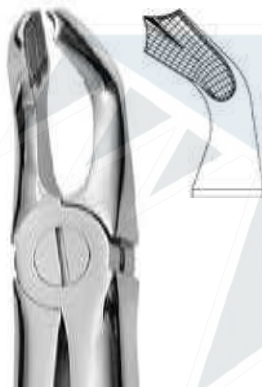

FIG. 79  
 lower wisdom teeth  
 muelas del juicio inferiores  
 dentes do siso inferiores  
 E-P600-79 PREMIUM  
 E-600-79



FIG. 79A  
 lower wisdom teeth  
 muelas del juicio inferiores  
 dentes do siso inferiores  
 E-600-79A

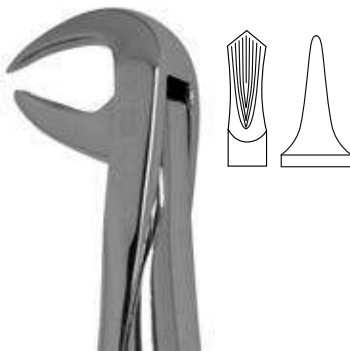

FIG. 99  
 lower molars  
 molares inferiores  
 molares inferiores  
 E-600-99

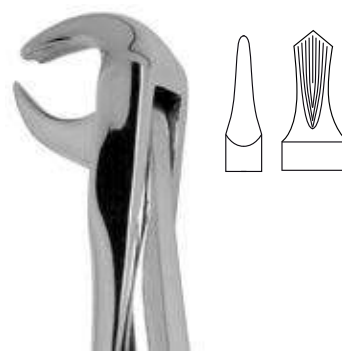

FIG. 99 1/4  
 lower molars  
 molares inferiores  
 molares inferiores  
 E-600-99/1/4





FIG. 34

upper incisors and canines,  
gripping depth  
incisivos superiores y caninos,  
profundidad de agarre  
incisivos superiores e caninos,  
profundidade de preensão  
E-600-34

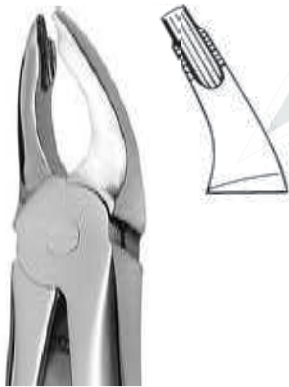

FIG. 35

upper premolars,  
gripping depth  
premolares superiores,  
profundidad de agarre  
pré-molares superiores,  
profundidade de preensão  
E-600-35



FIG. 36

lower roots, gripping depth  
raíces inferiores, profundidad  
de agarre  
raíces inferiores, profundidade  
de preensão  
E-600-36



FIG. 74

lower roots, wide beaks  
raíces inferiores, picos anchos  
Raíces inferiores, bicos largos  
E-P600-74 PREMIUM  
E-600-74



FIG. 74N

lower roots  
and crowded incisors,  
narrow beaks  
raíces inferiores y incisivos  
atestados, picos estrechos  
raíces inferiores e incisivos  
lotados, bicos estreitos  
E-P600-74N PREMIUM  
E-600-74N



FIG. 46L

very fine lower roots,  
gripping depth  
muy finas raíces inferiores,  
profundidad de agarre  
raíces inferiores muito finas  
profundidade de preensão  
E-P600-46L PREMIUM  
E-600-46L

FOR CHILDREN  
PARA NIÑOS



FIG. 37  
upper incisors  
incisivos superiores  
incisivos superiores  
E-600-37



FIG. 39  
upper molars,  
either side, wide  
molares superiores,  
a ambos lados, ancho  
molares superiores de ambos  
os lados, largos  
E-600-39



FIG. 39L  
upper molars, left  
molares superiores, izquierda  
molares superiores, esquerda  
E-600-39L



FIG. 39R  
upper molars, right  
molares superiores, derecha  
molares superiores direito  
E-600-39R



FIG. 51S  
upper roots  
raíces superiores  
raíces superiores  
E-600-51S



FIG. 29S  
upper incisors and roots,  
either side  
incisivos superiores y raíces,  
cualquier lado  
incisivos e raíces superiores,  
qualquer lado  
E-600-29S

SET OF EXTRACTING FORCEPS FOR CHILDREN  
 CONJUNTO DE FUENTES DE EXTRACCIÓN PARA NIÑOS



FIG. 13S  
 lower incisors and bicuspids  
 incisivos inferiores y bicúspides  
 incisivos inferiores e pré-molares  
 E-600-13S



FIG. 22S  
 lower molars  
 molares inferiores  
 molares inferiores  
 E-600-22S



FIG. 33S  
 molares inferiores  
 untere Wurzeln  
 raíces inferiores  
 E-600-33S

Set of Extracting Forceps for children (7 pcs)  
 Conjunto de fórceps de extracción para niños  
 (7 piezas)  
 Conjunto de extração de fórceps para  
 crianças (7 peças)

- FIG. 37 upper incisors  
 incisivos superiores  
 incisivos superiores
- FIG. 39 upper molars, either side  
 molares superiores, en ambos lados  
 molares superiores de ambos os lados
- FIG. 51S upper roots  
 raíces superiores  
 raíces superiores
- FIG. 29S upper incisors and roots, either side  
 incisivos superiores y raíces, en ambos lados  
 incisivos superiores e raíces, de cada lado
- FIG. 13S lower incisors and bicuspids  
 incisivos inferiores y bicúspides  
 incisivos inferiores e pré-molares
- FIG. 22S lower molars, either side  
 los molares inferiores, cualquier lado  
 molares inferiores de ambos os lados
- FIG. 33S lower roots  
 raíces inferiores  
 raíces inferiores



FOR CHILDREN  
PARA NIÑOS



FIG. 3  
upper molars  
molares superiores  
molares superiores  
E-605-03



FIG. 137  
upper incisors  
incisivos superiores  
incisivos superiores  
E-605-137



FIG. 139  
upper milk molars  
molares superiores de la  
leche  
molares de leite superiores  
E-605-139



FIG. 515  
upper roots  
raíces superiores  
raíces superiores  
E-605-515



FIG. 5  
lower incisors  
incisivos inferiores  
incisivos inferiores  
E-605-05



FIG. 6  
lower molars  
molares inferiores  
molares inferiores  
E-605-06



FIG. 7  
lower roots  
raíces inferiores  
raíces inferiores  
E-605-07



SET OF EXTRACTING FORCEPS (INCLUDING 10 FORCEPS)  
 CONJUNTO DE FUENTES DE EXTRACCIÓN (INCLUIDAS 10 FUENTES)  
 CONJUNTO DE FORÇAS EXTRACIONANTES (INCLUINDO 10 FORCEPS)

- P600/SET Premium Set  
 600/SET Standard Set
- FIG.2 upper incisors and canines  
 incisivos superiores y caninos  
 incisivos superiores e caninos
- FIG.7 upper bicuspid  
 bicúspides superiores  
 pré-molares superiores
- FIG.17 upper molars, right side  
 upper molars, right side  
 molares superiores, lado direito
- FIG.18 upper molars, left side  
 molares superiores, lado izquierdo  
 molares superiores, lado esquerdo
- FIG.67A upper wisdom teeth, wide  
 las muelas del juicio superiores, anchas  
 dentes do siso superiores, largos
- FIG.51A upper front roots, narrow beaks  
 Raíces frontales superiores, picos angostos  
 raízes frontais superiores, bicos estreitos
- FIG.13 lower canines and bicuspid  
 caninos y bicúspides inferiores  
 caninos inferiores e pré-molares
- FIG.22 lower molars, either side  
 los molares inferiores, cualquier lado  
 molares inferiores de ambos os lados
- FIG.33 lower roots  
 raíces inferiores  
 raízes inferiores
- FIG.79 lower wisdom teeth  
 muelas del juicio inferiores  
 dentes do siso inferiores



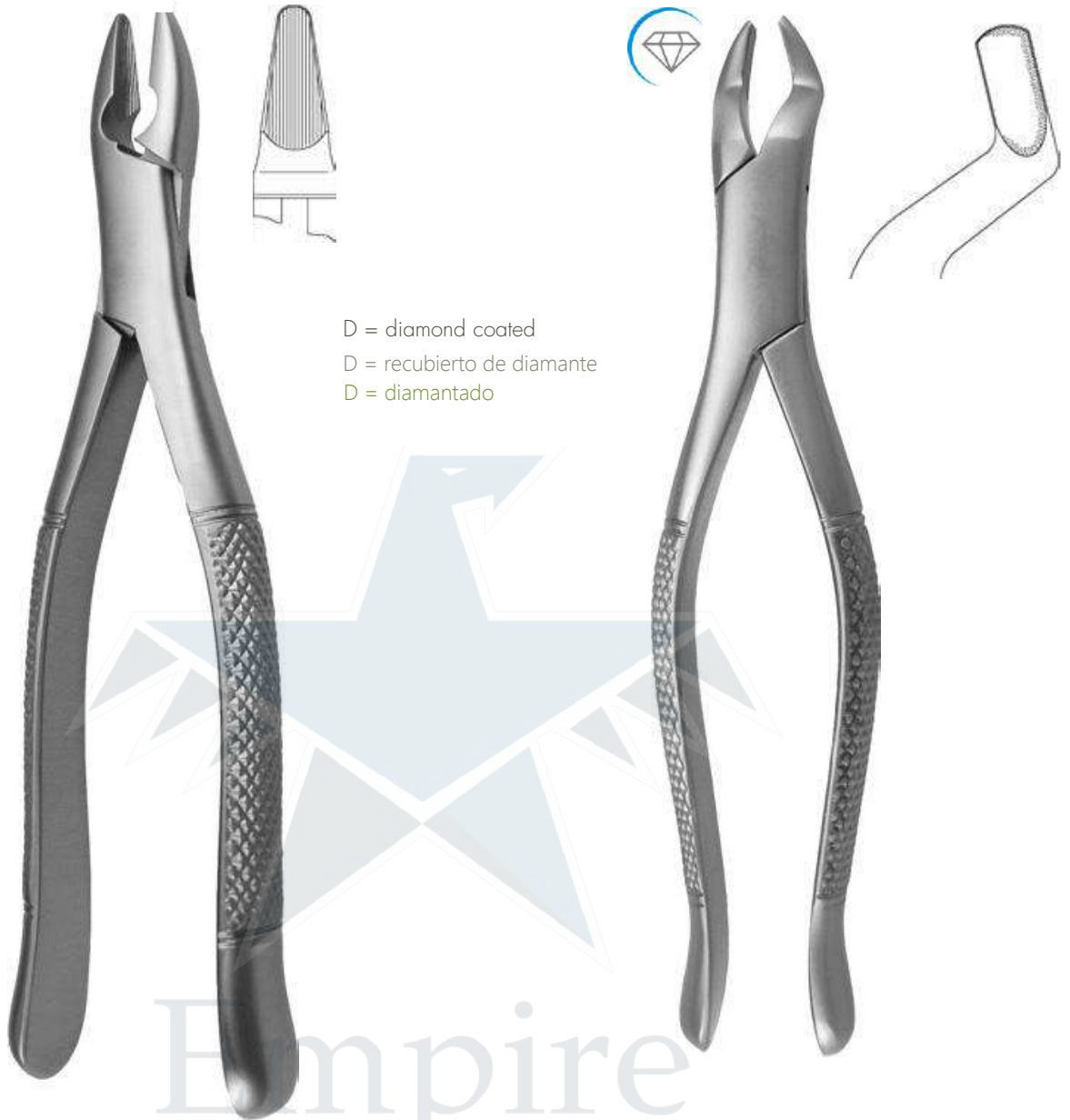

D = diamond coated  
 D = recubierto de diamante  
 D = diamantado

Upper incisors,  
 canines, bicuspid  
 caninos, bicúspides  
 Incisivos superiores,  
 incisivos superiores  
 caninos, bicúspides  
 [18cm  
 E-602-01

Upper and  
 third molars  
 Superior y  
 terceros molares  
 Molares superiores  
 e terceiros  
 E-602-10S  
 E-602-10SD 



ALSO AVAILABLE IN THIS HANDLE  
 TAMBIÉN DISPONIBLE EN ESTE MANGO



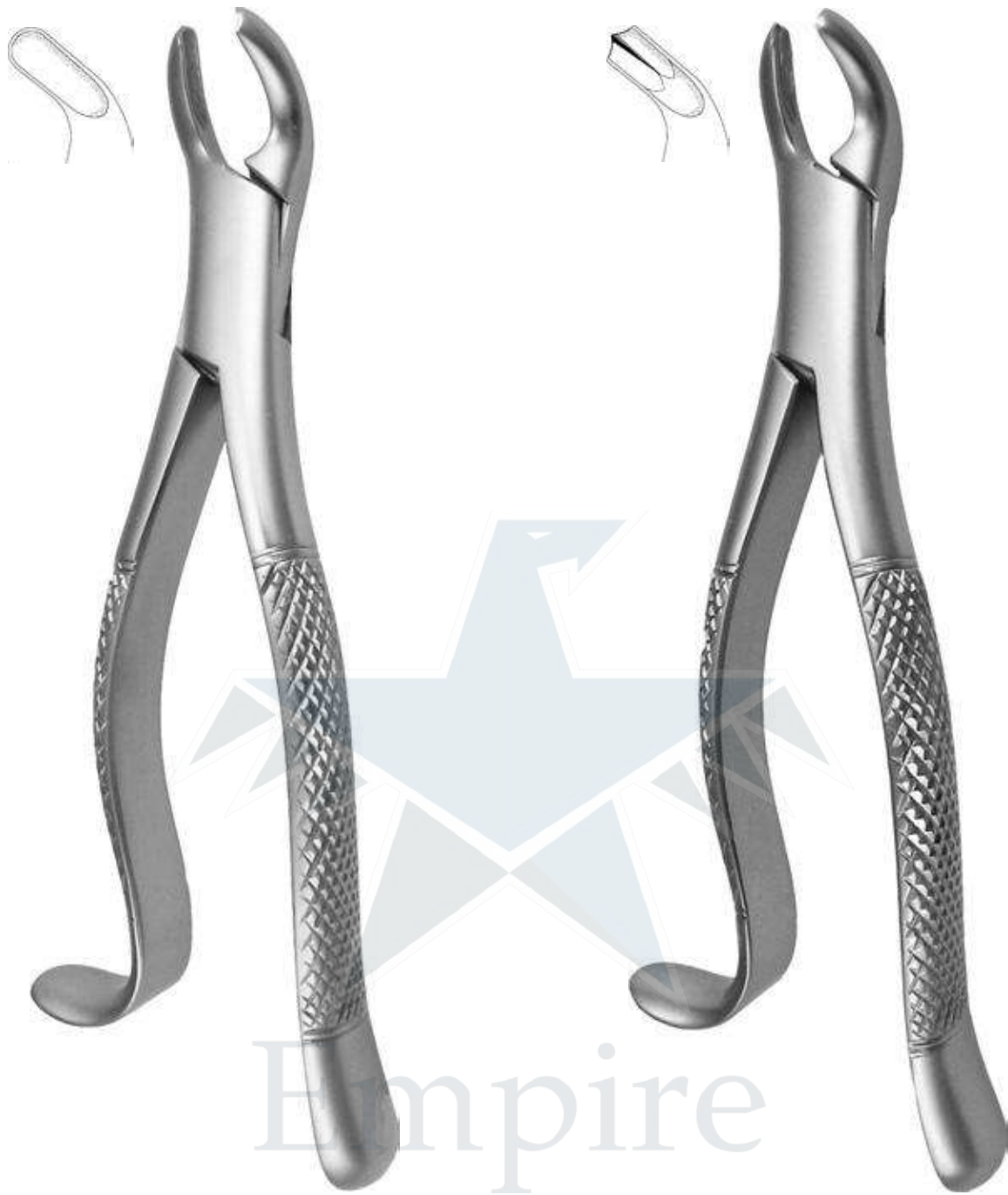

Upper molars left side  
 Molares superiores lado izquierdo  
 Lado superior dos molares superiores  
 E-602-18L

Upper molars right side  
 Molares superiores lado derecho  
 Lado superior dos molares superiores  
 E-602-18R



ALSO AVAILABLE IN THIS HANDLE  
 TAMBIÉN DISPONIBLE EN ESTE MANGO

EXTRACCIÓN  
 FUENTES EXTRAÍBLES PATRÓN AMERICANO



Narrow roots and root splinters, for upper and lower jaws  
 Raíces estrechas y astillas de raíz, para la parte superior y mandíbulas inferiores  
 Raíces estreitas e lascas de raíz para maxilas superiores e inferiores  
 [18cm  
 E-602-65



Upper molars, left side  
 Molares superiores lado izquierdo  
 Molares superiores, lado esquerdo  
 E-602-53L  
 E-602-53LD 



Upper molars, right side  
 Molares superiores lado derecho  
 Molares superiores, lado esquerdo  
 E-602-53R  
 E-602-53RD 



Upper molars, left side, gripping in depth  
 Molares superiores, lado izquierdo, agarre en profundidad  
 Molares superiores, lado esquerdo, segurando em profundidade  
 E-602-88L



Upper molars, right side, gripping in depth  
 Molares superiores, lado derecho, agarre en profundidad  
 Molares superiores, lado direito, segurando em profundidade  
 E-602-88R



Lower Root, Upper Root  
Lower Root, Upper Root  
Raiz Inferior, Raiz Superior  
E-602-69



Lower Molars  
First, Second and Third  
Molares inferiores  
Primero, segundo y tercer  
Molares inferiores  
Primero, segundo y tercer  
E-602-16S

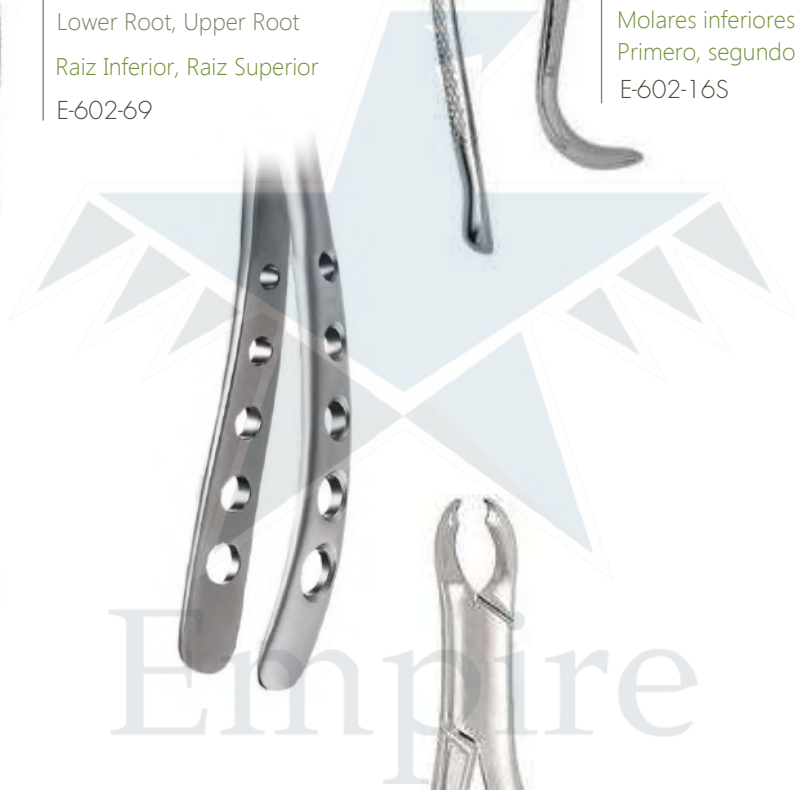

Upper Molars, First,  
second and third  
Molares superiores, primero,  
segundo y tercero  
Molares superiores, primeiro,  
segundo e terceiro  
E-602-10H

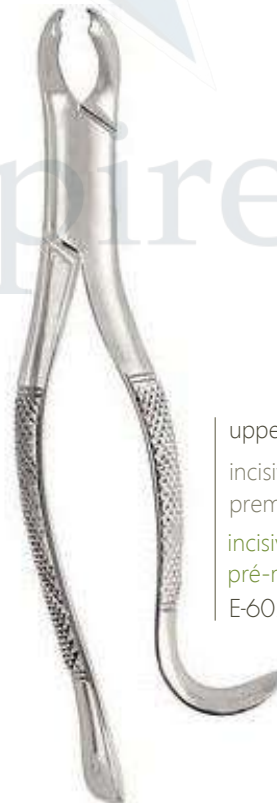

upper incisors, canines, premolars, roots  
incisivos superiores, caninos,  
premolares, raíces  
incisivos superiores, caninos,  
pré-molares, raíces  
E-602-15



Upper Canines, Premolars  
and Molars  
Caninos superiores, premolares  
y molares  
Caninos Superiores, Pré-molares  
e molares  
E-602-32A



Upper Canines, Premolars  
and Molars  
Caninos superiores, premolares  
y molares  
Caninos Superiores, Pré-molares  
e molares  
E-602-32



Lower molars, First and second,  
Molares inferiores, primero  
y segundo,  
Molares inferiores, primeiro  
e segundo,  
E-602-16



Upper and Lower Incisors,  
Canines, Premolars  
Incisivos superiores e inferiores,  
Caninos, premolares  
Incisivos superiores e inferiores,  
Caninos, Premolars  
E-602-62







Upper cuspids and Bicuspids  
Cúspides superiores y Bicúspides  
Cúspides superiores e bicúspides  
E-602-101



Upper molars, right side,  
Molares superiores, lado derecho,  
Molares superiores, lado direito,  
E-602-89



Upper molars, left side,  
Molares superiores, lado izquierdo,  
Molares superiores, lado esquerdo,  
E-602-90



Upper incisors, caniens  
and premolars  
Incisivos superiores, caninos  
y premolares  
Incisivos superiores, caninos  
e pré-molares  
E-602-99C

Empire



Upper third molars  
Terceros molares superiores  
Terceiros molares superiores  
E-602-210H



Upper third molars,  
Terceros molares superiores  
Terceiros molares superiores  
E-602-210S



Lower third molars  
Terceros molares inferiores  
Múltiplos terceiros molares  
E-602-222



Lower Incisors, Canines,  
Premolars, and Roots  
Incisivos inferiores, caninos,  
Premolares y raíces  
Incisivos Inferiores, Caninos,  
Premolars e raízes  
E-602-203







Lower Incisors, Canines,  
Premolars, and Roots  
Incisivos inferiores, caninos,  
Premolares y raíces  
Incisivos Inferiores, Caninos,  
Premolares e raíces  
E-602-151A



Upper Incisors, Canines,  
and Premolars  
Incisivos superiores, caninos,  
y premolares  
Incisivos superiores, caninos,  
e pré-molares  
E-602-151AS



ALSO AVAILABLE IN THIS HANDLE  
TAMBIÉN DISPONIBLE EN ESTE MANGO



Empire



Lower molars  
Molares inferiores  
Molares inferiores  
E-602-3FS

Upper Universal Forceps  
Pinzas universales superiores  
Pinça Universal Superior  
E-602-150AS



ALSO AVAILABLE IN THIS HANDLE  
TAMBIÉN DISPONIBLE EN ESTE MANGO



Upper incisors, canines, bicuspid and roots  
 Incisivos superiores, caninos, bicúspides y raíces  
 Incisivos superiores, caninos, bicúspides e raíces  
 18cm  
 E-602-150  
 E-602-150D 



Upper incisors and roots  
 Incisivos superiores y raíces  
 Incisivos superiores e raíces  
 E-602-286  
 E-602-286D 



Lower molars  
 Molares inferiores  
 Molares inferiores  
 E-602-17  
 E-602-17D 



Lower molars, either side  
 Molares inferiores cualquier lado  
 Molares inferiores de ambos os lados  
 E-602-23  
 E-602-23D 



Lower incisors, canines, bicuspid and roots  
 Incisivos inferiores, caninos, bicúspides y raíces  
 Incisivos inferiores, caninos, bicúspides e raíces  
 E-602-151  
 E-602-151D 

# FOR CHILDREN PARA NIÑOS

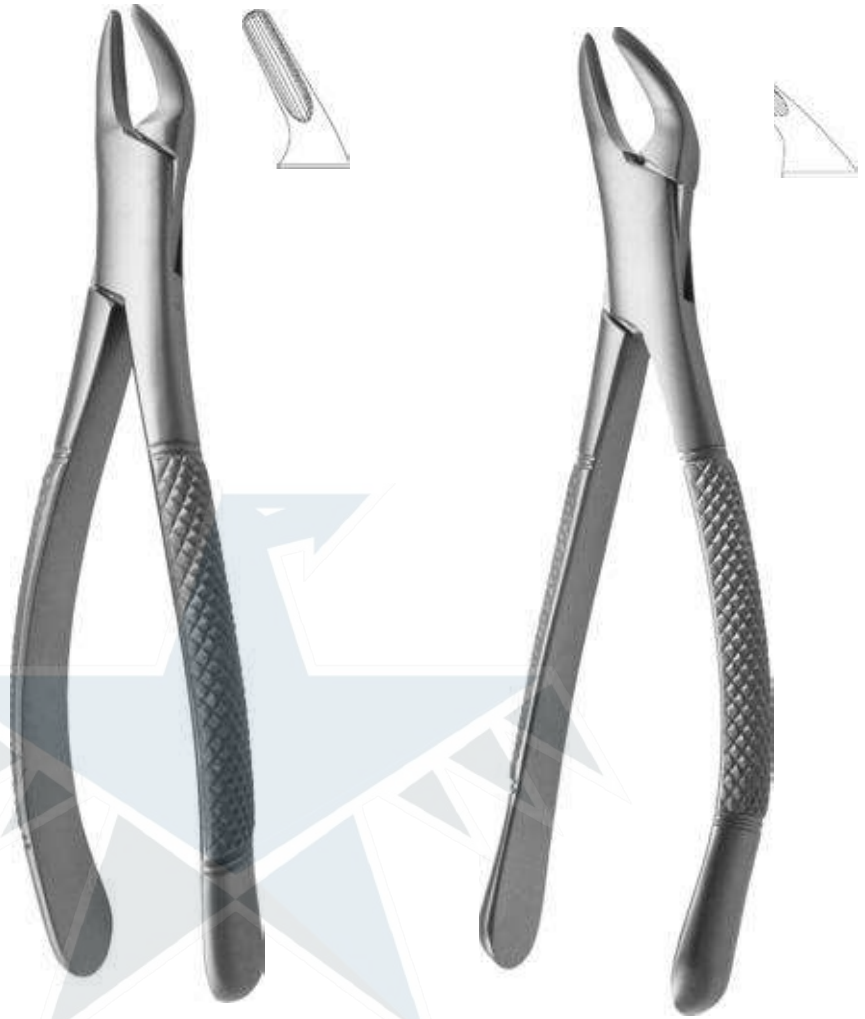

Upper incisors, canines and  
bicuspids

Incisivos superiores,  
caninos y bicúspides

Incisivos superiores,  
caninos e bicúspides  
15cm

E-602-150S

Lower incisors, canines,  
bicuspids and molars

Incisivos inferiores, caninos,  
bicúspides y molares

Incisivos inferiores, caninos,  
bicúspides e molares  
15cm

E-602-151S



ALSO AVAILABLE IN THIS HANDLE  
TAMBIÉN DISPONIBLE EN ESTE MANGO



Lower molars  
molares inferiores  
molares inferiores  
15cm  
E-602-17SK



Lower molars  
molares inferiores  
molares inferiores  
15cm  
E-602-23SK



ALSO AVAILABLE IN THIS HANDLE  
TAMBIÉN DISPONIBLE EN ESTE MANGO





Lower universal,  
baja universal  
menor universal  
E-604-23

Lower molars,  
molares inferiores  
molares inferiores  
E-604-25

Upper anterior,  
anterior superior  
anterior superior  
E-604-27

# GOLD PLATED CHAPADO EN ORO



Lower anterior  
Anterior inferior  
Anterior inferior

E-603-17



Upper universal  
Superior universal  
Universal superior

E-603-19



Universal upper molar,  
Molar superior universal,  
Molar superior universal,

E-603-21





Dental premium forceps  
Pinzas dentales premium  
Pinça dentária premium

E-608-26



Side grasping forceps  
Pinzas de agarre lateral  
Pinça de agarrar lateral

E-608-47



WITZEL  
E-610-01



Root Splinter Forceps  
Pinzas para astillas de raíces  
Pinça Raiz Splinter  
E-610-05

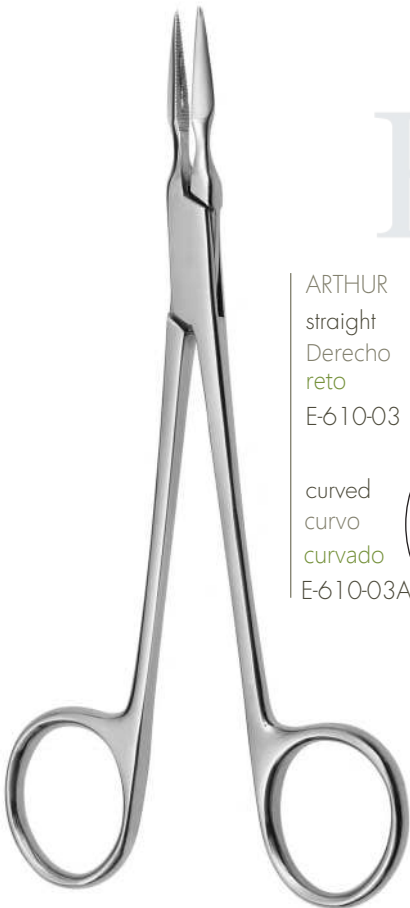

ARTHUR  
straight  
Derecho  
reto  
E-610-03

curved  
curvo  
curvado  
E-610-03A

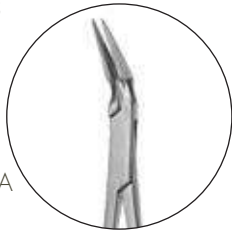

STIEGLITZ  
straight  
Derecho  
reto  
E-610-04

curved  
curvo  
curvado  
E-610-04A



Empire

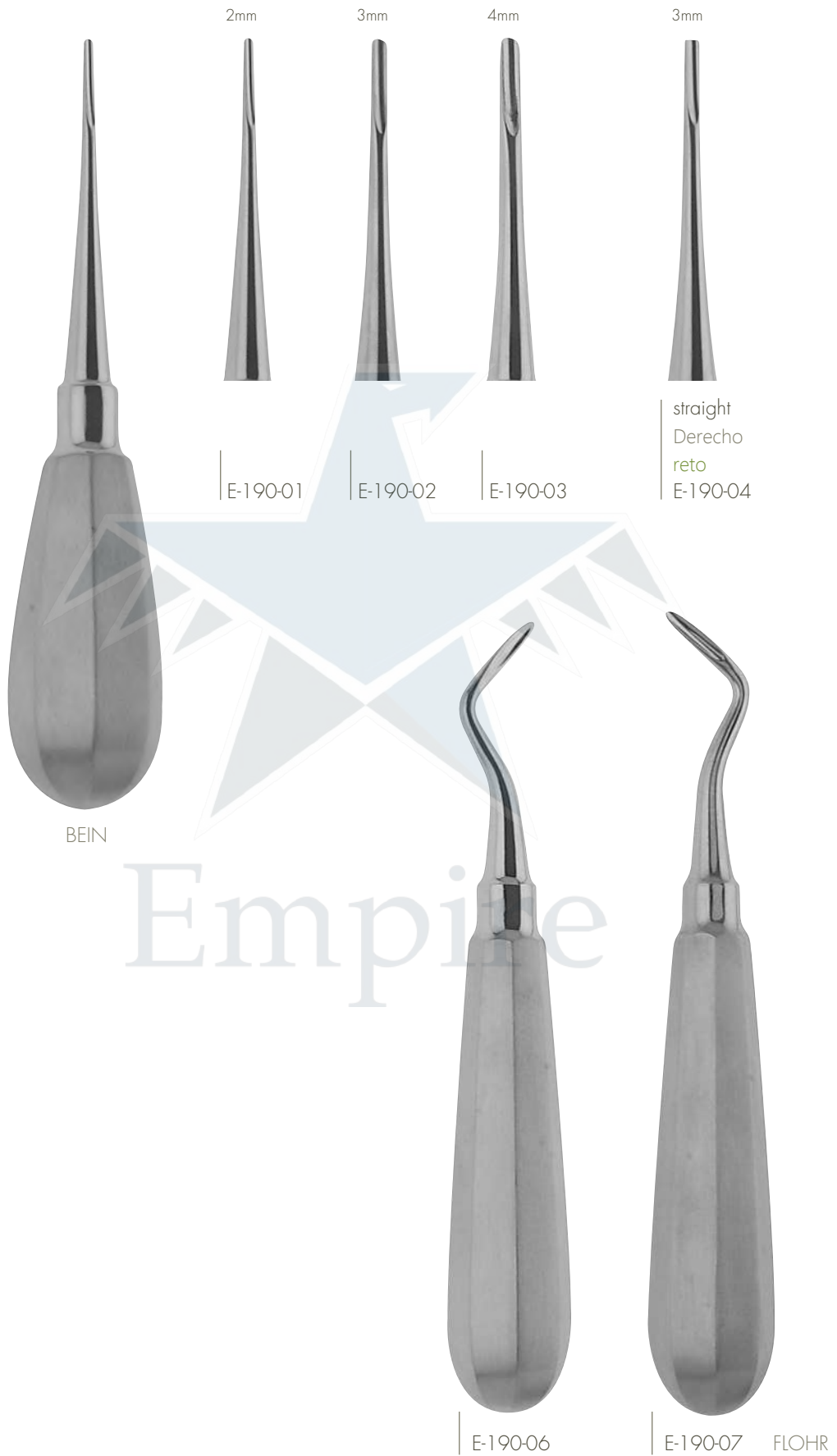





CRYER  
E-190-13



CRYER  
E-190-14



BARRY  
E-190-B50



BARRY  
E-190-B51



APICAL 2  
E-193-302



APICAL 3  
E-193-303



APICAL 1  
E-193-301





lussatore, str  
Derecho  
reto  
4.0mm  
E-192-25

lussatore, curved  
curvo  
curvado  
3.0mm  
E-192-30



lussatore, curved  
curvo  
curvado  
5.0mm  
E-192-31



lussatore, str  
Derecho  
reto  
3.0mm  
E-192-26



lussatore, str  
Derecho  
reto  
5.0mm  
E-192-26



lussatore, str  
Derecho  
reto  
4.0mm  
E-192-25



lussatore, curved  
curvo  
curvado  
4.0mm  
E-192-32

3mm

3,5mm

4mm



E-190-22



E-190-23



E-190-24

LINDO LEVIN

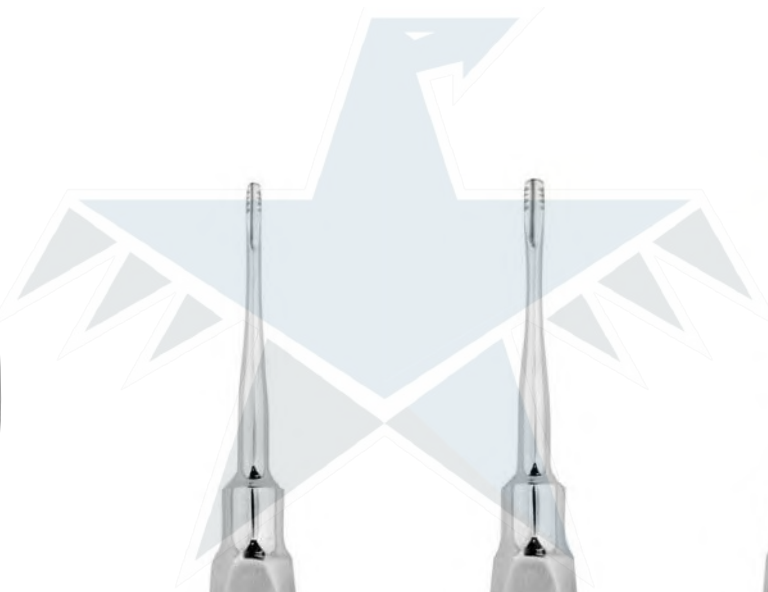

LINDO LEVIN

SMALL  
PEQUEÑA  
PEQUENO  
E-190-25



MEDIUM  
MEDIO  
MÉDIO  
E-190-26



LARGE  
GRANDE  
AMPLA  
E-190-27

EXTRACCIÓN  
LUXADORES / SINOMESOTOMES

124

LUXATORS / SYNDESMOTOMES EXTRACTION

SPECIAL HANDLE  
MANGO ESPECIAL



COGSWELL A  
E-189-08



COGSWELL B  
E-189-09



COGSWELL 77  
E-189-10



FLOHR 1  
E-189-11



FLOHR 2 LEFT  
E-189-12



FLOHR 3 RIGHT  
E-189-13



SERRATED 77R  
E-189-17

Empire

» Elevators with special Empire® Handle

» Ascensores con especial Manija del Imperio



APICAL 302

E-189-22



APICAL 301

E-189-21



SELDIN 1 EAST

E-189-26



APICAL 303

E-189-23



# Empire



SELDIN 1 WEST

E-189-27



SELDIN 304W

E-189-28



SELDIN 35

E-189-29

EXTRACCIÓN ELEVADORES DE RAÍZ

126

ROOT ELEVATORS EXTRACTION



SPECIAL HANDLE  
MANGO ESPECIAL



BAYONET 2  
E-189-32



BAYONET1  
E-189-31



HEIDBRINK ROOT TIP  
PICK 79 LEFT  
E-189-79



HEIDBRIN ROOT TIP  
PICK 78  
STRAIGHT  
E-189-78



HEIDBRINK ROOT TIP  
PICK 80 RIGHT  
E-189-80



ROOT ELEVATOR 20  
E-189-20



ELEVATOR 81A  
E-189-81

Empire



SPADE TIP 60, BACK ACTION

E-189-60



SPADE TIP 6

E-189-61



GOUGE 46 3MM

E-189-42



SPADE TIP 60L LEF

E-189-62



EXTRACCIÓN ELEVADORES DE RAÍZ

128

ROOT ELEVATORS EXTRACTION

# Empire



CRANE PICK41

E-189-49



BEIN 2

E-189-56



POTTS 1 LEFT

E-189-83



Empire



HEIDBRINK SATIN  
2.5mm, right/derecho/certo  
E-193-12



HEIDBRINK SATIN  
2.5mm  
E-193-13



HEIDBRINK SATIN  
2.5mm, left/izquierda /esquerda  
E-193-14

COLEMAN LONDON HOSPITAL



LEFT  
4.0mm /izquierda/esquerda  
E-193-38



RIGHT  
4.0mm /derecho/certo  
E-193-39



COLEMAN  
5.0mm  
E-193-37



HYLIN, FLAT  
3.0mm  
E-193-42



FRIEDMAN  
E-193-46



FRIEDMAN  
E-193-47



FOR MOLARS AN WISDOMS  
160mm  
E-193-50



FLOHR  
3.2mm  
E-190-05



Empire



BAYONET TIP  
2.0mm  
E-193-15



KOPP  
3.6mm  
E-193-16



ROOT ELEVATOR  
3.5mm  
E-193-19



BAYONET TIP  
3.0mm  
E-193-22



ROOT ELEVATOR  
3.5mm  
E-193-24



SCHLEMMER, LEFT  
3.5mm/izquierda/esquerda  
E-193-27



SCHLEMMER, RIGHT  
3.5mm/derecho/certo  
E-193-27



BEIN, ROUND  
2.0mm  
E-193-29

Empire





COUPLAND



FIG. 1  
E-190-15



FIG. 2  
E-190-16



FIG. 3  
E-190-17



WARWICK JAMES

E-192-01

E-192-02

E-192-03



HYLIN



4 mm  
E-190-31

fig.2



3 mm  
E-190-32

fig.1



E-190-33

fig.3



E-190-34

fig.4



E-190-11



E-190-12

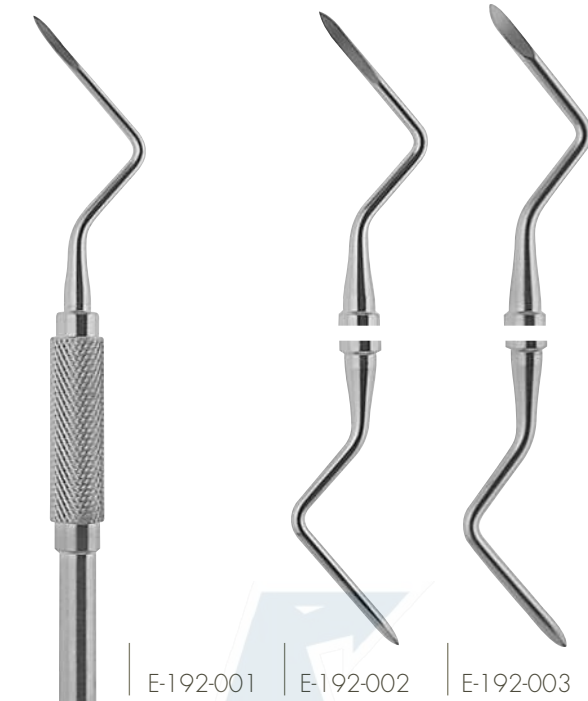

HEIDBRINK  
 Root Apex Elevator  
 Ascensor Root Apex  
 Wurzel Appex Aufzug



|E-192-11



|E-192-12



|E-192-13

HEIDBRINK  
Root Tip Pick  
Root Tip Pick  
Wurzelspitzenauswahl

Empire

|E-192-05



CHOMPRET  
Syndesmotomes  
Conexiones  
Syndesmotome



|E-192-06



|E-192-07



|E-192-08

ROOT ELEVATORS EXTRACTION

EXTRACCIÓN ELEVADORES DE RAÍZ

# TITANIUM TITANIO



mini elevator serrated, n7  
mini elevador serrado, n7  
mini elevador serrilhado, n7  
3.4mm  
E-188-07



mini elevator serrated, n6  
mini elevador serrado, n6  
mini elevador serrilhado, n6  
2.5mm  
E-188-06



mini elevator serrated, n5  
mini elevador serrado, n5  
mini elevador serrilhado, n5  
2.5mm  
E-188-05



mini elevator, serrated, n4  
mini elevador serrado, n4  
mini elevador serrilhado, n4  
2.5mm  
E-188-04



mini elevator serrated, n1  
mini elevador serrado, n1  
mini elevador serrilhado, n1  
4mm  
E-188-01



mini elevator serrated, n2  
mini elevador serrado, n2  
mini elevador serrilhado, n2  
4mm  
E-188-02



mini elevator serrated, n2  
mini elevador serrado, n2  
mini elevador serrilhado, n2  
4mm  
E-188-02S



mini elevator serrated, n3  
mini elevador serrado, n3  
mini elevador serrilhado, n3  
2.5mm  
E-188-03



mini elevator sharp , n1  
Mini ascensor n1 aguda  
mini elevador afiado, n1  
3.4mm  
E-188-11



mini elevator sharp , n2  
Mini ascensor n2 aguda  
mini elevador afiado, n2  
3.4mm  
E-188-12



mini elevator serrated , n3  
Mini ascensor n3 aguda  
mini elevador afiado, n3  
3.4mm  
E-188-13

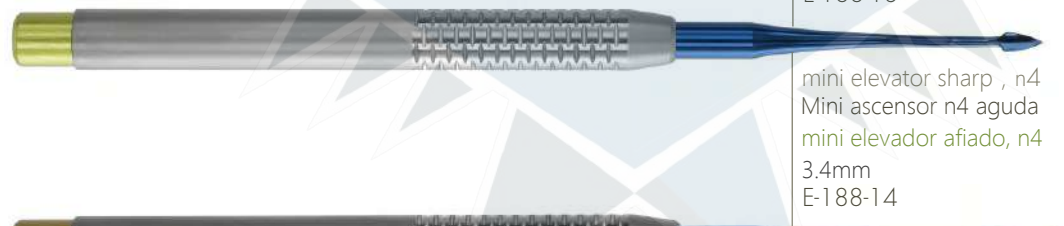

mini elevator sharp , n4  
Mini ascensor n4 aguda  
mini elevador afiado, n4  
3.4mm  
E-188-14

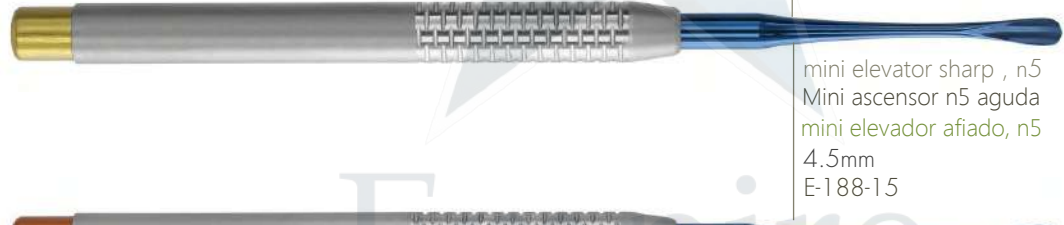

mini elevator sharp , n5  
Mini ascensor n5 aguda  
mini elevador afiado, n5  
4.5mm  
E-188-15



mini elevator sharp , n6  
Mini ascensor n6 aguda  
mini elevador afiado, n6  
4.5mm  
E-188-16

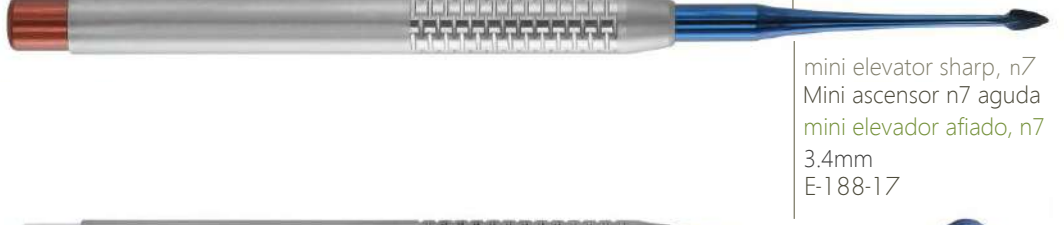

mini elevator sharp , n7  
Mini ascensor n7 aguda  
mini elevador afiado, n7  
3.4mm  
E-188-17



mini elevator sharp , n8  
Mini ascensor n8 aguda  
mini elevador afiado, n8  
3.4mm  
E-188-18



# LUXATORS LUXADORES

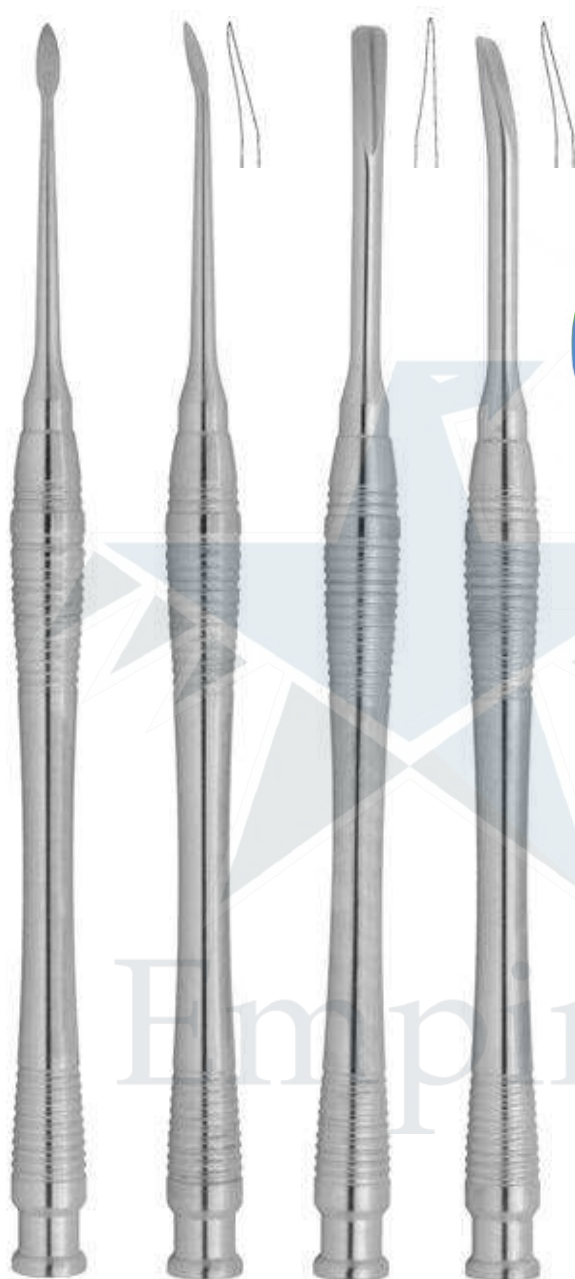

## The NEWDESIGN

Luxators are used for severing the delicate fibres connecting the tooth root with the jaw bone (ligaments) and extending the tooth socket (alveolus) thus releasing the tooth from the bone and allowing it to be removed easily. This allows the tooth to be extracted gently, which is ideal preparation for implantation.

## El NUEVO DISEÑO

Luxators se utilizan para cortar el delicado fibras que conectan la raíz del diente con el hueso de la mandíbula (ligamentos) y extender el alveolo (alvéolo) liberando así el diente del hueso y permitiendo que sea Knochen verliert und leicht entfernt werden eliminado fácilmente. Esto permite que el diente extraerse suavemente, lo que es ideal ración para la implantación.

3 mm	E-190-L1ST/ED	E-190-L1C/ED	E-190-3ST/ED	E-190-3C/ED
4 mm	E-190-L2ST/ED	E-190-L2C/ED	E-190-4ST/ED	E-190-4C/ED
4,5 mm			E-190-45ST/ED	E-190-45C/ED



3 mm | E-190-3C  
4 mm | E-190-4C  
5 mm | E-190-5C

E-190-3ST  
E-190-4ST  
E-190-5ST



3 mm | E-190-3CF  
4 mm | E-190-4CF  
5 mm | E-190-5CF

E-190-3STF  
E-190-4STF  
E-190-5STF

# LUXATORS LUXADORES



Empire



LUXATOR PERIOTOME  
Grey  
Gris  
Cinzento  
E-194-05



LUXATOR PERIOTOME  
Green  
Verde  
Verde  
E-194-08



LUXATOR PERIOTOME  
Green  
Verde  
Verde  
E-194-07



LUXATOR PERIOTOME  
Black  
Negro  
Preto  
E-194-01

LUXATOR PERIOTOME  
Dark Blue  
Azul oscuro  
Azul oscuro  
E-194-03



LUXATOR PERIOTOME  
Light Blue  
Azul claro  
Azul claro  
E-194-04



LUXATOR PERIOTOME  
Brown  
marrón  
Castanho  
E-194-06



LUXATOR PERIOTOME  
Tan  
Broncearse  
bronzado  
E-194-02





Empire



LUXATOR PERIOTOME  
Titanium  
Titanio  
Titânio  
E-194-14



LUXATOR PERIOTOME  
Titanium  
Titanio  
Titânio  
E-194-16



LUXATOR PERIOTOME  
Titanium  
Titanio  
Titânio  
E-194-17



LUXATOR PERIOTOME  
Titanium  
Titanio  
Titânio  
E-194-18



POTT  
130 X 4mm  
E-196-40



POTT  
130 X 3mm  
E-196-30



POTT  
130 X 2mm  
E-196-20





BARRY

FIG.320  
E-191-320

FIG.321  
E-191-321



WINTER

FIG.11L  
E-191-11L

FIG.11R  
E-191-11R

FIG.14L  
E-191-14L

FIG.14R  
E-191-14R

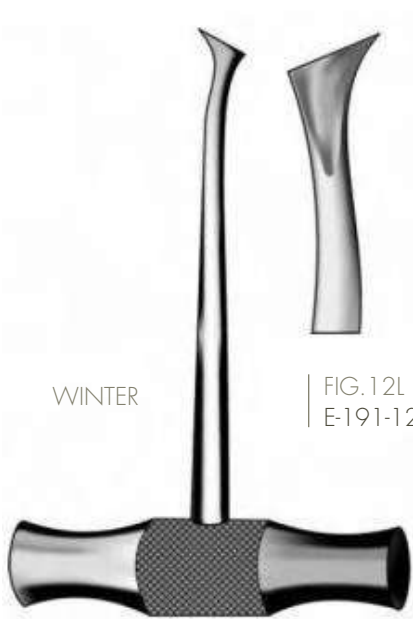

WINTER

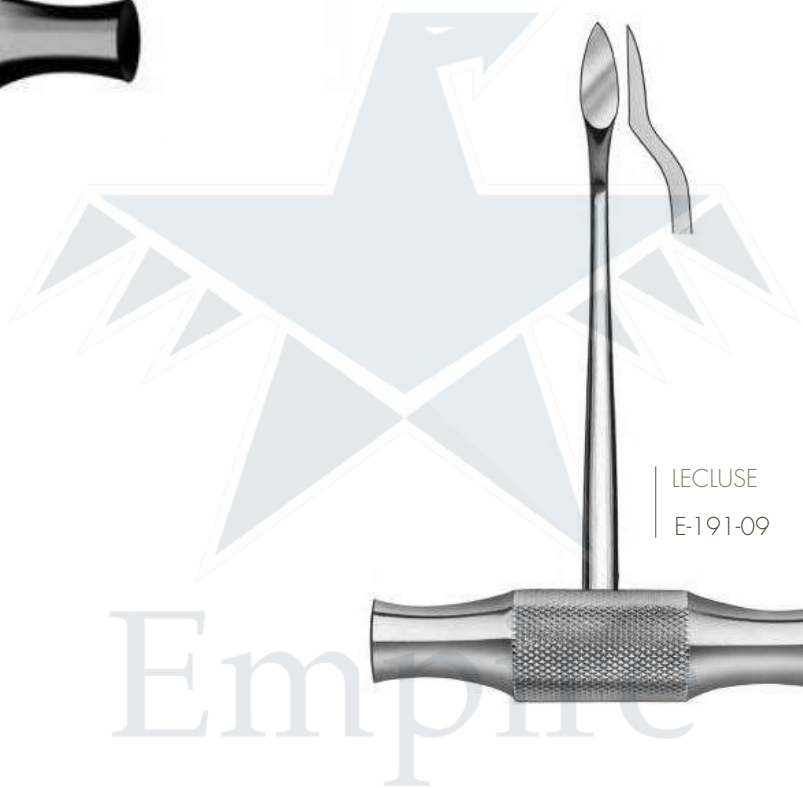

FIG.12L  
E-191-12L

FIG.12R  
E-191-12R

FIG.13L  
E-191-13L

FIG.13R  
E-191-13R



LECLUSE  
E-191-09





AUSTIN  
E-353-07

HARTMANN  
E-353-11

14cm  
E-354-W1

14,5cm  
E-354-W2

TOBOLD  
8cm  
E-354-W1

14,5cm  
E-354-W2



HILGER

Retractor only  
Solo retractor  
Retractor apenas  
E-200-07

Retractor with handle  
Retractor con mango  
Retractor com alça  
E-200-07A



FARABEUF

Set with 2 pieces  
Set con 2 piezas  
Conjunto com 2 peças

125mm  
E-353-08

150mm  
E-353-09



CAWOOD MINNESOTA  
E-354-06

Empire



BRAANEMARK  
Vestibulum Retractor  
Retractor Vestibulum  
Retractor vestibular  
E-700-02 A=80mm  
  
for children  
para niños  
para crianças  
E-700-02K A=75mm



Vestibulum and  
Cheek Retractor  
Vestibulum y  
Retractor de mejilla  
Vestibulum e Retractor  
de Bochechas  
E-700-06 A=80mm



STERNBERG  
Lip Retractor  
Retractor de labios  
Afastador de lábio  
14cm  
E-700-03



Tongue Holder  
Soporte de lengüeta  
Suporte de língua  
E-700-05



[ 170mm  
E-700-12



[ 170mm  
E-700-13

Empire



Maty Universal Retractors  
Universal-Reraktoren  
Universal-Reraktoren  
230mm  
E-700-16



COLUMBIA  
[ 150mm  
E-700-14

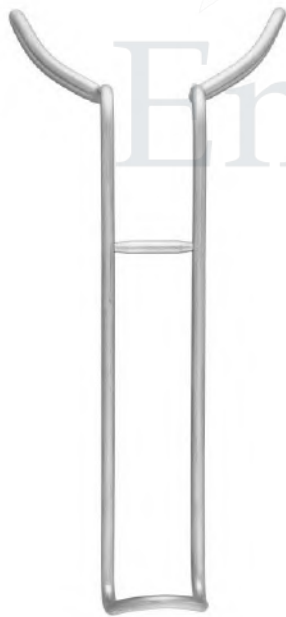

BRANEMAAK  
[ 150mm  
E-700-11



VESTIBULUM  
[ 225mm  
E-700-15

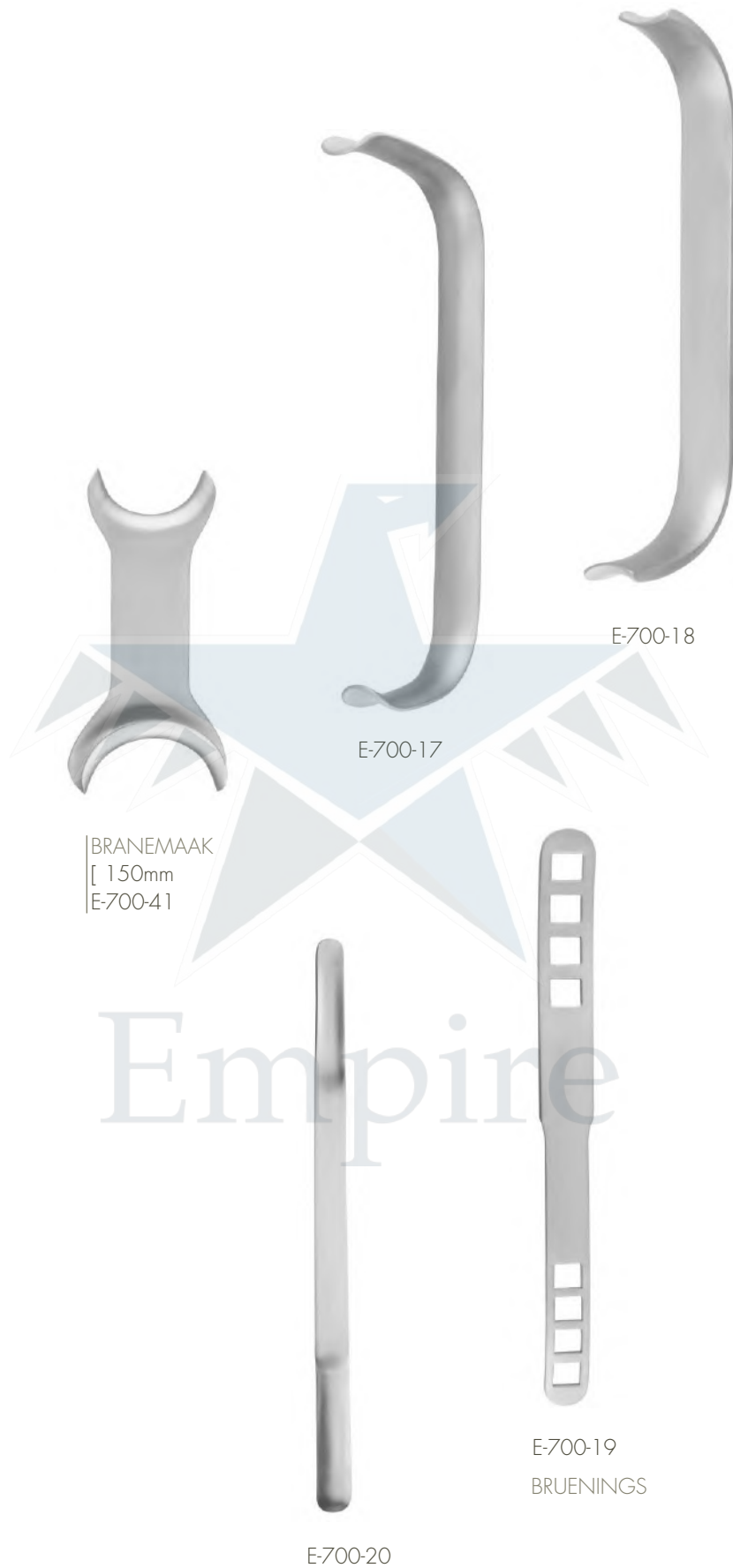

BRANEMAAK  
[ 150mm  
E-700-41

E-700-17

E-700-18

E-700-19  
BRUENINGS

E-700-20



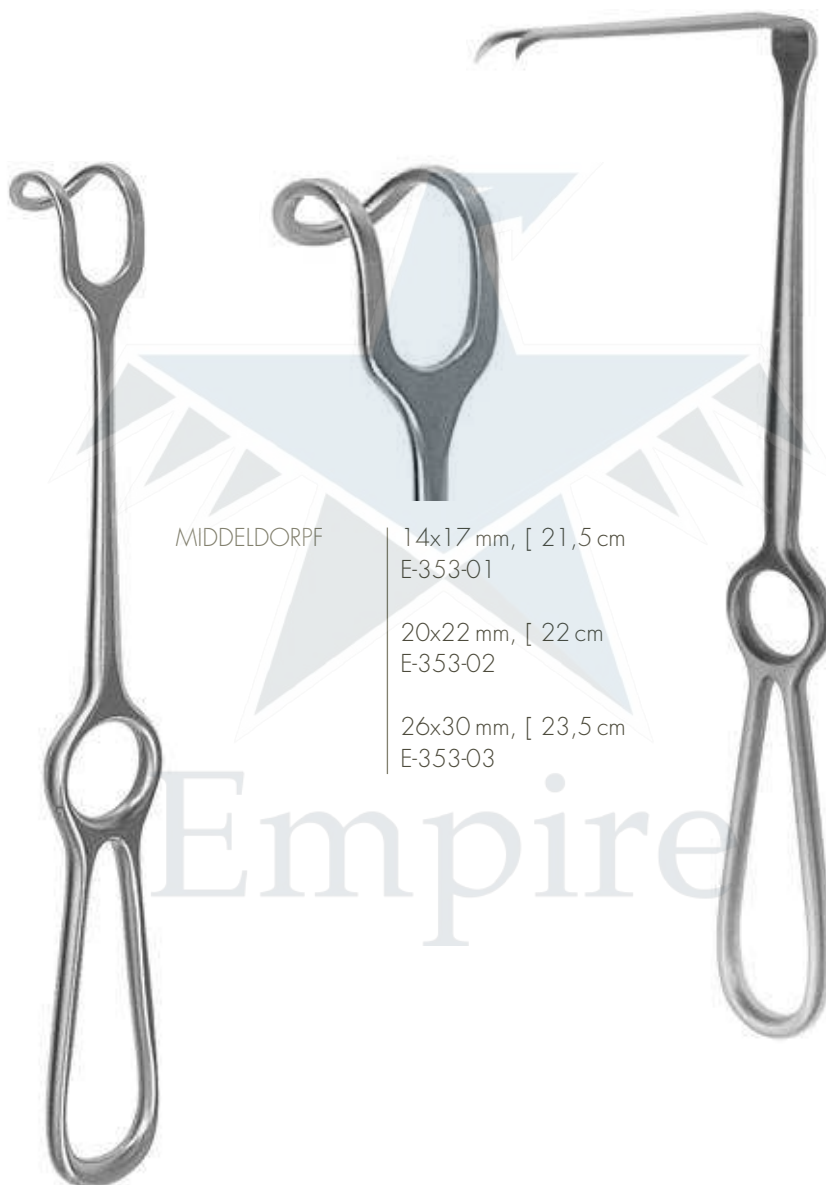

MIDDENDORPF

14x17 mm, [ 21,5 cm  
E-353-01

20x22 mm, [ 22 cm  
E-353-02

26x30 mm, [ 23,5 cm  
E-353-03

RAMUS RETRACTOR  
RETRACTOR RAMUS  
RAMUS-RETRACTOR  
72x11 mm, [ 22 cm  
E-353-05

KOCHER-LANGENBECK

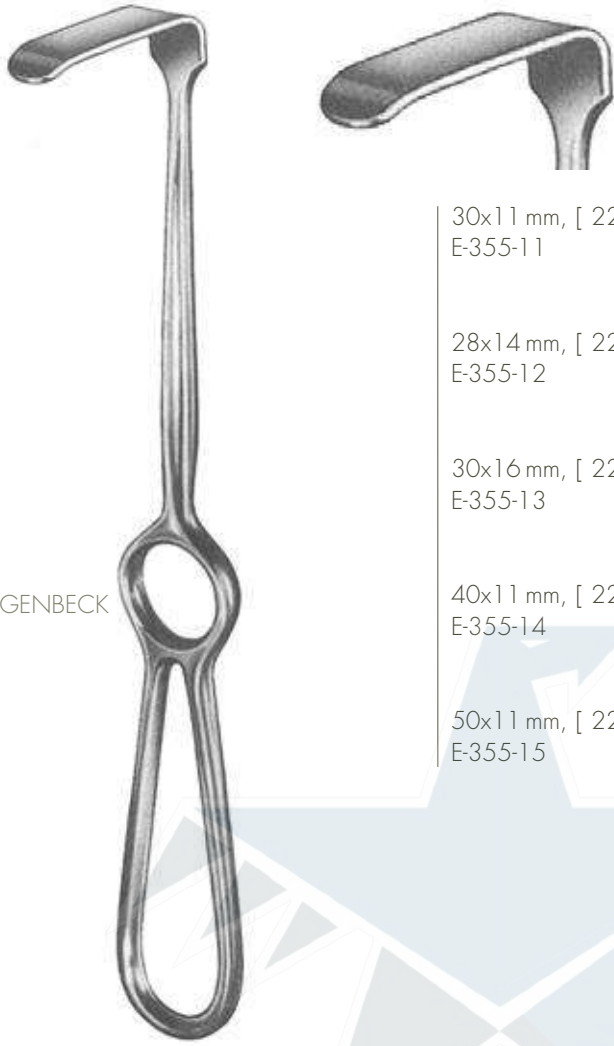

30x11 mm, [ 22 cm  
E-355-11

28x14 mm, [ 22 cm  
E-355-12

30x16 mm, [ 22 cm  
E-355-13

40x11 mm, [ 22 cm  
E-355-14

50x11 mm, [ 22 cm  
E-355-15

OBWEGESER



Mandibular Chanel Retractor  
Retractor de Chanel mandibular  
Retrator de Chanel Mandibular  
8 mm, [ 175 mm  
E-353-20

10 mm, [ 175 mm  
E-353-21

BOWDLER HENRY  
[ 19cm  
E-353-12





WASSMUND  
[ 33 X 20cm  
E-353-14



SHARP  
SCHARF  
AFIADO

SENN-MUELLER  
8 X 7mm/22 x 7mm  
155mm  
E-353-15



BLUNT  
STUMPF  
BLUNT

SENN-MUELLER  
8 X 7mm/22 x 7mm  
155mm  
E-353-16



BLUNT  
STUMPF  
BLUNT

SENN-MUELLER  
8 X 7mm/18 x 55mm  
165mm  
E-353-17





JENNINGS  
 E-700-21 11cm  
 E-700-22 13cm  
 E-700-23 15cm



ORINGER  
 E-700-02

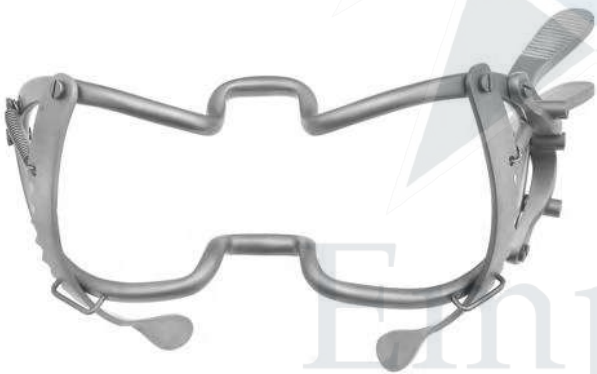

WHITEHEAD  
 15cm  
 E-700-24  
 with tongue depressor  
 con depresor lingual  
 com abaixador de língua  
 15cm  
 E-700-25



HEISTER  
 Detachable  
 Desmontable  
 Destacável  
 E-700-26



HEISTER  
 with two screws  
 con dos tornillos  
 com dois parafusos  
 E-700-27



MOLT

11cm  
E-705-04

14cm  
E-705-06



MOLT

11cm  
E-705-08

14cm  
E-705-10



DOYEN COLLIN

11cm  
E-705-12

14cm  
E-705-14



DOYEN JANSEN

11cm  
E-705-16

14cm  
E-705-18



Denhart  
13cm/ jaw 16mm  
E-700-46



Roser-Koenig  
16cm  
E-700-33



Roser-Koenig  
19cm  
E-700-32



[26.5mm  
E-702-26



[24.5mm  
E-702-25



[22mm  
E-702-22

Finger Protectors  
Protectores de dedos  
Protetores de Dedo



Fergusson-Ackland  
14.5cm  
E-700-39



Fergusson-Ackland  
18cm  
E-700-38





Davis-Boyle Mouth Gag  
E-701-00



TONGUE DEPRESSOR  
DEPRESOR DE LENGUA  
DEPRESSOR DE LÍNGUA  
100 X 26mm  
E-701-01

TONGUE DEPRESSOR  
DEPRESOR DE LENGUA  
DEPRESSOR DE LÍNGUA  
80 X 24mm  
E-701-02

TONGUE DEPRESSOR  
DEPRESOR DE LENGUA  
DEPRESSOR DE LÍNGUA  
65 X 23mm  
E-701-03



McIvor Mouth Gag Frame  
E-702-00



TONGUE DEPRESSOR  
DEPRESOR DE LENGUA  
DEPRESSOR DE LÍNGUA  
100 X 26mm  
E-702-03

TONGUE DEPRESSOR  
DEPRESOR DE LENGUA  
DEPRESSOR DE LÍNGUA  
85 X 25mm  
E-702-03

TONGUE DEPRESSOR  
DEPRESOR DE LENGUA  
DEPRESSOR DE LÍNGUA  
75 X 23mm  
E-702-03

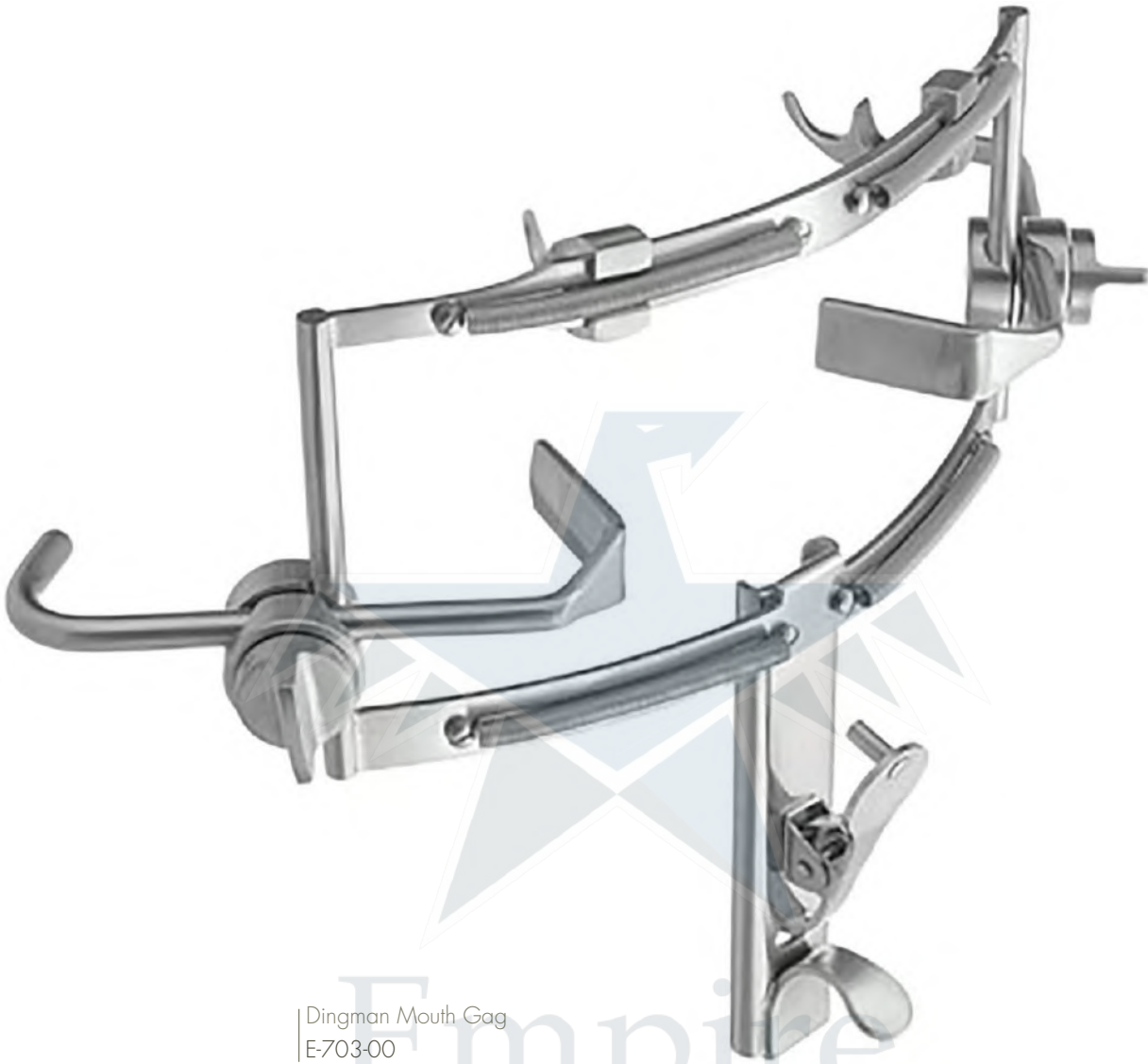

Dingman Mouth Gag  
E-703-00

Empire

lead filled head  
cabeza llena de plomo  
cabeça cheia de chumbo  
Ø 22mm / 140g

[ 16,5cm  
E-330-01

with interchangeable  
plastic disks  
con intercambiables  
discos de plástico  
com discos de plástico  
intercambiáveis

Ø 25mm / 140g

[ 18cm  
E-330-03



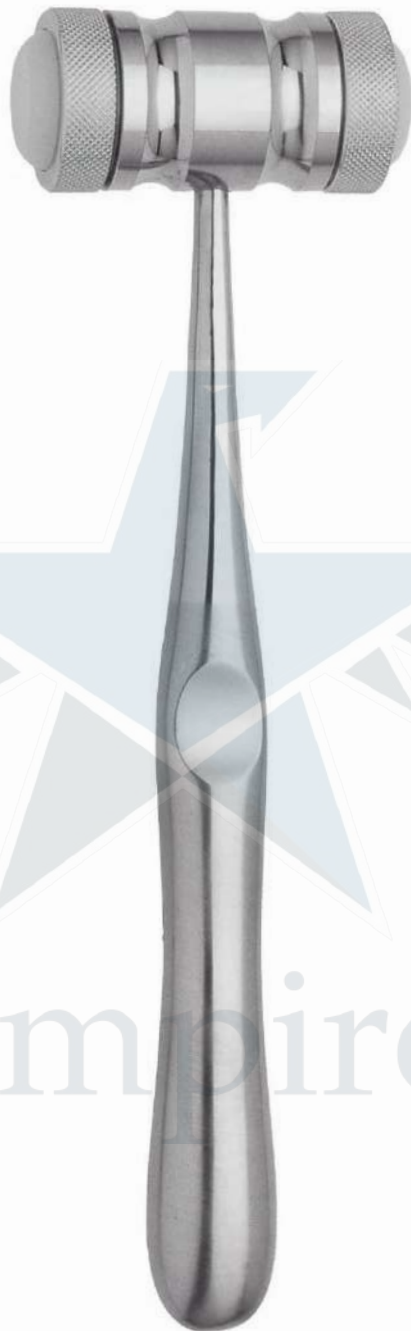

Mead Dental Mallet  
Replaceable Nylon  
Rubber Faces, Lead Filled

Mead Dental Mallet  
Nylon reemplazable  
Rubber Faces, Lead Filled

Malho Dental Mead  
Nylon Substituível Rostos  
De Borracha, Chumbo Cheio

Ø 26mm / 320g ,  
18.0 cm  
E-330-04

Empire

CIRUGÍA MAZO

MALLETS SURGERY

160



Empire



OMBREDANNE, mallet

Ø 40mm / 720g  
[ 25cm  
E-330-05



Lead Filled Mallet  
Mazo lleno de plomo  
Malho Cheio De Chumbo

Ø 22mm / 150g  
[ 16.5cm  
E-330-06



MOLT 9  
E-335-M9  
E-335-M9/ED

24 GSP  
E-335-24GSP  
E-335-24GSP/ED

BUSER  
E-335-B1  
E-335-B1/ED

GOLDMAN FOX 14  
E-335-GF14  
E-335-GF14/ED



PRICHARD PR3S  
E-335-PR3S

MOLT 10  
E-335-M10  
E-335-M10/ED

Empire



WILLIGER  
160x6 mm  
E-335-06



OBWEGESER  
[ 17,5 cm  
6 mm  
E-337-71



7 mm  
E-337-72

9 mm  
E-337-73

11 mm  
E-337-74

SELDIN S23  
[ 19,5 cm  
E-335-S23



HOWARTH  
[ 21,5 cm  
E-335-H



WILLIGER  
[ 16,5 cm  
E-337-01



sharp agudo afiado

blunt embotar contundente



FREER  
[ 18,5 cm  
E-336-05

BONE FILES ARCHIVOS DE HUESO ARQUIVOS DE OSSO

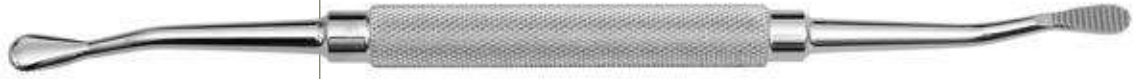

MILLER  
E-338-03

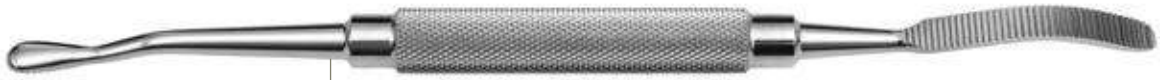

MILLER  
E-338-04



MILLER  
E-338-05

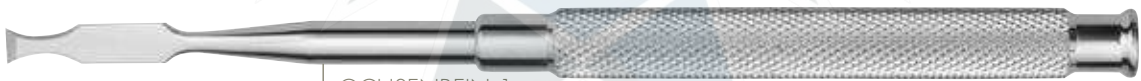

OCHSENBEIN 1  
E-332-41



OCHSENBEIN 2  
E-332-42

SHARP SPOONS CUCHARAS SHARP COLHERES AFIADAS

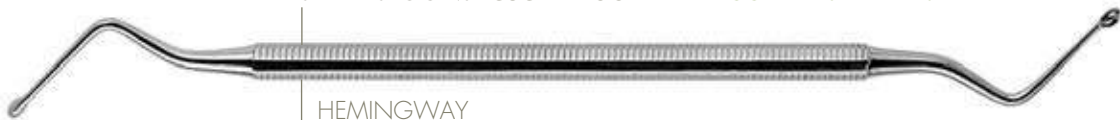

HEMINGWAY  
[ 18 cm  
2,5 mm  
E-130-01

3,0 mm  
E-130-02

3,5 mm  
E-130-03



LUKAS  
[ 18 cm  
FIG.1  
E-336-11

FIG.2  
E-336-22



Micro Blade Holder  
for Mini Blades  
Soporte Micro Blade  
para Mini cuchillas  
Suporte Micro Lâmina  
para mini lâminas  
[ 13 cm  
E-185-08MK



FIG. 3  
[ 12,5cm  
E-185-03



[ 16 cm  
E-185-05



E-185-05ED



[ 16 cm  
E-185-06



E-185-06ED



rotating blade holder  
portacuchillas giratorio  
suporte de lâmina rotativa  
[ 17 cm  
E-185-07

- » Scalpel blades  
on special request available
- » Hojas de bisturí  
a pedido especial disponible
- » Lâminas de bisturi  
a pedido especial disponível



FIG. 4  
[ 12,5cm  
E-185-04



No. 3G  
[ 12,5cm  
E-185-05



No. 7  
solid  
E-185-12



NO. 3L  
solid straight  
recta sólida  
reta sólida  
E-185-14



scalpal blade remover  
removedor de cuchillas de bisturí  
removedor de lâmina de bisturí  
[ 160mm  
E-185-17



- » stainless steel
- » acid proof
- » rostfreier Stahl
- » säurebeständig

FRAZIER  
Suction Tube  
Tubo de succión  
Tubo de sucção  
[ 19 cm  
Ø 2,0 mm  
E-195-F2/06  
Ø 3,0 mm  
E-195-F3/09  
Ø 4,0 mm  
E-195-F4/12

[ 14 cm	[ 19 cm
Ø 1,5 mm E-195-001	Ø 1,5 mm E-195-01
Ø 3,0 mm E-195-002	Ø 3,0 mm E-195-02
Ø 5,0 mm E-195-003	Ø 5,0 mm E-195-03

 with notch  
con muesca  
com entalhe

[ 14 cm	[ 19 cm
Ø 1,5 mm E-195-004	Ø 1,5 mm E-195-04
Ø 3,0 mm E-195-005	Ø 3,0 mm E-195-05
Ø 5,0 mm E-195-006	Ø 5,0 mm E-195-06



	STANDARD	SCHMAL	FEIN
[ 13cm	E-182-12	E-182-22	E-182-32
[ 14,5cm	E-182-13	E-182-23	E-182-33
[ 16cm	E-182-14	E-182-24	



# Empire



	SEMKEN straight Derecho	curved curvo
[ 12cm	reto E-182-51	curvado E-182-53
[ 15cm	E-182-52	E-182-54

POTTS-SMITH
[ 18cm E-182-41



CIRUGÍA DISEÑANDO FACHADAS

DISSECTING FORCEPS SURGER





[ 12cm  
[ 15cm



ADSON  
E-182-61  
E-182-62



MICRO ADSON  
E-182-63



McINDOE  
[ 15cm  
E-182-01

Empire



TAYLOR  
straight  
Derecho  
reto  
E-182-45

curved  
curvo  
curvado  
E-182-46



POTTS-SMITH  
straight  
Derecho  
reto  
E-182-47

curved  
curvo  
curvado  
E-182-48

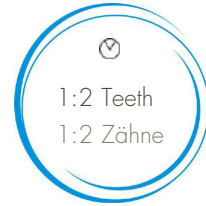

	STANDARD	SCHMAL	FEIN
[ 13cm	E-183-12	E-183-22	E-183-32
[ 14,5cm	E-183-13	E-183-23	E-183-33
[ 16 cm	E-183-14	E-183-24	



	SEMKEN straight Derecho reto	curved curvo curvado	POTTS-SMITH [ 18 cm E-183-41
[ 12cm	E-183-51	E-183-53	
[ 15 cm	E-183-52	E-183-54	



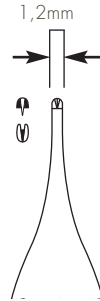

[ 12 cm  
[ 15 cm

ADSON  
E-183-61  
E-183-62

MICRO ADSON  
E-183-63  
E-183-64



GILLIES  
[ 15 cm  
E-183-02

Empire



IRIS  
[ 11cm  
straight  
Derecho  
reto  
E-240-01  
E-240-01 **SC**

curved  
curvo  
curvado  
E-240-02  
E-240-02 **SC**

GOLDMAN-FOX  
[ 13 cm  
serrated  
serrado  
serrilhada  
straight  
Derecho  
reto  
E-250-01  
E-250-01 **SC**

curved  
curvo  
curvado  
E-250-00  
E-250-00 **SC**

KELLY  
[ 16cm  
straight  
Derecho  
reto  
E-220-02  
E-220-02 **SC**

curved  
curvo  
curvado  
E-220-01  
E-220-01 **SC**

LaGRANGE  
[ 11,5cm  
E-245-01  
E-245-01 **SC**

**SC** = SUPERCUT  
very sharp edges through special grinding  
one ring gold  
bordes muy afilados a través de una molienda especial  
un anillo de oro  
bordas muito afiadas através de moagem  
especial um anel de ouro



delicate  
delicado  
delicado  
[ 14,5 cm  
straight  
Derecho  
reto  
E-217-04



curved  
curvo  
curvado  
E-218-04

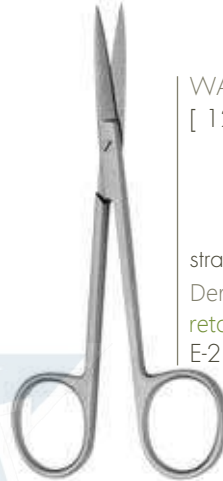

WAGNER  
[ 12 cm  
straight  
Derecho  
reto  
E-230-01



curved  
curvo  
curvado  
E-230-02

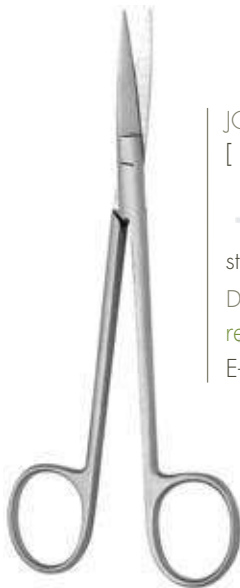

JOSEPH  
[ 14,5 cm  
straight  
Derecho  
reto  
E-235-03



curved  
curvo  
curvado  
E-235-04



SPENCER  
[ 9 cm  
E-250-20  
[ 10,5 cm  
E-250-21  
[ 12,5 cm  
E-250-22



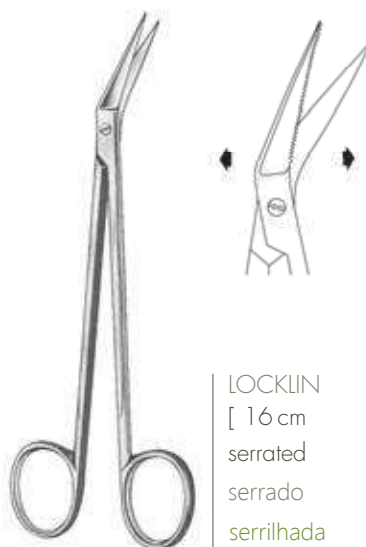

LOCKLIN  
[ 16 cm  
serrated  
serrado  
serrilhada  
E-236-02



DEAN  
[ 17 cm  
serrated  
serrado  
serrilhada  
E-242-03

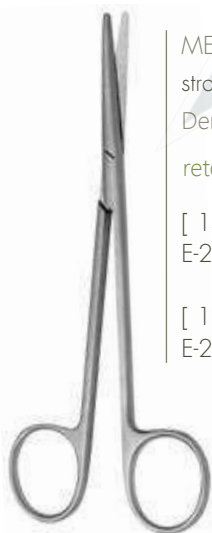

METZENBAUM  
straight  
Derecho  
reto  
[ 14 cm  
E-229-01  
[ 18 cm  
E-229-03

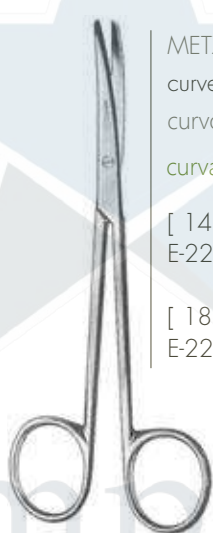

METZENBAUM  
curved  
curvo  
curvado  
[ 14 cm  
E-229-02  
[ 18 cm  
E-229-04

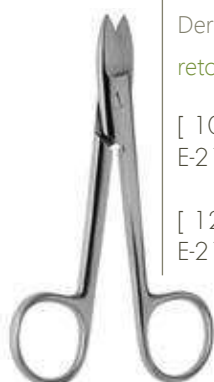

BEEBEE  
straight  
Derecho  
reto  
[ 10,5 cm  
E-210-01  
[ 12 cm  
E-210-03

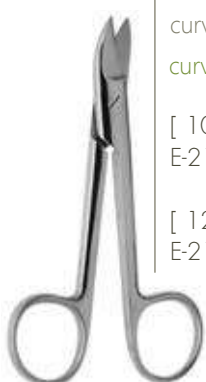

BEEBEE  
curved  
curvo  
curvado  
[ 10,5 cm  
E-210-02  
[ 12 cm  
E-210-04



UNIVERSAL  
[ 12cm  
Wire Scissors  
Tijeras de alambre  
Tesoura de arame  
E-250-05  
E-250-05 **TC**

Empire

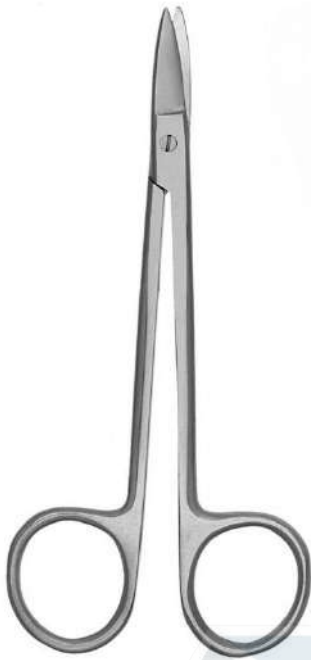

QUIMBY  
straight  
Derecho  
reto  
[ 10,5 cm  
E-222-01  
[ 12.5 cm  
E-222-03



QUIMBY  
curved  
curvo  
curvado  
[ 10,5 cm  
E-222-02  
[ 12.5 cm  
E-222-04



LITTAUER  
11.4 cm  
E-226-01



NEUMANN  
curved  
curvo  
curvado  
[ 12.5 cm  
E-226-02  
[ 12.5 cm  
E-226-04

Empire



CASTROVIEJO  
[ 14cm  
straight  
Derecho  
reto  
E-174-55 TC



curved  
curvo  
curvado  
E-174-57 TC



BARRAQUER  
[ 18cm  
straight  
Derecho  
reto  
E-174-66 TC



MICRO-CASTROVIEJO  
[ 14cm  
straight  
Derecho  
reto  
E-174-59 TC



curved  
curvo  
curvado  
E-174-60 TC



### INSTRUMENTS WITH TC INSERTS

To increase strength and hardness TC inserts are being welded into the working tips of our needle holders. By using this special material during tempering, a high HRC can be obtained which allows to achieve a perfect grind and an extraordinary lifetime of the instrument. Compared to other types of stainless steel instruments, needle holders with TC inserts are more sensitive to chemicals and require therefore special care.

### INSTRUMENTOS CON TC INSERTS

Para aumentar la fuerza y la dureza TC inserta están siendo soldadas en las puntas de trabajo de nuestros portaagujas. Al usar este especial material durante el templado, un alto HRC puede obtenerse, lo que permite lograr un molienda perfecta y una vida extraordinaria de la instrumento. Comparado con otros tipos de manchas menos instrumentos de acero, portaagujas con TC insertos son más sensibles a los productos químicos y requieren, por lo tanto, cuidados especiales.



MATHIEU  
[ 14 cm  
E-175-03  
E-175-03 TC



[ 17 cm  
E-175-02  
E-175-02 TC



3/0 - 4/0  
without TC  
ohne TC  
sem TC



CRILE WOOD  
[ 15 cm  
E-175-61  
E-175-61 TC



[ 18 cm  
E-175-62  
E-175-62 TC

3/0 - 4/0



OLSEN HEGAR  
[ 14 cm  
E-175-06  
E-175-06 TC



3/0 - 4/0



MAYO HEGAR  
[ 14 cm  
E-175-71  
E-175-71 TC



[ 16 cm  
E-175-72  
E-175-72 TC

[ 18 cm  
E-175-73  
E-175-73 TC

3/0 - 4/0

Empire

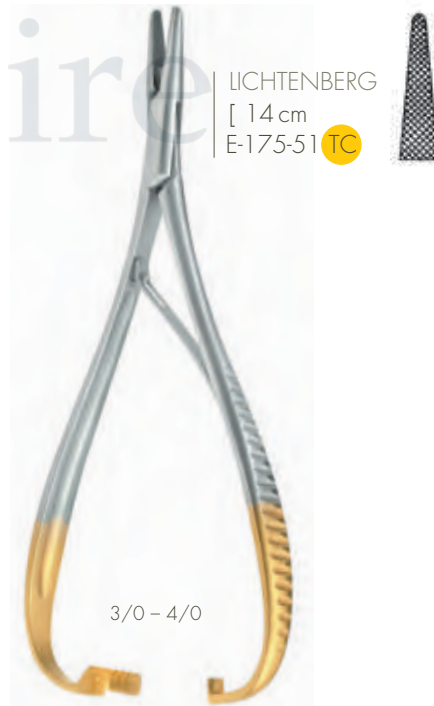



HALSY  
[ 13 cm  
E-176-03  
E-176-03 TC



3/4



KILNER  
[ 13 cm  
E-176-06  
E-176-06 TC



3/4



GILLIES  
[ 14 cm  
E-176-09  
E-176-09 TC



3/4



MICRO VASCULAR  
[ 15 cm  
E-176-12  
E-176-12 TC



[ 18 cm  
E-176-13  
E-176-13 TC

3/4





Empire



RYDER

[ 13 cm  
E-176-15  
E-176-15 TC



[ 15 cm  
E-176-16  
E-176-16 TC

[ 18 cm  
E-176-17  
E-176-17 TC



MARTIN

[ 13 cm  
E-176-18  
E-176-18 TC



DEBAKEY

[ 16 cm  
E-176-21  
E-176-21 TC



[ 20 cm  
E-176-22  
E-176-22 TC

[ 23 cm  
E-176-23  
E-176-23 TC



WEBSTERS

[ 13 cm  
E-176-24  
E-176-24 TC





HEGAR-BAUMGARTNER  
[ 13 cm  
E-176-27  
E-176-27 TC



SAROT  
[ 18 cm  
E-176-30  
E-176-30 TC



TOENNIS  
[ 18 cm  
E-176-41  
E-176-41 TC



LANGENBECK  
[ 16 cm  
E-176-44  
E-165-44 TC  
[ 18 cm  
E-176-45  
E-176-45 TC  
[ 20 cm  
E-176-46  
E-176-46 TC





Empire



MASSON  
[ 26.5 cm  
E-176-49  
E-176-49 TC



HEANEY  
[ 20 cm  
E-176-52  
E-176-52 TC



STRATTE  
[ 21 cm  
E-176-55  
E-176-55 TC



WENGENSTEEN  
[ 27 cm  
E-176-58  
E-176-58 TC

# SURGICAL BASIC SET

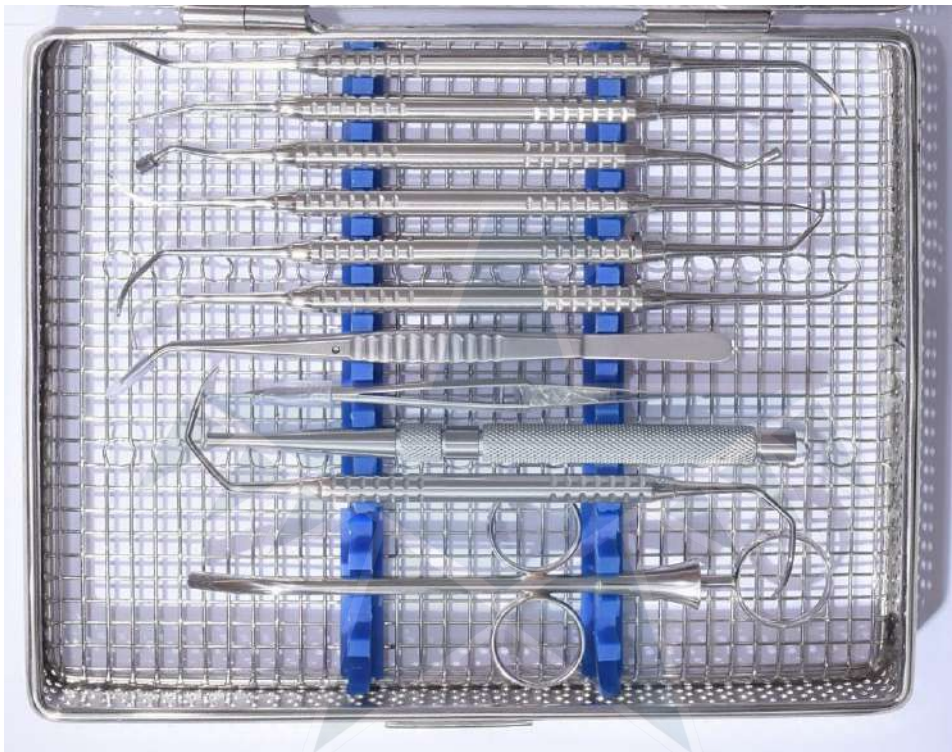

## SURGICAL BASIC SET CONTAINS

- \* 5 Sinus Curettes
- \* 1 Bone Tamper
- \* 1 Serrated Graft Paker
- \* 1 Bone Scraper
- \* 1 Graft Syringe
- \* 1 College Tweezers
- \* 1 Castroviejo Noyes Micro Scissors

Empire

## EL CONJUNTO BÁSICO QUIRÚRGICO CONTIENE

- \* 5 Curetas sinusales
- \* 1 Manipulación de hueso
- \* 1 Serrado Graft Paker
- \* 1 Raspador de huesos
- \* 1 Jeringa de injerto
- \* 1 Pinzas universitarias
- \* 1Castroviejo Noyes Micro Scissors



HALSTEAD MOSQUITO

straight

Derecho

reto

[ 12 cm

E-290-01

E-291-11

[ 14 cm

E-290-14

E-291-14

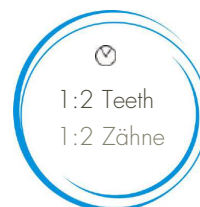

curved

curvo

curvado

[ 12 cm

E-290-02

E-291-21

[ 14 cm

E-290-15

E-291-24



MICRO-MOSQUITO

straight

Derecho

reto

[ 12 cm

E-290-11

E-291-16



curved

curvo

curvado

[ 12 cm

E-290-12

E-291-26







KELLY  
straight  
Derecho  
reto  
[ 14 cm  
E-290-31



curved  
curvo  
curvado  
[ 14 cm  
E-290-32



PROVIDENCE-HOSPITAL  
straight  
Derecho  
reto  
[ 14 cm  
E-290-35



curved  
curvo  
curvado  
[ 14 cm  
E-290-36



ALLIS  
[ 14 cm  
E-290-37



ROCHESTER-PEAN  
straight  
Derecho  
reto  
[ 14 cm  
E-290-43



curved  
curvo  
curvado  
[ 14 cm  
E-290-44





Empire



ROCHESTER-CARMALT

straight

Derecho

reto

[ 16 cm

E-290-45

curved

curvo

curvado

[ 14 cm

E-290-46



KOCHER

straight

Derecho

reto

[ 20 cm

E-290-47

curved

curvo

curvado

[ 20 cm

E-290-48



PEAN

[ 14.5 cm

E-290-49



EDNA (LORNA)  
Towel Clamp  
Abrazadera de toalla  
Braçadeira de toalha  
[ 10 cm  
E-298-33  
[ 13cm  
E-298-34

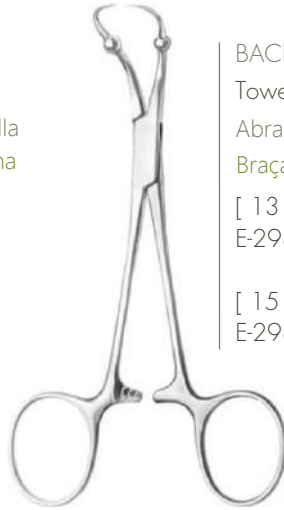

BACKHAUS-ROEDER  
Towel Clamp  
Abrazadera de toalla  
Braçadeira de toalha  
[ 13 cm  
E-298-35  
[ 15 cm  
E-298-36



BACKHAUS  
Towel Clamp  
Abrazadera de toalla  
Braçadeira de toalha  
[ 9cm  
E-298-31  
[ 11cm  
E-298-32

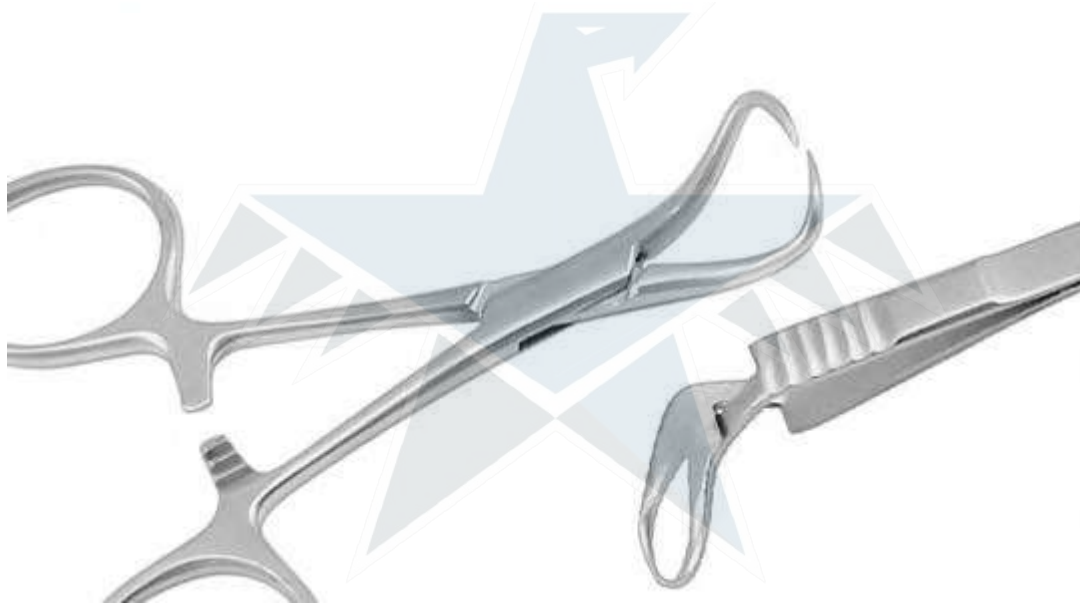

Empire



JONES  
Towel Clamp  
Abrazadera de toalla  
Braçadeira de toalha  
[ 9cm  
E-298-01



SCHAEDEL  
Towel Clamp  
Abrazadera de toalla  
Braçadeira de toalha  
[ 9cm  
E-298-02



MINI FRIEDMANN  
[ 12 cm/ 2.5mm  
E-136-001



FRIEDMANN  
[ 14 cm/2.5mm  
E-136-00

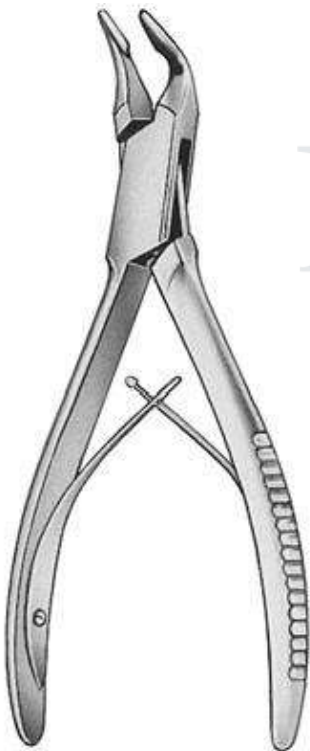

BLUMENTHAL  
[ 15,5cm/ 3mm

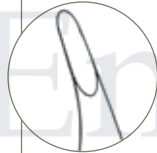

E-136-31

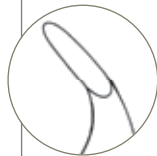

E-136-32

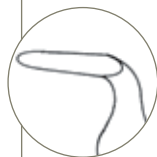

E-136-33



LUER  
[ 15cm



E-136-51

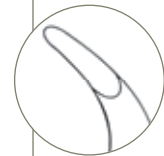

E-136-52



E-136-53



HARTMANN  
[ 18 cm/3mm  
E-136-04



BÖHLER  
[ 15 cm/ 2mm  
E-137-01



MEAD  
[ 16.5 cm/ 4mm  
E-136-51



RUSKIN  
[ 19 cm/ 5mm  
E-137-06



Empire



BEYER  
Bone Rongeur Forceps  
Bone Rongeur Forceps  
Pinça de osso Rongeur

18 cm/ 3mm  
E-137-15



CLEVELAND  
Bone Cutting Forceps  
Fórceps de corte de hueso  
Pinça de corte ósseo

17 cm  
E-136-42



KERRISON  
Bone Rongeur  
Rongeur de hueso  
Rongeur ósseo  
90 x 5.0 x 5.0mm  
E-136-50

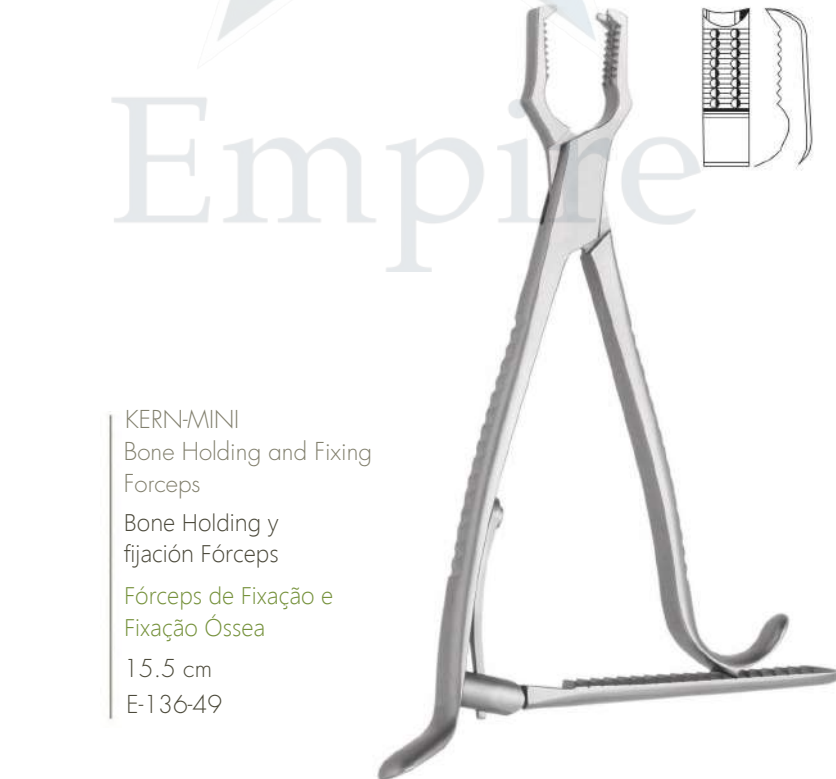

KERN-MINI  
Bone Holding and Fixing  
Forceps  
Bone Holding y  
fijación Fórceps  
Fórceps de Fixação e  
Fixação Óssea  
15.5 cm  
E-136-49



- ANAESTHESIA
- ANESTESIA
- ANESTESIA



EMPIRE SURGICAL LTD (THE FUTURE OF HEALTHCARE)

# CARTRIDGE SYRINGE

# JERINGUILLA CARTUCHO



WITH ASPIRATION DEVICE  
 CON DISPOSITIVO DE ASPIRACIÓN  
 COM DISPOSITIVO DE ASPIRAÇÃO

metric thread 1,8 ml  
 hilo métrico 1,8 ml  
 rosca métrica 1,8ml  
 E-370-18M

US thread 1,8cc  
 US thread 1,8cc  
 rosca US 1,8cc  
 E-370-18US

metric thread 2,2ml  
 hilo métrico 2,2 ml  
 rosca métrica 2,2ml  
 E-370-22M

US thread 2,2cc  
 US thread 2,2cc  
 rosca US 2,2cc  
 E-370-22US

WITHOUT ASPIRATION DEVICE  
 SIN DISPOSITIVO DE ASPIRACIÓN  
 COM DISPOSITIVO DE ASPIRAÇÃO

metric thread 1,8 ml  
 hilo métrico 1,8 ml  
 rosca métrica 1,8ml  
 E-371-18M

US thread 1,8cc  
 US thread 1,8cc  
 rosca US 1,8cc  
 E-371-18US

metric thread 2,2ml  
 hilo métrico 2,2 ml  
 rosca métrica 2,2ml  
 E-371-22M

US thread 2,2cc  
 US thread 2,2cc  
 rosca US 2,2cc  
 E-371-22US



Empire



WITH ASPIRATION DEVICE  
CON DISPOSITIVO DE ASPIRACIÓN  
COM DISPOSITIVO DE ASPIRAÇÃO

metric thread 1,8 ml  
hilo métrico 1,8 ml  
rosca métrica 1,8ml  
E-372-18M

US thread 1,8cc  
US thread 1,8cc  
rosca US 1,8cc  
E-372-18US

metric thread 2,2ml  
hilo métrico 2,2 ml  
rosca métrica 2,2ml  
E-372-22M

US thread 2,2cc  
US thread 2,2cc  
rosca US 2,2cc  
E-372-22US

WITH ASPIRATION DEVICE  
CON DISPOSITIVO DE ASPIRACIÓN  
COM DISPOSITIVO DE ASPIRAÇÃO

metric thread 1,8 ml  
hilo métrico 1,8 ml  
rosca métrica 1,8ml  
E-373-18M

US thread 1,8cc  
US thread 1,8cc  
rosca US 1,8cc  
E-373-18US

metric thread 2,2ml  
hilo métrico 2,2 ml  
rosca métrica 2,2ml  
E-373-22M

US thread 2,2cc  
US thread 2,2cc  
rosca US 2,2cc  
E-373-22US

WITH ASPIRATION DEVICE  
CON DISPOSITIVO DE ASPIRACIÓN  
COM DISPOSITIVO DE ASPIRAÇÃO

metric thread 1,8 ml  
hilo métrico 1,8 ml  
rosca métrica 1,8ml  
E-369-18M

US thread 1,8cc  
US thread 1,8cc  
rosca US 1,8cc  
E-369-18US

metric thread 2,2ml  
hilo métrico 2,2 ml  
rosca métrica 2,2ml  
E-369-22M

US thread 2,2cc  
US thread 2,2cc  
rosca US 2,2cc  
E-369-22US

Empire



THREE RING CARTRIDGE SYRINGE  
 JERINGA DEL CARTUCHO DE TRES ANILLOS  
 TRÊS SERINGAS DE CARTUCHO DE ANEL

metric thread 1,8 ml  
 hilo métrico 1,8 ml  
 rosca métrica 1,8ml  
 E-376-18M

US thread 1,8cc  
 US thread 1,8cc  
 rosca US 1,8cc  
 E-376-18US

metric thread 2,2ml  
 hilo métrico 2,2 ml  
 rosca métrica 2,2ml  
 E-376-22M

US thread 2,2cc  
 US thread 2,2cc  
 rosca US 2,2cc  
 E-376-22US

THREE RING CARTRIDGE SYRINGE  
 JERINGA DEL CARTUCHO DE TRES ANILLOS  
 TRÊS SERINGAS DE CARTUCHO DE ANEL

metric thread 1,8 ml  
 hilo métrico 1,8 ml  
 rosca métrica 1,8ml  
 E-377-18M

US thread 1,8cc  
 US thread 1,8cc  
 rosca US 1,8cc  
 E-377-18US

metric thread 2,2ml  
 hilo métrico 2,2 ml  
 rosca métrica 2,2ml  
 E-377-22M

US thread 2,2cc  
 US thread 2,2cc  
 rosca US 2,2cc  
 E-377-22US



Empire



THREE RING CARTRIDGE SYRINGE  
JERINGA DEL CARTUCHO DE TRES ANILLOS  
TRÉS SERINGAS DE CARTUCHO DE ANEL

metric thread 1,8 ml  
hilo métrico 1,8 ml  
rosca métrica 1,8ml  
E-374-18M

US thread 1,8cc  
US thread 1,8cc  
rosca US 1,8cc  
E-374-18US

metric thread 2,2ml  
hilo métrico 2,2 ml  
rosca métrica 2,2ml  
E-374-22M

US thread 2,2cc  
US thread 2,2cc  
rosca US 2,2cc  
E-374-22US

THREE RING CARTRIDGE SYRINGE  
JERINGA DEL CARTUCHO DE TRES ANILLOS  
TRÉS SERINGAS DE CARTUCHO DE ANEL

metric thread 1,8 ml  
hilo métrico 1,8 ml  
rosca métrica 1,8ml  
E-375-18M

US thread 1,8cc  
US thread 1,8cc  
rosca US 1,8cc  
E-375-18US

metric thread 2,2ml  
hilo métrico 2,2 ml  
rosca métrica 2,2ml  
E-375-22M

US thread 2,2cc  
US thread 2,2cc  
rosca US 2,2cc  
E-375-22US



STAHL, PASSIVE AUTOMATIC ASPIRATION

metric thread 1,8 ml  
 hilo métrico 1,8 ml  
 rosca métrica 1,8ml  
 E-389-18M

US thread 1,8cc  
 US thread 1,8cc  
 rosca US 1,8cc  
 E-389-18US

metric thread 2,2ml  
 hilo métrico 2,2 ml  
 rosca métrica 2,2ml  
 E-389-22M

US thread 2,2cc  
 US thread 2,2cc  
 rosca US 2,2cc  
 E-389-22US

STAHL, PASSIVE AUTOMATIC ASPIRATION

metric thread 1,8 ml  
 hilo métrico 1,8 ml  
 rosca métrica 1,8ml  
 E-390-18M

US thread 1,8cc  
 US thread 1,8cc  
 rosca US 1,8cc  
 E-390-18US

metric thread 2,2ml  
 hilo métrico 2,2 ml  
 rosca métrica 2,2ml  
 E-390-22M

US thread 2,2cc  
 US thread 2,2cc  
 rosca US 2,2cc  
 E-390-22US





Empire



ARTICULATED SYRINGE S-TYPE  
JERINGA ARTICULADA S-TYPE  
SERINGA ARTICULADA S-TYPE

metric thread 1,8 ml  
hilo métrico 1,8 ml  
rosca métrica 1,8ml  
E-378-18M

US thread 1,8cc  
US thread 1,8cc  
rosca US 1,8cc  
E-378-18US

metric thread 2,2ml  
hilo métrico 2,2 ml  
rosca métrica 2,2ml  
E-378-22M

US thread 2,2cc  
US thread 2,2cc  
rosca US 2,2cc  
E-378-22US

AUTOMATIC ASPIRATION SYRINGE  
JERINGA DE ASPIRACIÓN AUTOMÁTICA  
SERINGA DE ASPIRAÇÃO AUTOMÁTICA

metric thread 1,8 ml  
hilo métrico 1,8 ml  
rosca métrica 1,8ml  
E-379-18M

US thread 1,8cc  
US thread 1,8cc  
rosca US 1,8cc  
E-379-18US

metric thread 2,2ml  
hilo métrico 2,2 ml  
rosca métrica 2,2ml  
E-379-22M

US thread 2,2cc  
US thread 2,2cc  
rosca US 2,2cc  
E-379-22US

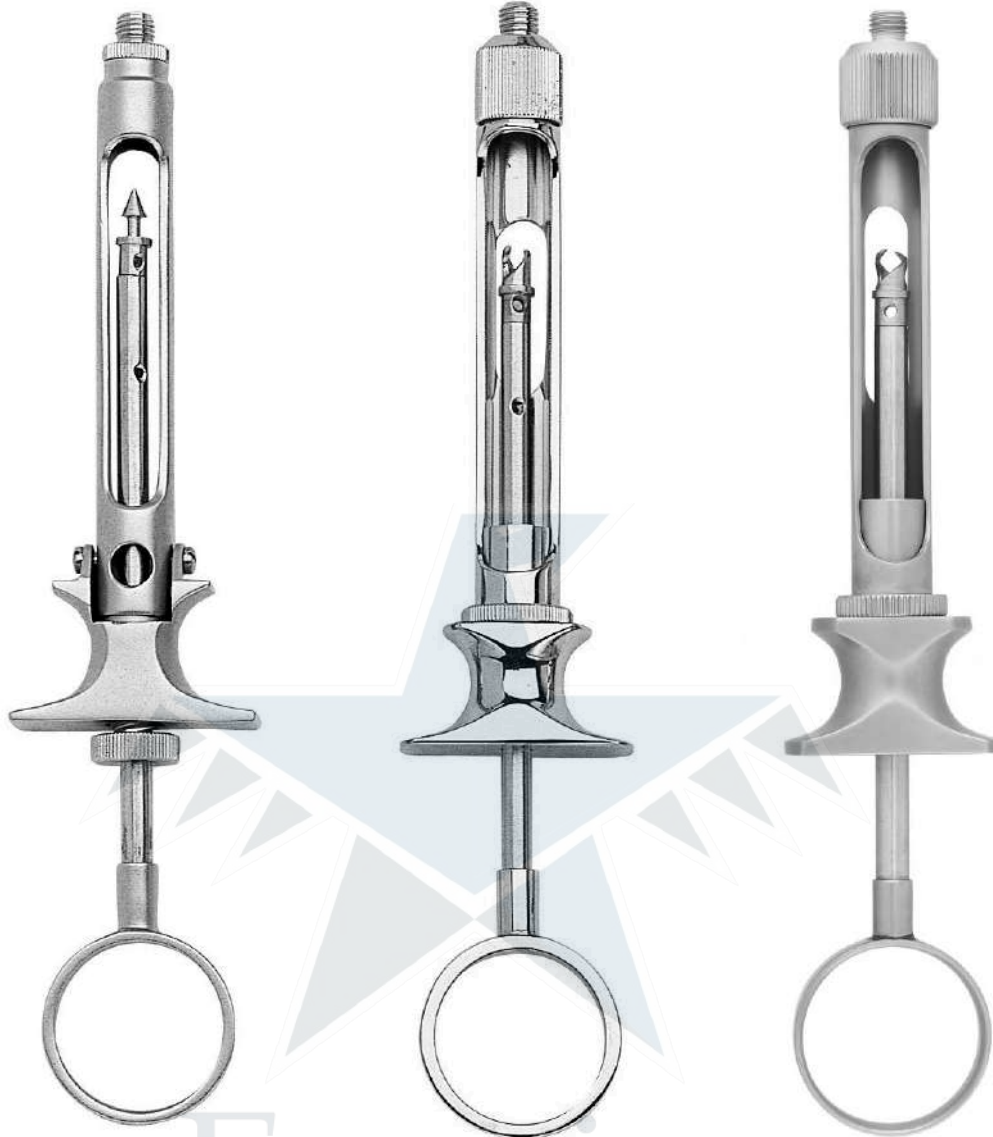

Cook-waite

metric thread 1,8 ml  
hilo métrico 1,8 ml  
rosca métrica 1,8ml  
E-386-18M

US thread 1,8cc  
US thread 1,8cc  
rosca US 1,8cc  
E-386-18US

metric thread 2,2ml  
hilo métrico 2,2 ml  
rosca métrica 2,2ml  
E-386-22M

US thread 2,2cc  
US thread 2,2cc  
rosca US 2,2cc  
E-386-22US

metric thread 1,8 ml  
hilo métrico 1,8 ml  
rosca métrica 1,8ml  
E-387-18M

US thread 1,8cc  
US thread 1,8cc  
rosca US 1,8cc  
E-387-18US

metric thread 2,2ml  
hilo métrico 2,2 ml  
rosca métrica 2,2ml  
E-387-22M

US thread 2,2cc  
US thread 2,2cc  
rosca US 2,2cc  
E-387-22US

metric thread 1,8 ml  
hilo métrico 1,8 ml  
rosca métrica 1,8ml  
E-388-18M

US thread 1,8cc  
US thread 1,8cc  
rosca US 1,8cc  
E-388-18US

metric thread 2,2ml  
hilo métrico 2,2 ml  
rosca métrica 2,2ml  
E-388-22M

US thread 2,2cc  
US thread 2,2cc  
rosca US 2,2cc  
E-388-22US



WITH ASPIRATION DEVICE  
CON DISPOSITIVO DE ASPIRACIÓN  
COM DISPOSITIVO DE ASPIRAÇÃO

metric thread 1,8 ml  
hilo métrico 1,8 ml  
rosca métrica 1,8ml  
E-383-18M

US thread 1,8cc  
US thread 1,8cc  
rosca US 1,8cc  
E-383-18US

metric thread 2,2ml  
hilo métrico 2,2 ml  
rosca métrica 2,2ml  
E-383-22M

US thread 2,2cc  
US thread 2,2cc  
rosca US 2,2cc  
E-383-22US



AMALGAM CARRIER  
AMALGAM CARRIER  
CARREGADOR DE AMALGAM  
E-381-05



INTRALIGAMENTARY SYRINGE  
JERINGA INTRALIGAMENTAL  
SERINGA INTRALIGAMENTAR  
E-380-05



PAROJECT SYRINGE, AUTO  
JERINGUILLA PAROJECT, AUTO  
SERINGA DE PAROJE, AUTO  
E-380-06



AUTOMATIC

AUTOMÁTICO



INTRALIGAMENTAL SYRINGE  
GUN STYLE (AUTOMATIC)  
JERINGA INTRALIGAMENTAL  
ESTILO DE ARMA (AUTOMÁTICA)  
SERINGA INTRALIGAMENTAL  
ESTILO DE ARMA (AUTOMÁTICO)

metric thread 1,8 ml  
metrisches Gewinde 1,8ml  
rosca métrica 1,8ml

E-384-00

INTRALIGAMENTARY SYRINGE  
JERINGA INTRALIGAMENTAL  
SERINGA INTRALIGAMENTAR  
E-380-07



INTRALIGAMENTARY SYRINGE  
JERINGA INTRALIGAMENTAL  
SERINGA INTRALIGAMENTAR  
E-380-08



INTRALIGAMENTARY SYRINGE  
JERINGA INTRALIGAMENTAL  
SERINGA INTRALIGAMENTAR  
E-380-09





## NEEDLE RE-CAPPER AGUJA RE-CAPPER

Empire needle re-capper are the ideal way to prevent needle stick injuries when recapping needles. Place the upturned needle cap into Empire re-capper and re-sheating becomes a simple one hand procedure.

El re-capper de aguja Empire es la manera ideal de prevenir lesiones de needle stick al volver a tapar las agujas. Coloque la tapa de la aguja hacia arriba en Empire re-capper y volver a recubrir se convierte en un simple procedimiento de una mano.

O re-capper da agulha do império é a maneira ideal impedir que o needle fure ferimentos ao reencapar agulhas. Colocar a tampa invertida da agulha no re-capper do império e re-sheating transforma-se um procedimento simples de uma mão.



NEEDLE RE-CAPPER  
AGUJA RE-CAPPER  
AGULHA RE-CAPPER  
E-380-12

Empire

NEEDLE RE-CAPPER  
AGUJA RE-CAPPER  
AGULHA RE-CAPPER  
E-380-13





- IMPRESSION MATERIAL
- MATERIAL DE IMPRESIÓN
- MATERIAL DE IMPRESSÃO



EMPIRE SURGICAL LTD (THE FUTURE OF HEALTHCARE)



## EHRICKE



for toothed lower jaws  
para mandíbulas inferiores dentadas  
para maxilas inferiores dentadas

E-720-BU 0  
E-720-BU 1  
E-720-BU 2  
E-720-BU 3  
E-720-BU 4



for partially toothed lower jaws  
para mandíbulas inferiores parcialmente dentadas  
para maxilas inferiores parcialmente dentadas

E-720-PU 1  
E-720-PU 2  
E-720-PU 3



for edentulous lower jaws  
para mandíbulas inferiores edéntulas  
para mandíbulas desdentadas

E-720-UU 1  
E-720-UU 2  
E-720-UU 3

# EHRICKE



for toothed upper jaws  
para mandíbulas superiores dentadas  
para maxilas superiores dentadas

E-720-BO 0  
E-720-BO 1  
E-720-BO 2  
E-720-BO 3  
E-720-BO 4



for partially toothed upper jaws  
para mandíbulas superiores  
parcialmente dentadas  
para maxilas superiores  
parcialmente dentadas

E-720-PO 1  
E-720-PO 2  
E-720-PO 3

for functional impressions (no picture)  
para impresiones funcionales  
(sin imagen)  
para impressões funcionais  
(sem imagem)

E-720-FO 1  
E-720-FO 2  
E-720-FO 3



for edentulous upper jaws  
para mandíbulas superiores edéntulas  
para mandíbulas superiores desdentadas

E-720-UO 1  
E-720-UO 2  
E-720-UO 3

## EHRICKE

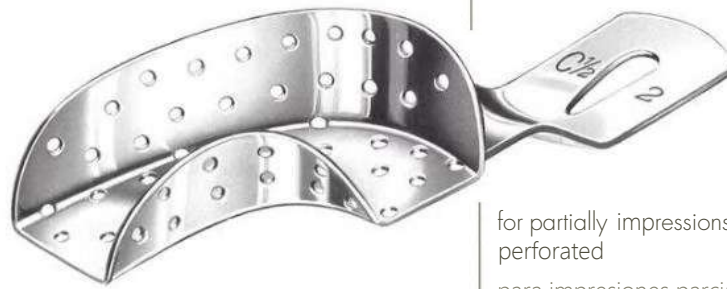

for partially impressions, left  
perforated

para impresiones parciales, izquierda  
perforado  
para impressões parciais, esquerda  
perfurado

E-721-15 L



for partially impressions, left  
unperforated

para impresiones parciales, izquierda  
sin perforar  
para impressões parciais, esquerda  
não perfurado

E-721-16 L

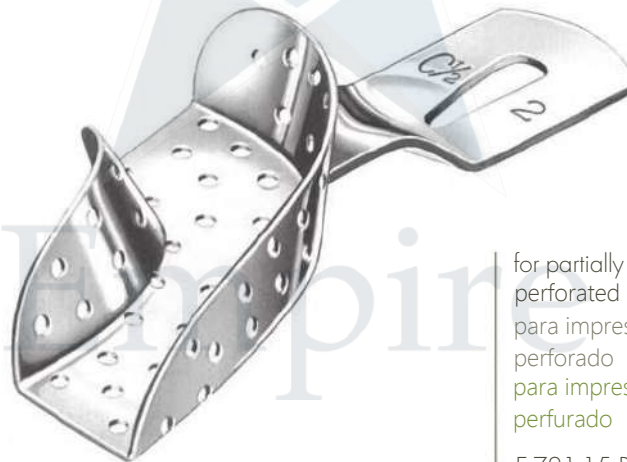

for partially impressions, right  
perforated

para impresiones parciales, derecha  
perforado  
para impressões parciais, certo  
perfurado

E-721-15 R



for partially impressions, right  
unperforated

para impresiones parciales, derecha  
sin perforar  
para impressões parciais, certo  
não perfurado

E-721-16 R

# EHRICKE

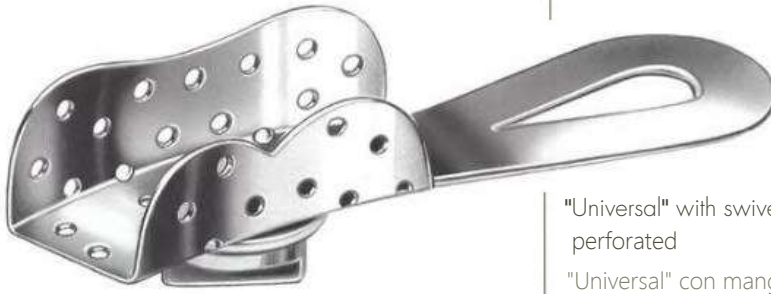

"Universal" with swivel handle and fixing screw perforated  
"Universal" con mango giratorio y tornillo de fijación perforado  
"Universal" com cabo giratório e parafuso de fixação perfurado  
E-721-23



"Universal" with swivel handle and fixing screw unperforated  
"Universal" con mango giratorio y tornillo de fijación sin perforar  
"Universal" com cabo giratório e parafuso de fixação não perfurado  
E-721-24

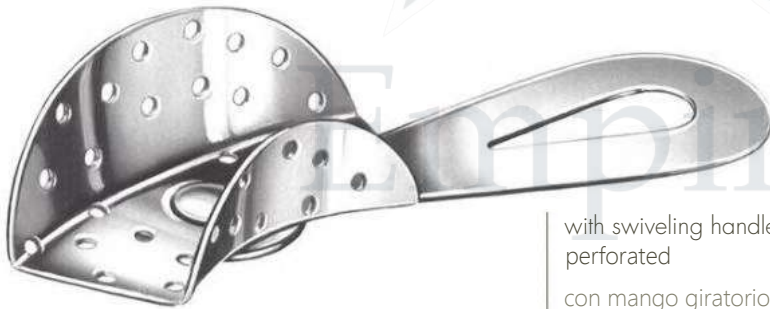

with swiveling handle perforated  
con mango giratorio perforado  
com alça giratória perfurado  
E-721-29



with swiveling handle unperforated  
con mango giratorio sin perforar  
with swiveling handle não perfurado  
E-721-30

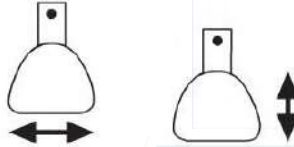

Edged Impression Trays  
upper jaws

Bandejas de impresión con bordes  
mandíbulas superiores

Bandejas de Impressão Afiadas  
maxilas superiores

E-722-00

Oberkiefer upper jaw		mm	mm
E-722-01	XXS/U1A	61	47
E-722-02	XS/U2A	64	51
E-722-03	S/U3A	66	53
E-722-04	M/U4A	69	57
E-722-05	L/U5A	71	60
E-722-06	XL/U6A	73	62

Advantages of the edged  
impression trays

- retention bordering enables very good hold of the alginate
- improved closing edge design
- cheek bands do not press through
- better vestibule shaping
- no adhesive carrier necessary

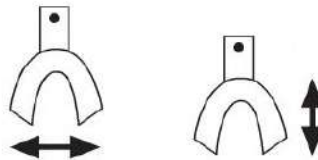

Edged Imperssion Trays  
lower jaws

Bandejas de impresión con bordes  
mandíbulas inferiores

Bandejas de Impressão Afiadas  
mandíbulas inferiores

E-723-00

Unterkiefer lower jaw		mm	mm
E-723-01	XXS/L1	55	47
E-723-02	XS/L2	60	49
E-723-03	S/L3	72	54
E-723-04	M/L4	75	57
E-723-05	L/L5	76	59
E-723-06	XL/L6	78	61

Ventajas de los afilados  
bandejas de impresión

- la retención de bordes permite buen agarre del alginato
- diseño de borde de cierre mejorado
- bandas de mejilla no presionan a través de
- mejor forma del vestíbulo
- no es necesario un soporte adhesivo



- IMPLANTOLOGY
- IMPLANTOLOGÍA
- IMPLANTOLOGIA



EMPIRE SURGICAL LTD (THE FUTURE OF HEALTHCARE)





Bone Scraper, straight of stainless steel  
 Raspador de huesos, recto de acero inoxidable  
 raspador de hueso, reto de aço inoxidável  
 [ 155 mm  
 E-800-01  
 Spare blade straight  
 Cuchilla de repuesto recta  
 Lâmina de reposição em linha reta  
 E-800-01A

Bone Scraper, curved of stainless steel  
 Raspador de hueso, curvado de acero inoxidable  
 Raspador Ósseo, curvado de aço inoxidável  
 [ 155 mm  
 E-800-02  
 Spare blade, curved  
 Hoja de repuesto, curva  
 Lâmina de reposição em linha curvado  
 E-800-02A

Bone Plugger with Titanium Tips  
 Knochenstopfer mit Arbeitseisen aus Titan

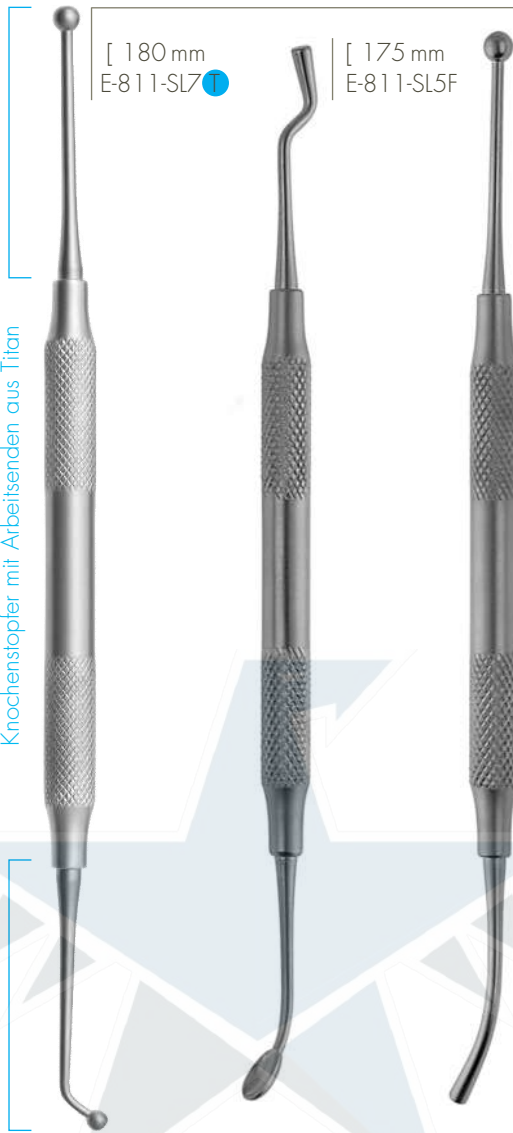

[ 180 mm  
 E-811-SL7

[ 175 mm  
 E-811-SL5F

[ 175 mm  
 E-811-SL6F

COMPACTOR

Compactors to place or compress bone substitute or autologous bone material.

STOPPER

Stopfer zum Einbringen und Verdichten von Knochenaufbaumaterial bzw. autologem Knochen.

BONE SCRAPER

The bone scraper enables you to scrape, collect and transplant the patient's own bone. The bone is collected in a chamber during the scraping and at the same time the bone is being mixed with blood. The bone material can be implanted directly out of the bone scraper which has been sterilized before. The blade should be replaced after 30 applications.

Raspador de huesos

El raspador de huesos te permite raspar, recoger y trasplantar el propio paciente hueso. El hueso se recoge en una cámara durante el raspado y al mismo tiempo el hueso se está mezclando con sangre. El hueso el material puede ser implantado directamente fuera de el raspador de hueso que ha sido esterilizado antes de. La cuchilla debe ser reemplazada después 30 aplicaciones.



SUCTION TUBES  
to collect the extracted  
material óseo

TUBOS DE SUCCIÓN  
para recoger el extraído  
des gewonnenen  
Knochenmaterials

TUBOS DE SUCCÃO  
para coletar o extraído  
material ósseo

coarse  
grob  
grosseiro

[ 180 mm  
Ø 5 mm  
E-806-20

fine  
fein  
bem

Ø 9 mm  
E-806-21



BONE APPLICATOR  
to insert the extracted  
bone compound

APLICADOR DE HUESO  
para insertar el extraído  
bone compound

APLICADOR DE OSSO  
para inserir o extraído  
composto ósseo

Ø 2,5 mm / 3,5 mm  
[ 170 mm  
E-806-01

Ø 3,5 mm / 4,5 mm  
[ 170 mm  
E-806-02

Ø 4,5 mm / 5,5 mm  
[ 170 mm  
E-806-03

Ø 6,0 mm / 7,0 mm  
[ 170 mm  
E-806-04

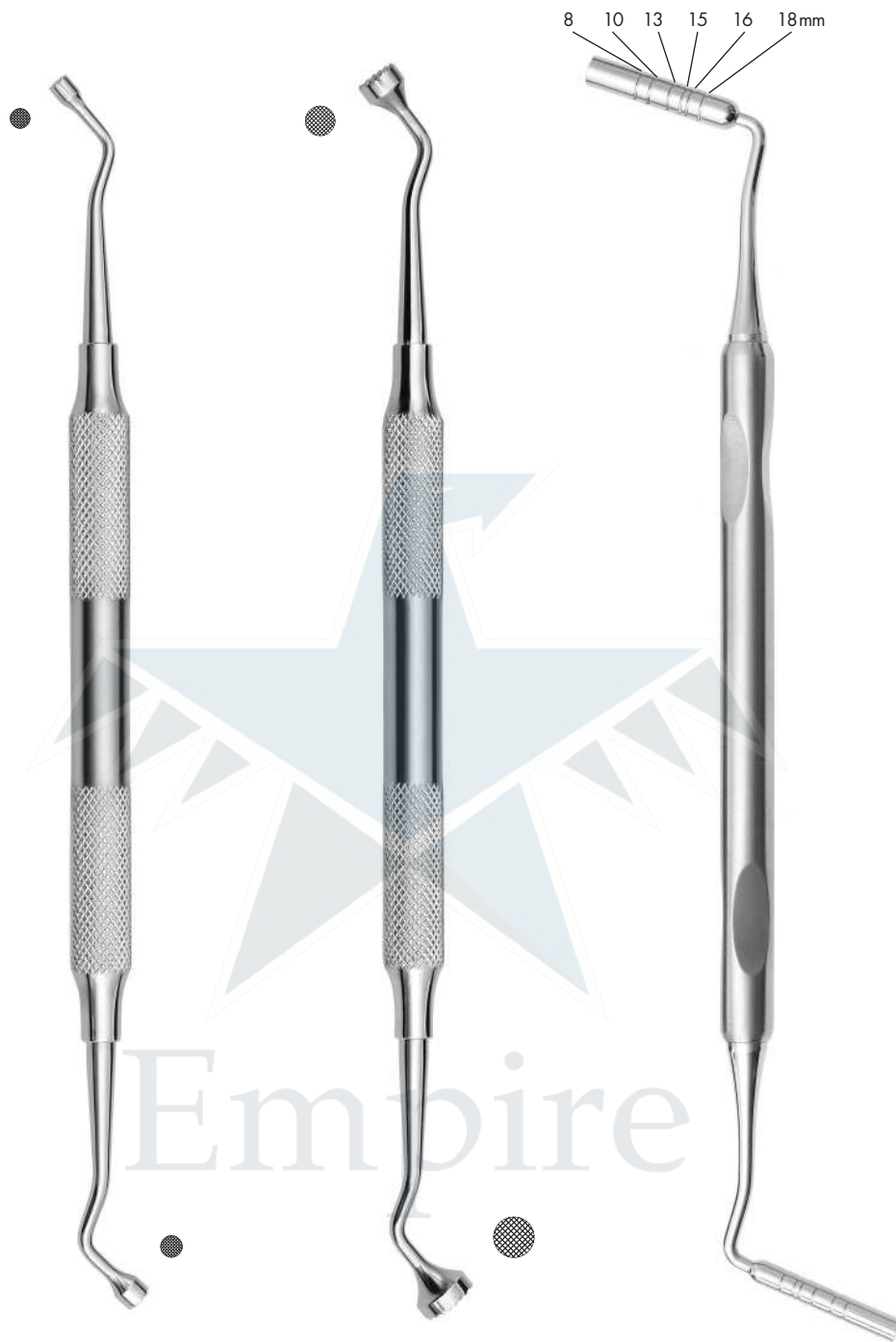

Compactor  
Compactador  
Compactador  
[ 170 mm  
E-401-C1

Compactor  
Compactador  
Compactador  
[ 170 mm  
E-401-C2

Granulate Plugger  
Compactador  
Plugger de granulado  
[ 190mm, Ø3,5/4,5mm  
E-335-02

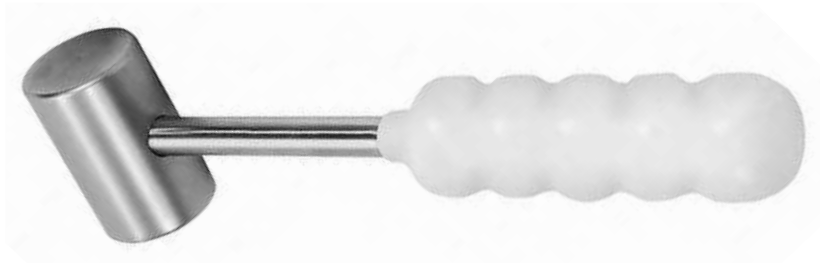

Titanium  
Titanio



Titanium  
Titanio

Stainless steel  
Acero inoxidable

EASY BONE  
Manual Bone Mill  
to chop bone fragments  
Manual Bone Mill  
para cortar fragmentos  
de hueso  
FÁCIL OSSO  
Moinho de Ossos Manual  
cortar fragmentos de osso  
E-900-05

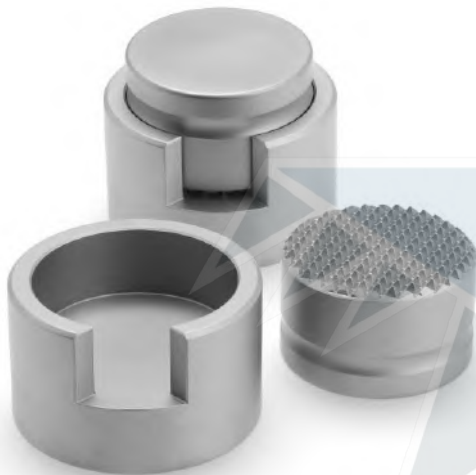

BONE CRUSHER  
to chop bone fragments  
cortar fragmentos de hueso  
cortar fragmentos de osso

50 X 40 mm  
E-900-06



AMALGAM AND BONE WELL  
to chop bone fragments  
cortar fragmentos de hueso  
cortar fragmentos de osso

25 X 30mm  
E-900-07



Bone Mill with  
Titanium Grinding Gear  
Engranaje de  
rectificado de titanio  
Moinho de Ossos com  
Engrenagem De Moedura  
De Titânio  
[175 mm  
E-900-08



Empire



tissue punches, straight  
golpes de tejido, recto  
punções de tecido, reto  
80 x 5.0 mm  
E-941-05

[ 80 x 6.0 mm  
E-941-06

tissue punches, straight  
golpes de tejido, recto  
punções de tecido, reto  
[ 100 x 4.0 mm  
E-941-04

tissue punches, angled  
golpes de tejido, en ángulo  
punções de tecido, angulado  
[ 80 x 5.0 mm  
E-940-05

[ 80 x 6.0 mm  
E-940-06

tissue punches, angled  
golpes de tejido, en ángulo  
punções de tecido, angulado  
[ 100 x 4.0 mm  
E-940-04





ARNHOLD  
Bone holding plier, curved  
Alicates de sujeción de huesos, curvados  
alicate de preensão de osso, curvado  
[ 200 mm  
E-801-04

ARNHOLD  
Bone holding plier, curved  
Alicates de sujeción de huesos, curvados  
alicate de preensão de osso, curvado  
[ 220 mm  
E-801-09

ARNHOLD  
Bone holding plier  
Alicates de sujeción de huesos,  
alicate de preensão de osso  
[ 220 mm  
E-801-10

Empire







SMITH-RAMUS  
Bone Spreader  
Esparcidor de hueso  
Espalhador de Ossos  
[ 235mm  
E-801-33



ARNOLD  
Bone Graft Holding  
and Drilling Forceps  
ARNHOLD  
injerto de hueso  
y fórceps de perforación  
Fórceps de retenção e perfuração  
de enxerto ósseo  
[ 200mm  
E-801-12



ARNOLD angled  
Bone Graft Holding  
and Drilling Forceps  
ARNHOLD gewinkelt  
injerto de hueso  
y fórceps de perforación  
Fórceps de retenção e perfuração  
de enxerto ósseo  
[ 200mm  
E-802-13

# TITANIUM TITANIO



NEWDESIGN Titanium Curettes with extremely light handle and tips made of Titanium especially applicable to clean implants. By using Titanium for the tips, a damage of the surface of the implants will be avoided. The L-Light Titanium Curettes are currently available in 5 different pattern.

NUEVO DISEÑO Curetas de titanio con mango extremadamente ligero y puntas hechas de Titanio especialmente aplicable para limpiar implantes. Al usar titanio para las puntas un daño de la superficie de los implantes será evitado El titanio L-Light Las curetas están actualmente disponibles en 5 patrón diferente

Following pattern also available (no picture):  
Folgende Ausführungen auch verfügbar (ohne Abbildung):

COLUMBIA 2RL = 401/2RL-ED

COLUMBIA 4RL = 401/4RL-ED

E-401-L5/6-ED  
Langer Kürette Fig.5-6

E-401-L3/4-ED  
Langer Kürette Fig.3-4

E-401-L1/2-ED  
Langer Kürette Fig.1-2

E-401-H6H7-ED  
Universal Scaler H6/H7

E-401-204SD-ED  
Universal Scaler 204SD

MEASURING GAUGE

MESSEHRE  
0 – 10cm  
E-800-05

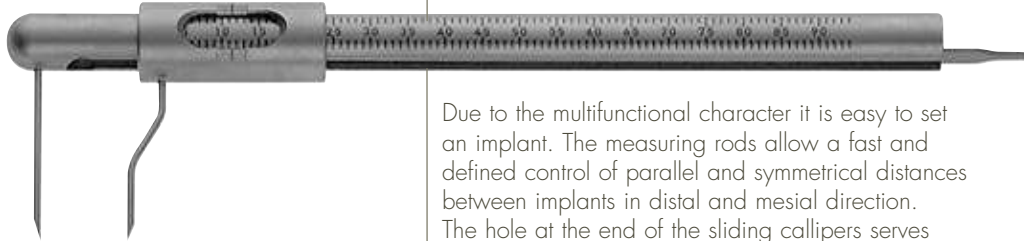

Due to the multifunctional character it is easy to set an implant. The measuring rods allow a fast and defined control of parallel and symmetrical distances between implants in distal and mesial direction. The hole at the end of the sliding callipers serves as a drilling gauge, drilling guide and depth measurement.

Debido al carácter multifuncional, es fácil de configurar un implante. Las barras de medición permiten un rápido y control definido de distancias paralelas y simétricas entre implantes en dirección distal y mesial. El orificio al final de las pinzas deslizantes sirve como un medidor de perforación, guía de perforación y profundidad medición.

PARALLEL DRILLING GUIDE:

By tightening the fixing screw of this drilling guide it is being ensured to keep the exact distance while setting the implants.

GUÍA DE PERFORACIÓN PARALELA:

Al apretar el tornillo de fijación de esta guía de perforación está siendo asegurada para mantener la distancia exacta mientras colocando los implantes.

with 2,0mm drilling hole  
con agujero de perforación de 2,0 mm  
E-800-51

with 2,5mm drilling hole  
con agujero de perforación de 2,5 mm  
E-800-51/25



BONE MEASURING CALIPPER

for measuring the bone width, scale on both sides 0-25mm  
para medir el ancho del hueso, escalar  
en ambos lados 0-25 mm  
E-800-54

CASTROVIEJO CALIPERS  
PINZAS CASTROVIEJO  
CALIPERS CASTROVIEJO  
20mm, [ 90mm  
E-215-06



CASTROVIEJO CALIPERS  
PINZAS CASTROVIEJO  
CALIPERS CASTROVIEJO  
20mm, 45°, [ 90mm  
E-215-07



CASTROVIEJO CALIPERS  
PINZAS CASTROVIEJO  
CALIPERS CASTROVIEJO  
20mm, [ 90mm  
E-215-08



ZURICHER CALIPERS  
 PINZAS ZURICHER  
 CALÇAS ZURICHER  
 [ 130mm  
 E-215-14

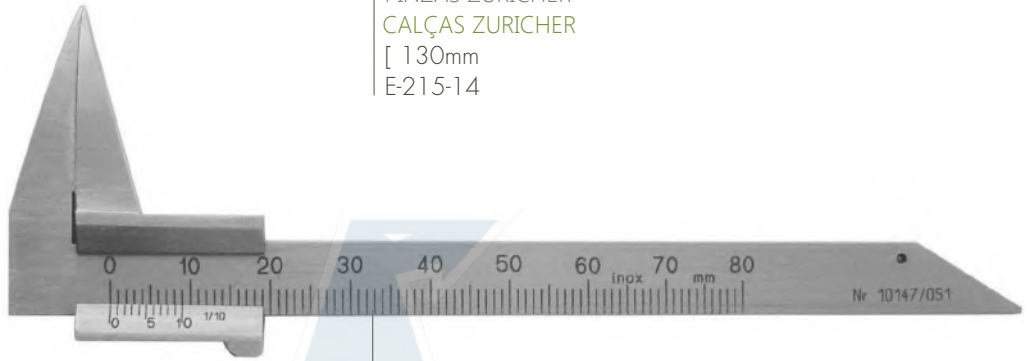

BEERENDONK CALIPERS  
 PINZAS BEERENDONK  
 CALIBRAS BEERENDONK  
 [ 130mm  
 E-215-15

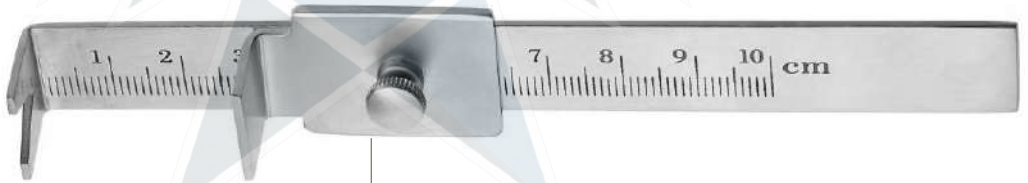

SLIDING CALIPERS  
 PINZAS DESLIZANTES  
 CALÇAS DESLIZANTES  
 [ 130mm  
 E-215-18



BOLEY CALIPERS  
 PINZAS BOLEY  
 CALÇAS DE BOLEY  
 [ 145mm  
 E-215-20



RULER  
 REGLA  
 RÉGUA  
 [ 150mm  
 E-215-29

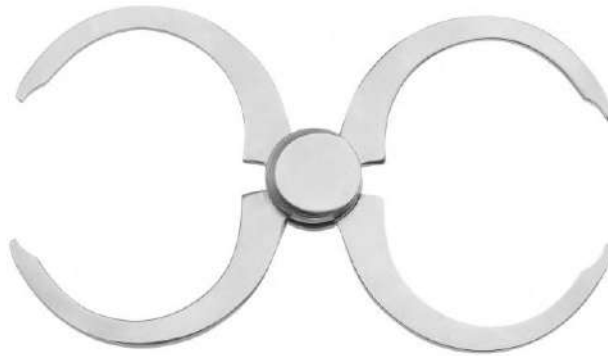

COMPASS CALIPER  
 PINZA DE COMPÁS  
 COMPASSO DE CALIBRE  
 E-215-12



IWANSON CALIPER  
 for wax  
 IWANSON CALIPER, para la cera  
 CALÇAS IWANSON, para cera  
 [ 100mm  
 E-215-09

IWANSON CALIPER  
 for metal  
 IWANSON CALIPER, para metal  
 CALÇAS IWANSON, para metal  
 [ 100mm  
 E-215-10





Implant Holding Tweezers  
self locking, made of Titanium  
Pinzas de sujeción de implantes  
autobloqueante, hecho de titanio  
Pinças de sujeción de implantes  
auto travamento, feito de titânio

[ 160mm  
E-184-50 **T**

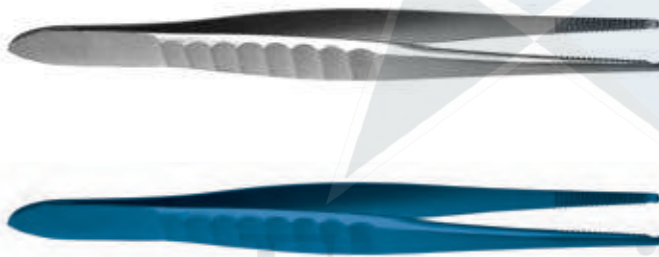

Holding Tweezers for Implants  
Pinzas de sujeción para implantes  
Segurando Pinças para Implants

[ 130mm  
E-184-51

dito / Titanium / Titânio  
E-184-51 **T**



Holding Tweezers for Implants  
Pinzas de sujeción para implantes  
Segurando Pinças para Implants

[ 100mm  
E-184-52

dito / Titanium / Titânio  
E-184-52 **T**



articulating paper Tweezers  
pinzas de papel articuladas  
pinça de papel articulada  
[ 155mm  
E-184-55



articulating paper Tweezers  
pinzas de papel articuladas  
pinça de papel articulada  
[ 155mm  
E-184-56



soldering Tweezers  
Pinzas de soldadura  
pinça de solda  
[ 165mm  
E-184-59



soldering Tweezers  
Pinzas de soldadura  
pinça de solda  
[ 160mm  
E-184-60

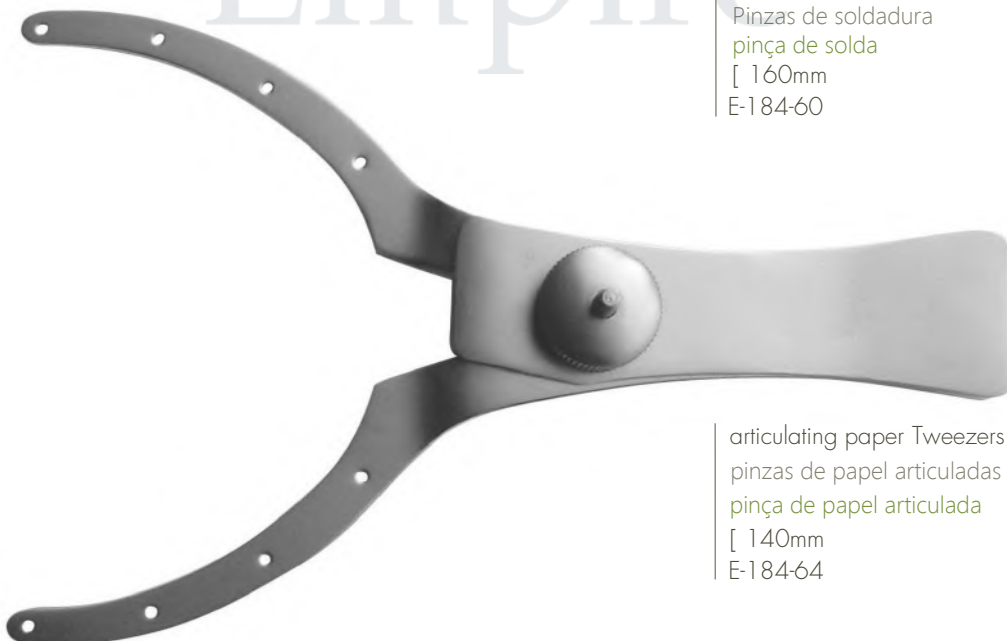

articulating paper Tweezers  
pinzas de papel articuladas  
pinça de papel articulada  
[ 140mm  
E-184-64



Empire



bone scraper, angular  
raspador de hueso, angular  
raspador óseo angular  
150 mm  
E-800-11



bone scraper, straight  
raspador de hueso, recto  
raspador de osso, reto  
155 mm  
E-800-12



blade, angular  
blade, angular  
lâmina angular  
155 mm  
E-800-20



bone scoop, 155mm  
cucharada de hueso, 155 mm  
colher de osso  
155 mm  
E-800-17



bone scoop  
cucharada de hueso  
colher de osso  
155 x5.0 mm  
E-800-14



bone scoop and spatula  
cuchara de hueso y espátula  
colher de osso  
180 mm  
E-800-13



bone scoop and plugger  
cucharada de hueso y plugger  
colher de osso  
E-800-18

# SINUS LIFT CURETTES FLEXIBLE CURVAS DE ELEVACIÓN SINUS FLEXIBLES

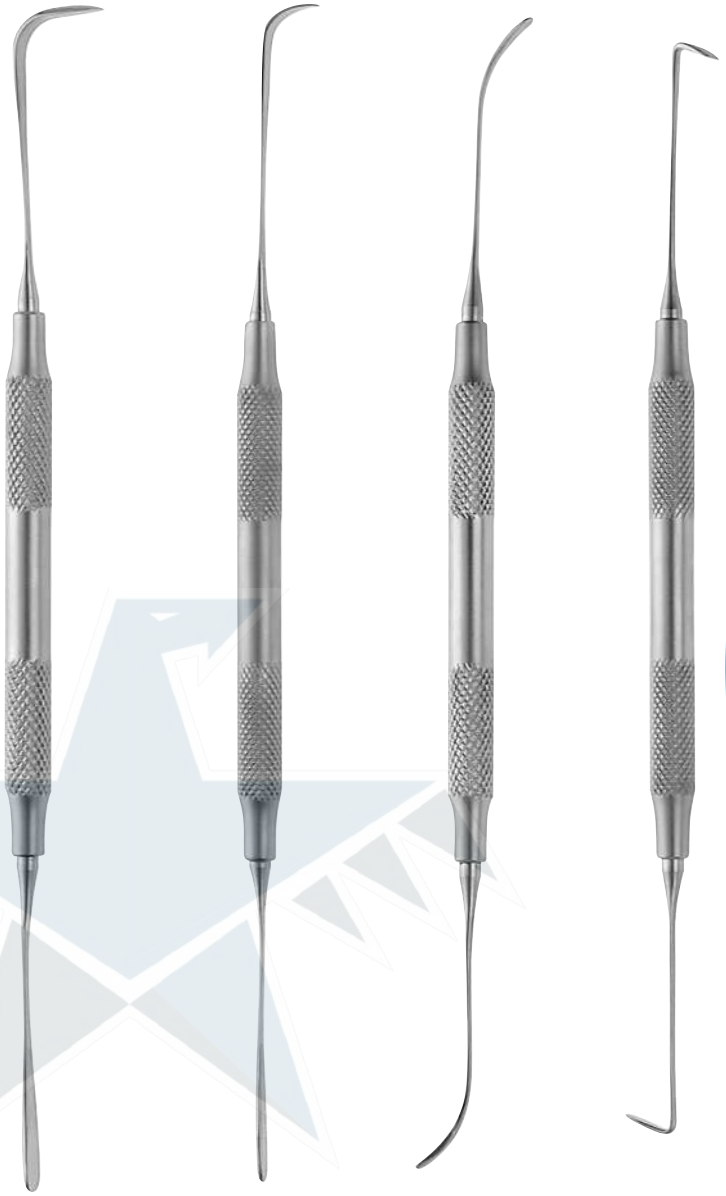

E-811-SL1F

E-811-SL2F

E-811-SL3F

E-811-SL4F

These new Sinus Lift instrument set for the direct sinus lift increases the sensitivity during operation and reduces the risk of perforating the „Schneider’sche membrane” – due to the unique swing-effect.

El nuevo conjunto de instrumentos Sinus Lift para la elevación del seno directo aumenta la sensibilidad durante el funcionamiento y reduce el riesgo de perforar el "Schneider'sche membrane": debido al efecto swing único.



Tray suitable for flexible Sinus Lift and Accessories

Bandeja adecuada para elevación y accesorios sinusales flexibles  
274 x 80 x 41mm

E-500-04





blunt  
embotar  
contundente  
[ 190 mm  
E-810-SL1



blunt  
embotar  
contundente  
[ 190 mm  
E-810-SL2

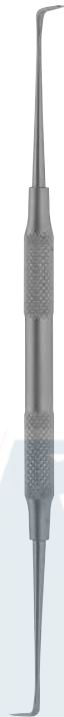

blunt  
embotar  
contundente  
[ 190 mm  
E-810-SL3



blunt  
embotar  
contundente  
[ 190 mm  
E-810-SL4



blunt  
embotar  
contundente  
[ 190 mm  
E-810-SL5



[ 170 mm  
E-810-SL11



[ 170 mm  
E-810-SL12



[ 170 mm  
E-810-SL13



blunt  
embotar  
contundente  
[ 190mm  
E-810-SL6



blunt  
embotar  
contundente  
[ 190mm  
E-810-SL7



blunt  
embotar  
contundente  
[ 190mm  
E-810-SL8



blunt  
embotar  
contundente  
[ 190mm  
E-810-SL9



blunt  
embotar  
contundente  
[ 190mm  
E-810-SL10



[ 170mm  
E-810-SL14



[ 170mm  
E-810-SL15

Empire



## BONE SPREADING SYSTEM

## SISTEMA DE ESPARCIMIENTO ÓSEA



Universal applicable Instrument System to locally enlarge the bones before the implantation.

Instrumento universal aplicable Sistema para ampliar localmente los huesos antes de la implantación.

- » also available with NEWDESIGN Handle
- » También disponible con mango NUEVO DISEÑO

NEW with color identification for more safety and effectiveness!  
 NUEVO con identificación de color para más seguridad y efectividad!

2,2mm	●	[ 170 mm
2,8mm	●	E-816-22
3,4mm	●	E-816-28
4,0mm	●	E-816-34
		E-816-40

[ 170mm
E-817-22
E-817-28
E-817-34
E-817-40

INSTRUMENTS WITH NEWDESIGN HANDLE

- New shape for comfortable and non-exhausting working even over a long period
- Safe grip even during working with wet hands or gloves because of the special serration
- Modern and shapely design
- Easy cleaning
- Available for sinus lift currettes, chisels and osteotomes

INSTRUMENTOS CON MANGO DE NUEVO DISEÑO

- Forma new para cómodo y trabajo no agotador incluso durante un largo período
- Agarre seguro incluso durante el trabajo con manos mojadas o guantes debido a la serrado especial
- Diseño moderno y bien proporcionado
- Limpieza fácil
- Disponible para curetas de elevación sinusal, cinceles y osteótomos



straight  
Derecho  
reto  
4,0 mm, [ 170 mm  
E-812-01  
7,5 mm, [ 170 mm  
E-812-03  
curved  
gebogen  
curvo  
4,0 mm, [ 170 mm  
E-812-02  
7,5 mm, [ 170 mm  
E-812-04



straight  
Derecho  
reto  
4,0 mm, [ 170 mm  
E-815-01  
7,5 mm, [ 170 mm  
E-815-03  
curved  
gebogen  
curvo  
4,0 mm, [ 170 mm  
E-815-02  
7,5 mm, [ 170 mm  
E-815-04

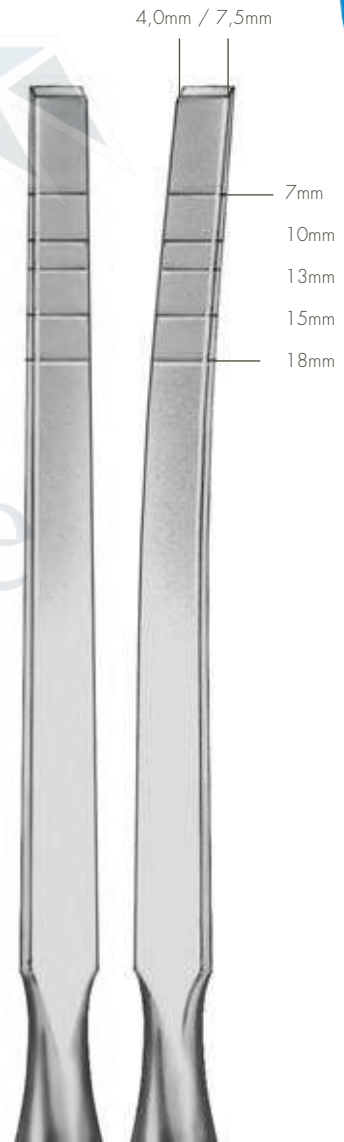

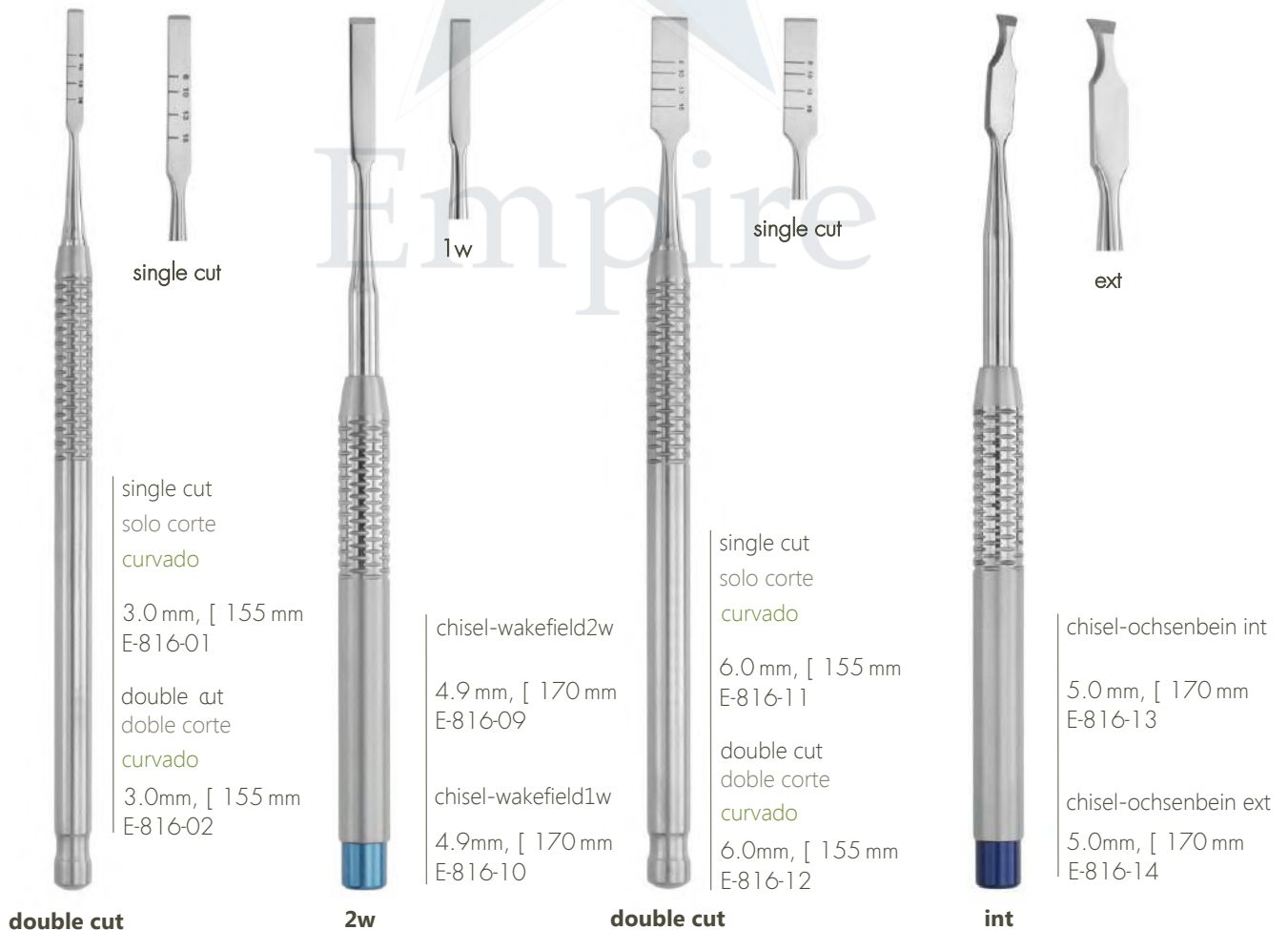
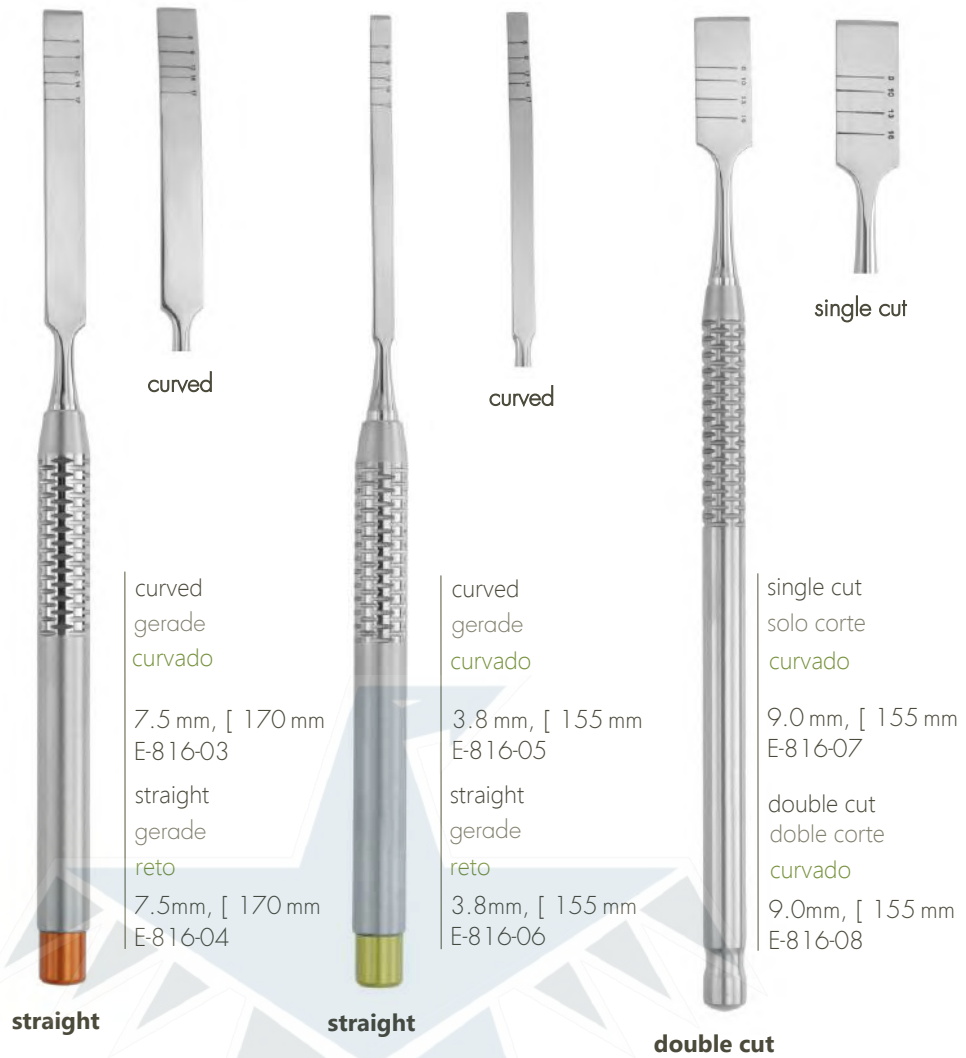

chisel-partsch

3.0 mm, [ 170 mm  
E-816-18

4.0mm, [ 170 mm  
E-816-19

5.0 mm, [ 170 mm  
E-816-20

6.0mm, [ 170 mm  
E-816-21



chisel-partsch

3.0 mm, [ 140 mm  
E-865-22

4.0mm, [ 140 mm  
E-816-23

5.0 mm, [ 140 mm  
E-816-24

6.0mm, [ 140 mm  
E-816-25



chisel-partsch round

3.0 mm, [ 170 mm  
E-816-26

4.0mm, [ 170 mm  
E-816-27

5.0 mm, [ 170 mm  
E-816-28

6.0mm, [ 170 mm  
E-816-29



chisel-partsch round

3,0 mm, [ 140 mm  
E-816-30

4.0mm, [ 140 mm  
E-816-31

5.0 mm, [ 140 mm  
E-816-31

6.0mm, [ 140 mm  
E-816-33



# ERGODESIGN



E-840-20	∅ 2,0mm [ 160mm
E-840-27	∅ 2,7mm [ 160mm
E-840-32	∅ 3,2mm [ 160mm
E-840-37	∅ 3,7mm [ 160mm
E-840-42	∅ 4,2mm [ 160mm
E-840-50	∅ 5,0mm [ 160mm
E-840-60	∅ 6,0mm [ 160mm

E-841-20	∅ 2,0mm [ 160mm
E-841-27	∅ 2,7mm [ 160mm
E-841-32	∅ 3,2mm [ 160mm
E-841-37	∅ 3,7mm [ 160mm
E-841-42	∅ 4,2mm [ 160mm
E-841-50	∅ 5,0mm [ 160mm
E-841-60	∅ 6,0mm [ 160mm

E-842-20	∅ 2,0mm [ 160mm
E-842-27	∅ 2,7mm [ 160mm
E-842-32	∅ 3,2mm [ 160mm
E-842-37	∅ 3,7mm [ 160mm
E-842-42	∅ 4,2mm [ 160mm
E-842-50	∅ 5,0mm [ 160mm
E-842-60	∅ 6,0mm [ 160mm



E-843-20	∅ 2,0mm [ 175mm
E-843-27	∅ 2,7mm [ 175mm
E-843-32	∅ 3,2mm [ 175mm
E-843-37	∅ 3,7mm [ 175mm
E-843-42	∅ 4,2mm [ 175mm
E-843-50	∅ 5,0mm [ 175mm
E-843-60	∅ 6,0mm [ 175mm

E-844-20	∅ 2,0mm [ 175mm
E-844-27	∅ 2,7mm [ 175mm
E-844-32	∅ 3,2mm [ 175mm
E-844-37	∅ 3,7mm [ 175mm
E-844-42	∅ 4,2mm [ 175mm
E-844-50	∅ 5,0mm [ 175mm
E-844-60	∅ 6,0mm [ 175mm

E-845-20	∅ 2,0mm [ 175mm
E-845-27	∅ 2,7mm [ 175mm
E-845-32	∅ 3,2mm [ 175mm
E-845-37	∅ 3,7mm [ 175mm
E-845-42	∅ 4,2mm [ 175mm
E-845-50	∅ 5,0mm [ 175mm
E-845-60	∅ 6,0mm [ 175mm



- E-848-20    Ø 2,0mm [ 160mm
- E-848-27    Ø 2,7mm [ 160mm
- E-848-32    Ø 3,2mm [ 160mm
- E-848-37    Ø 3,7mm [ 160mm
- E-848-42    Ø 4,2mm [ 160mm
- E-848-50    Ø 5,0mm [ 160mm

- E-849-20    Ø 2,0mm [ 160mm
- E-849-27    Ø 2,7mm [ 160mm
- E-849-32    Ø 3,2mm [ 160mm
- E-849-37    Ø 3,7mm [ 160mm
- E-849-42    Ø 4,2mm [ 160mm
- E-849-50    Ø 5,0mm [ 160mm



- E-851-20    Ø 2,0mm [ 175mm
- E-851-27    Ø 2,7mm [ 175mm
- E-851-32    Ø 3,2mm [ 175mm
- E-851-37    Ø 3,7mm [ 175mm
- E-851-42    Ø 4,2mm [ 175mm
- E-851-50    Ø 5,0mm [ 175mm

- E-852-20    Ø 2,0mm [ 175mm
- E-852-27    Ø 2,7mm [ 175mm
- E-852-32    Ø 3,2mm [ 175mm
- E-852-37    Ø 3,7mm [ 175mm
- E-852-42    Ø 4,2mm [ 175mm
- E-852-50    Ø 5,0mm [ 175mm

ERGODESIGN

SINUS LIFT ELEVATORS    IMPLANTOLOGY

IMPLANTOLOGÍA  
ELEVADORES DE ELEVACIÓN SINUS





- E-820-27    Ø 2,7mm [ 160mm
- E-820-32    Ø 3,2mm [ 160mm
- E-820-37    Ø 3,7mm [ 160mm
- E-820-42    Ø 4,2mm [ 160mm
- E-820-50    Ø 5,0mm [ 160mm

- E-823-27    Ø 2,7mm [ 160mm
- E-823-32    Ø 3,2mm [ 160mm
- E-823-37    Ø 3,7mm [ 160mm
- E-823-42    Ø 4,2mm [ 160mm
- E-823-50    Ø 5,0mm [ 160mm



- E-821-27    Ø 2,7mm [ 160mm
- E-821-32    Ø 3,2mm [ 160mm
- E-821-37    Ø 3,7mm [ 160mm
- E-821-42    Ø 4,2mm [ 160mm
- E-821-50    Ø 5,0mm [ 160mm

- E-824-27    Ø 2,7mm [ 160mm
- E-824-32    Ø 3,2mm [ 160mm
- E-824-37    Ø 3,7mm [ 160mm
- E-824-42    Ø 4,2mm [ 160mm
- E-824-50    Ø 5,0mm [ 160mm



with stop and adjusting screw  
 con tope y tornillo de ajuste  
 com parafuso de parada e ajuste

E-833-27	∅ 2,7mm [ 160mm
E-833-32	∅ 3,2mm [ 160mm
E-833-37	∅ 3,7mm [ 160mm
E-833-42	∅ 4,2mm [ 160mm
E-833-50	∅ 5,0mm [ 160mm

E-831-27	∅ 2,7mm [ 160mm
E-831-32	∅ 3,2mm [ 160mm
E-831-37	∅ 3,7mm [ 160mm
E-831-42	∅ 4,2mm [ 160mm
E-831-50	∅ 5,0mm [ 160mm



with stop and adjusting screw  
 con tope y tornillo de ajuste  
 com parafuso de parada e ajuste

E-832-27	∅ 2,7mm [ 160mm
E-832-32	∅ 3,2mm [ 160mm
E-832-37	∅ 3,7mm [ 160mm
E832-42	∅ 4,2mm [ 160mm
E-832-50	∅ 5,0mm [ 160mm

E-830-27	∅ 2,7mm [ 160mm
E-830-32	∅ 3,2mm [ 160mm
E-830-37	∅ 3,7mm [ 160mm
E-830-42	∅ 4,2mm [ 160mm
E-830-50	∅ 5,0mm [ 160mm

E-328-02  
 Bone Crusher  
 Rompe huesos  
 Triturador De Osso



Knochenaufnahmebereich bone receptacle  
 Receptáculo óseo Knochenaufnahmebereich

The harvested bone is put into the crusher and the pestle is used to crush it. Where necessary, you may crush the bone using an additional hammer stroke. The inner diameter of the bone receptacle is 40 mm.

El hueso cosechado se pone en la trituradora y the pestle se usa para aplastarlo. Dónde necesario, puedes aplastar el hueso usando un Golpe de martillo. El interior el diámetro del receptáculo óseo es de 40 mm.

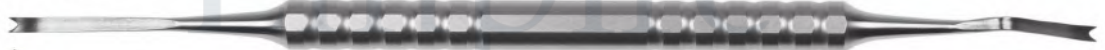

E-803-14  
 For the extraction of the bone cylinder milled with a trephine drill  
 Para la extracción del cilindro de hueso molido con un trépano.  
 Para a extração do cilindro ósseo fresado com broca trefina



TREPHINE DRILLS WITH INTERNAL COOLING

TALADRADORES CON ENFRIAMIENTO INTERNO



1/4

E-808-08  
i=2mm  
a=3mm



1/4

E-808-10  
i=3mm  
a=4mm



1/4

E-808-12  
i=4mm  
a=5mm



1/4

E-808-14  
i=5mm  
a=6mm



1/4

E-808-16  
i=6mm  
a=7mm



1/4

E-808-18  
i=7mm  
a=8mm



1/4

E-808-20  
i=8mm  
a=9mm



1/4

E-808-22  
i=9mm  
a=10mm



2-4-6-8 mm

i = Ø innen, a = Ø außen  
i = Ø internal, a = Ø external



Empire



Trephines drills with internal cooling

Trephines perfora con enfriamiento interno

Brocas Trefinas com refrigeração interna

E-808-08	Ø 2,0 / 3,0mm
E-808-10	Ø 3,0 / 4,0mm
E-808-12	Ø 4,0 / 5,0mm
E-808-14	Ø 5,0 / 6,0mm
E-808-16	Ø 6,0 / 7,0mm
E-808-18	Ø 7,0 / 8,0mm
E-808-20	Ø 8,0 / 9,0mm
E-808-22	Ø 9,0 / 1,0mm





Papilla elevator  
Elevador Papilla  
Elevador papilla  
[ 170mm  
E-335-PH1



GLICKMAN  
E-335-24GSP/ED



BUSER  
[ 170mm  
E-335-B1/ED



Placement Instrument Instrumento de colocación Instrumento de Colocação

[ 175mm  
E-335-MPI



ORBAN 1-2  
E-401-KO12



RHODES BACK-ACTION  
E-401-RBA



CALCIUM HYDROXIDE PLACEMENT INSTRUMENTS  
INSTRUMENTOS DE COLOCACIÓN DE HIDRÓXIDO DE CALCIO

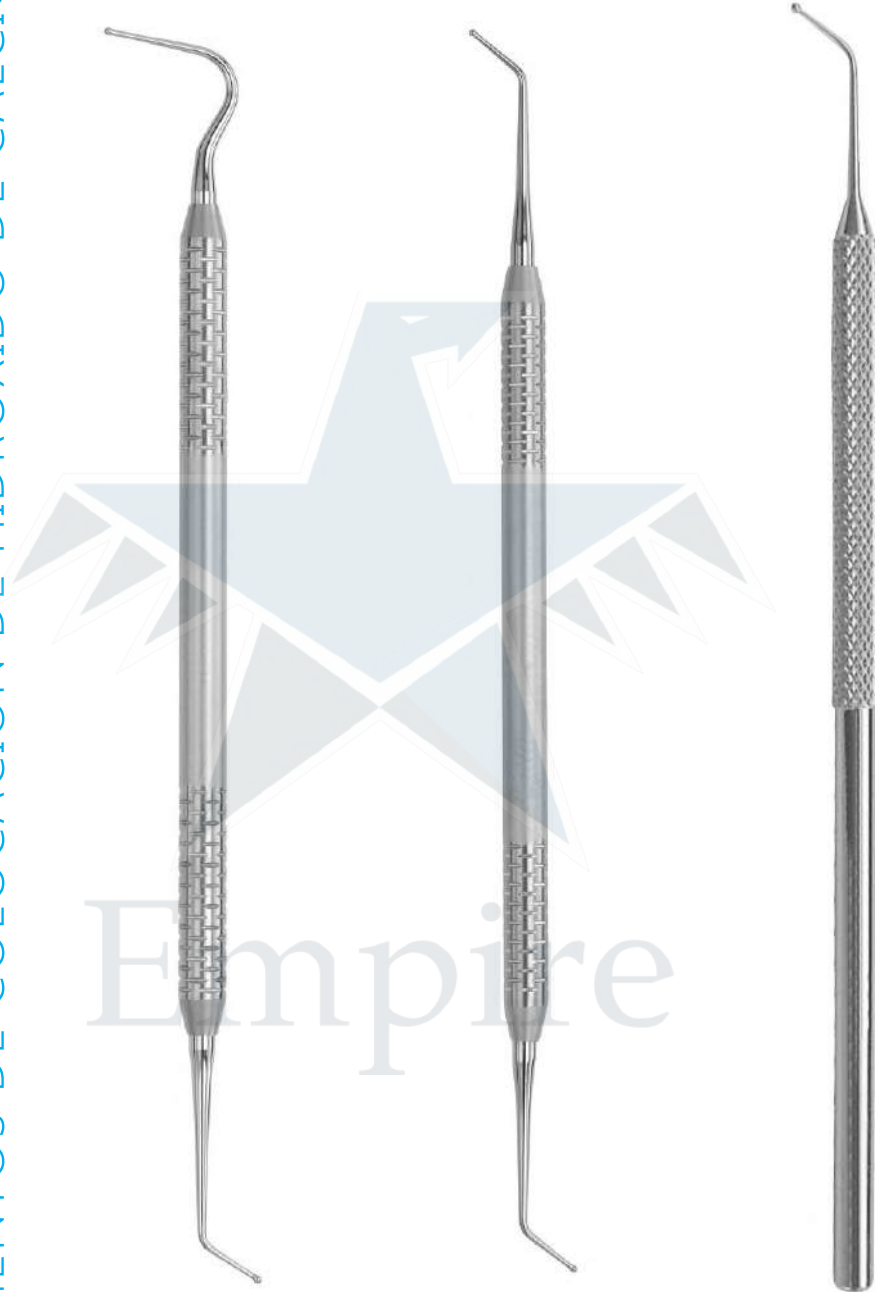

placement instrument  
instrumento de colocación  
instrumento de colocação  
E-335-32

placement instrument  
instrumento de colocación  
instrumento de colocação  
E-335-33

placement instrument  
instrumento de colocación  
instrumento de colocação  
E-335-34



straight concave tip  
 punta cóncava recta  
 ponta côncava reta

- E-847-27 | Ø 2.6-3.2mm [ 160mm
- E-847-32 | Ø 2.2-2.6mm [ 160mm
- E-847-37 | Ø 3.2-3.8mm [ 160mm
- E-847-42 | Ø 3.8-4.2mm [ 160mm



angled concave tip  
 punta cóncava en ángulo  
 ponta côncava angular

- E-847-27 | Ø 2.6-3.2mm [ 160mm
- E847-42 | Ø 2.2-2.6mm [ 160mm
- E-847-32 | Ø 3.2-3.8mm [ 160mm
- E-847-37 | Ø 3.8-4.2mm [ 160mm



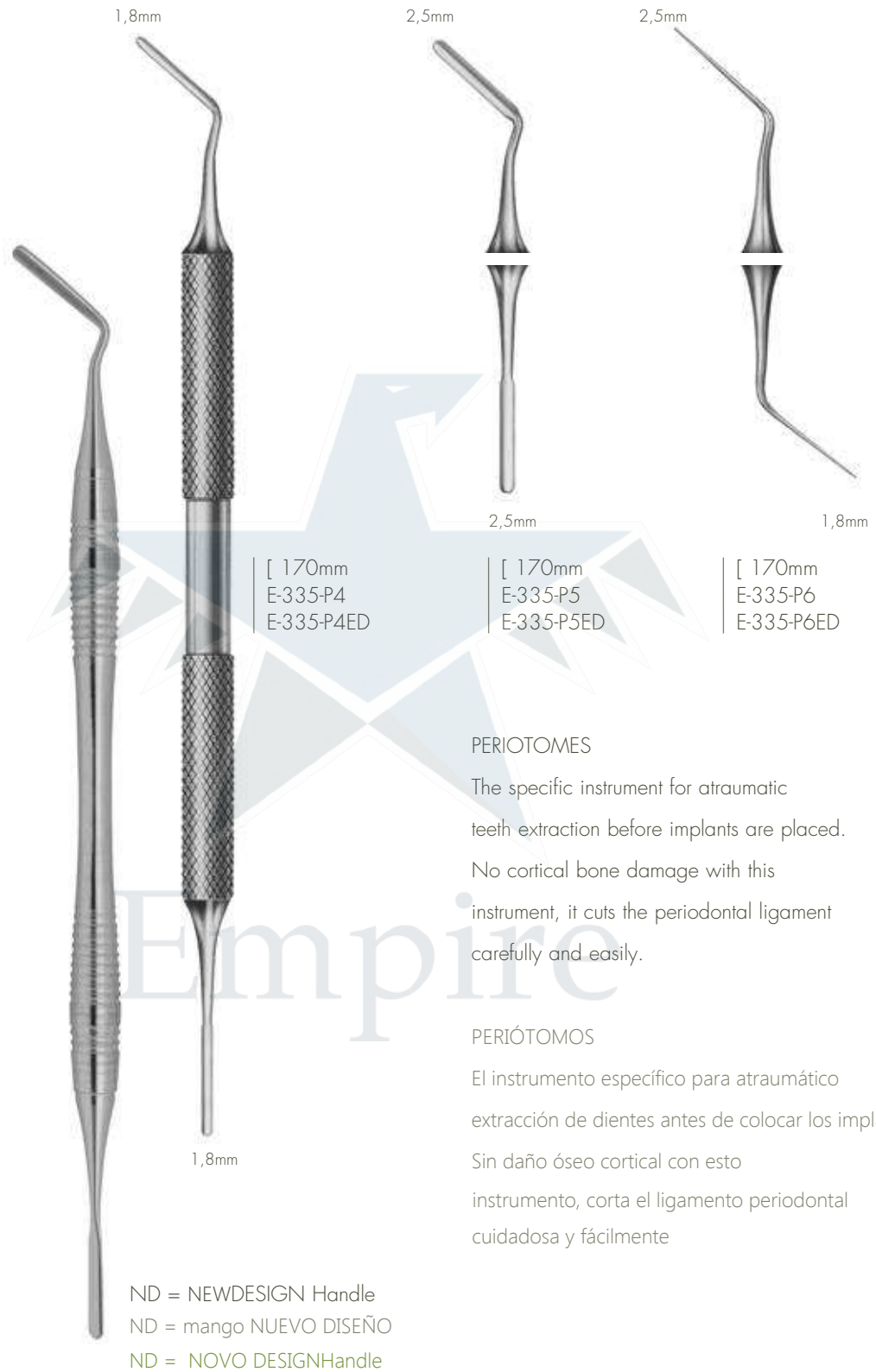



NEW  
NUEVO

The NEWDESIGN

Luxators are used for severing the delicate fibres connecting the tooth root with the jaw bone (ligaments) and extending the tooth socket (alveolus) thus releasing the tooth from the bone and allowing it to be removed easily. This allows the tooth to be extracted gently, which is ideal preparation for implantation.

Mit den NUEVO DISEÑO Luxatoren können die feinen Fasern, die die Zahnwurzel mit dem Kieferknochen verbinden (Ligamente) durchtrennt und das Zahnfach (Alveole) aufgeweitet werden, so dass der Zahn die Verbindung zum Knochen verliert und leicht entfernt werden kann. Somit erhalten Sie eine schonende Extraktion, ideal für die Vorbereitung einer Implantation.

LUXATORS  
LUXADORES

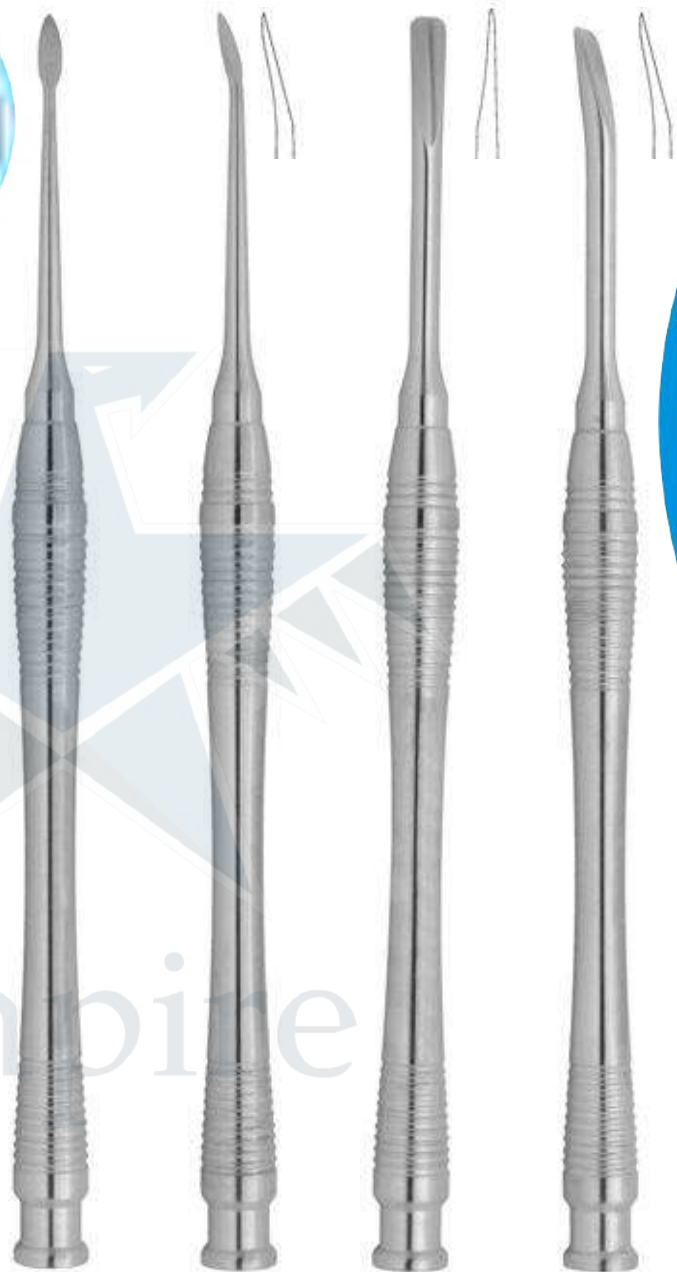

3 mm	E-190-L1ST-ED	E-190-L1C-ED	E-190-3ST-ED	E-190-3C/ED
4 mm	E-190-L2ST/ED	E-190-L2C/ED	E-190-4ST-ED	E-190-4C/ED
4,5 mm			E-190-45ST/ED	E-190-45C/ED

IMPLANTOLOGÍA LUXADORES

244

LUXATORS IMPLANTOLOGY



Forceps  
with tying plate  
Fórceps  
con placa de atado  
Fórceps  
com placa de amarrar  
[ 150mm  
E-184-20  
[ 180mm  
E-184-21

1x2 Z  
[ 150mm  
E-184-24  
[ 180mm  
E-184-25



CASTROVIEJO  
straight  
Derecho  
reto  
[ 120mm  
E-174-59 TC



curved  
curvo  
curvado  
[ 120mm  
E-174-60 TC



CASTROVIEJO  
straight  
Derecho  
reto  
[ 140mm  
E-174-55 TC



curved  
curvo  
curvado  
[ 140mm  
E-174-57 TC



BARAQUER  
straight  
Derecho  
reto  
[ 160mm  
E-174-66 TC



# TITANIUM TITANIO



Needle holder  
straight

Nadelhalter  
Derecho

reto

[ 150mm  
E-174-80 

[ 180mm  
E-174-81 

curved  
curvo  
curvado

[ 150mm  
E-174-82 

[ 180mm  
E-174-83 



Scissors  
straight

Schere  
Derecho

reto

[ 150mm  
E-251-31 

[ 180mm  
E-251-32 

curved  
curvo  
curvado

[ 150mm  
E-251-33 

[ 180mm  
E-251-34 



Forceps  
with tying plate

Pinzette  
mit Fadenplatte

Fórceps  
com placa de amarrar

[ 150mm  
E-184-20 



1x2 Z

[ 150mm  
E-184-24 



# IMPLANT MAINTENANCE

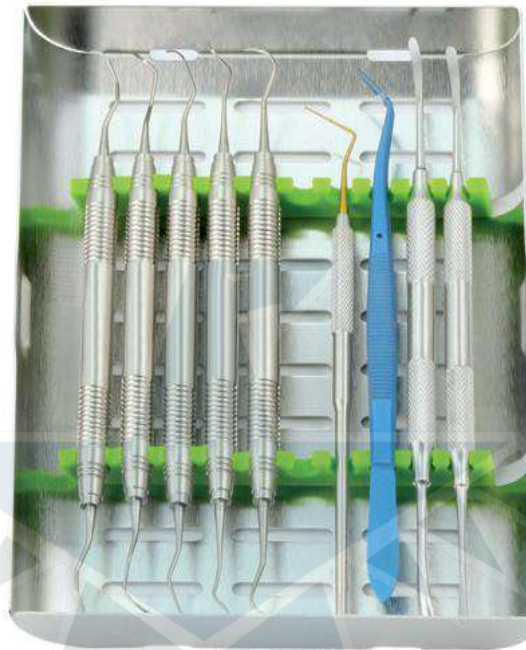

## IMPLANT MAINTENANCE

E-401-L1/2T/ED Langer Titanium - Curette Fig.1-2

E-401-L3/4T/ED Langer Titanium - Curette Fig.3-4

E-401-L5/6T/ED Langer Titanium - Curette Fig.5-6

E-401-204SDT/ED Titanium-Scaler 204SD

E-401-H6/H7T/ED Titanium Scaler H6-H7

E-405-WHO/T PA-Probe WHO, TiN coated

E-180-09T Titanium Meriam Tooth Tweezers

E-335-GF14 Goldman-Fox Raspatories GF 14

E-335-24GSP Glickman Raspatories 24GSP

E-500-01 Wash Tray with Silicon Inserts  
150 x 187 x 25mm

## MANTENIMIENTO DE IMPLANTES

Langer Titanium - Cureta Fig.1-2

Langer Titanium - Cureta Fig.3-4

Langer Titanium - Cureta Fig.5-6

Escalador de titanio 204SD

Escalador de titanio H6-H7

Sonda-PA TiN revestida con TiN

Pinzas para dientes Meriam Titanium

Raspadores Goldman-Fox GF 14

Glickman Raspadores 24GSP

Lavado de bandeja con inserciones de silicona  
150 x 187 x 25mm

- ORTHODONTICS
- ORTODONCIA
- ORTHODONTIA



EMPIRE SURGICAL LTD (THE FUTURE OF HEALTHCARE)



Empire



Flat Nose Pliers  
both sides smooth  
Alicates de punta plana  
ambos lados lisos  
Alicate de nariz plano  
ambos os lados suaves  
[ 140mm  
E-630-02



Flat Nose Pliers  
both sides serrated  
Alicates de punta plana  
ambos lados dentados  
Alicate de nariz plano  
ambos os lados serrilhados  
[ 140mm  
E-630-03



PEESO  
Wire Bending Pliers  
Alicates para doblar cables  
Alicate de dobra do fio  
[ 135mm  
E-630-34



ALL PLIERS AND CUTTERS ARE  
ALSO AVAILABLE IN  
SCREW MODE



Flat Nose Pliers  
both sides serrated  
with TC inserts  
Alicates de punta plana  
ambos lados dentados  
con inserciones TC  
Alicate de nariz plano  
ambos os lados serrilhados  
com inserções de TC  
[ 140mm  
E-630-03 TC

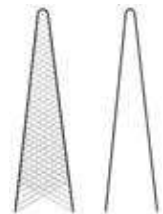

GOSLEE  
Flat Nose Pliers  
Alicates de punta plana  
Alicate de nariz plano  
[ 140mm  
E-630-33



Bracket Removing Pliers  
 Alicates para quitar  
 el soporte  
 ambos os lados suaves  
 E-630-03 /TC



Crown and Band  
 Contouring Pliers  
 Corona y banda  
 Alicates de contorno  
 ambos os lados suaves  
 E-630-06/TC

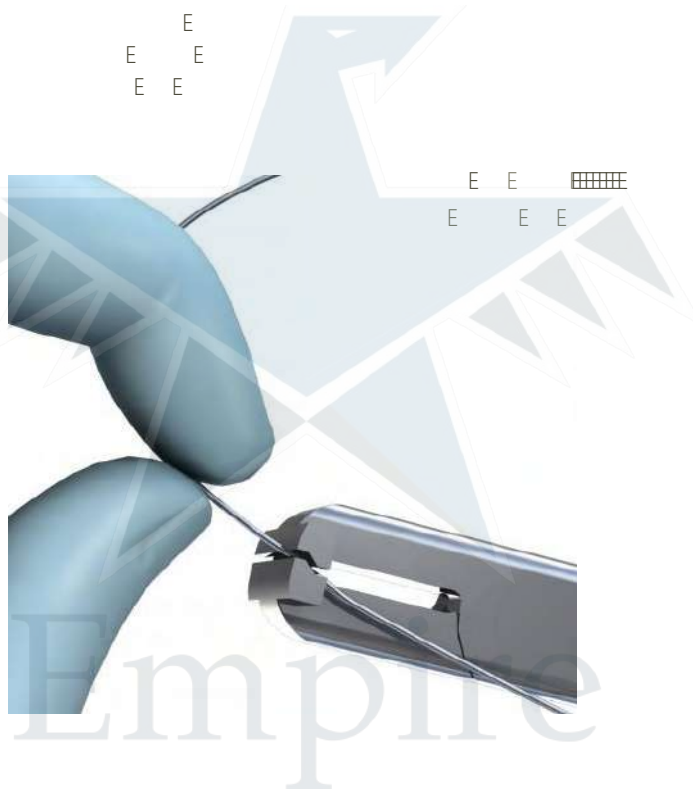

Omega Loop  
 Forming Plier  
 Omega Loop  
 Alicates de formación  
 ambos os lados suaves  
 E-630-08/TC



Step Pliers  
 Alicates de paso  
 ambos os lados suaves  
 E-630-11/TC



Arch Bending Pliers  
 Alicates para doblar arco  
 Alicates De Curvatura Do Arco  
 E-630-14/TC



Bird Beak Plier  
 Alicates Bird Beak  
 Alicate bico do pássaro  
 E-630-17/TC

E E



ALL PLIERS AND CUTTERS ARE  
 ALSO AVAILABLE IN  
 SCREW MODE



Angulated Bracket  
 Removing Pliers  
 Soporte angulado  
 Extracción de alicates  
 Suporte angulado  
 Removendo Alicates  
 E-630-19/TC



Band Crimping Pliers  
 Alicates de engarzado de  
 banda  
 Alicate de friso da faixa  
 E-630-20/TC





Crown and Band Crimping Pliers  
Alicates prensadores de corona y banda  
Coroa e alicate de crimpagem  
E-630-21/TC



Bird Beak Pliers with cutter  
Alicates Bird Beak con cortador  
Alicate de bico de pássaro com cortador  
E-630-22/TC



Distal End Cutter Non Hold  
Cortador de extremo distal no sostenido  
Cortador de extremidade distal não retido  
E-630-23/TC



Distal End Cutter with safety hold Long Handle  
Cortador de extremo distal con agarre de seguridad Mango largo  
Cortador de extremidade distal com pega de segurança Punho longo  
E-630-24/TC



Hard Wire Cutter  
Cortador de alambre duro  
Cortador de fio duro  
E-630-25/TC





Empire

Pin and Ligature Cutter  
Cortador de clavijas y ligaduras  
Pin e cortador de ligaduras

Straight  
Gerade  
reto

E-630-26/TC



Pin and Ligature Cutter  
Cortador de clavijas y ligaduras  
Pin e cortador de ligaduras

Curved  
Gebogen  
curvado

E-630-27/TC



Pin and Ligature Cutter  
Cortador de clavijas y ligaduras  
Pin e cortador de ligaduras

Mini Head  
Gerade  
Mini cabeça

E-630-28/TC



Weingart Utility Plier  
Alicates Weingart Utility  
Alicate Weingart Utility

E-630-29/TC



Weingart Utility Plier with Inserted Tip  
Weingart Utility Plier con punta insertada  
Alicate Weingart Utility com Ponta Inserida

E-630-30/TC





Light wire plier with cutter and grooves  
 Alicates de alambre ligero con cortador y ranuras  
 Alicate de arame leve com cortador e ranhuras  
 E-630-31/TC



Light Wire Plier with cutter  
 Alicates de alambre ligero con cortador  
 Alicate de arame leve com cortador  
 E-630-32/TC



Jaraback Plier with Cutter  
 Alicates Jarabak con Cutter  
 Alicate Jarabak com Cortador  
 E-630-33/TC



Jaraback Plier long tip and serrated round tip  
 Punta larga Jarabak y punta redonda serrada  
 Jarabak Plier Ponta longa e ponta redonda serrilhada  
 E-630-35/TC



Jaraback Plier hollow base  
 Base hueca Jarabak Plier  
 Base oca Jarabak Plier  
 E-630-34/TC



ALL PLIERS AND CUTTERS ARE  
 ALSO AVAILABLE IN  
 SCREW MODE



Empire



Anterior Bracket Removing Plier  
Alicates para quitar el soporte anterior  
Suporte Anterior Removendo Alicates  
E-630-36/TC



Optical Pliers  
Alicates ópticos  
Alicates Óticos  
E-630-37/TC



Pin Placing Pliers  
Pin colocando alicates  
Pin Alicates de Colocação  
E-630-38/TC



How Plier with small tip  
Cómo alicates con punta pequeña  
Como alicates com ponta pequena  
E-630-39/TC





cutter N.92TC  
cortador N.92TC  
cortador N.92  
140mm  
E-632-13



hard wire cutter with TC inserts  
cortador de alambre duro con inserciones TC  
cortador de fio duro  
160mm  
E-632-07

cutting hard wire 2.8mm and soft wire 2.2mm





cutter N.94 TC  
cortador N.94 TC  
cortador N.94 TC  
130mm  
E-632-18

cutter N.87 TC  
cortador N.87 TC  
cortador N.87 TC  
130mm  
E-632-17

cutter N.18 TC  
cortador N.18 TC  
cortador N.18 TC  
155mm  
E-632-21





BÖHM  
Teleopic Crown Forceps  
Pinzas de corona telescópicas  
Pinça de coroa telescópica  
[ 120mm  
E-255-01

[ 150mm  
E-255-02



diamond coated tips  
puntas recubiertas de diamante  
pontas revestidas de diamantes

[ 120mm  
E-255-01D/TC



BÖHM  
Teleopic Crown Forceps  
with interchangeable  
diamond tips  
Pinzas de corona telescópicas  
con intercambiables  
con intercambiables  
Pinça de coroa telescópica  
com intercambiáveis  
pontas de diamante

[ 120mm  
E-255-31

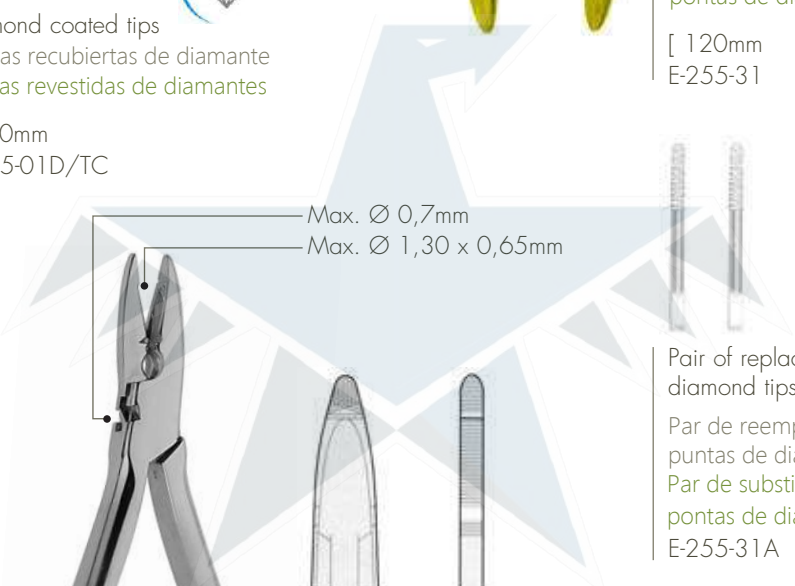

Max. Ø 0,7mm  
Max. Ø 1,30 x 0,65mm



Pair of replacement  
diamond tips  
Par de reemplazo  
puntas de diamante  
Par de substituição  
pontas de diamante  
E-255-31A

WALDSACHS  
Universal Pliers  
for soft and hard wire  
Alicates universales  
para alambre suave y duro  
Alicate universal  
para arame macio e duro  
☒ Max. Ø 0,7mm / .028"  
1,30 x 0,65mm / .052 x .026"  
[ 150mm  
E-631-03/TC



Max. Ø 0,7mm  
Max. Ø 0,9mm

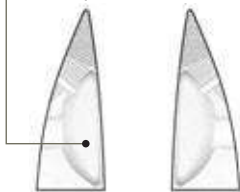

Universal Pliers  
for soft and hard wire  
Alicates universales  
para alambre suave y duro  
Alicate universal  
para arame macio e duro  
[ 160mm  
E-631-05/TC



Max. Ø 0,7mm  
Max. Ø 0,9mm

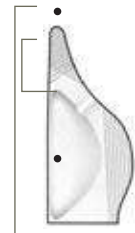

Universal Pliers  
for soft and hard wire  
Alicates universales  
para alambre suave y  
duro  
Alicate universal  
para arame macio e duro  
[ 150mm  
E-631-04/TC



- INSTRUMENT MANAGEMENT
- GESTIÓN DE INSTRUMENTOS
- GESTÃO DE INSTRUMENTOS



EMPIRE SURGICAL LTD (THE FUTURE OF HEALTHCARE)

"Cassate trays are the secure and efficient way to organize your hand instruments."

"Las bandejas de cassette son la forma segura y eficiente de organizar sus instrumentos de mano".

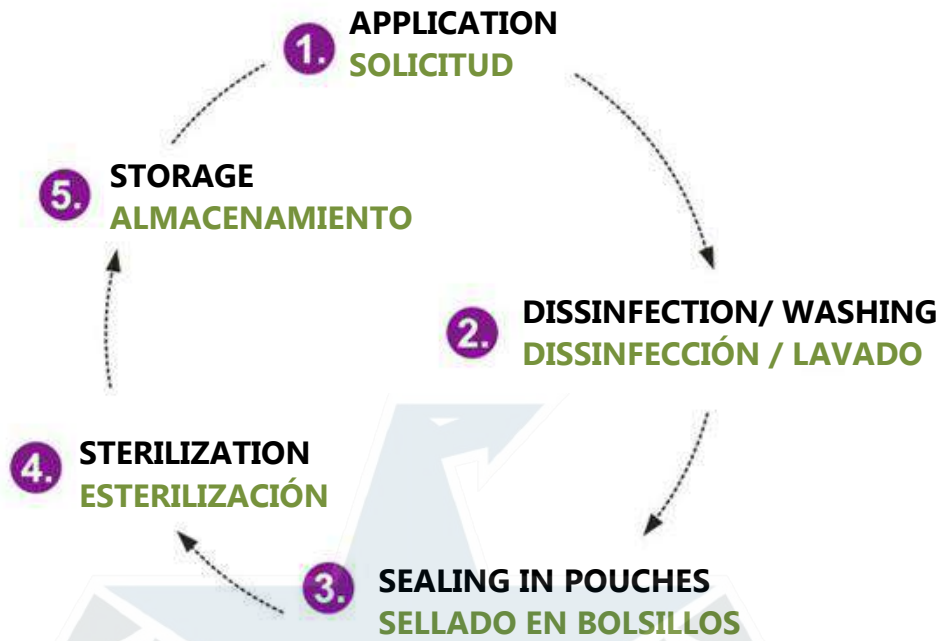

180 x 85 x 19mm  
E-508-02  
Stainless Steel for 5 instruments  
pero ligero Inserciones  
de acero inoxidable y silicona



185 x 100 x 15mm  
E-508-00  
Stainless Steel for 7 instruments  
pero ligero Inserciones  
de acero inoxidable y silicona

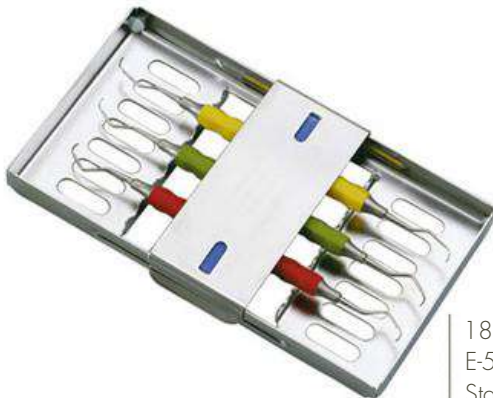

185 x 100 x 15mm  
E-518-06  
Stainless Steel for 7 instruments  
pero ligero Inserciones  
de acero inoxidable y silicona



180 x 140 x 25mm  
E-508-04  
Stainless Steel for 10 instruments  
pero ligero Inserciones  
de acero inoxidable y silicona



NEW-CLIP Wash Tray  
allows visible and ordered  
storage of 5 Instruments

Bandeja de lavado NUEVO-CLIP  
permite visible y ordenado  
almacenamiento de  
5 instrumentos

110 x 184 x 25 mm  
E-500-TK



NEW-CLIP Wash Tray  
allows visible and ordered  
storage of 10 Instruments

Bandeja de lavado NUEVO-CLIP  
permite visible y ordenado  
almacenamiento de  
10 instrumentos

150 x 184 x 25 mm  
E-500-T



NEW CASSETTE Wash Tray  
allows visible and ordered  
storage of 10 Instruments

Bandeja de lavado NUEVO CASSETTE  
permite visible y ordenado  
almacenamiento de  
10 instrumentos

150 x 187 x 25mm  
E-500-01

NEW CASSETTE Wash Tray  
allows visible and ordered storage  
of 10 Instruments and accessories

Bandeja de lavado NUEVO CASSETTE  
permite visible y ordenado  
almacenamiento de  
10 instrumentos y accesorios

230 x 187 x 25 mm  
E-500-02

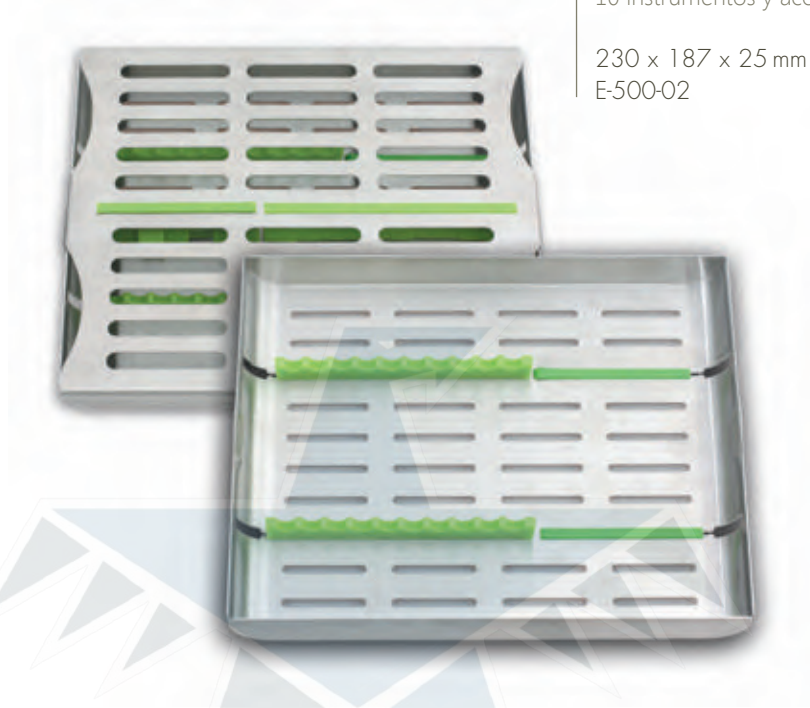

BANDEJAS DE INSTRUMENTOS

262

INSTRUMENT TRAYS

NEW CASSETTE Wash Tray  
allows visible and ordered  
storage of 20 Instruments

Bandeja de lavado NUEVO CASSETTE  
permite visible y ordenado  
almacenamiento de  
10 instrumentos

288 x 187 x 25 mm  
E-500-03





ULTRALIGHT CASSETTES

CASETES ULTRALIGEROS



290 x 185 x 35 mm  
E-510-00

ULTRALIGHT Locking  
Cassettes For 20 Instruments  
Removable cover  
Very strong but light  
Stainless Steel and Silicone inserts

Bloqueo ULTRALIGERO  
Cassettes para 20 instrumentos  
Cubierta extraíble Muy fuerte  
pero ligero Inserciones  
de acero inoxidable y silicona

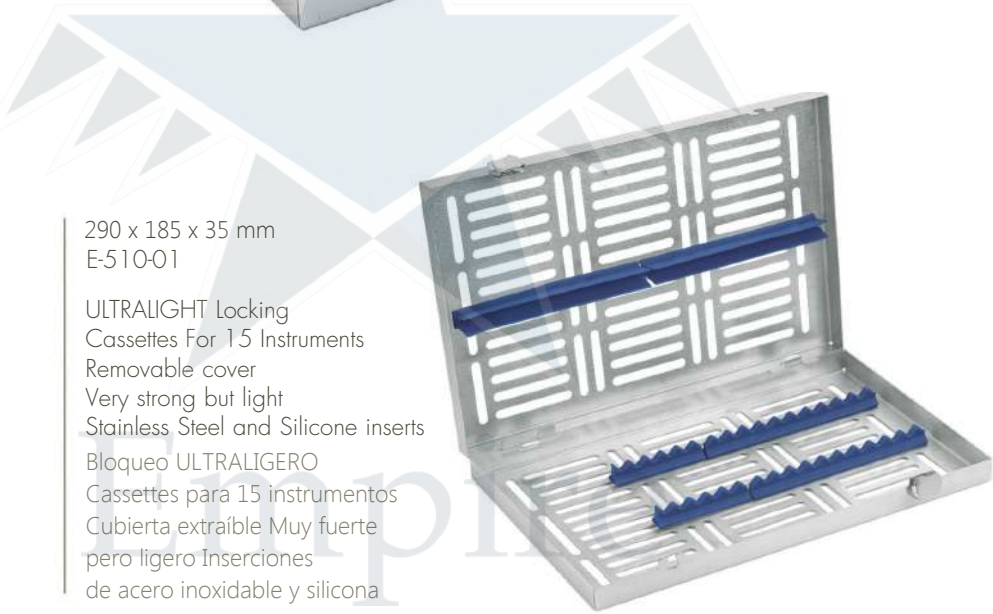

290 x 185 x 35 mm  
E-510-01

ULTRALIGHT Locking  
Cassettes For 15 Instruments  
Removable cover  
Very strong but light  
Stainless Steel and Silicone inserts

Bloqueo ULTRALIGERO  
Cassettes para 15 instrumentos  
Cubierta extraíble Muy fuerte  
pero ligero Inserciones  
de acero inoxidable y silicona



290x185x35 mm  
E-510-02

ULTRALIGHT Locking  
Cassettes For 10 Instruments  
Removable cover  
Very strong but light  
Stainless Steel and Silicone inserts

Bloqueo ULTRALIGERO  
Cassettes para 10 instrumentos  
Cubierta extraíble Muy fuerte  
pero ligero Inserciones  
de acero inoxidable y silicona

185 x 145 x 35mm  
E-510-03

ULTRALIGHT Locking  
Cassettes For 10 Instruments  
Removable cover  
Very strong but light  
Stainless Steel and Silicone inserts  
Bloqueo ULTRALIGERO  
Cassettes para 10 instrumentos  
Cubierta extraíble Muy fuerte  
pero ligero Inserciones  
de acero inoxidable y silicona



185 x 145 x 35mm  
E-510-04

ULTRALIGHT Locking  
Cassettes For 5 Instruments  
Removable cover  
Very strong but light  
Stainless Steel and Silicone inserts  
Bloqueo ULTRALIGERO  
Cassettes para 5 instrumentos  
Cubierta extraíble Muy fuerte  
pero ligero Inserciones  
de acero inoxidable y silicona

185x 73 x 35mm  
E-510-05

ULTRALIGHT Locking  
Cassettes For 5 Instruments  
Removable cover  
Very strong but light  
Stainless Steel and Silicone inserts  
Bloqueo ULTRALIGERO  
Cassettes para 5 instrumentos  
Cubierta extraíble Muy fuerte  
pero ligero Inserciones  
de acero inoxidable y silicona

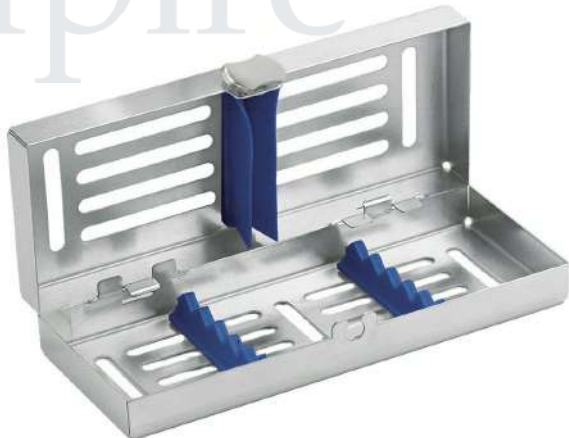

Empire





290 x 185 x 35 mm  
E-511-00

ULTRALIGHT Locking  
Cassettes For 20 Instruments  
Removable cover  
Very strong but light  
Stainless Steel and Silicone inserts  
Bloqueo ULTRALIGERO  
Cassettes para 20 instrumentos  
Cubierta extraíble Muy fuerte  
pero ligero Inserciones  
de acero inoxidable y silicona



290 x 185 x 35 mm  
E-511-01

ULTRALIGHT Locking  
Cassettes For 15 Instruments  
Removable cover  
Very strong but light  
Stainless Steel and Silicone inserts  
Bloqueo ULTRALIGERO  
Cassettes para 15 instrumentos  
Cubierta extraíble Muy fuerte  
pero ligero Inserciones  
de acero inoxidable y silicona



290 x 185 x 35 mm  
E-511-02

ULTRALIGHT Locking  
Cassettes For 10 Instruments  
Removable cover  
Very strong but light  
Stainless Steel and Silicone inserts  
Bloqueo ULTRALIGERO  
Cassettes para 10 instrumentos  
Cubierta extraíble Muy fuerte  
pero ligero Inserciones  
de acero inoxidable y silicona

# ULTRALIGHT CASSETTES

## CASETES ULTRALIGEROS

185 x 145 x 35mm  
E-511-03

ULTRALIGHT Locking  
Cassettes For 10 Instruments  
Removable cover  
Very strong but light  
Stainless Steel and Silicone inserts  
Bloqueo ULTRALIGERO  
Cassettes para 10 instrumentos  
Cubierta extraíble Muy fuerte  
pero ligero Inserciones  
de acero inoxidable y silicona



185 x 145 x 35mm  
E-511-04

ULTRALIGHT Locking  
Cassettes For 5 Instruments  
Removable cover  
Very strong but light  
Stainless Steel and Silicone inserts  
Bloqueo ULTRALIGERO  
Cassettes para 5 instrumentos  
Cubierta extraíble Muy fuerte  
pero ligero Inserciones  
de acero inoxidable y silicona

185 x 73 x 35mm  
E-511-05

ULTRALIGHT Locking  
Cassettes For 5 Instruments  
Removable cover  
Very strong but light  
Stainless Steel and Silicone inserts  
Bloqueo ULTRALIGERO  
Cassettes para 5 instrumentos  
Cubierta extraíble Muy fuerte  
pero ligero Inserciones  
de acero inoxidable y silicona

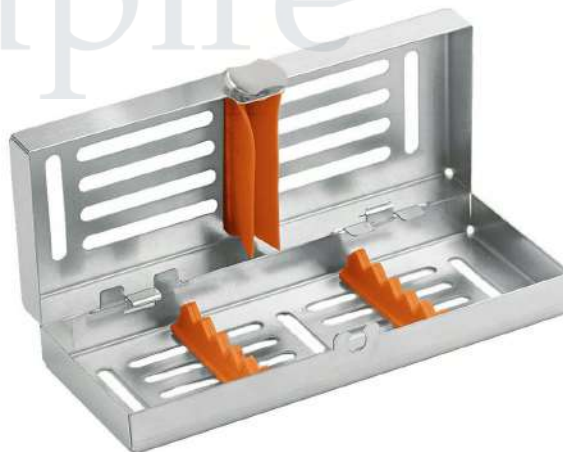





290 x 185 x 35 mm  
E-512-00  
ULTRALIGHT Locking  
Cassettes For 20 Instruments  
Removable cover  
Very strong but light  
Stainless Steel and Silicone inserts  
Bloqueo ULTRALIGERO  
Cassettes para 20 instrumentos  
Cubierta extraíble Muy fuerte  
pero ligero Inserciones  
de acero inoxidable y silicona



290 x 185 x 35 mm  
E-512-01  
ULTRALIGHT Locking  
Cassettes For 15 Instruments  
Removable cover  
Very strong but light  
Stainless Steel and Silicone inserts  
Bloqueo ULTRALIGERO  
Cassettes para 15 instrumentos  
Cubierta extraíble Muy fuerte  
pero ligero Inserciones  
de acero inoxidable y silicona



290 x 185 x 35 mm  
E-512-02  
ULTRALIGHT Locking  
Cassettes For 10 Instruments  
Removable cover  
Very strong but light  
Stainless Steel and Silicone inserts  
Bloqueo ULTRALIGERO  
Cassettes para 10 instrumentos  
Cubierta extraíble Muy fuerte  
pero ligero Inserciones  
de acero inoxidable y silicona

185 x 145 x 35mm  
E-512-03

ULTRALIGHT Locking  
Cassettes For 10 Instruments  
Removable cover  
Very strong but light  
Stainless Steel and Silicone inserts  
Bloqueo ULTRALIGERO  
Cassettes para 10 instrumentos  
Cubierta extraíble Muy fuerte  
pero ligero Inserciones  
de acero inoxidable y silicona

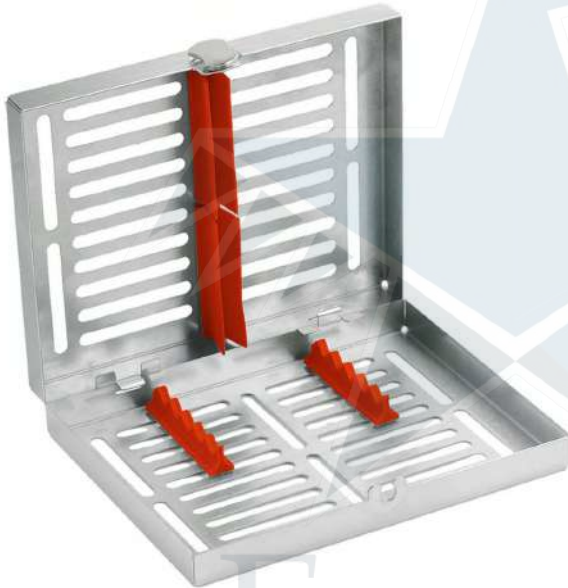

185 x 145 x 35mm  
E-512-04

ULTRALIGHT Locking  
Cassettes For 5 Instruments  
Removable cover  
Very strong but light  
Stainless Steel and Silicone inserts  
Bloqueo ULTRALIGERO  
Cassettes para 5 instrumentos  
Cubierta extraíble Muy fuerte  
pero ligero Inserciones  
de acero inoxidable y silicona

185x 73 x 35mm  
E-512-05

Cassettes For 5 Instruments  
Removable cover  
Very strong but light  
Stainless Steel and Silicone inserts  
Bloqueo ULTRALIGERO  
Cassettes para 5 instrumentos  
Cubierta extraíble Muy fuerte  
pero ligero Inserciones  
de acero inoxidable y silicona

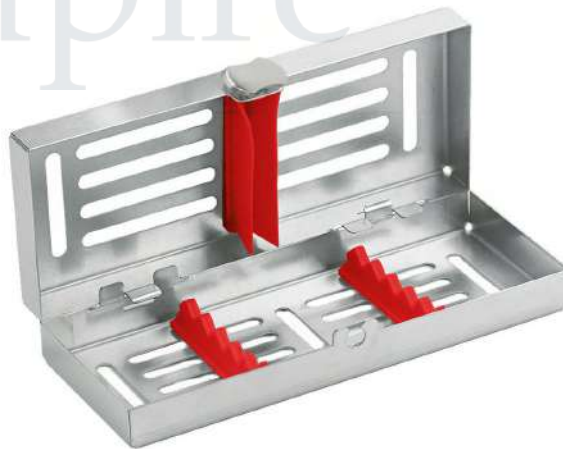

Empire



290 x 185 x 35 mm  
E-513-00

ULTRALIGHT Locking  
Cassettes For 20 Instruments  
Removable cover  
Very strong but light  
Stainless Steel and Silicone inserts  
Bloqueo ULTRALIGERO  
Cassettes para 20 instrumentos  
Cubierta extraible Muy fuerte  
pero ligero Inserciones  
de acero inoxidable y silicona



290 x 185 x 35 mm  
E-513-01

ULTRALIGHT Locking  
Cassettes For 15 Instruments  
Removable cover  
Very strong but light  
Stainless Steel and Silicone insert  
Bloqueo ULTRALIGERO  
Cassettes para 15 instrumentos  
Cubierta extraible Muy fuerte  
pero ligero Inserciones  
de acero inoxidable y silicona



290 x 185 x 35 mm  
E-513-02

ULTRALIGHT Locking  
Cassettes For 10 Instruments  
Removable cover  
Very strong but light  
Stainless Steel and Silicone inserts  
Bloqueo ULTRALIGERO  
Cassettes para 10 instrumentos  
Cubierta extraible Muy fuerte  
pero ligero Inserciones  
de acero inoxidable y silicona



185 x 145 x 35mm  
E-513-03

ULTRALIGHT Locking  
Cassettes For 10 Instruments  
Removable cover  
Very strong but light  
Stainless Steel and Silicone inserts  
Bloqueo ULTRALIGERO  
Cassettes para 10 instrumentos  
Cubierta extraíble Muy fuerte  
pero ligero Inserciones  
de acero inoxidable y silicona

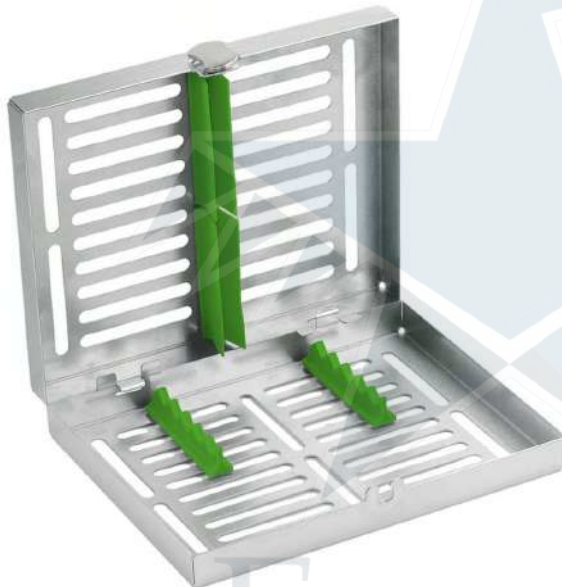

185 x 145 x 35mm  
E-513-04

ULTRALIGHT Locking  
Cassettes For 5 Instruments  
Removable cover  
Very strong but light  
Stainless Steel and Silicone inserts  
Bloqueo ULTRALIGERO  
Cassettes para 5 instrumentos  
Cubierta extraíble Muy fuerte  
pero ligero Inserciones  
de acero inoxidable y silicona

185x 73 x 35mm  
E-513-05

ULTRALIGHT Locking  
Cassettes For 5 Instruments  
Removable cover  
Very strong but light  
Stainless Steel and Silicone inserts  
Bloqueo ULTRALIGERO  
Cassettes para 5 instrumentos  
Cubierta extraíble Muy fuerte  
pero ligero Inserciones  
de acero inoxidable y silicona

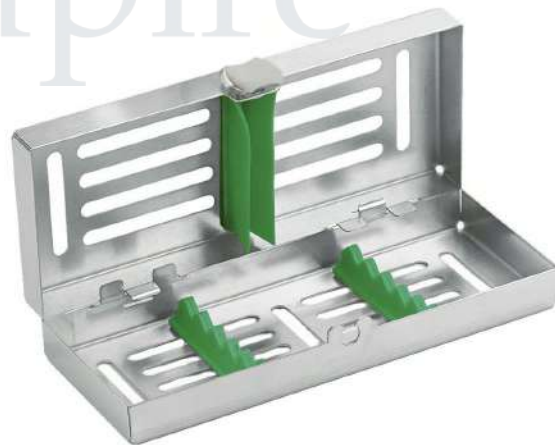

● All Trays are customizable, Depends on your requirement





Empire



Insert Frame, 8 positions  
Insertar marco, 8 posiciones  
Inserir quadro, 8 posições  
185 x 140 x 15mm  
E-520-00



Insert Frame, 23 positions  
Insertar marco, 23 posiciones  
reInserir quadro, 23 posições  
285 x 185 x 15mm  
E-521-00



E-520-01



E-520-02

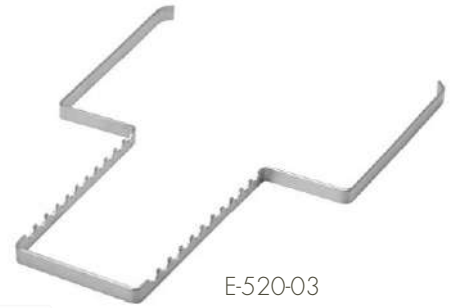

E-520-03



E-521-01



E-521-02



E-521-03

Empire



Tray only  
without Lid

Perforated Tray  
Bandeja perforada  
Bandeja perfurada  
285 x 185 x 15mm  
E-515-26



Lid only  
Solo tapa  
Apenas tampa  
285 x 185 x 15mm  
E-515-27



Tray, aluminium  
 Bandeja de Aluminio  
 Bandeja de Aluminio  
 290 x 190 x 30mm  
 E-515-12



Kidney Bowl N-1  
 Riñón, cuenco, N-1  
 Bacia do Rim N-1  
 220 x 120mm  
 E-515-02

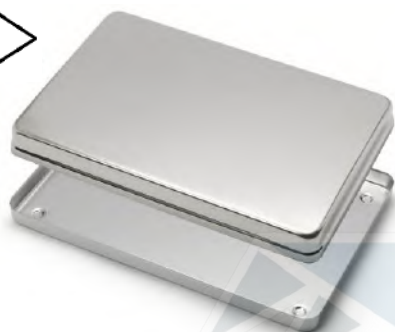
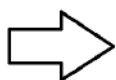

Lid only  
 Solo tapa  
 Apenas tampa  
 290 x 190 x 30mm  
 E-515-13

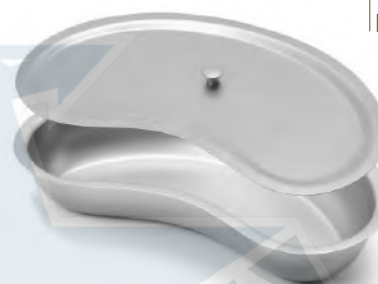

Kidney Bowl N-1 Lid  
 Bacia do Rim N-1 Lid  
 Tapa de riñón Bowl N-1  
 220 x 120mm  
 E-515-03

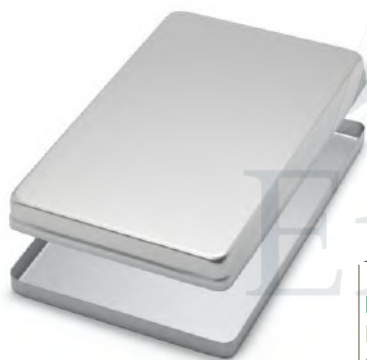
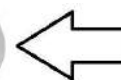

Tray, aluminium  
 Bandeja de aluminio  
 Bandeja de Aluminio  
 285 x 185 x 15mm  
 E-515-14



Kidney Bowl N-2  
 Riñón, cuenco, N-2  
 Bacia do Rim N-2  
 310 x 190mm  
 E-515-07

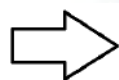

Lid only  
 Solo tapa  
 Apenas tampa  
 285 x 185 x 15mm  
 E-515-15



Kidney Bowl N-2 Lid  
 Tapa de riñón Bowl N-2  
 Tampa do Rim Tigela N-2  
 310 x 190mm  
 E-515-08

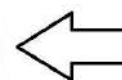



Empire



Tray, Blue  
Bandeja, azul  
Bandeja Azul  
285 x 185 x 15mm  
E-515-18



Tray, Green  
Bandeja, verde  
Bandeja Verde  
285 x 185 x 15mm  
E-515-20



Tray, Golden  
Bandeja, dorada  
Bandeja Dourada  
285 x 185 x 15mm  
E-515-22



Tray, Red  
Bandeja, rojo  
Bandeja, Vermelho  
285 x 185 x 15mm  
E-515-24



Perforated Tray, Blue  
Bandeja perforada, azul  
Bandeja perfurada, azul  
285 x 185 x 15mm  
E-515-19

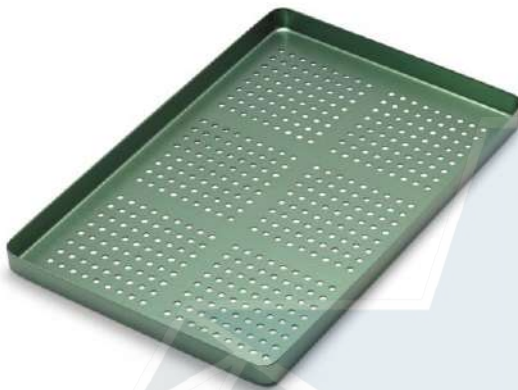

Perforated Tray, Green  
Bandeja perforada, verde  
Bandeja perfurada, verde  
285 x 185 x 15mm  
E-515-21

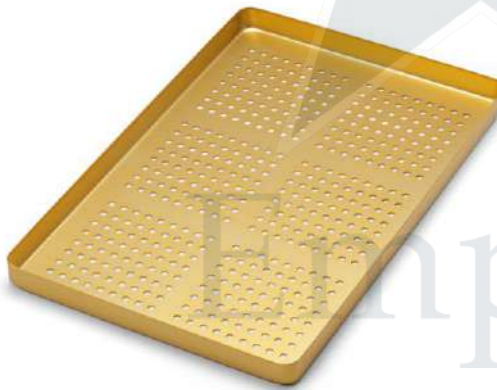

Perforated Tray, Golden  
Bandeja perforada, dorada  
Bandeja perfurada, dourada  
285 x 185 x 15mm  
E-515-23



Perforated Tray, Red  
Bandeja perforada, rojo  
Bandeja perfurada, vermelha  
285 x 185 x 15mm  
E-515-25



- LABORATORY INSTRUMENTS
- INSTRUMENTOS DE LABORATORIO
- INSTRUMENTOS DE LABORATÓRIO



EMPIRE SURGICAL LTD (THE FUTURE OF HEALTHCARE)



N-1  
 Mixing Cup  
 Copa de mezcla  
 Copo de mistura  
 60mm  
 E-517-01



N-0  
 Mixing Cup  
 Copa de mezcla  
 Copo de mistura  
 40mm  
 E-517-00



N-2  
 Mixing Cup  
 Copa de mezcla  
 Copo de mistura  
 80mm  
 E-517-02

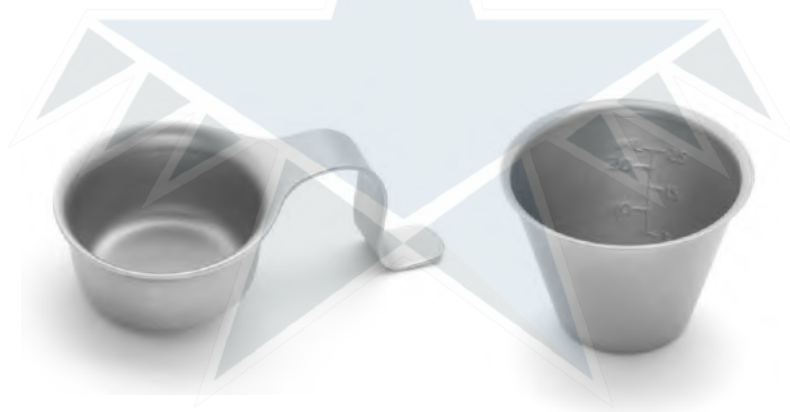

Mixing Cup with handle  
 Taza de mezcla con mango  
 Copo de mistura com alça  
 25mm  
 E-517-06

Mixing Cup with scale  
 Copa de mezcla con escala  
 Copo de mistura  
 45mm  
 E-517-08





Mixing Bowl  
Tazón de mezcla  
Tigela de mistura  
140mm  
E-517-14



Mixing Bowl  
Tazón de mezcla  
Tigela de mistura  
120mm  
E-517-16



Mixing Bowl  
Tazón de mezcla  
Tigela de mistura  
100mm  
E-517-18



E-1810-05

Light weight anatomic articulator made of aluminium die-casting. It can be used following the geometrical laws of medium values (Bonwill-triangle). Fixing according to centric. Automatic return to the hinge axis with springs. Anti-shock hinge rod in case articulator falls accidentally. Bigger size lock screws for mounting plates.

Articulador anatómico ligero hecho de fundición a presión de aluminio. Se puede usar siguiendo las leyes geométricas de los valores medios (triángulo de Bonwill). Fijación según céntrico Retorno automático al eje de la bisagra con muelles. Varilla de bisagra antichoque en caso de que el articulador caiga accidentalmente. Tornillos de bloqueo de tamaño más grande para placas de montaje.

Antishock system  
Sistema Antishock

- Incisal guide rod and bearing rod for 180° opening are in stainless steel.
- Stainless steel hinge rod.
- La varilla de guía incisal y la varilla de rodamiento para 180° de apertura están en acero inoxidable.
- Varilla de bisagra de acero inoxidable.

Anatomic back shoulders favour a practical and efficient holding of the articulator.

Los hombros anatómicos de la espalda favorecen una sujeción práctica y eficiente del articulador.

Intercondylar distance	120 mm.
Condylar inclination	fixed at 30°
Bennet angle	fixed at 7°
Incisal table inclination	10°
Distance between mounting plates	90-110 mm.
Weight	700 gr.
Opening	180°





Empire

Adjustable back rod by registration screw to work without incisal rod by keeping constant trajectories and inclinations during side and back/forward movements. Pure translation movement (key and instructions included.)

Varilla trasera ajustable por tornillo de registro para trabajar sin incisal varilla al mantener trayectorias e inclinaciones constantes durante el lado y movimientos hacia atrás / adelante. Movimiento puro de traducción (clave e instrucciones incluidas.)



E-1820-05

Pure translation movement allowed  
Movimiento de traducción puro permitido

Easy mechanisms regulation  
Regulación fácil de los mecanismos

Empire



- 2 spacers
- 2 magnetic mounting plates
- 2 long screws for plates
- 2 short screws for plates
- 2 espaciadores
- 2 placas de montaje magnéticas
- 2 tornillos largos para placas
- 2 tornillos cortos para placas



E-1830-05

Light weight anatomic articulator made of aluminium die-casting. It can be used following the geometrical laws of medium values (Bonwill-triangle). Fixing according to centric. Automatic return to the hinge axis with springs. Anti-shock hinge rod in case articulator falls accidentally. Bigger size lock screws for mounting plates.

Articulador anatómico ligero hecho de fundición a presión de aluminio. Se puede usar siguiendo las leyes geométricas de los valores medios (triángulo de Bonwill). Fijación según céntrico Retorno automático al eje de la bisagra con muelles. Varilla de bisagra antichoque en caso de que el articulador caiga accidentalmente. Tornillos de bloqueo de tamaño más grande para placas de montaje.

- Incisal guide rod and bearing rod for 180° opening are in stainless steel.
- Stainless steel hinge rod.
- La varilla de guía incisal y la varilla de rodamiento para 180° de apertura están en acero inoxidable.
- Varilla de bisagra de acero inoxidable.

Anatomic back shoulders favour a practical and efficient holding of the articulator.

Los hombros anatómicos de la espalda favorecen una sujeción práctica y eficiente del articulador.



<i>Intercondylar distance</i>	<i>110 mm.</i>
<i>Condylar inclination</i>	<i>fixed at 30°</i>
<i>Bennet angle</i>	<i>fixed at 7°</i>
<i>Incisal table inclination</i>	<i>10°</i>
<i>Distance between mounting plates</i>	<i>85 mm.</i>
<i>Weight</i>	<i>400 gr.</i>





Empire



E-1840-05

Adjustable back rod by registration screw to work without incisal rod by keeping constant trajectories and inclinations during side and back/forward movements. Pure translation movement (key and instructions included.)

Anti-shock hinge rod in case articulo falls accidentally. Bigger size lock screw for mounting plates. Interchangeable self centring aluminium mounting plates or magnetic plates.

Varilla trasera ajustable por tornillo de registro para trabajar sin incisal varilla al mantener trayectorias e inclinaciones constantes durante el lado y movimientos hacia atrás / adelante. Movimiento puro de traducción (clave e instrucciones incluidas.)

Varilla de bisagra antichoque en caso de que el articulo caiga accidentalmente. Tornillo de bloqueo Biggersize para placas de montaje. Placas de montaje de aluminio autocentrantes intercambiables o placas magnéticas.





E-1850-05

- 2 mounting plates
- 2 screws for plates
- 2 tornillos para placas
- 2 placas de montaje



Accluser  
Accluser







Code						Description
1	o	o	o	o	o	Mounting plate
2	o	o	o	-	-	Occlusal table
2b	-	-	-	o	o	Occlusal table
3	o	o	o	-	-	Incisal guide rod
3b	-	-	-	o	o	Incisal guide rod
4	o	o	-	o	-	Incisal table 10'
4b	-	-	o	-	o	Round flat incisal table
5	o	o	o	o	o	Incisal table and guide rod lock screws
6	o	o	-	-	-	Mounting plate and table lock screws
6b	-	-	o	o	o	Mounting plate and occlusal table screws
6c	-	-	-	o	o	Mounting plate and occlusal table screws with spacer
7	o	o	o	o	o	Adjustable side shift lock screw
8	o	o	o	o	o	Incisal indicator pin
9	o	o	o	o	o	Side shift screw
10	-	o	o	-	-	Bearing rod for 180° opening
10b	-	-	-	o	o	Bearing rod for 180° opening
11	-	o	o	o	o	Rod rubber protection
12	o	o	o	o	o	Side shift spring
13	o	o	o	o	o	Side shift cylinder
14	o	o	o	o	o	M5 screws for incisal table fixing
16	-	-	o	-	-	Contrast inclined plane
16b	-	-	-	-	o	Contrast inclined plane
17	o	o	o	-	-	Hinge rod
17b	-	-	-	o	o	Hinge rod
18	o	o	o	o	o	Hinge rod washer
19	o	o	o	o	o	Hinge rod spring
20	-	-	o	-	-	Back rod support
21	-	-	o	-	-	Back rod
21b	-	-	-	-	o	Back rod
22	-	-	o	-	-	Set screw
22b	-	-	-	-	o	Set screw
23	-	-	o	-	-	Set screw locking
23b	-	-	-	-	o	Set screw locking
24	o	o	o	o	o	Rubber support
29	-	-	-	o	o	Spacer
30	-	-	-	o	o	Fast Caliper
25	-	-	-	-	-	Cast fastening washers (10 pcs package)
26	-	-	-	-	-	Magnet
27	-	-	-	-	-	Magnet holder
28	o	o	o	o	o	Complete magnetic plate



Empire



FAHNENSTOCK  
[ 130mm  
E-270-01



FAHNENSTOCK  
[ 170mm  
E-270-02



BUFFALO  
[ 130mm  
E-270-06



[ 170mm  
E-270-08



GRITMAN  
[ 160mm  
E-270-09



GRITMANN  
[ 160mm  
E-275-01



Spatula  
curved,  
narrow  
Espátula  
curvo,  
estrecho  
Espátula  
curvado,  
limitar  
E-275-03



Spatula  
straight, wide  
Espátula  
derecho, ancho  
Espátula  
direito, largo  
E-275-04

Spatula  
straight, narrow  
Espátula  
derecho, estrecho  
Espátula  
em linha reta, estreito  
E-275-05



ROGHE  
E-275-06



AUTOCLAVABLE  
AUTOCLAVABLE  
DESINTERESSADO



PLASTER SHEAR, MANUALLY OPERATED  
CORTADOR DE YESO, MANUALMENTE OPERADO  
CINCO DE PLASTER, MANUALMENTE  
OPERADO  
[ 220mm  
E-270-12



PLASTER SHEAR, PLASTIC HANDLE  
CORTADOR DE YESO, MANGO DE PLÁSTICO  
CINCO DE PLASTER, MANGUEIRA  
DE PLÁSTICO  
[ 210mm  
E-270-13



Saw, Blade  
Hoja de sierra  
Lâmina de serra  
250mm  
E-561-05

Saw  
Sierra  
Serra  
250mm  
E-561-04



Saw for models  
Sierra para modelos  
Serra para modelos  
180mm  
E-561-07



Saw for models, Blade  
Sierra para modelos, cuchilla  
Serra para modelos, Lâmina  
180mm  
E-561-08



Alcohol Burnner  
Alcohol quemador  
Queimador de álcool  
E-561-01



Alcohol Burner Wicks, spare parts  
Alcohol Burner Wicks, piezas de repuesto  
Queimador de álcool Wicks, peças de reposição  
E-561-02



Muffles  
Muffles  
Muffles  
Gr.3  
E-276-03

Gr.6  
E-276-

LABORATORIO

288

LABORATORY



Saw with silicone covered handle  
Sierra con mango cubierto de silicona  
Serra com cabo coberto de silicone  
E-550-01

Saw Blades: 0.25x3mm  
Hojas de sierra: 0.25x3 mm  
Lâminas de serra: 0,25x3 mm  
E-550-01A



Holder for brushes  
Soporte para cepillos  
Suporte para escovas  
E-560-01





Empire

## DENTAL ALLOYS DENTAL ALLOYS



E-555-01

Kera N

Dental alloy for ceramics, Nickel base (Ni-Cr)  
pack of 1 kg

Typical chemical elements in %

Ni	Cr	Mo	Al	Si
~63	25.75	11	>0.4	1.5

Kera N is a beryllium and iron-free Ni-Cr alloy. The strong oxides provides optimum metal/-ceramic bonding, one of the remarkable features is the high corrosion resistance.

Kera N s a berílio e aleación de Ni-Cr sin hierro. Los óxidos fuertes proporcionan un metal óptimo/-unión cerámica, una de las características notables es la alta resistencia a la corrosión.

Kera N é um berílio e liga de Ni-Cr sem ferro. Os óxidos fortes fornecem metal ideal / -ligação cerâmica, uma das características notáveis é a alta resistência à corrosão.

E-555-02

Kera C

Dental alloy for ceramics, Nickel base (Ni-Cr)  
pack of 1 kg

Typical chemical elements in %

Co	Cr	Mo	Mn	Al	Sr	W	Fe	V	Nb
~58	24.50	1	<1	<0.4	0.9	9	<1.5	2	2

Kera C is Co-Cr alloy for ceramics and is beryllium and nickel free, the strong oxides provide optimum metal/ceramic bonding, one of the remarkable features is the high corrosion resistance.

Aleación Co-Cr de Kera C para cerámica y es berílio y libre de níquel, los óxidos fuertes proporcionan óptimo unión metal / cerámica, uno de los notables características es la alta resistencia a la corrosión.

Liga de Co-Cr de Kera C s para cerâmica e é berílio e livres de níquel, os óxidos fortes fornecem um ótimo ligação metal / cerâmica, uma das mais notáveis características é a alta resistência à corrosão.

E-555-03

EDW

Soft dental alloy for composites, Nickel base(Ni-Cr)  
pack of 1 kg

Typical chemical elements in %

Co	Cr	Mo	Mn	Al	Si	W	Fe	C
~65	27.0	4.73	0.57		1.80		0.26	0.01

EDW is a beryllium free chrome/nickel alloy one of the remarkable features is the high corrosion resistance.

EDW es una aleación de cromo / níquel libre de berílio de las características notables es la alta resistencia a la corrosión.

EDW é uma liga de cromo / níquel livre de berílio das características notáveis é a alta resistência à corrosão.



E-555-04

### Robur 400

Partial denture alloy, Nickel free (Co-Cr)  
super hard, pack of 1 kg

Typical chemical elements in %

Co	Cr	Mo	Mn	Al	Si	W	Fe	C
65	29	6	0.6	<0.4	0.4	1	<1	0.5

Robour 400 is an extremely pure cast alloy on cobalt base, exclusively made of fresh and pre-tested ore. This is an important requirement for high histocompatibility.

Highest mechanical features and best cast ability make room for individual and esthetical denture creation. simple elaboration as well as good polishing an gloss results are typical.

Robour 400 es una aleación de fundición extremadamente pura en base de cobalto, exclusivamente hecha de mineral probado Este es un requisito importante para una alta histocompatibilidad.

Las características mechanical más altas y el mejor reparto capacidad de hacer espacio para individual y estética creación de dentadura elaboración simple, así como un buen pulido y un brillo son típicos.

Robour 400 é uma liga fundida extremamente pura base de cobalto, fabricada exclusivamente a partir de minério testado. Este é um requisito importante para alta histocompatibilidade.

Principais características mecânicas e melhor elenco capacidade de dar espaço para individual e estética criação de dentadura. elaboração simples, bem como bom polimento, um resultado de brilho é típico.

E-555-05

### Tener 350

Partial denture alloy, Nickel free (Co-Cr)  
super hard, pack of 1 kg

Typical chemical elements in %

Co	Cr	Mo	Mn	Al	Si	W	Fe	C
65	29	6	0.6	<0.4	0.4	1	<1	0.3

Tener 350 is an extremely pure cast alloy on cobalt base, exclusively made of fresh and pre-tested ore. This is an important requirement for high histocompatibility.

Highest mechanical features and best cast ability make room for individual and esthetical denture creation. simple elaboration as well as good polishing an gloss results are typical.

Tener 350 es una aleación de fundición extremadamente pura en base de cobalto, exclusivamente hecha de mineral probado Este es un requisito importante para una alta histocompatibilidad.

Las características mechanical más altas y el mejor reparto capacidad de hacer espacio para individual y estética creación de dentadura elaboración simple, así como un buen pulido y un brillo son típicos.

Tener 350 é uma liga fundida extremamente pura base de cobalto, fabricada exclusivamente a partir de minério testado. Este é um requisito importante para alta histocompatibilidade.

Principais características mecânicas e melhor elenco capacidade de dar espaço para individual e estética criação de dentadura. elaboração simples, bem como bom polimento, um resultado de brilho é típico.

E-555-06

### Tener IT

Partial denture alloy, Nickel free (Co-Cr)  
super hard, pack of 1 kg

Typical chemical elements in %

Co	Cr	Mo	Mn	Al	Si	W	Fe	C
65	29	6	0.6	<0.4	0.4	1	<1	0.15

Tener IT is an extremely pure cast alloy on cobalt base, exclusively made of fresh and pre-tested ore. This is an important requirement for high histocompatibility.

Highest mechanical features and best cast ability make room for individual and esthetical denture creation. simple elaboration as well as good polishing an gloss results are typical.

Tener IT es una aleación de fundición extremadamente pura en base de cobalto, exclusivamente hecha de mineral probado Este es un requisito importante para una alta histocompatibilidad.

Las características mechanical más altas y el mejor reparto capacidad de hacer espacio para individual y estética creación de dentadura elaboración simple, así como un buen pulido y un brillo son típicos.

Tener IT é uma liga fundida extremamente pura base de cobalto, fabricada exclusivamente a partir de minério testado. Este é um requisito importante para alta histocompatibilidade.

Principais características mecânicas e melhor elenco capacidade de dar espaço para individual e estética criação de dentadura. elaboração simples, bem como bom polimento, um resultado de brilho é típico.



Empire

**Cross Cut Fine (ISO- No.140)**

For delicate and difficult trimming of hard alloys, acrylic and ceramics

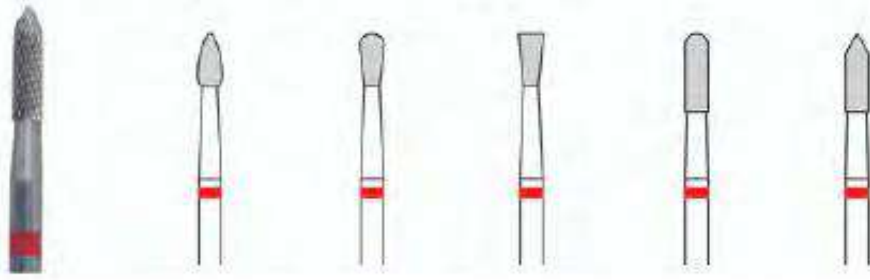

	E-558-05	E-558-06	E-558-07	E-558-08	E-558-09
Ø mm	2.3	2.3	2.3	2.3	2.3
L1 mm	5.5	5.5	5.5	8.0	8.0
L2 mm	45.0	45.0	45.0	45.0	45.0

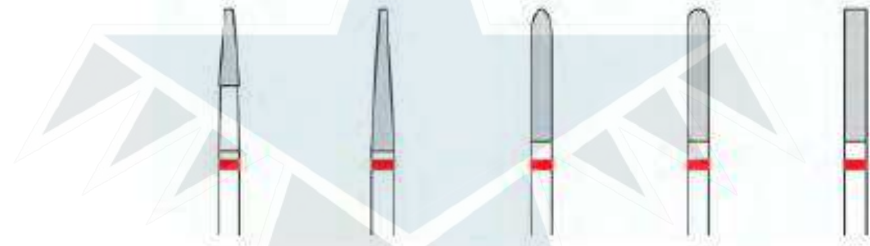

	E-558-10	E-558-11	E-558-12	E-558-13	E-558-14
Ø mm	2.3	2.3	2.3	2.3	2.3
L1 mm	8.0	15.0	14.0	14.0	14.0
L2 mm	45.0	45.0	45.0	45.0	45.0

Empire

**Cross Cut Fine (ISO- No.140)**

For delicate and difficult trimming of hard alloys, acrylic and ceramics

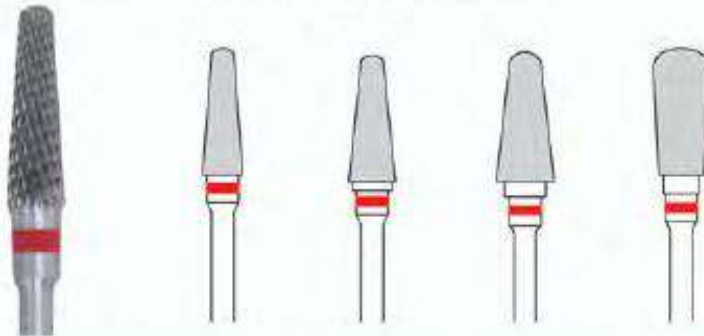

	E-558-15	E-558-16	E-558-17	E-558-18
Ø mm	4.0	5.0	6.0	6.0
L1 mm	13.5	13.5	13.5	13.0
L2 mm	52.0	52.0	52.0	52.0

**Cross Cut X-Fine (ISO- No.141)**

For fine, precise trimming of ceramics, precious metals and all non-precious alloys

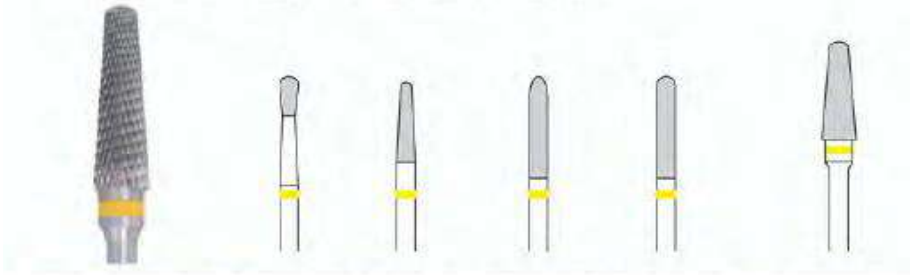

	E-558-19	E-558-20	E-558-21	E-558-22	E-558-23
Ø mm	2,3	2,3	2,3	2,3	4,0
L1 mm	5,5	11,5	14,0	14,0	13,5
L2 mm	45,0	45,0	45,0	45,0	52,0

**Cross Cut Coarse (ISO- No.220)**

For trimming large surfaces of acrylics, tray materials and plaster

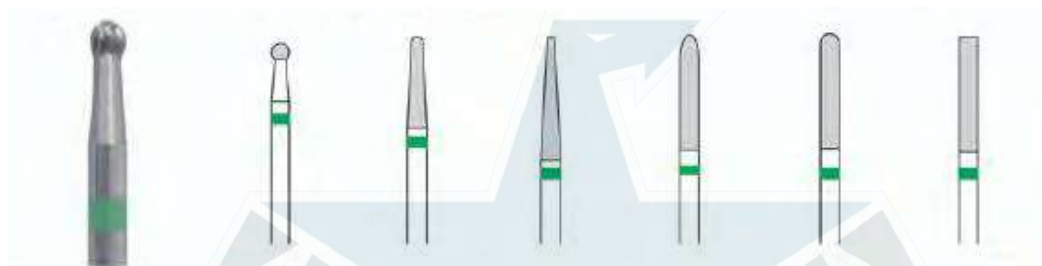

	E-558-24	E-558-25	E-558-26	E-558-27	E-558-28	E-558-29
Ø mm	2,3	2,3	2,3	2,3	2,3	2,3
L1 mm	2,3	11,0	15,5	2,3	14,0	14,0
L2 mm	45,0	45,0	45,0	45,0	45,0	45,0

**Cross Cut Coarse (ISO- No.220)**

For trimming large surfaces of acrylics, tray materials and plaster

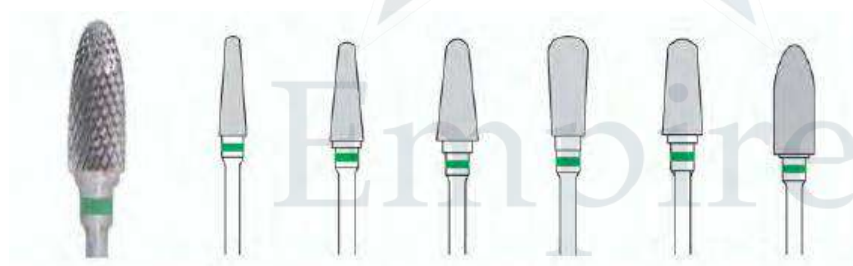

	E-558-30	E-558-31	E-558-32	E-558-33	E-558-34	E-558-35
Ø mm	4,0	5,0	6,0	6,0	6,0	6,0
L1 mm	13,5	13,5	13,5	13,0	13,0	14,0
L2 mm	52,0	52,0	52,0	52,0	52,0	52,0



**Cross Cut X-Coarse (ISO- No.224)**

The optimum for plaster-also wet plaster

	E-558-36	E-558-37
Ø mm	4,0	6,0
L1 mm	13,5	13,5
L2 mm	52,0	52,0

- DENTAL VETERINARY INSTRUMENTS
- INSTRUMENTOS VETERINARIOS DENTALES
- INSTRUMENTOS VETERINÁRIOS DENTÁRIOS



EMPIRE SURGICAL LTD (THE FUTURE OF HEALTHCARE)



# GRAYS MODIFIED MOUTH GAGS

## BOLSAS DE BOCA MODIFICADAS GRAYS

16cm for dog  
E-701-21



12.7cm For dog  
E-701-22



8.8cm For dog  
E-701-23



5.5cm For cat and dog  
E-701-24



2.7cm For cats  
E-701-25





Empire

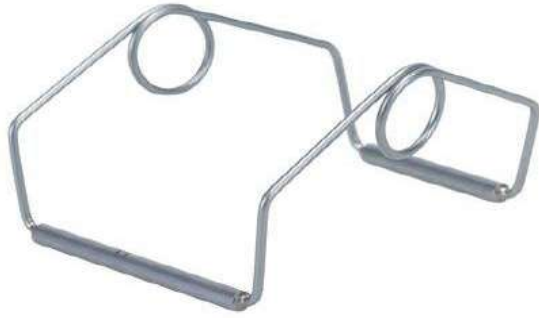

smith-baxter  
size 1 For dogs  
E-701-54



smith-baxter  
size 2 For dogs  
E-701-56



Lip retractor  
E-703-27



Fig	Ø	Code
0	10mm	E-202-10
1	12mm	E-202-12
2	14mm	E-202-14
3	16mm	E-202-16
4	18mm	E-202-18
5	20mm	E-202-20
6	22mm	E-202-22
7	24mm	E-202-24
8	26mm	E-202-26
9	28mm	E-202-28
10	30mm	E-202-30

Handles on page-----



# ELEVATORS FOR CATS AND DOGS

## ELEVADORES PARA GATOS Y PERROS

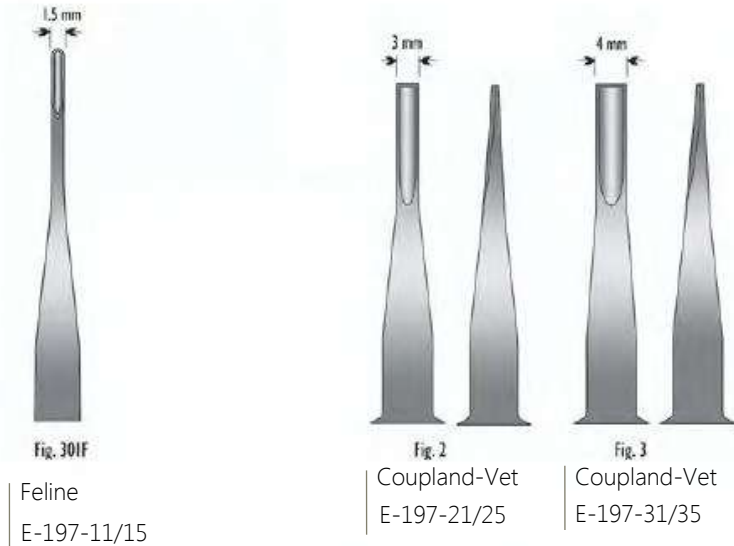
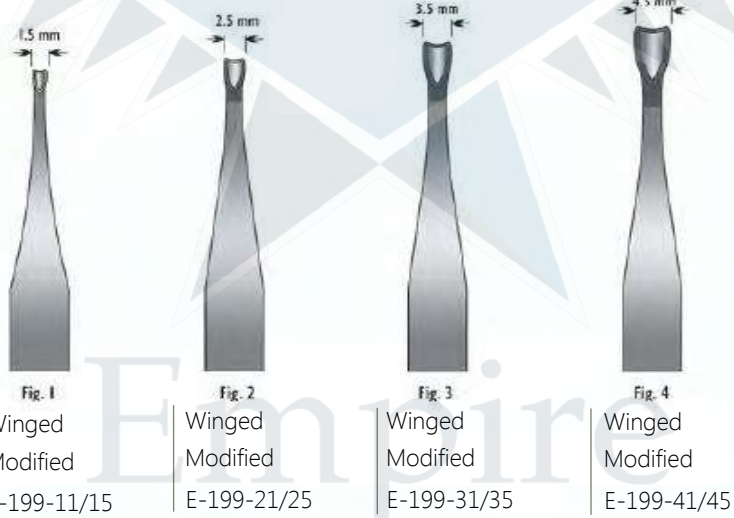

**Standard Handle**



**Slim Handle**



Empire



2mm E-177-20 For Cats  
3mm E-177-30 For Dogs  
4mm E-177-40 For Dogs



2mm E-178-20 For Cats  
3mm E-178-30 For Dogs  
4mm E-178-40 For Dogs



Fig. 1

E-177-01  
lower for cats



Fig. 2

E-177-02  
upper for cats



Fig. 1

E-177-03  
lower for dogs



Fig. 2

E-177-04  
upper for dogs



E-177-06  
Root Elevator



E-177-08  
Wedge Elevator



E-177-10  
Mini Periosteal Elevator



Fig. 151S  
Universal Incisor, Bicuspid,  
Lower, Pediatric  
E-611-151S



Fig. 151  
Universal Bicuspid,  
root, lower  
E-611-151



Fig. 150S  
Universal Incisor, Bicuspid,  
Lower, Pediatric  
E-611-150S



Fig. 69  
Upper or Lower,  
Fragment or Small Root  
E-611-69





Empire



Fig. 24  
Upper Molar,  
Universal,  
Hook Handle  
E-611-24



Fig. 62  
Upper or Lower,  
Universal, Incisor,  
Bicuspid, Deciduous  
E-611-62



Fig. 6  
Splitting &  
Separating  
E-611-06



Fig. 150  
Upper Incisor, Bicuspid,  
Root, Universal  
E-611-150



Fig. 65  
Upper Bicuspid/  
Incisor, Root  
Bayonet  
E-611-65



Jacquette Scaler  
#1S/1S (33/33)  
6.5mm  
E-413-1S/1S

Gracey Curette #13/14  
Solid Handle  
6.5mm  
E-413-13G/14G

Jacquette Scaler  
#2/3 (31/32)  
6.5mm  
E-413-2/3

Gracey Curette #11/12  
Solid Handle  
6.5mm  
E-413-11/12

Jacquette Scaler  
#2S/3S (34/35)  
6.5mm  
E-413-2S/3S

Columbia Curette #13/14  
Solid Handle  
E-413-13C/14C

Expro #23/  
Williamsr  
E-413-23

McCall Curette #13/14  
Solid Octagonal Handle  
E-413-13/14

Goldman-Fox  
Flat, Single Ended  
E-413-28  
(1-2-3-5-7-8-9-10)



# Empire PLUGGERS AND SPREADERS

## ENCHUFES Y ESPARCIDORES

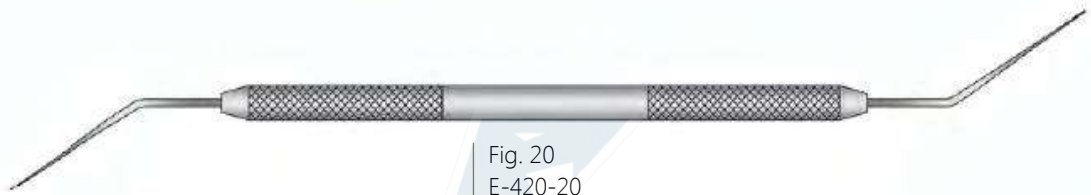

Fig. 20  
E-420-20  
Holmstrom



Fig. 35  
E-420-23  
Holmstrom

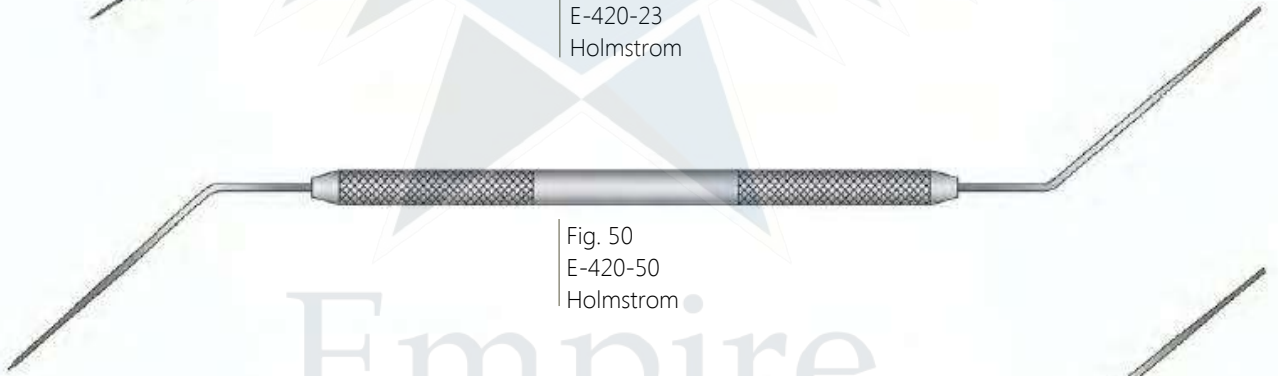

Fig. 50  
E-420-50  
Holmstrom

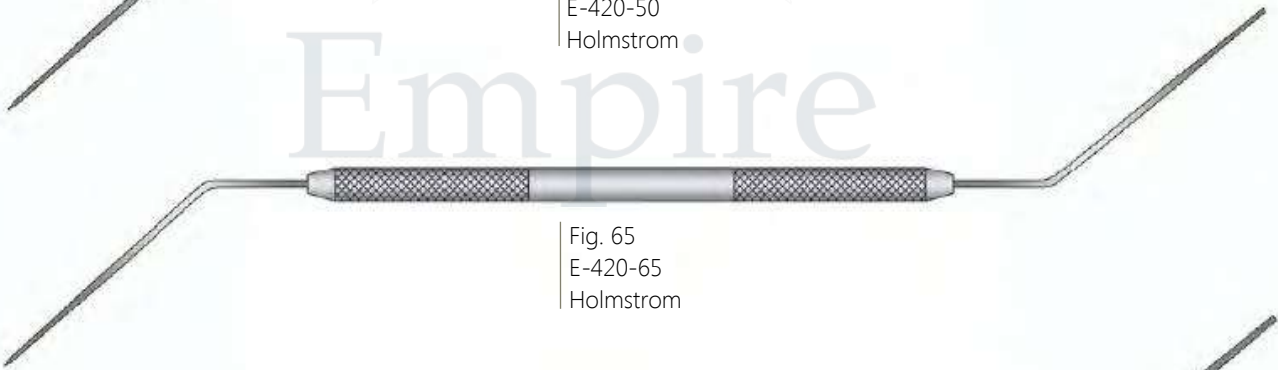

Fig. 65  
E-420-65  
Holmstrom



Fig. 90  
E-420-90  
Holmstrom



Table Top Rodent Mouth Gag  
E-1429-08



Twisted wire mouth gag  
E-705-79

Rodent Mouth Gag  
E-705-58



Rodent Mouth Gag  
E-705-77



Rodent Mouth Gag  
Retractor type  
E-705-56



Empire

**Cheek retractor**



55mm

- Cheek retractor
- 8 x 9mm  
E-705-84
- 14 x 11mm  
E-705-85
- 34 x 11mm  
E-705-86
- 40 x 5mm  
E-706-87



80mm

- Cheek retractor
- 22 x 15mm  
E-706-90
- 40 x 10mm  
E-706-91

Empire

**Mouth examination spatulas and tongue depressors**



9mm



E-283-01

9mm



E-283-04

10mm



E-283-06



9mm



E-283-10



**Tooth Rasps**

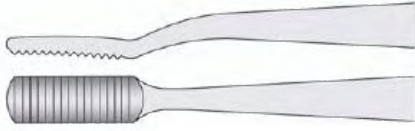

Fig, 1 **E-178-66** 180mm



Fig, 2 **E-178-67** 180mm

**Luxators**



Fig, 1 **E-190-74** Incisors



Fig, 2 **E-190-75** Incisors



Fig, 1 **E-190-76** Molars and Premolars



Fig, 2 **E-190-77** Molars and Premolars

**Extraction Forceps**



**E-142-25**  
155mm  
Molars and Premolars



**Tooth Cutter**



**E-142-27**  
185mm  
Molars and Premolars

- DENTAL KITS AND SETS
- KITS DENTALES Y SETS
- KITS DENTÁRIOS E CONJUNTOS

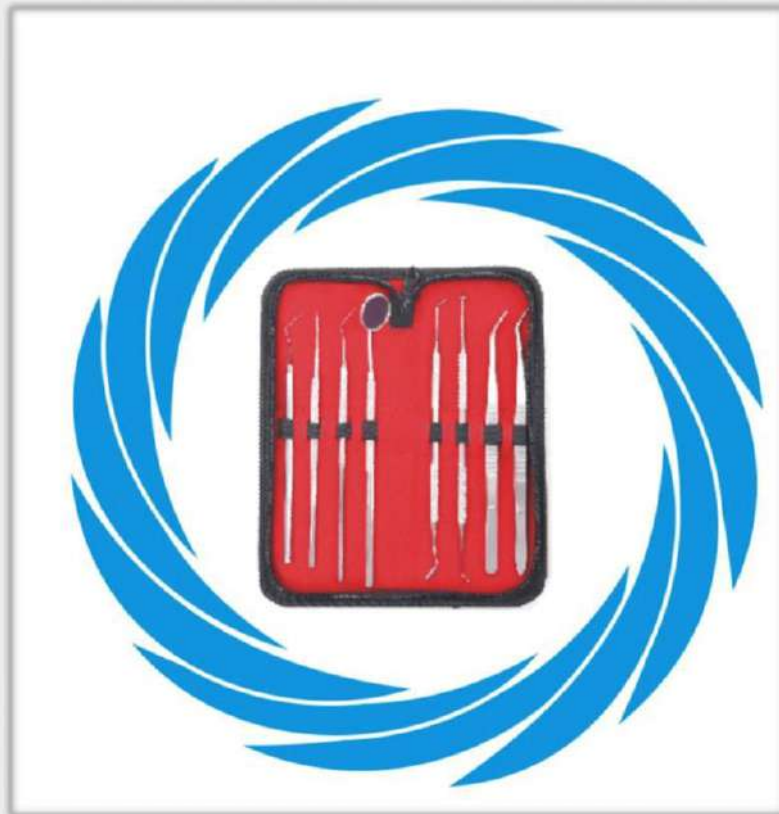

EMPIRE SURGICAL LTD (THE FUTURE OF HEALTHCARE)

# SURGICAL BASIC SET

## EX TRACTION FORCEPS 10PCS SET

### FUENTES DE EXTRACCIÓN 10 Stück SET



E-1184-15

- |                             |                            |
|-----------------------------|----------------------------|
| * 1 Upper central & canines | * 1 Obere Mitte & Eckzähne |
| * 1 Lower premolars         | * 1 Untere Prämolaren      |
| * 1 Upper molars, right     | * 1 Obere Molaren, rechts  |
| * 1 Upper molars, left      | * 1 Obere Molaren, links   |
| * 1 Upper third molars      | * 1 Obere dritte Molaren   |
| * 1 Lower molars            | * 1 Untere Backenzähne     |
| * 1 Lower incisors          | * 1 Untere Schneidezähne   |
| * 1 Upper roots             | * 1 Obere Wurzeln          |
| * 1 Upper third molars      | * 1 Obere dritte Molarens  |
| * 1 Lower molars            | * 1 Untere Backenzähne     |

## ORTHODONTIC PLIERS 10PCS SET

### ALICATES ORTODÓNTICOS 10 Stück

- |                                   |                                    |
|-----------------------------------|------------------------------------|
| * 1 Weingart utility plier        | * 1 Weingart Zange                 |
| * 1 Bracket removing plier        | * 1 Klammer entfernen Zange        |
| * 1 Bird Beak Plier               | * 1 Vogelschnabelzange             |
| * 1 Bird Beak Plier with cutter   | * 1 Vogel Schnabelzange mit Cutter |
| * 1 Pin & Ligature cutter         | * 1 Pin & Ligaturschneider         |
| * 1 Pin Placing cutter            | * 1 Pin Platzieren des Cutters     |
| * 1 Distal End Cutter             | * 1 Distaler Endschneider          |
| * 1 Nance Loop forming plier      | * 1 Nance Loop formende Zange      |
| * 1 Optical plier                 | * 1 Optische Zange                 |
| * 1 Posterior band removing plier | * 1 Posterior band removing plier  |

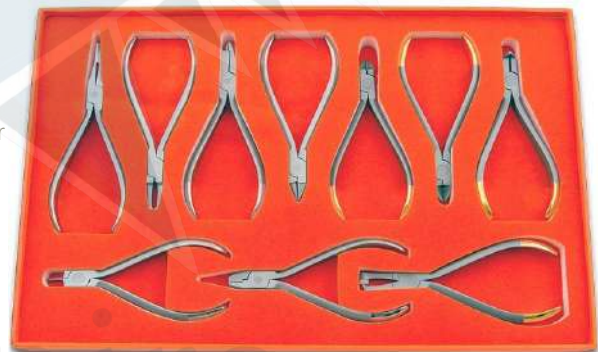

E-1185-03



E-1190-06

## STUDENT DENTAL KIT 05PCS SET

### KIT DENTAL ESTUDIANTIL 05 Stück

- |                            |                            |
|----------------------------|----------------------------|
| * 2 Scaler                 | * 2 Escalador              |
| * 1 Tartal remover         | * 1 Eliminador de Tartal   |
| * 1 Anti fog dental mirror | * 1 Espejo dental antivaho |
| * 1 Tweezer                | * 1 Tweezer                |



Empire

DENTAL KIT 08PCS SET  
Kit Dental 08 Stück SET



E-1190-07



E-1190-08

DENTAL SURGICAL KIT (TITANIUM)  
KIT QUIRÚRGICO DENTAL (TITANIO)

RUBBER DAM SET  
Juego De Damas De Goma



E-1191-03

ROOT ELEVATOR 09PCS SET  
ASCENSOR DE RAÍZ 09 Stück SET



E-1195-11



## BASIC DENTAL SURGERY SET

- \* Adson Forcep Serrated, 4 3/4"
- \* Adson Forcep 1x2 Teeth, 4 3/4"
- \* Bone File Double End
- \* College Plier #2
- \* Crile-Wood Needle Holder Tungsten Carbide, Serrated, 6"
- \* Explorer Single End, #17
- \* Explorer Single End, #23
- \* Gardner Chisel #1
- \* La Grange Scissor S-Shape, 4 1/2", 1 Blade Serrated
- \* Lucas Curette Double End, #86
- \* Mirror Handle Octagonal, Cone Socket
- \* Molt Periosteal Elevator #9
- \* Mouth Mirror Cone Socket, Magnifying, #4
- \* VMouth Mirror Cone Socket, Plane #4
- \* Orban Knife Double End, #1/2
- \* Scalpel Handle #3 Fits Blades 10, 11, 12, 15
- \* Surgical Blade Carbon, #11
- \* Surgical Blade Carbon, #15
- \* University of Minnesota Cheek Retractor Double End, 5 1/2"



E-1196-06



E-1197-06

## SUTURE REMOVAL SET

- \* College Plier #2
- \* Columbia Curette Double End, #13/14
- \* Explorer Double End, #5
- \* Littauer Stitch Scissor 5 1/2"
- \* Mirror Handle Round, Cone Socket
- \* Mouth Mirror Front Surface, #5



E-1185-05

## PLIER SET

- \* College Plier #2
- \* College Plier Serrated, #317
- \* College Plier Extra Fine, Serrated, Narrow, #317A
- \* College Plier Extra Fine, Serrated, Long, #317B
- \* College Plier Smooth, #317S
- \* College Plier Smooth, Forked Tip, #311
- \* Meriam Plier Serrated, #318
- \* Non-Pinch College Plier Serrated
- \* Non-Pinch College Plier Serrated, #49
- \* Non-Pinch College Plier Smooth
- \* Perry Plier #1
- \* Perry Plier Serrated, Curved, #312
- \* Self-Locking College Plier Grooved
- \* Self-Locking College Plier Serrated





Empire

## ORTHODONTIC ARCHWIRE ADJUSTMENT SET

- \* Bending Plier, Bird Beak
- \* Direct Bond Bracket Holder
- \* Distal End Cutter
- \* Hard Wire Cutter
- \* Ligature Director and Scaler
- \* Mathieu Plier
- \* Mirror Handle Round, Cone Socket
- \* Mouth Mirror Front Surface, #5
- \* Pin & Ligature Wire Cutter
- \* Three Jaw Offset Plier
- \* Weingart Utility Plier



Empire

E-1186-02



Empire

E-1189-04

## BASIC EXAMINATION SET I

- \* College Plier #2
- \* Explorer Double End, #5
- \* Explorer Single End, #6
- \* Explorer Single End, #17
- \* Explorer Single End, #23
- \* Mirror Handle Round, Cone Socket
- \* Mouth Mirror Front Surface, #5
- \* Probe Single End, C

## TOTAL RESTORATIVE SET

- \* Amalgam Carrier Tungsten Carbide, Double End, Medium/Large
- \* Amalgam Well
- \* Black Amalgam Plugger/Condenser Double End, Serrated (Marquette), #0/1
- \* Black Amalgam Plugger/Condenser Double End, Smooth, #1/2
- \* Burnisher Double End, #27/29
- \* Calcium Hydroxide Placer
- \* Cement Spatula #24
- \* Cleoid Discoid Carver Double End, #3/6
- \* College Plier #2
- \* Cord Packer Double End, Retraction Cord
- \* Excavator Double End, #18
- \* Hollenback Carver Double End, #1/2
- \* Hollenback Carver Double End, #3
- \* Hollenback Carver Double End, #3S
- \* Interproximal Carver Double End
- \* Iris Scissor Curved, 4 1/2"
- \* Miller Groovelok Articulating Paper Forcep Stainless, Grooved
- \* Mirror Handle Round, Cone Socket
- \* Mouth Mirror Front Surface, #5
- \* Plastic Filling Instrument Double End, #3
- \* Plastic Filling Instrument Double End, #4
- \* Probe/Explorer Probe 1-10mm/Explorer #23



Empire

E-1191-01

## CEMENT (CROWN SEAT) SET

- \* Cement Spatula #24
- \* College Plier #2
- \* Explorer Double End, #5
- \* Interproximal Carver Double End
- \* Miller Groovelok Articulating Paper Forcep Stainless, Grooved
- \* Mirror Handle Round, Cone Socket
- \* Mouth Mirror Front Surface, #5



E-1173-02



E-1174-02

## GRACEY CURETTE SET

- \* Gracey Curette Double End, #1/2
- \* Gracey Curette Double End, #3/4
- \* Gracey Curette Double End, #5/6
- \* Gracey Curette Double End, #7/8
- \* Gracey Curette Double End, #9/10
- \* Gracey Curette Double End, #11/12
- \* Gracey Curette Double End, #13/14
- \* Gracey Curette Double End, #15/16
- \* Gracey Curette Double End, #17/18

## PERIODONTAL INSTRUMENT SET I

- \* Coded Probe Single End, #12
- \* Columbia Curette Double End, #13/14
- \* Explorer Double End, #11/12
- \* Gracey Curette Double End, #1/2
- \* Gracey Curette Double End, #7/8
- \* Gracey Curette Double End, #11/12
- \* Gracey Curette Double End, #13/14
- \* Mirror Handle Round, Cone Socket
- \* Mouth Mirror Front Surface, #5
- \* Scaler Double End, #H6/H7
- \* Scaler Double End, #204S



E-1175-02



E-1176-02

## PERIODONTAL INSTRUMENT SET III

- \* Crane-Kaplan Pocket Marker#1
- \* Crane-Kaplan Pocket Marker#2
- \* Crane-Kaplan ScalerDouble End, #6
- \* Crile-Wood Needle HolderSerrated, 6"
- \* Goldman-Fox Knife#8
- \* Goldman-Fox ProbeSingle End, Round
- \* Goldman-Fox ScalerDouble End, #2
- \* Goldman-Fox ScalerDouble End, #3
- \* Goldman-Fox ScalerDouble End, #4
- \* Goldman-Fox ScissorCurved, Serrated, 5"
- \* Quimby Gum ScissorCurved, 5"
- \* ScalerSingle End, #3



Empire



Empire

E-1177-02

## SUTURE REMOVAL SET

- \* College Plier #2
- \* Columbia Curette Double End, #13/14
- \* Explorer Double End, #5
- \* Littauer Stitch Scissor 5 1/2"
- \* Mirror Handle Round, Cone Socket
- \* Mouth Mirror Front Surface, #5

## SMALL PROPHY SET

- \* Columbia Curette Double End, #13/14
- \* Explorer Double End, #5
- \* Gracey Curette Double End, #1/2
- \* Gracey Curette Double End, #5/6
- \* Mirror Handle Round, Cone Socket
- \* Mouth Mirror Front Surface, #5
- \* Scaler Double End, #H6/H7
- \* Scaler Double End, #204S
- \* UNC Probe Single End, #15
- \* WHO (PSR) Probe Single End



Empire

E-1178-02



Empire

E-1165-02

## EXTRACTING FORCEPS SET

- \* Childrens Extracting Forcep #150S
- \* Childrens Extracting Forcep #151S
- \* Extracting Forcep #1
- \* Extracting Forcep #10S
- \* Extracting Forcep #17
- \* Extracting Forcep #222
- \* Extracting Forcep #53L
- \* Extracting Forcep #53R

## ORTHODONTIC ARCHWIRE ADJUSTMENT SET

- \* Bending Plier, Bird Beak
- \* Direct Bond Bracket Holder
- \* Distal End Cutter
- \* Hard Wire Cutter
- \* Ligature Director and Scaler
- \* Mathieu Plier
- \* Mirror Handle Round, Cone Socket
- \* Mouth Mirror Front Surface, #5
- \* Pin & Ligature Wire Cutter
- \* Three Jaw Offset Plier
- \* Weingart Utility Plier



Empire

E-1168-02

## ORTHODONTIC ARCHWIRE ADJUSTMENT SET

- \* Bending Plier, Bird Beak
- \* Direct Bond Bracket Holder
- \* Distal End Cutter
- \* Hard Wire Cutter
- \* Ligature Director and Scaler
- \* Mathieu Plier
- \* Mirror Handle Round, Cone Socket
- \* Mouth Mirror Front Surface, #5
- \* Pin & Ligature Wire Cutter
- \* Three Jaw Offset Plier
- \* Weingart Utility Plier



Empire

E-1161-02



Empire

E-1164-02

## GRACEY CURETTE SET

- \* Gracey Curette Double End, #1/2
- \* Gracey Curette Double End, #3/4
- \* Gracey Curette Double End, #5/6
- \* Gracey Curette Double End, #7/8
- \* Gracey Curette Double End, #9/10
- \* Gracey Curette Double End, #11/12
- \* Gracey Curette Double End, #13/14
- \* Gracey Curette Double End, #15/16
- \* Gracey Curette Double End, #17/18

## CROWN AND BRIDGE SET

- \* Cement Spatula #24
- \* Coded Probe Single End, #12
- \* College Plier #2
- \* Cord Packer Double End, Retraction Cord
- \* Excavator Double End, #18
- \* Explorer Double End, #5
- \* Interproximal Carver Double End
- \* Iris Scissor Curved, 4 1/2"
- \* Miller Groovelok Articulating Paper Forcep Stainless, Grooved
- \* Mirror Handle Round, Cone Socket
- \* Mouth Mirror Front Surface, #5
- \* Plastic Filling Instrument Double End, #3



Empire

E-1162-02

X RAY AND  
NOVELTIES



Empire



Adult occlusal  
/ Child occlusal  
E-733-06



Adult occlusal  
/ Adult buccal  
E-733-08



Adult occlusal  
/ Child occlusal  
E-733-10



Child occlusal  
/ Child buccal  
E-733-12



Lingual upper  
/ Lingual lower  
E-733-14



Adult buccal  
/ Child buccal  
E-733-16



Buccal  
E-733-18

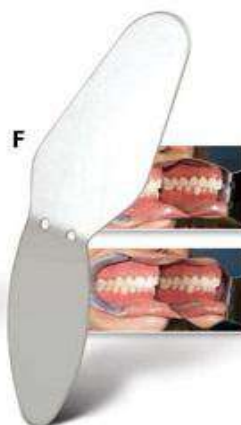
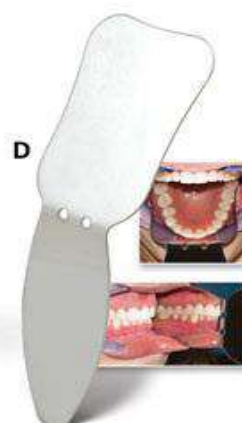
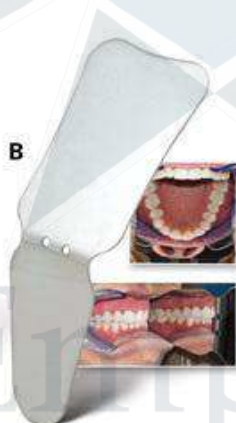
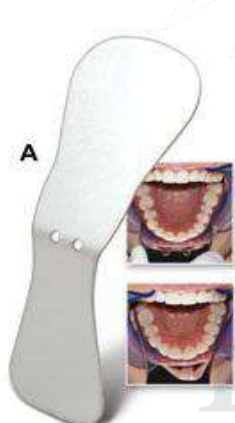



Empire

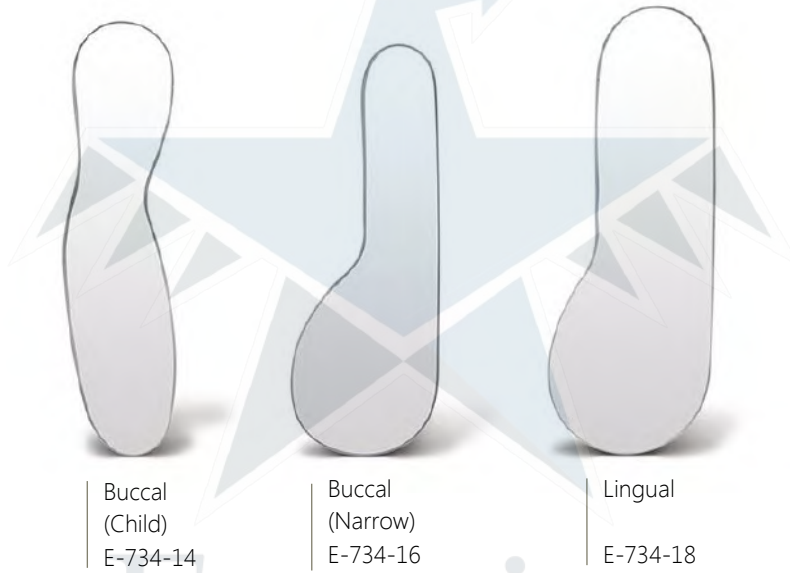

Mirror Handle Only  
Solo manija del espejo  
Apenas alça de espelho  
E-735-11



E-740-03  
 extraction forceps keychain  
 llavero de fórceps de extracción  
 keychain do fórceps da extração



E-740-12  
 mouth mirror keychain  
 boca espejo llavero  
 keychain do espelho de boca



E-740-04  
 extraction forceps keychain  
 llavero de fórceps de extracción  
 keychain do fórceps da extração



E-740-13  
 mouth mirror keychain  
 boca espejo llavero  
 keychain do espelho de boca



E-740-09  
 syringe keychain  
 jeringa llavero  
 keychain da seringa



E-740-14  
 mouth mirror keychain  
 boca espejo llavero  
 keychain do espelho de boca



E-740-10  
 syringe keychain  
 jeringa llavero  
 keychain da seringa



E-740-26  
 caliper keychain  
 llavero calibrador  
 keychain do compasso de calibre



E-740-04  
 mosquito forceps keychain  
 mosquito llavero  
 keychain do fórceps do mosquito



E-740-21  
 dental tooth keychain  
 llavero diente dental  
 chaveiro dente dental



E-740-04  
 impression tray keychain  
 bandeja de impresión llavero  
 keychain da bandeja da impressão



E-740-32  
 tweezer keychain  
 llavero tweezer  
 keychain do tweezer



NEPKIN HOLDERS  
SOPORTES DE SERVILETA



E-739-11



E-739-13



E-739-10



E-739-14



E-739-18

Empire

A	PAGE
ADSON, dissecting forceps	91
ADSON, tissue forceps	93
AINSWORTH, rubber-dam punch	32
Amalgam carriers	33
APICAL, root elevator	71
Applicator, bone	113
Applicators	36
ARNOLD, bone forceps	116
ARTHUR, root splinter forceps	69
AUSTIN, retractor	80, 118

B	
BACKHAUS, towel clamps	103
BARRAQUER, needle holder	98, 136
BARRY, elevators	71, 78
BAUMGARTNER, needle holder	100
BEALE, waxing instrument	29
BEEBEE, crown scissors	96
BEIN, elevators	70
BLACK, filling instruments	20
gingival margin trimmer	30
BLUMENTHAL, bone rongeurs	104
BÖHLER, bone rongeurs	105
BÖHM, telescopic crown forceps	145
BOLEY, caliper	153
Bone applicator	113
condenser	114
files	87
forceps	116
measuring gauge	120-121
mill	115
rongeurs	104-105
scraper	112
spreader	126
BOWDLER-HENRY, retractor	83, 119
BRAANEMARK, cheek retractor	81, 118
BREWER, clamp forceps	32
Brush holder	125
BUCHANAN, plugger	36
BUCK, perio file	50
BUFFALO, plaster knives	152
Burnishers	14, 15, 21
BUSER, raspatories	51, 85, 133

C	
Calcium hydroxide placer	15
Calipers	153
Carriers, amalgam-	33
Cartridge Syringe	79
Carving Instruments	28, 29
CASTROVIEJO, gauge	121
CASTROVIEJO, needle holders	98, 136
CAWOOD-MINNESOTA, cheek retractor	80, 118
Cement spatulas	31
Cheek retractors	80
Children tooth forceps	60-62, 68
Chisels	49, 127, 133
CHOMPRET, Syndesmotomes	75
Clamp forceps	32
Clamps, towel-	103
CLEOID-DISCOID, waxing instrument	28
COLUMBIA, scaler	45
Compactor	112, 114
Compo-Fill instruments	26
Cord packers	30
COUPLAND, elevators	72
CRANE KAPLAN, Pocket markers	12

CRILE MURRAY, needle holder	100
CRILE-WOOD, needle holders	99
Crown, remover	147
removing forceps	146-147
scissors	96
spreader	146
CRYER, elevators	71
CUMINE, scaler	47
Curettes, periodontal	42-43
sinus lift	123-125
titanium	52, 117

D	
DARBY-PERRY, excavators	22
DEAN, gum scissors	96
Dental Electrodes	106, 107
DERF, needle holder	100
Dissecting forceps	92, 96
Drilling guide	120
DYCAL, filling instruments	15

E	
EHRICKE, impression trays	108, 109
Electrode, dental	106, 107
Elevators,	86
root	68-76
sinus lift	128-131
Endo instruments	34
Endodontic Excavators	25
Endodontic instruments	36-39
Excavators	22-25
Explorer Tips	8
Explorers	6-7
Extracting forceps, American pattern	64-68
English pattern	54-63
for children	60-62, 68

F	
FAHNENSTOCK, wax knives	152
FARABEUF, retractor	80
Files, bone	87
perio	50
Filling instruments	14-20, 26
remover	30
Filter for sterilization container	139
Flat nose pliers	144
FLOHR, elevators	70
Forceps, articulating paper	12
children	60-62, 68
clamp	32
crown removing	146-147
dissecting	90, 91
extracting	54-68
heamostatic	102-103
root splinter	69
tissue	92, 93
FRAHM, finishing instrument	28
FRAZIER, suction cannula	89
FREER, elevator	86
FRIEDMANN, bone rongeurs	104
Furcation Probe	10

G	
Gauze packers	30
Gauges	120-121
GILLIES, tissue forceps	93
Gingival margin trimmers	30
cord packers	30



Gingivectomy knives	48
GLICK, root canal plugger	37
endo excavator	25
GLICKMAN, raspatories	133
GOLDMAN-FOX, gum scissors	94
curettes	47
gingivectomy knives	48
raspatory	51, 85
perio probe	10, 11
GOSLEE, flat nose pliers	144
GRACEY, curettes	42, 43
GRITMAN, plaster knife	152
Gum scissors	94-96

## H

Haemostatic forceps	102, 103
HALSTEAD-MOSQUITO, haemostatic forceps	102
Handles, mirror	9
scalpel	88
HARTMANN, Hohlmeißelzange	105
HEIDBRINK, elevators	74
HEIDEMANN, spatula	27
HEMINGWAY sharp spoon	87
HILGER, cheek retractor	80
HIRSCHFELD, perio files	50
Holder for brushes	125
Holding tweezers	122
HOLLENBACK, filling instruments	20
waxing instruments	28
HOPSON, filling instrument	15
HOWARTH, elevator	86
HYGIENIST, scaler	44
HYLIN, elevator	73
waxing instrument	150

## I

Impression trays	108, 109
Implant holding tweezers	122
INDIANA UNIVERSITY, scaler	46
Instrument oil	97
Instrument Trays	140-143
INTERPROXIMAL, waxing-instrument	29
IRIS, gum scissors	94
IVORY, rubber-dam punch	32
IWANSON, Calipper	153

## J

JONES, towel clamp	103
JOSEPH, gum scissors	95

## K

KELLY, gum scissors	94
haemostatic forceps	103
KIRKLAND, gingivectomy knife	48
KLEIN, tooth forceps	62
Knives, gingivectomy	48
plaster	152
wax	152
KOCHER-LANGENBECK, retractor	83

## L

LaGRANGE, gingiva scissors	94
LANGENBECK, retractors	83
LANGER, curettes	46
LeCRON, waxing instruments	150
LICHTENBERG, needle holder	100

Ligature scissors	95
LINDO LEVIAN, luxators	75
Lip retractor	81
LOCKLIN, gum scissors	96
LONDON-COLLEGE, tooth tweezers	12
LUCAS, sharp spoons	87
LUER, bone rongeurs	104
LUNIATSCHECK, gauze packers	30
Luxators	75-77, 135

## M

Mallets	84
Mandibular channel retractor	83, 119
Margin trimmers	30
MATHIEU, needle holders	99
Matrix retainers	33
Matrixband	33
MAYO-HEGAR, needle holders	99
MAZOUCH, crown spreader	147
McCALL, curettes	46
McINDOE, dissecting forceps	91
Measuring gauges	120-121
Measuring probes	10, 11
Membrane placing instrument	133
MERIAM, tooth tweezers	12
METZENBAUM, dissecting scissors	96
Micro mirrors	8
Micro needle holders	136-137
scissors	137
tweezers	136-137
MICRO-MOSQUITO, artery forceps	102
MIDDELDORPF, retractors	82
MILLER, articulating paper forceps	12
bone files	87
MINNESOTA, retractor	80, 118
Mirror, handles	9
mouth	8
MITCHEL, scaler	47
MOLT, mouth gag	81
MOLT, raspatories	51, 85
MORTENSON, filling instrument	8
Mouth gag	80
mirrors	8
mirror handles	9
retractors	80, 118
Muffles	153

## N

NABERS, perio probe	10
Needle holders	98-100, 136-137
NYSTROEM, carving instrument	29

## O

OBWEGESER, channel retractor	83, 119
ramus retractor	82, 119
raspatory	86
OCHSENBEIN, chisel	48, 87, 133
OLSEN-HEGAR, needle holders	99
ORBAN, chisel	133
gnigvectomy knife	48
ORINGER, mouth retractor	81
Osteotomes	127

## P

Papilla elevator	133
Parallel drilling guide	120
PEESO, wire bending pliers	144

Perio files	50
Perio probes	10, 11
Periodontal chisels	49
Periodontal knives	48
Periosteal elevators	51, 85, 86
Periotomes	134
PERRY, tooth tweezers	12
PK THOMAS, waxing instruments	148-149
Placing instrument	15, 133
PLANATOR, filling instrument	19
Plaster knives	152
spatulas	152
Plastic filling instruments	14-20, 26
Pluggers	20
root canal	36-38
POTTS-SMITH, Forceps	90, 92
PRICHARD, raspatories	51, 85
Probes, measuring	10, 11
PROVIDENCE-HOSPITAL, haemostatic forceps	103
Punch forceps, rubber-dam	32

**R**

Ramus retractor	82
Raspatories	51, 85-86, 133
Remover, filling-	30
Crown	119
Retractors	80-83, 119
Retractors, cheek	80, 118
lip	81
mouth	80, 118
tongue	81
RHODES BACK-ACTION, chisel	48, 133
RICHTER, steamer net	151
ROGHE, plaster spatula	152
Ronguers, bone	104, 105
Root canal instruments	36-39
Root canal plugger	36-38
Root canal spreader	37-38
Root elevators	70-78
Root splinter forceps	69
Rubber-dam instruments	32

**S**

Saw	153
Saw blade	153
Scalers	44-47
Scalpel handles	88
SCHLUGER, perio files	50
Scissors, crown	96
gingiva	94
gum	94-96
ligature	95
micro	136-137
titanium	137
universal	96
wire cutting	96
SELDIN, raspatory	86
root elevator	71
SEMKEN, forceps	90, 92
Sharp spoon	87
Sinus lift currettes	123-125
elevators	144-147
SMITH-RAMUS, forceps	116
Spatulas, cement	31
plaster	124
SPENCER, ligature scissors	95
Splinter forceps	69
Steamer net	123

Sterilization container	111
STERNBERG, lip retractor	81
STIEGLITZ, root splinter forceps	69
STOKE, rubber-dam punch	32
Suction tubes	89, 113
SUGARMAN, perio files	50
Suture tweezers	36
Syndesmotomes	75
Syringes	79

**T**

TAYLOR, scaler	44
Telescopic crown forceps	145
THYMOZIM, applicators	36
Tips, explorer-	8
Tissue forceps	92-93
Titanium currettes	52
Titanium instruments	137
TOFFELMIRE, matrix retainer	33
Tongue holder	81
Towel clamps	103
TOWNER, scaler	44
Trays for instruments	140-143
Trays, impression-	114-115
Trephines	132
Tubes, suction	89, 113
Tunneling instruments	49
TUFT, waxing instrument	29
Tweezers, endodontic	39
implant holding	122
titanium	137
tooth	12
suture	36

**U**

Universal pliers	145
scissors	95
scalars	45, 52

**V**

Vestibulum retractor	81
----------------------	----

**W**

WAGNER, gum scissors	95
WALDSACHS, universal pliers	145
WARD, filling instruments	20
waxing instruments	28
WARWICK-JAMES, elevators	72
Wash trays	140-143
Wax knives	152
Waxing instruments	28, 29, 148-150
WESTCOTT, burnishers	21, 26
WHITE, excavators	22
burnishers	21
WHO, perio probes	11
WIEDER, retractor	80
WILAND, waxing instrument	28
WILLIAMS, filling instrument	20
perio probe	10, 11
WILLIGER, elevator	86
raspatory	85
WINTER, elevators	78
Wire bending pliers	144
scissors	95
WITZEL, forceps	69

**Z**

ZAHLE, waxing instrument	150
--------------------------	-----

A	SEITE
Abdampfnetz	151
Abdrucklöffel	108, 109
Abhalter	80
Abnehmezange	146, 147
Absaugkanülen	89, 113
ADSON, anatomische Pinzette	91
ADSON, chirurgische Pinzette	93
AINSWORTH, Kofferdam-Lochzange	32
Amalgam-Instrumente	14-20
-Applikatoren	33
Anatomische Pinzetten	90, 91
Amerikanische Zahnzangen	64-68
Ampullen Spritze	79
APICAL, Wurzelheber	71
Applikatoren	36
ARNOLD Knochenzange	116
Arterienklemmen	102, 103
ARTHUR, Wurzelsplitterzange	69
Artikulationspinzette	12
Aufwachsinstrumente	148-149
AUSTIN, Wundhaken	80, 118

B	
BACKHAUS, Tuchklemme	103
BARRAQUER, Nadelhalter	98, 136
BARRY, Wurzelheber	71, 78
BAUMGARTNER, Nadelhalter	100
BEALE, Modellierinstrument	29
BEEBEE, Kronenschere	96
BEIN, Wurzelheber	70
BLACK, Füllungsinstrument	20
Gingivalrandschräger	30
BLUMENTHAL, Hohlmeißelzange	104
BÖHLER, Hohlmeißelzange	105
BÖHM, Teleskopkronenzange	145
Bohrhilfe	120
BOLEY, Messlehre	153
BOWDLER-HENRY, Wundhaken	83
BRAANEMARK, Mundvorhofhaken	81, 118
BREWER, Klammerzange	32
BUCHANAN Wurzelkanalstopfer	36
BUCK, Parodontalfeile	50
BUFFALO, Gipsmesser	152
BUSER, Raspatorium	51, 85, 133

C	
Calcium Hydroxid Platzierinstrument	15
CASTROVIEJO, Messzirkel	121
Nadelhalter	98, 137
CAWOOD-MINNESOTA, Wangenhalter	80, 118
Chirurgische -Pinzetten	92, 93
CHOMPRET, Syndesmotom	75
CLEOID-DISCOID, Modellierinstrument	28
COLUMBIA, Kürette	45
Compo Fill Instrumente	26
COUPLAND, Wurzelheber	72
CRANE KAPLAN, Taschenmarkierungspinzette	12
CRILE MURRAY, Nadelhalter	100
CRILE-WOOD, Nadelhalter	99
CRYER, Wurzelheber	71
CUMINE, Zahnreiniger	47

D	
DARBY-PERRY, Excavatoren	22
DEAN, Zahnfleischschere	96
Dental-Elektroden	106, 107
DERF, Nadelhalter	100

DISCOID-CLEOID, Modellierinstrumente	28
Drahtbiegeezangen	144
Drahtscheren	96
DYCAL, Füllungsinstrumente	15

E	
EHRICKE, Abdrucklöffel	108, 109
Elektroden	106, 107
Elevatoren	86
Sinus Lift	128-131
Endodontie Instrumente	36-39
Exkavatoren	22-25

F	
Fadenstopfer	30
FAHNENSTOCK, Wachsmesser	152
FARABEUF, Wundhaken	80
Feilen, Knochen-	87
Parodontal	50
Filter f. Sterilisationscontainer	139
Flachzangen	144
FLOHR, Wurzelheber	70
FRAHM, Modellierinstrumente	28
FRAZIER, Saugkanülen	89
FREER, Elevator	86
FRIEDMANN, Hohlmeißelzange	104
Füllungsentferner	30
Füllungsinstrumente	14-20, 26
Furkationssonde	10

G	
GILLIES, chirurgische Pinzette	93
Gingivalrandschräger	30
Gingivektomie Messer	48
Gips -Messer -Spatel	152
GLICK, Exkavator	25
Wurzelkanalstopfer	37
GICKMANN, Raspatorium	51, 85, 133
GOLDMAN-FOX, Gingivektomie Messer	48
Kürette	47
Raspatorium	51,85
Parodontometer	10,11
Zahnfleischschere	94
GOSLEE, Flachzange	144
GRACEY, Küretten	42,43
Granulat Stopfer	114
Griffe, Spiegel-	9
Skalpelli-	88
GRITMAN, Gipsmesser	152

H	
HALSTEAD-MOSQUITO, Arterienklemme	102
Hammer	84
HARTMANN, Hohlmeißelzangen	105
HEIDBRINK, Wurzelheber	74
HEIDEMANN Spatel	27
HEMINGWAY, scharfe Löffel	87
HILGER, Wangenabhalter	80
HIRSCHFELD, Parodontalfeilen	50
Hohlmeißelzangen	104, 105
HOLLENBACK, Füllungsinstrumente	20
Modellierinstrumente	28
HOPSON, Füllungsinstrument	15
HOWARTH, Elevator	86
HYGIENIST, Scaler	44
HYLIN, Modellierinstrument	150
Wurzelheber	73

<b>I</b>	
Implantat Haltepinzetten	122
INDIANA UNIVERSITY, Scaler	46
Instrumenten Öl	97
Instrumenten-Trays	140-143
INTERPROXIMAL, Modellierinstrument	29
IRIS, Zahnfleissschere	94
IVORY, Kofferdamzange	32
IWANSON, Tasterzirkel	153

<b>J</b>	
JONES, Tuchklemme	103
JOSEPH, Zahnfleissschere	95

<b>K</b>	
KELLY, Arterienklemme	103
Zahnfleissschere	94
KIRKLAND, Gingivektomie Messer	48
Kinderzahnzangen	60-62, 68
Klammernzange	32
KLEIN, Kinderzahnzangen	62
Klemmen, -Arterien	102, 103
Tuch-	103
Knochenfeilen	87
Knochenapplikatoren	113
Knochenmessinstrumente	120-121
Knochenmühle	115
Knochenschaber	112
Knochenspreizer	126
Knochenstopfer	112, 114
Knochenzangen	116
KOCHER-LANGENBECK, Wundhaken	83
Kofferdam-Instrumente	32
Krallenheber	73
Kronen, -abnehmezange	146-147
-aufbieger	146
-entferner	147
-scheren	96
Küretten	42-43
Sinus lift	123-125
Titan-	52, 117
Küvetten	153

<b>L</b>	
LaGRANGE, Gingiva-Schere	94
LANGENBECK, Wundhaken	83
LANGER, Küretten	46
LeCRON, Modellierinstrument	150
LICHTENBERG, Nadelhalter	100
Ligaturschere	95
LINDO LEVIAN, Luxatoren	75
Lippenhalter	81
Lochzange, Kofferdam	32
LOCKLIN, Zahnfleissschere	96
Löffel, scharfe	87
LONDON-COLLEGE, Zahnpinzette	12
LUCAS, scharfer Löffel	87
LUER, Hohlmeißelzange	104
LUNIATSCHEK, Tamponstopfer	30
Luxatoren	75-77, 135

<b>M</b>	
MATHIEU, Nadelhalter	99
Matrizenband	33
Matrizenspanner	33
MAYO-HEGAR, Nadelhalter	99
MAZOUCH, Kronenaufbieger	147
McCALL, Küretten	46

McINDOE, anatomische Pinzette	91
Meißel, Knochen-	127, 133
Parodontal-	49, 133
Membran Platzierinstrument	133
MERIAM, Zahnpinzette	12
Messer, Gingivektomie-	48
Parodontal-	48
Wachs-	152
Messlehre	153
Messsonden	10, 11
Messzirkel	153
METZENBAUM, Präparierschere	96
MICRO-MOSQUITO, Arterienklemme	102
MIDDELDORPF, Wangenhalter	82
Mikro Nadelhalter	136-137
Mikro Pinzette	136-137
MILLER, Artikulationspinzette	12
Knochenfeilen	87
MINNESOTA, Wangenhalter	80, 118
MITCHEL, Zahnreiniger	47
Modellierinstrumente	28-29, 148-150
Modelliermesser	150
Modelliersäge	153
MOLT, Raspatorium	51, 85
Mundsperrer	81
MORTENSON, Füllungsinstrument	20, 26
Muffeln	153
Mund -haken	80, 118
-sperrer	81
-spiegel	8
-spiegelgriffe	9
-vorhofhaken	81, 118
-winkelhalter	80, 118

<b>N</b>	
NABERS, Parodontometer	10
Nadelhalter	98-100, 152-153
Nahtpinzette	36
NYSTROEM, Modellierinstrument	29

<b>O</b>	
OBWEGESER, Progeniehaken	83, 119
Ramushaken	82, 119
Raspatorium	86
OCHSENBEIN, Parodontalmeißel	48, 87, 133
OLSEN-HEGAR, Nadelhalter	99
ORBAN, Gingivektomie Messer	48
Meißel	133
ORINGER, Mundhaken	81
Osteotome	127

<b>P</b>	
Papillen Elevator	133
Parallel Bohrhilfe	120
Parodontalfeilen	50
Parodontalmeißel	49
Parodontalmesser	48
Parodontometer	10, 11
PEESO, Drahtbiegezange	144
Periotome	134
PERRY, Zahnpinzette	12
Pinselfalter	153
Pinzette, anatomisch	90, 91
Artikulations-	12
chirurgisch	92, 93
Endodontie	39
Implantat Halte-	122
Naht-	36
Zahn-	12

PK THOMAS, Modellierinstrumente	148-149
PLANATOR, Füllungsinstrument	19
Platzierinstrument	15, 133
Polierinstrumente	21
POTTS-SMITH, Pinzette	90, 92
Präparierschere	96
PRICHARD, Raspatorium	51, 85
PROVIDENCE-HOSPITAL, Arterienklemme	103
Provisorien Abnehmezangen	146

## R

Ramushaken	82
Raspatorien	51, 85-86, 133
RHODES BACK-ACTION, Meißel	48, 133
RICHTER, Abdampfnetz	151
ROGHE, Gipsspatel	152

## S

Säge	153
Sägeblätter	153
Saugkanülen	89, 113
Scaler	44-47
Scharfe Löffel	87
Scheren,	94-96
Draht-	96
Kronen-	96
Ligatur-	95
Mikro-	136-137
Präparier-	95
Titan-	137
Universal-	96
Zahnfleisch-	94-96
SCHLUGER, Parodontalfeile	50
SELDIN, Raspatorium	86
Wurzelhebe	71
SEMKEN, Pinzetten	90, 92
Sinus Lift, Elevatoren	128-131
Küretten	123-125
Skalpellgriffe	88
SMITH-RAMUS, Knochenzange	116
Sonden, Zahn-	6, 7
Parodontal-	10, 11
Sondenspitzen	8
Spatel, Gips-	152
Zement-	31
SPENCER, Ligaturschere	95
Spiegel, -griffe,	9
Mund-	8
Spritzen	79
Sterilisationscontainer	139
STERNBERG, Lippenhalter	81
STIEGLITZ, Wurzelsplitterzange	69
STOKE, Kofferdam-Klammernzange	32
Stopfer, Knochen-	114
Tampon-	30
Strabismuschere	94
SUGARMAN, Parodontalfeile	50
Syndesmotome	75

## T

Tamponstopfer	30
Taschenmarkierungspinzette	12
Taschenmesssonden	10, 11
Tasterzirkel	153
TAYLOR, Kürette	44
Teleskopkronenzangen	145
THYMOZIM, Applikatoren	36
Titan Küretten	52, 117

TOFFLEMIRE, Matrizenspanner	33
TOWNER, Scaler	44
Trays	140-143
Trepäne	132
Tuchklemmen	103
TUFT, Modellierinstrument	29
Tunnelierinstrument	49

## U

Universal -biegezange	145
-schere	96
-scaler	45, 52

## V

Vestibulumhaken	81
-----------------	----

## W

Wachsmesser	152
WAGNER, Zahnfleischschere	95
WALDSACHS, Universalbiegezange	145
Wangenhalter	80
WARD, Füllungsinstrument	20
Modellierinstrument	28
WARWICK-JAMES, Wurzelheber	72
Wasch-Trays	140-143
WESTCOTT, Polierinstrumente	21, 26
WHITE, Excavatoren	22
Polierinstrumente	21
WHO Parodontalsonde	11
WIEDER, Mundhaken	80
WILAND, Modellierinstrument	28
WILLIAMS, Füllungsinstrument	20
Parodontometer	10, 11
WILLIGER, Elevatorium	86
Raspatorien	85
WINTER, Wurzelheber	78
WITZEL, Wurzelzange	69
Wundhaken	80-83, 119
Wurzelheber	70-78
Wurzelkanalinstrumente	36-39
Wurzelkanalspreizer	37-38
Wurzelkanalstopfer	36-38
Wurzelspitzenheber	74
Wurzelsplitterzange	69

## Z

ZÄHLE, Modellierinstrument	150
Zahnfleischscheren	94-96
Zahn -pinzetten,	12
-reiniger	47
-sonden	6-7
-sondenspitzen	8
-zangen, amerikanisch	64-68
englisch	54-63
Kinder-	60-62, 68
Zangen, Drahtbiege-	144
Extraktions-	54-68
Flach-	144
Hohlmeißel-	104-105
Kinderzahn-	60-62, 68
Knochen-	116
Kofferdam-	32
Teleskop-	145
Wurzelsplitter-	69
Zementspatel	31
Zungenhalter	81



ART.-NR.	PAGE/SEITE				
100/...	6	162/0 2	28	190/3STF	77
101/...	6	162/3-6	28	190/45C-ED	76,135
101/16	37	162/78	28	190/45ST-ED	76,135
101/16B	37	162/7A	29	190/4C	77
102/...	6	162/J2	29	190/4C-ED	76,135
103/...	7	162/W...	28	190/4CF	77
104/...	8	163/W1	20	190/4ST	77
105/...	7	163/W2	20	190/4ST-ED	76,135
106/...	7	163/W3	20	190/4STF	77
107/...	7	164/...	20	190/5C	77
108/...	37	165/1 - 5	148	190/5CF	77
110/...	14-15	166/1 - 5	149	190/5ST	77
110/CHP	14	170/1	30	190/5STF	77
111/...	16	170/2	30	190/6 - 7	70
112/...	16	171/77 - 78	30	190/B50 - B51	71
113/...	17	171/79 - 80	30	190/L1C-ED	76,135
114/...	18-19	173/2	29	190/L1ST-ED	76,135
115/...	19	173/28 - 29	30	190/L2C-ED	76,135
116/...	27	173/28 - 29R	30	190/L2ST-ED	76,135
117/1	30	173/4	30	191/...	78
118/1	36	173/5	30	192/01 - 03	74
118/2	36	173/6	30	192/04 - 06	74
118/B1	36	173/7	30	192/1 - 3	72
118/B2	36	173/8	30	192/11 - 13	74
118/GL1	37	174/...	98,136	192/5 - 8	75
118/P...	38	174/80T - 83T	137	193/301 - 303	71
118/S...	38	175/...	99-100	195/...	89
119/22	147	180/1	12	200/0	9
119/3	147	180/10	12	200/06	8
119/3A	147	180/5	12	200/08	8
119/3B	147	180/5D	12	200/1 - 5	9
119/3C	147	180/6	12	200/11	8
119/6	147	180/68	36	200/12	8
119/7	147	180/8	12	200/51	9
119/8AM	146	180/9	12	200/51M	9
119/8E	146	181/2	12	200/6	8
119/8OK	146	181/3	12	200/7 - 7A	80
119/8UK	146	181/4	36	200/8	8
121/C	47	182/...	90-91	201/10 - 30	8
121/M	47	183/...	92-93	210/1 - 4	96
130/1	87	184/20	136	215/1 - 2	153
130/2	87	184/20T	137	215/4	153
130/3	87	184/21	136	215/6 - 8	121
134/...	22-25	184/24	136	217/4	95
134/31L	25,35	184/24T	137	218/4	95
134/32L	25,35	184/25	136	220/1	94
134/33L	25,35	184/41	35	220/1SC	94
134/GL2	25,35	184/42	35	220/2	94
135/...	22-25	184/43	35	220/2SC	94
135/31L	25,35	184/44	35	229/1 - 4	96
135/32L	25,35	184/50T	122	230/1	95
135/33L	25,35	184/51	122	230/2	95
135/GL2	25,35	184/51T	122	235/3	95
135/PT55	25,35	184/52	122	235/4	95
136/...	104-105	184/52T	122	236/2	96
137/1	105	185/...	88	240/1	94
140/...	31	190/1 - 4	70	240/1SC	94
145/...	32	190/11 - 12	73	240/2	94
150/...	21	190/13 - 14	71	240/2SC	94
152/...	20	190/15 - 17	72	242/3	96
160/...	28-29	190/22 - 24	75	245/1	94
161/3	20	190/31 - 34	73	245/1SC	94
161/4	20	190/3C	77	250/0	94
161/H...	28	190/3C-ED	76,135	250/OSC	94
161/W	29	190/3CF	77	250/1	94
162/0	20	190/3ST	77	250/1SC	94
162/1	28	190/3ST-ED	76,135	250/20 - 22	95
				250/5	96
				250/5TC	96
				251/31T - 34T	153
				255/...	145
				270/...	152
				275/...	152
				276/3 - 6	153
				280/1 - 5	150
				290/1 - 2	102
				290/11 - 12	102
				290/14 - 15	102
				290/31 - 32	103
				290/35 - 36	103
				291/...	102
				298/1	103
				298/31	103
				298/32	103
				300/...	106-107
				301/...	106-107
				315/1	34
				315/2	34
				315/3	34
				315/4	34
				315/5	34
				320/...	34
				330/1	84
				330/3	84
				332/41	87
				332/42	87
				335/06	86
				335/2	114
				335/24GSP	51,85
				335/24GSP-ED	51,85,133
				335/7A	29
				335/B1	51,85
				335/B1-ED	51,85,133
				335/GF14	51,85
				335/GF14-ED	51,85
				335/H	86
				335/M10	85
				335/M10-ED	85
				335/M9	51,85
				335/M9-ED	51,85
				335/MPI	133
				335/P4 - P6	134
				335/PH1	133
				335/PR3S	51,85
				335/S23	86
				335/T...	49
				336/11	87
				336/22	87
				336/5	86
				337/1	86
				337/71 - 74	86
				338/3 - 5	87
				353/1 - 3	82
				353/12	83,119
				353/20	83,119
				353/21	83,119
				353/5	83,119
				353/7	80,118
				353/8	80
				353/9	80
				354/6	80,134
				354/W1	80

354/W2	80	550/1	153	602/53LD	66	900/5	115
355/11 - 15	83	550/1A	153	602/53R	66	900/6	115
370/...	79	560/1	153	602/53RD	66	900/HTO7	97
371/...	79			602/65	66		
		600/1	54	602/88L	66	C110/...	26
400/...	42-43	600/13	57	602/88R	66	C114/...	26
400/...ED	42-43	600/13S	61	605/...	62	C150/...	26
401/13 - 14	46	600/17	55	610/...	69	C162/0	26
401/13S - 14S	46	600/18	55	610/5	36,69	C165/3	26
401/17S - 18S	46	600/2	54	630/...	144		
401/204	45	600/22	57	631/...	145		
401/204S	45	600/22S	61			P600/1	54
401/204SD	45	600/29	56	700/2	81,118	P600/13	57
401/204SDT-ED	52,117	600/29S	60	700/2K	81	P600/17	55
401/2RL	45	600/30	56	700/3	81	P600/18	55
401/2RLT-ED	52,117	600/33	57	700/5	81	P600/2	54
401/4RL	45	600/33A	57	700/6	81,118	P600/22	57
401/4RLT-ED	52,117	600/33S	61	700/7	81	P600/29	56
401/C1 + C2	114	600/34	59	700/8	81	P600/30	56
401/C13 - 14	45	600/35	59	700/O2	81	P600/33	57
401/CI03	44	600/36	59	720/...	108-109	P600/33A	57
401/CK6	44	600/37	60			P600/4	57
401/FB1112	50	600/39	60	800/1 + 1A	112	P600/46L	59
401/FS	50	600/39L	60	800/2 + 2A	112	P600/51	56
401/GF...	47	600/39R	60	800/5	120	P600/51A	56
401/H3 - 7	50	600/4	57	800/51	120	P600/67A	55
401/H5 - 11	50	600/46L	59	800/51-25	120	P600/7	54
401/H5 - 33	44	600/51	56	800/84	120	P600/73	57
401/H6/H7	44	600/51A	56	801/A	116	P600/74	59
401/H6H7T-ED	52,117	600/51S	60	801/S	116	P600/74N	59
401/IU13 - 14	46	600/67	55	802/A	116	P600/75	57
401/IU17 - 18	46	600/67A	55	806/1 - 4	113	P600/79	58
401/K1	48	600/7	54	806/20 - 21	113	P600/86A	58
401/KGF...	48	600/73	57	808/21 - 23	132	P600/89	55
401/KO12	48,133	600/74	59	808/31 - 39	132	P600/90	55
401/L...	46	600/74N	59	808/391 - 392	132	P600/SET	63
401/L1-2T-ED	52,117	600/75	57	808/41 - 49	132		
401/L3-4T	52,117	600/76	56	808/491 - 498	132		
401/L5-6T	52,117	600/76N	56	810/SL...	124-125		
401/O3	48	600/79	58	811/SL1F - SL4F	123		
401/O4	48	600/79A	58	811/SL5F - SL6F	112		
401/RBA	48,133	600/86A	58	811/SL7T	112		
401/ST	51	600/86C	58	812/...	127		
401/T2 - 3	44	600/89	55	815/...	127		
401/U15 - 30	44	600/90	55	816/...	126		
405/23-CP8	10	600/99	58	817/...	126		
405/23W	10	600/99-1-4	58	820/...	130		
405/23-WHO	10	600/PEDO-SET	61	821/...	130		
405/2N	10	600/SET	63	823/...	130		
405/2NC-V	10	602/1	64	824/...	130		
405/CP10	11	602/10S	64	830/...	131		
405/CP11	11	602/10SD	64	831/...	131		
405/CP12	11	602/150	67	832/...	131		
405/CP15	11	602/150D	67	833/...	131		
405/PGF	11	602/150S	68	840/...	128		
405/PGFW	10	602/151	67	841/...	128		
405/W	11	602/151D	67	842/...	128		
405/WHO	11	602/151S	68	843/...	128		
		602/17	67	844/...	128		
500/...	140-143	602/17D	67	845/...	128		
510/...	139	602/18L	65	848/...	129		
511/...	139	602/18R	65	849/...	129		
512/...	139	602/23	67	851/...	129		
513/...	139	602/23D	67	852/...	129		
514/...	139	602/286	67			900/2	151
515/...	139	602/286D	67			900/2A	151
516/...	139	602/53L	66				