

14

Cardiovascular
Herz-Kreislauf
Cardiovascular
Cardiovasculaire

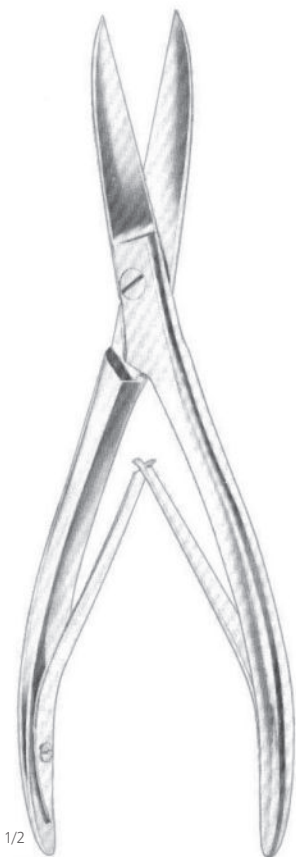



14-100-23
23 cm

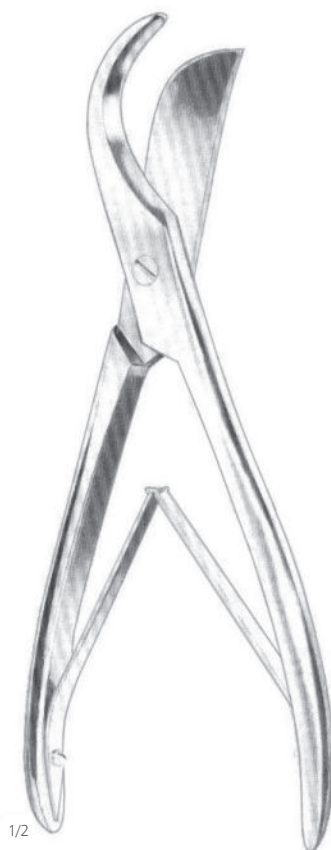

14-105-22
22 cm



Gluck
14-109-22
22 cm



1/3
 Sauerbruch
 14-121-26
 26 cm



1/3
 Giertz - Stille
 14-123-27
 27 cm

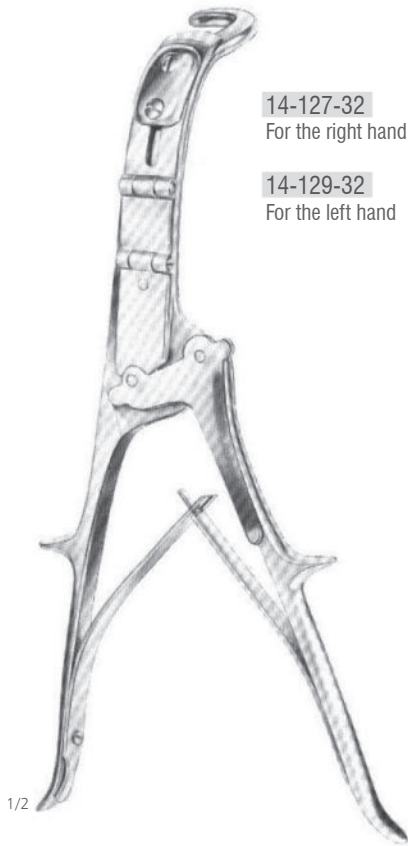

14-127-32
 For the right hand

14-129-32
 For the left hand

1/2
 Brunner
 14-127-32 - 14-129-32
 32 cm

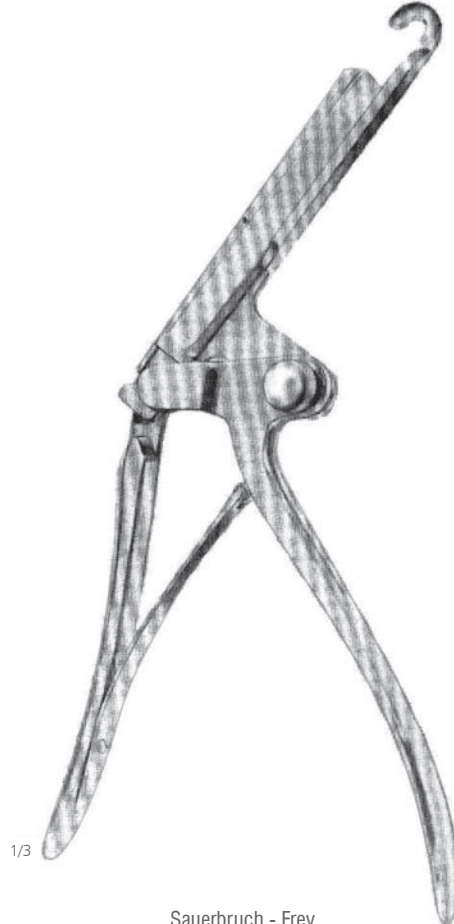

1/3
 Sauerbruch - Frey
 14-135-36
 36 cm

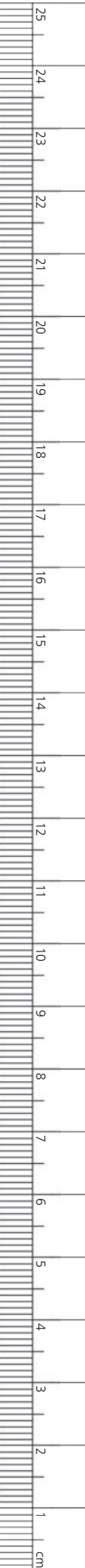



Bethune
 14-142-34
 34 cm



Lebsche
 14-141-24
 24.5 cm

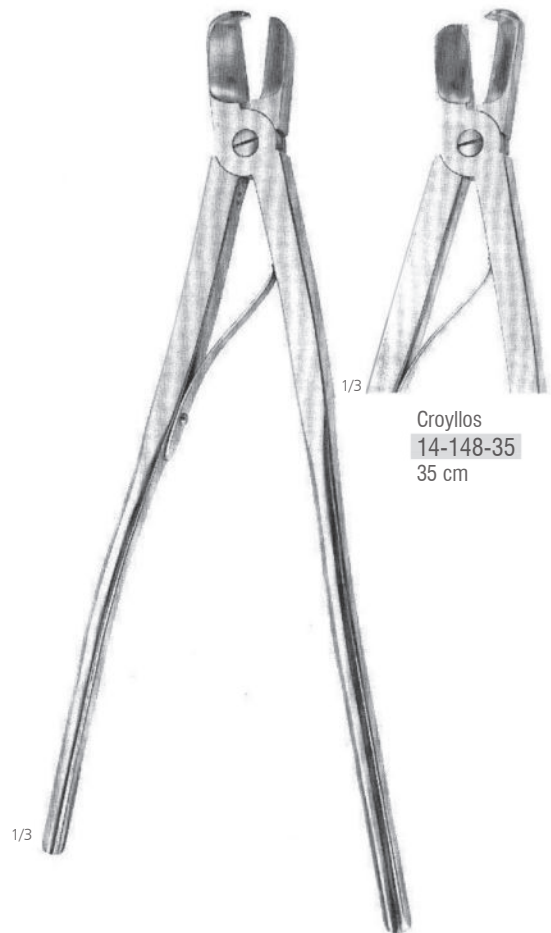

Croyllos
 14-146-35
 35 cm

Croyllos
 14-148-35
 35 cm

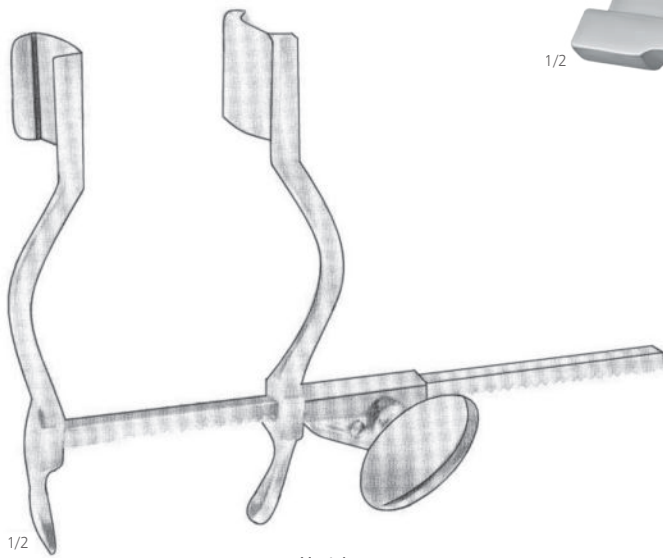

1/2

Hertzler
14-174-01
B=20 mm
H=25 mm
C=105 mm



1/2

Haight
14-170-90
B=30 mm
H=30 mm
C=90 mm

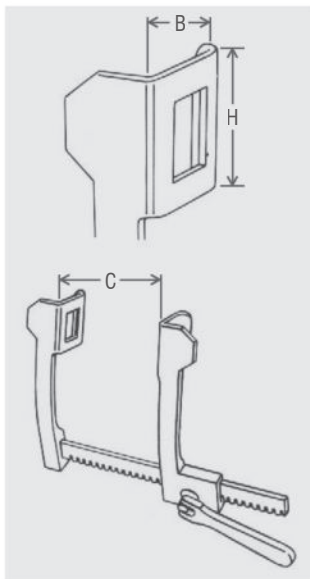

1/2

Hertzler
14-178-01
B=45 mm
H=45 mm
C=160 mm

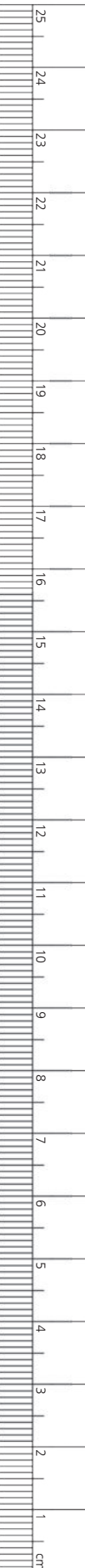

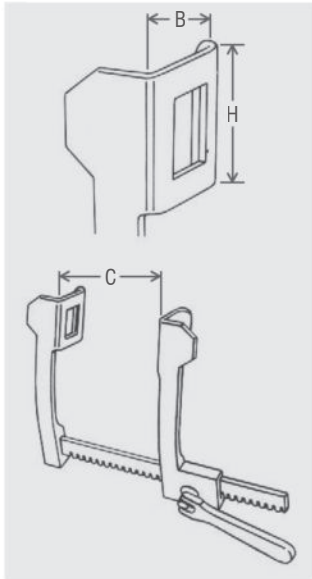

Finochietto - Baby
14-182-75
B=14 mm
H=15 mm
C=75 mm



Finochietto	14-186-01	14-186-02	14-186-03
B=30 mm	B=46 mm	B=80 mm	
H=45 mm	H=62 mm	H=65 mm	
C=150 mm	C=190 mm	C=190 mm	

Thoracic Retractor

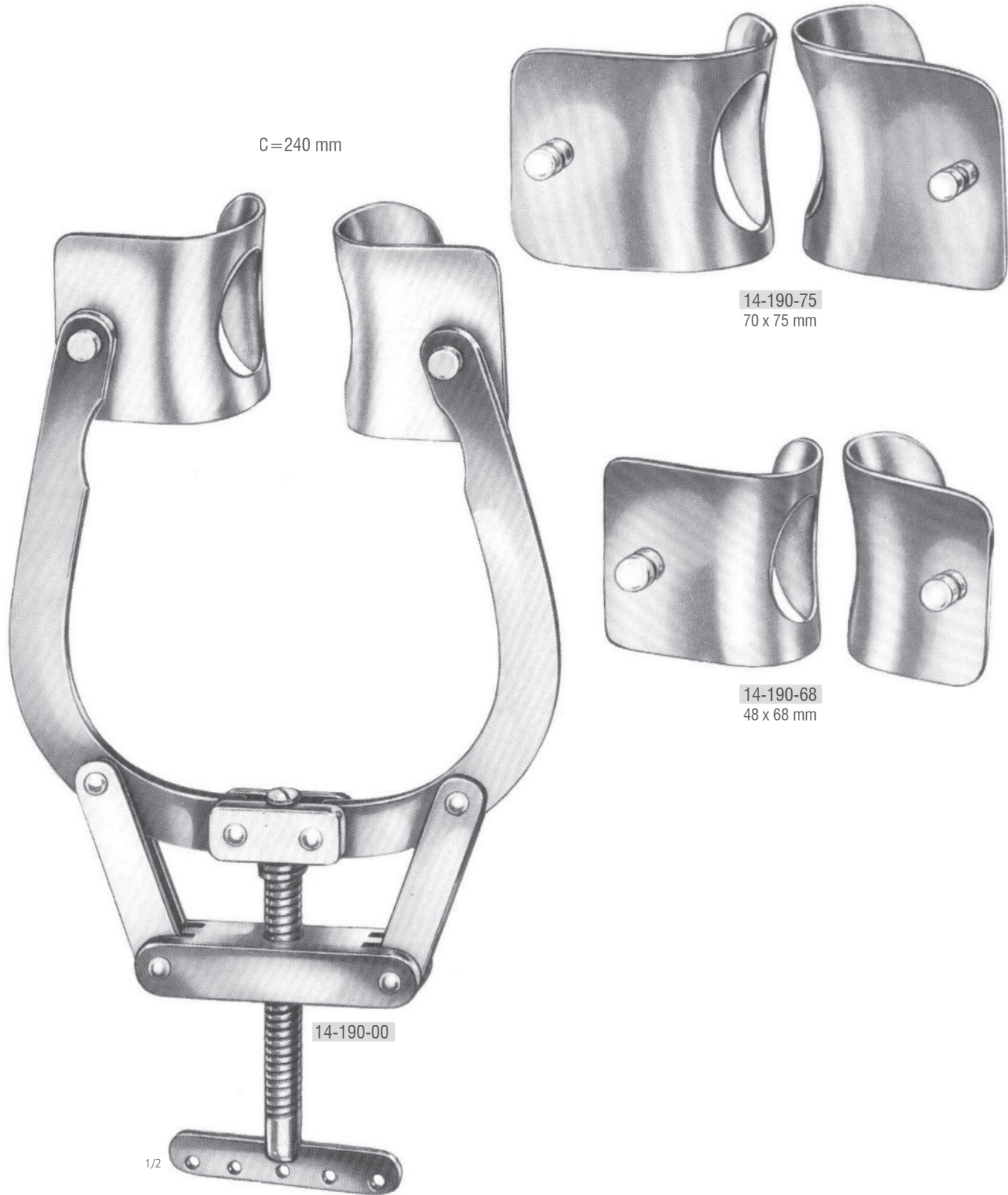

C=240 mm

14-190-75
70 x 75 mm

14-190-68
48 x 68 mm

14-190-00

1/2

Mercedes
14-190-00
Consisting:
1 x 14-190-01
2 x 14-190-68
2 x 14-190-75

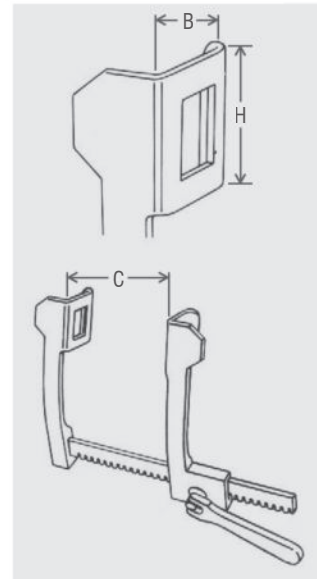

Martin - Chevalier
14-200-00
B=27 mm
H=100 mm
C=190 mm

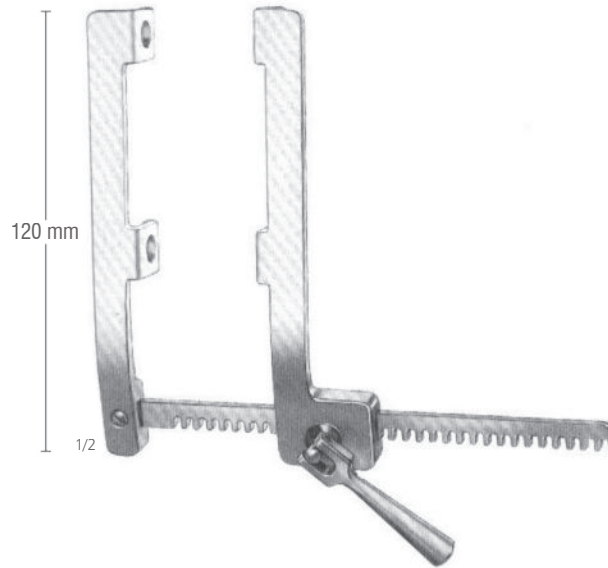
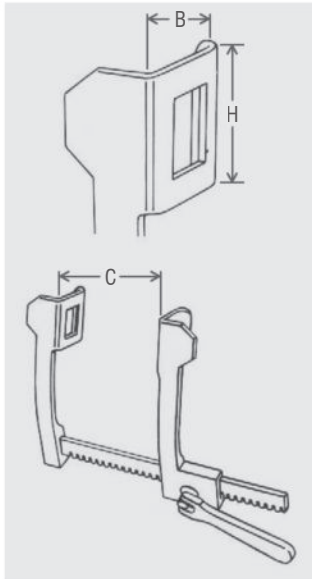

Finochietto (modif.)

14-204-01

B=14 mm

H=15 mm

C=120 mm

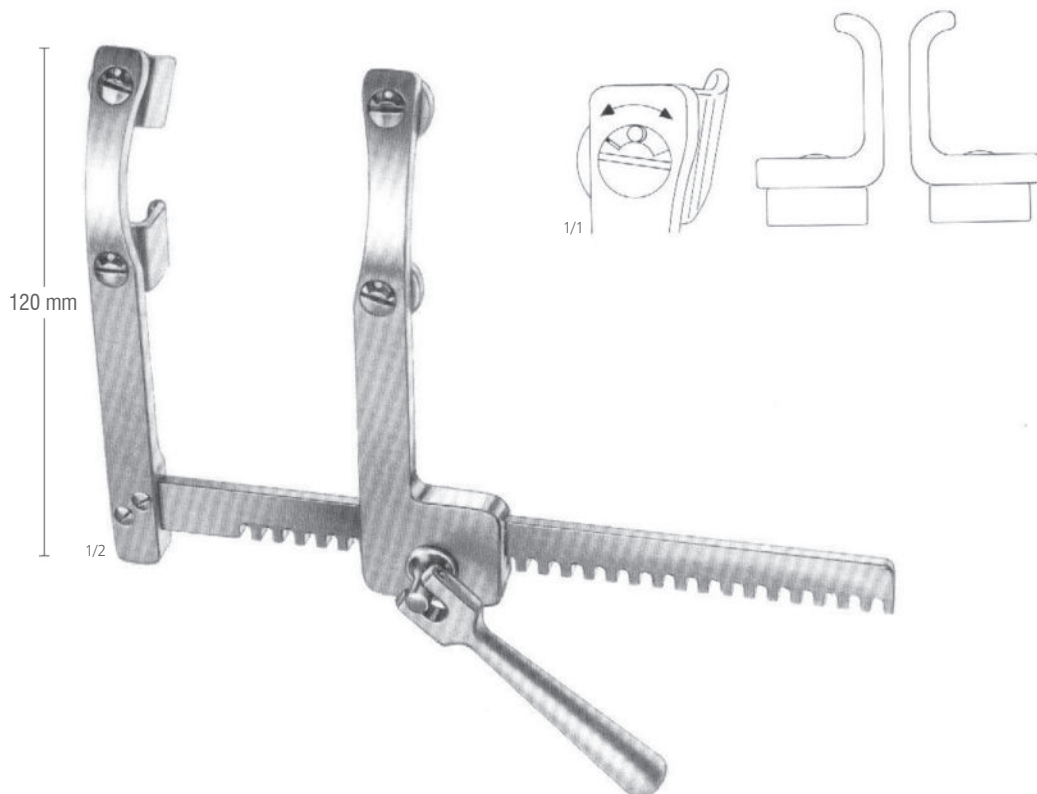

Morse - Favalaro

14-207-01

B=17 mm

H=22 mm

C=160 mm

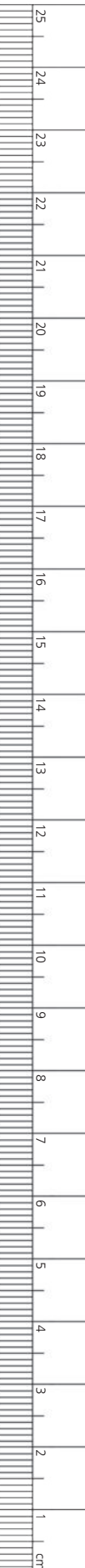



For babies

Finochietto - Infant
 14-210-01
 B=15 mm
 H=15 mm
 C=75 mm

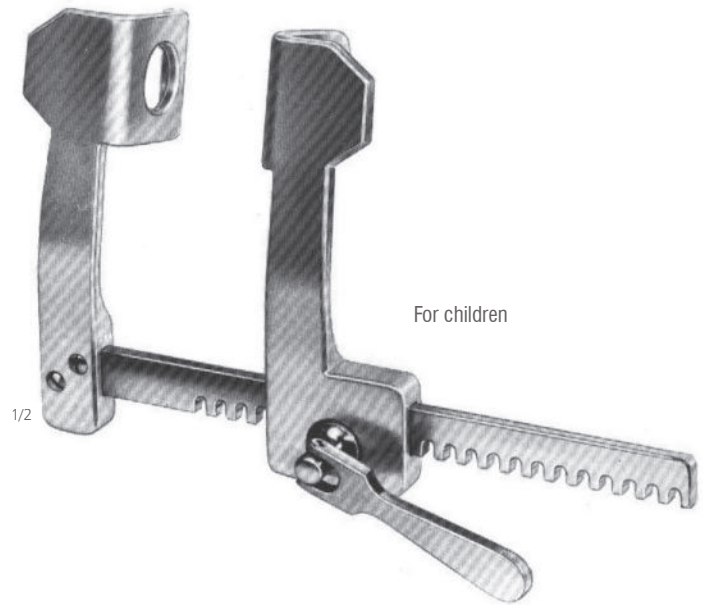

For children

Finochietto - Baby - Haight
 14-210-02
 B=31 mm
 H=31 mm
 C=100 mm

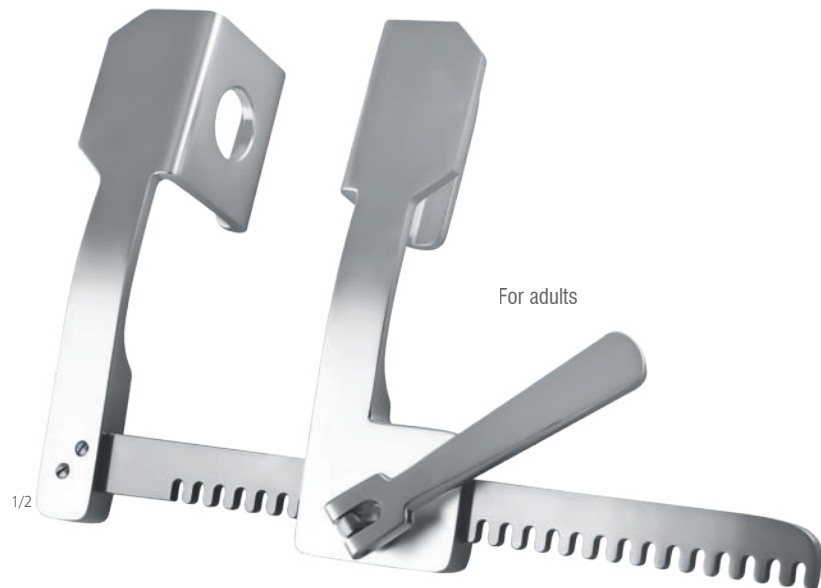
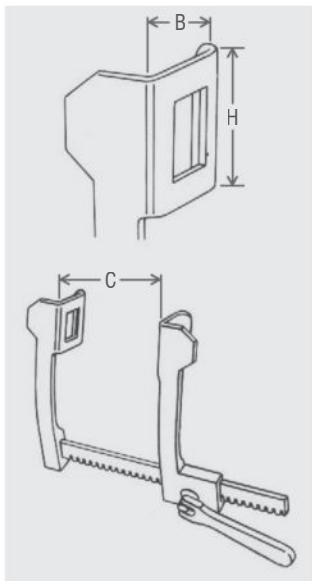

For adults

Finochietto
 14-210-03
 B=40 mm
 H=45 mm
 C=135 mm

14-210-04
 B=52 mm
 H=62 mm
 C=175 mm

14-210-05
 B=84 mm
 H=65 mm
 C=175 mm



For babies

Cooley
 14-214-01
 B=12 mm
 H=16 mm
 C=95 mm



For children

Cooley
 14-214-02
 B=15 mm
 H=30 mm
 C=140 mm

14-214-03
 B=21 mm
 H=44 mm
 C=150 mm

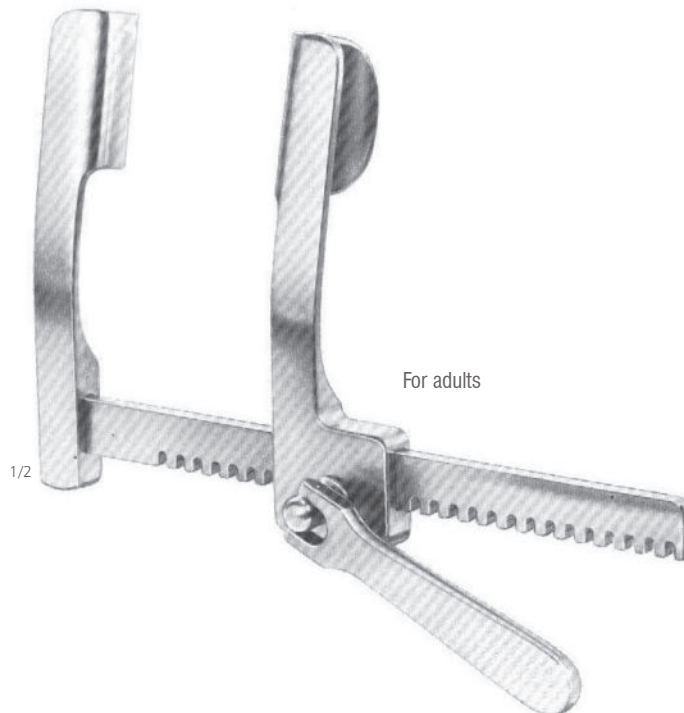
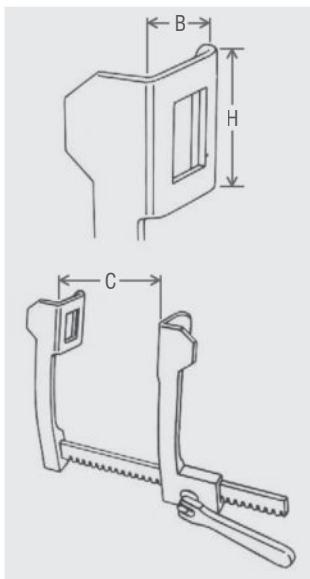

For adults

Cooley
 14-214-04
 B=35 mm
 H=50 mm
 C=200 mm

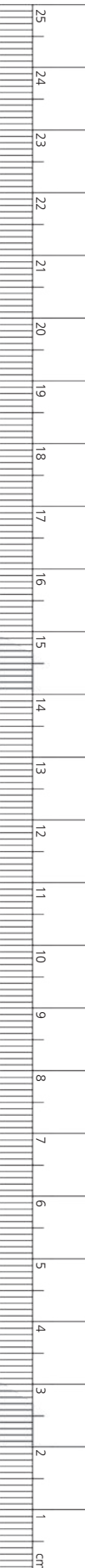



Castaneda
14-218-01
B=10.5 mm
H=32 mm
C=65 mm

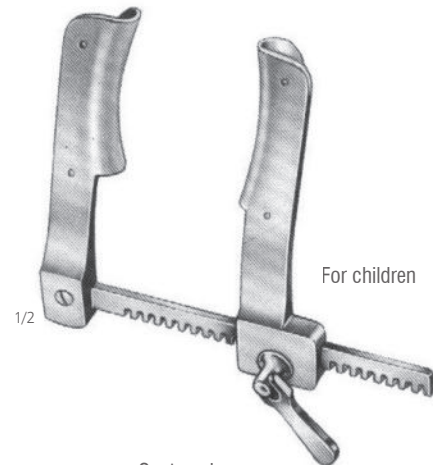

Castaneda
14-218-02
B=12 mm
H=45 mm
C=70 mm

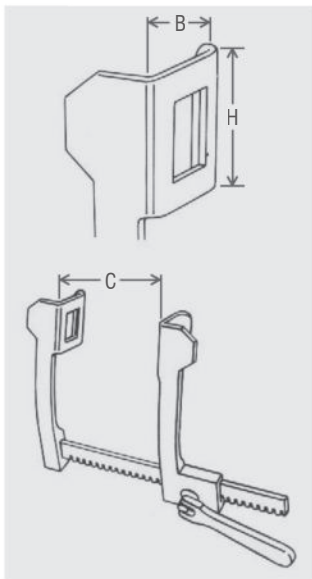

Castaneda
14-218-03
B=15 mm
H=60 mm
C=120 mm

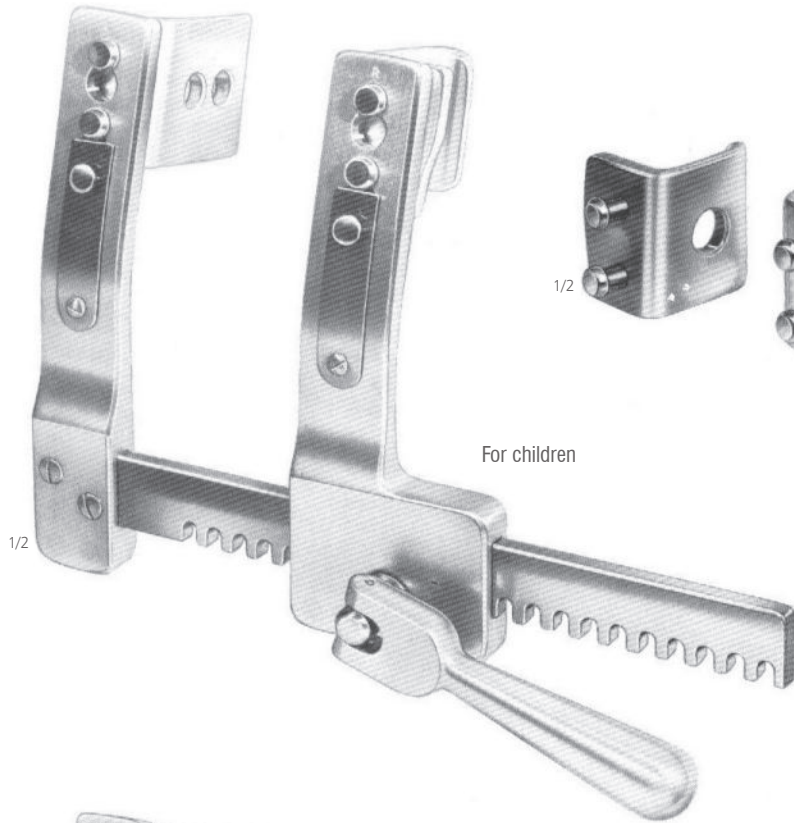

With 2 pairs of blades

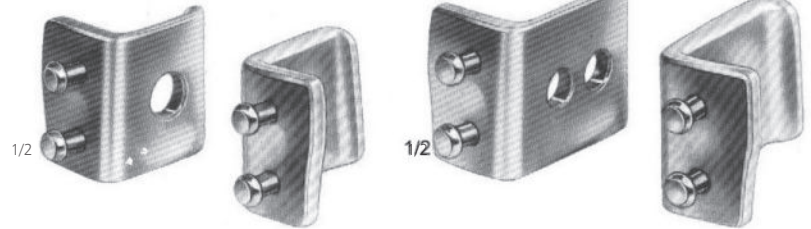

Burford

14-224-00

B=45 mm

H=42 mm

C=135 mm

B=34 mm

H=42 mm



With 2 pairs of blades

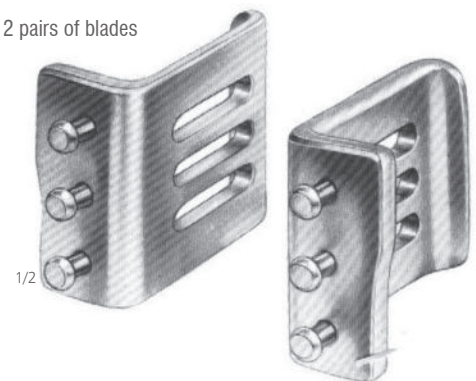

Burford

14-224-01

B=65 mm

H=62 mm

C=200 mm

B=47 mm

H=62 mm

14-224-02

B=65 mm

H=62 mm

C=250 mm

B=47 mm

H=62 mm

14-224-03

B=65 mm

H=62 mm

C=300 mm

B=47 mm

H=62 mm

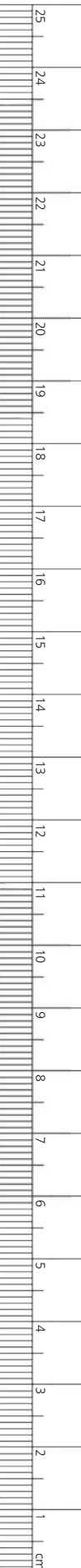

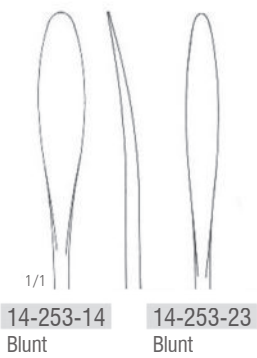

14-251-18 18.5 cm
14-251-21 21.5 cm



14-253-14 14.0 cm
14-253-23 23.5 cm

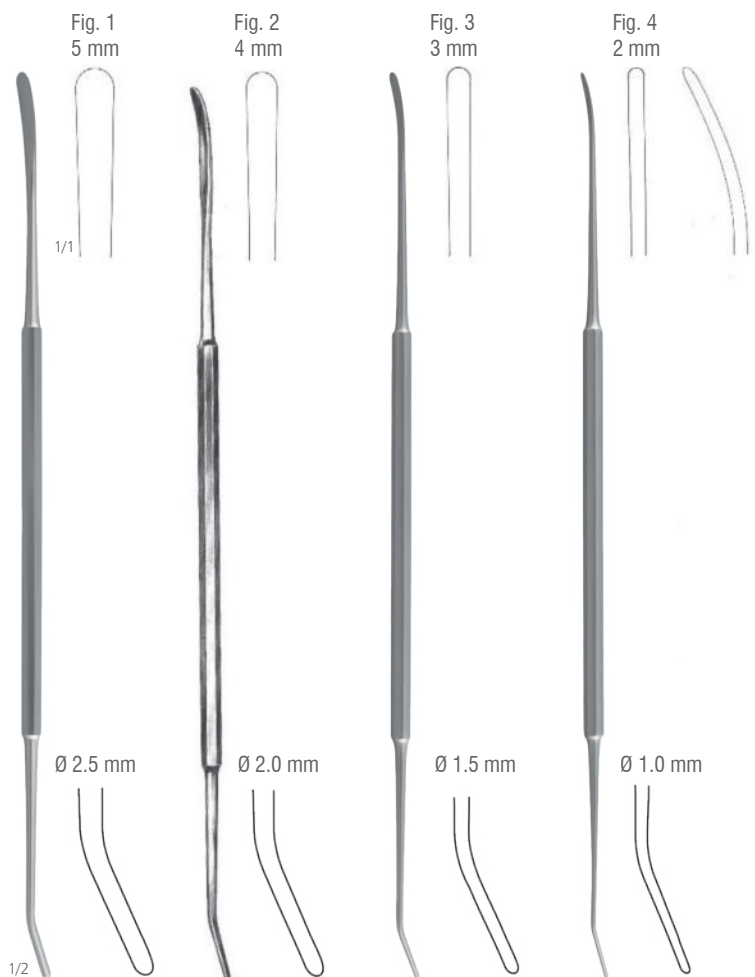

Robb
14-258-01
24 cm

Robb
14-258-02
24 cm

Robb
14-258-03
24 cm

Robb
14-258-04
24 cm



Cooley
14-260-05 - 14-260-50
13 cm

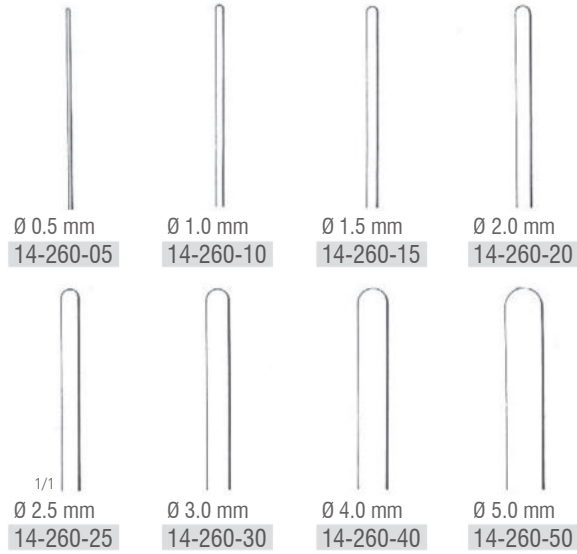

De Bakey
14-262-05 - 14-262-90 19 cm
14-264-05 - 14-264-90 35 cm

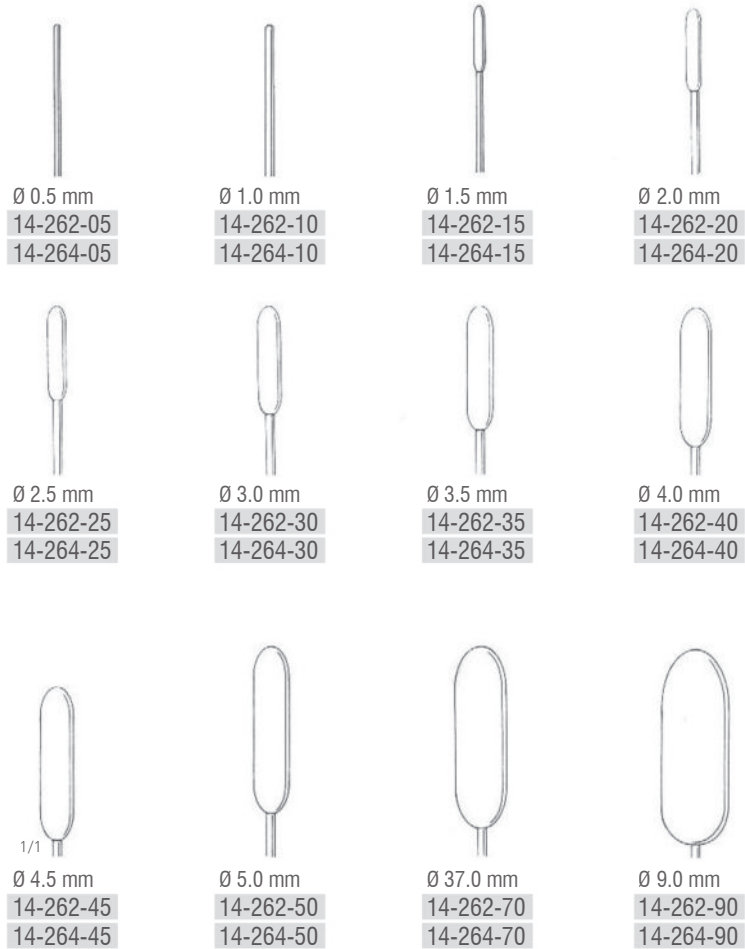

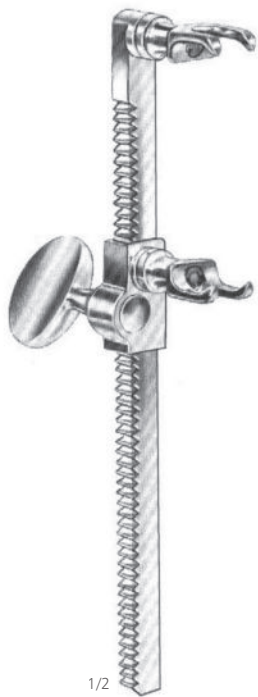

1/2
 Sellors
 14-270-19
 19 cm



1/2
 Bailey - Baby
 14-272-14
 14 cm



Short jaws

1/2
 Bailey
 14-274-16
 16 cm



Long jaws

Bailey - Gibbon
 14-276-16
 16 cm

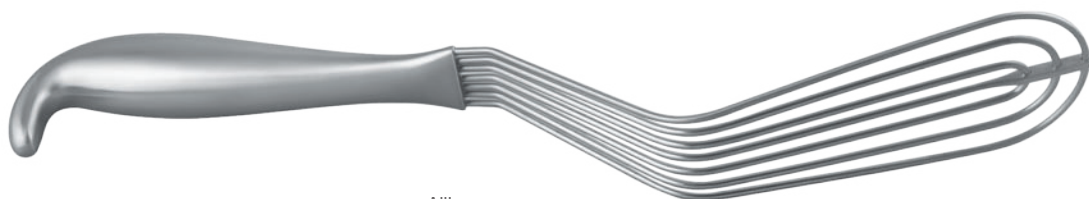

Allison
 14-281-30 30 cm
 14-281-32 32 cm

45 x 30 mm
Slightly serrated



Cooley - Struck
14-284-01
24 cm

45 x 35 mm
Slightly serrated



Cooley - Struck
14-284-02
24 cm



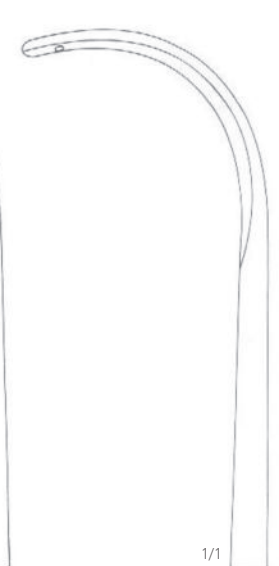

14-303-22

14-307-24

14-309-24



14-305-22



Price - Thomas
14-301-22
22 cm

Price - Thomas
14-303-22 - 14-305-22
22 cm

Semb
14-307-24 - 14-309-24
24 cm



Lavelace
 14-310-20 
 20 cm

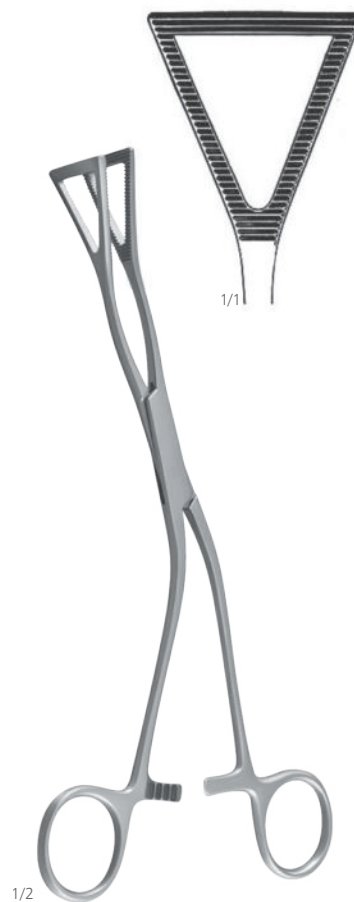

Lavelace
 14-311-20 
 20 cm

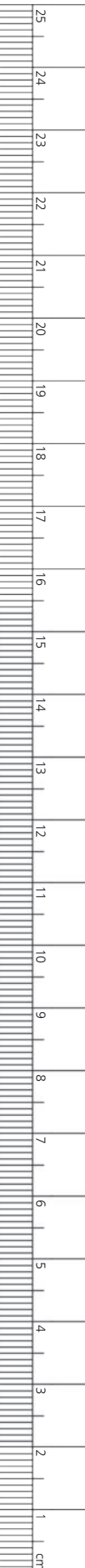



De Bakey - Satinsky
 14-331-07 
 7 cm



De Bakey - Carotis
 14-331-09 
 9 cm

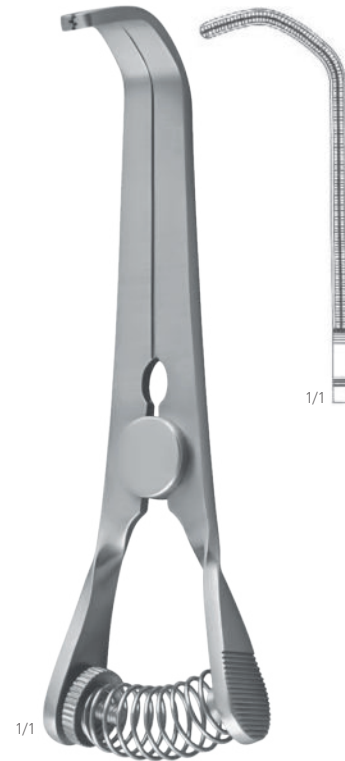

De Bakey - Carotis
 14-331-10 
 10 cm

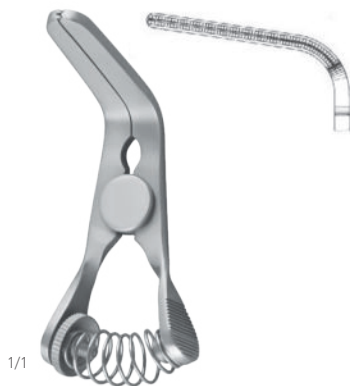

Gloves
 14-333-05 
 5 cm



Santulli
 14-335-07 
 7 cm



1/1
 Gregory - Soft
 14-337-09 - 14-337-11



1/1
 14-337-09
 9 cm



1/1
 14-337-11
 11 cm



1/1
 Gregory - Soft
 14-339-01 - 14-339-02
 11 cm



1/1
 14-339-01
 Left



1/1
 14-339-02
 Right



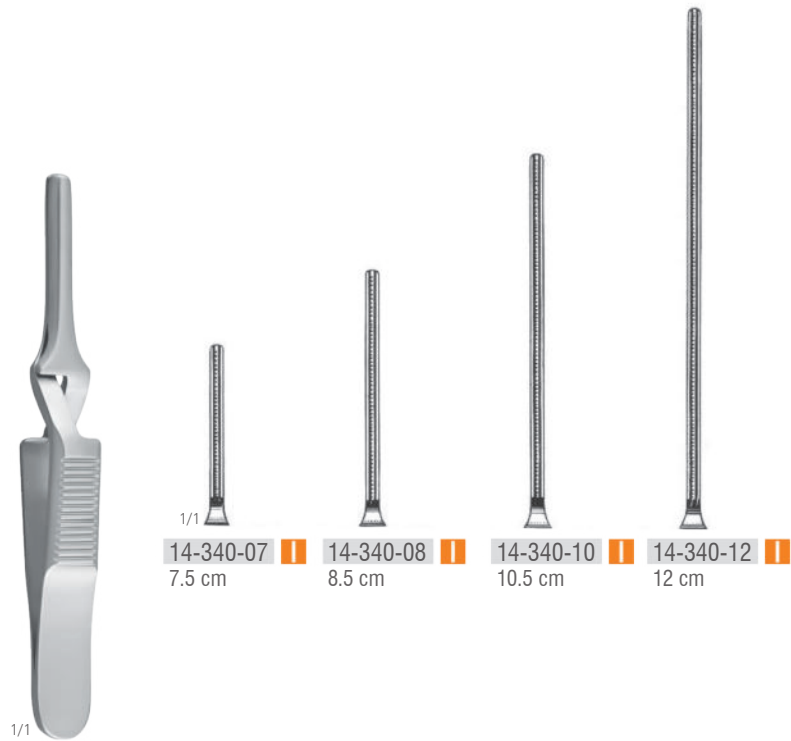

De Bakey
 14-340-07 - 14-340-12

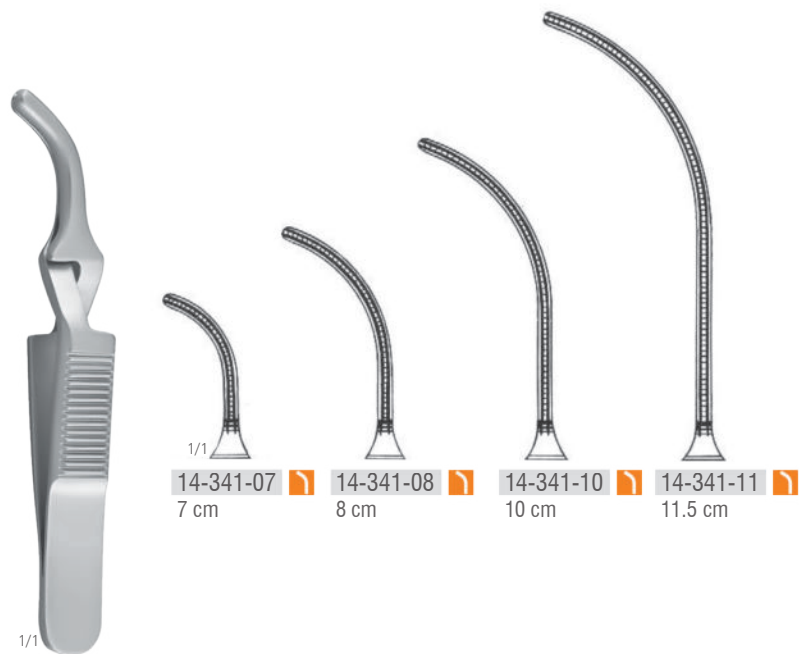

De Bakey
 14-341-07 - 14-341-11

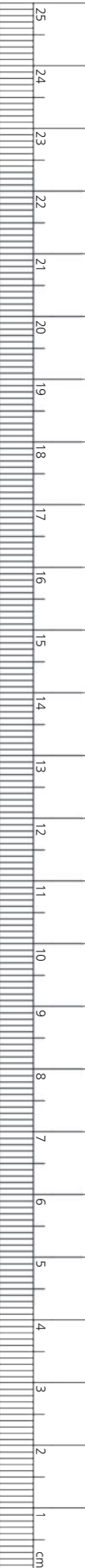
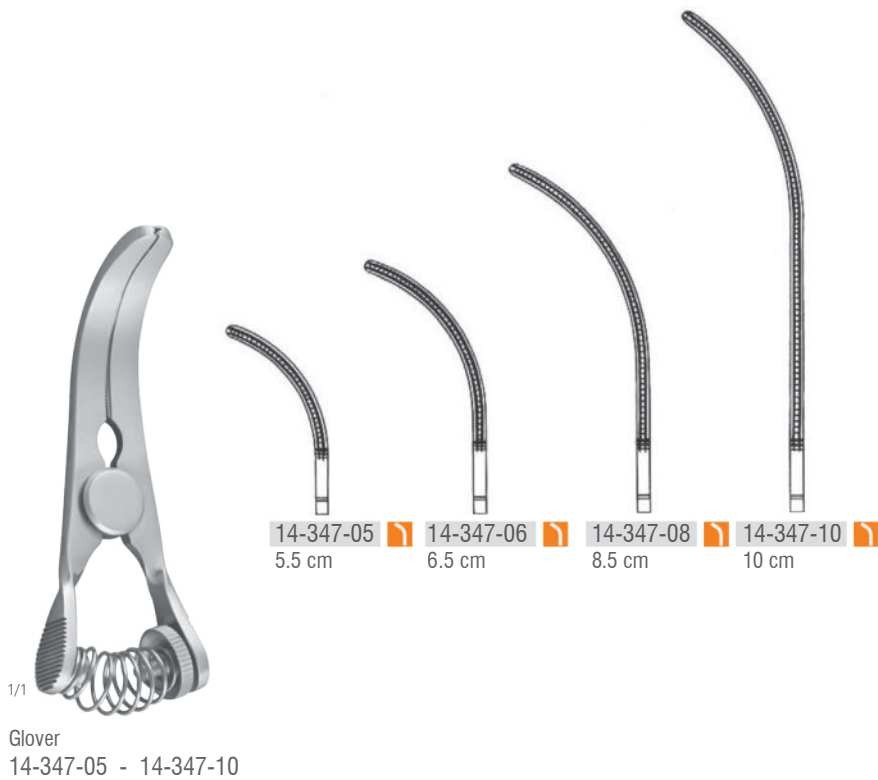
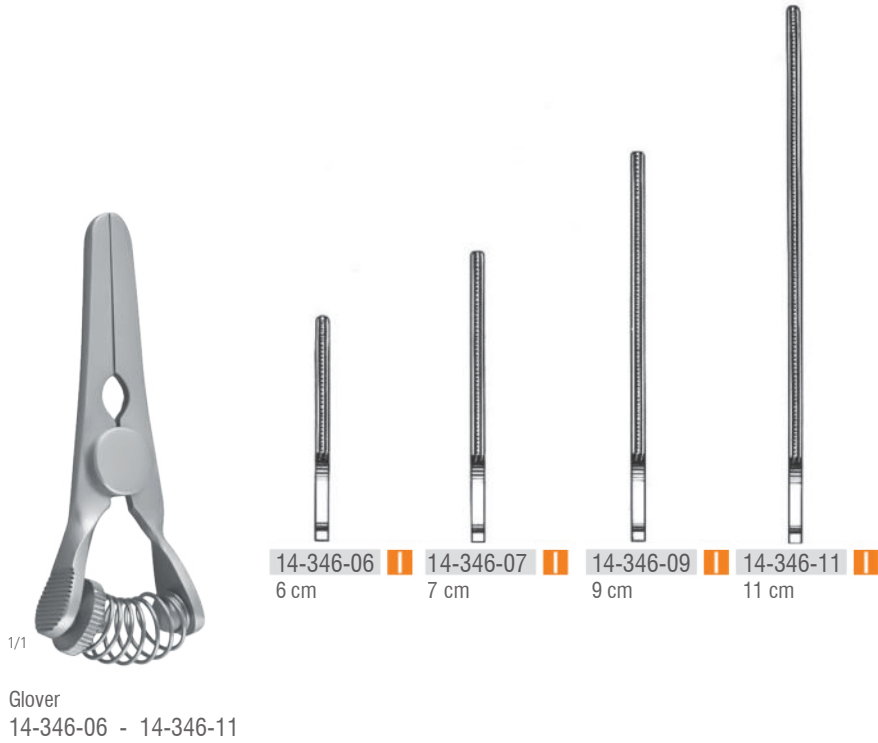



1/2

De Bakey - Rankin
 14-350-16 - 14-351-16
 16 cm



1/1

14-350-16  14-351-16 



1/2

De Bakey - Mosquito
 14-354-15 - 14-355-15
 15 cm



1/1

14-354-15  14-355-15 

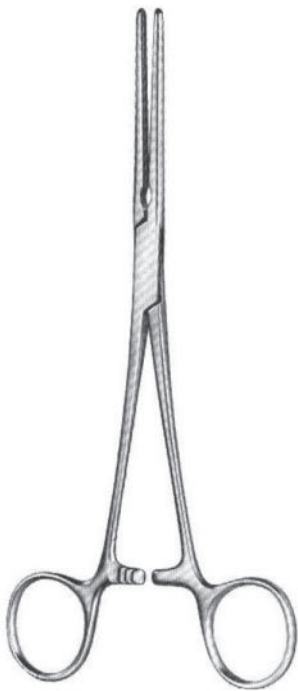

De Bakey - Pean
 14-360-12 - 14-360-20



De Bakey - Mosquito
 14-360-12
 12 cm



14-360-14
 14 cm



14-360-16
 16 cm



14-360-18
 18 cm



14-360-20
 20 cm



De Bakey - Pean
 14-361-12 - 14-361-20



De Bakey - Mosquito
 14-361-12
 12 cm



14-361-14
 14 cm



14-361-16
 16 cm



14-361-18
 18 cm

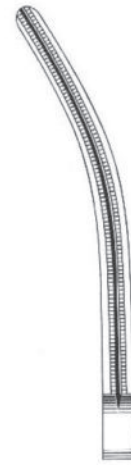

14-361-20
 20 cm



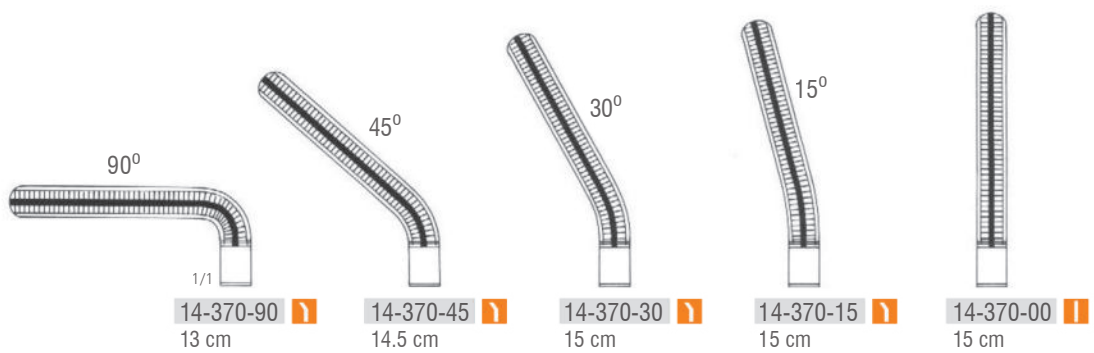



Dardik
 14-370-00 - 14-341-90



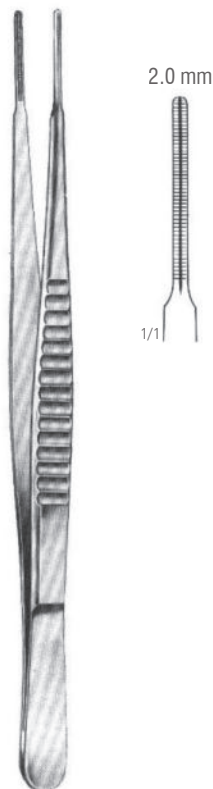

See Pages 06-30 & 06-31

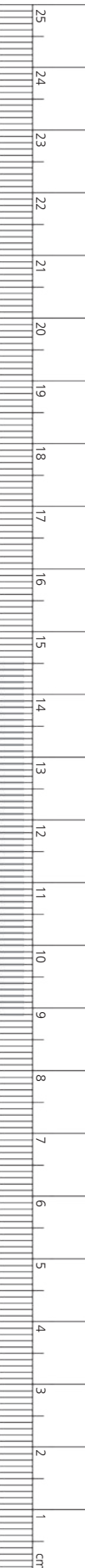

- Cooley
- 14-390-16 16 cm 
 - 14-390-20 20 cm 

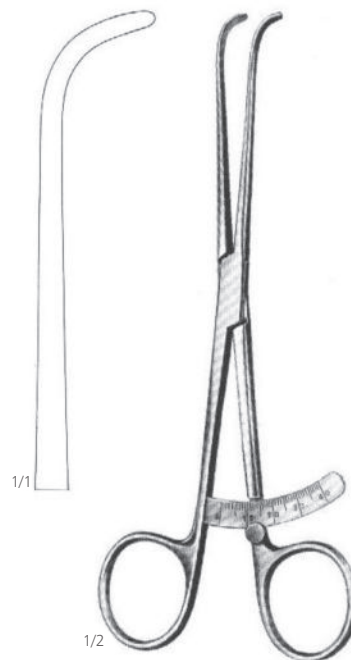
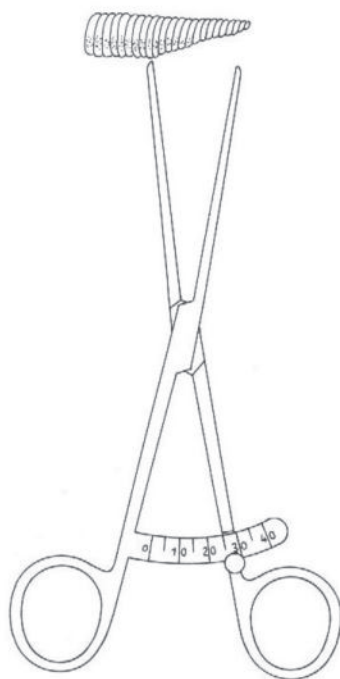



14-395-18 
18 cm



Ochner
 14-401-23 
 23.5 cm



Dietrich
 14-405-21 
 21 cm

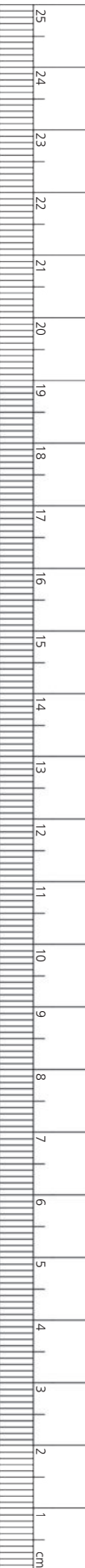



Dale
 14-410-18 
 18.5 cm

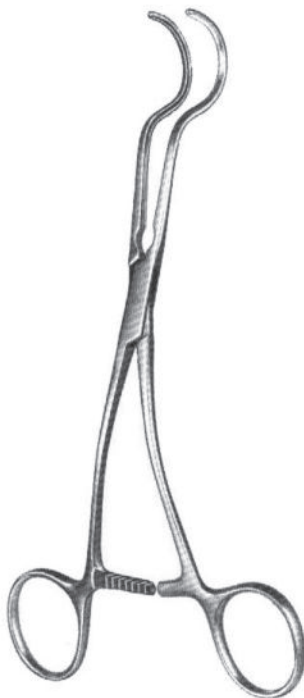

Dale
 14-411-01 - 14-411-03



1/1
 14-411-01 
 17 cm



14-411-02 
 17.5 cm

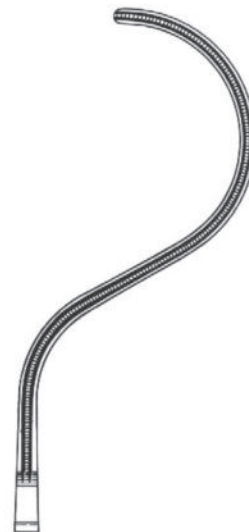

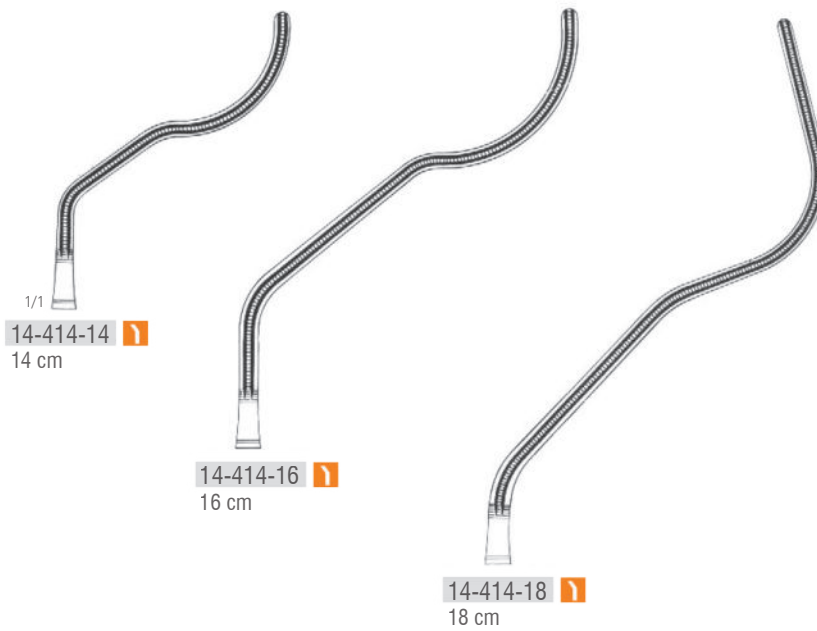

14-411-03 
 18.5 cm

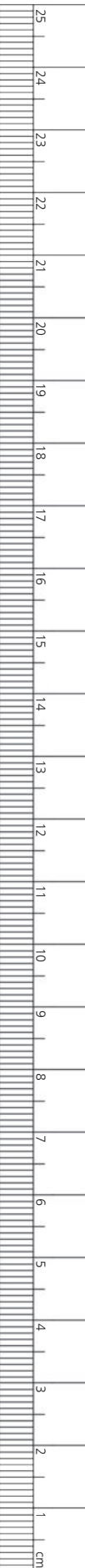

Gregory
 14-414-14 - 14-414-18

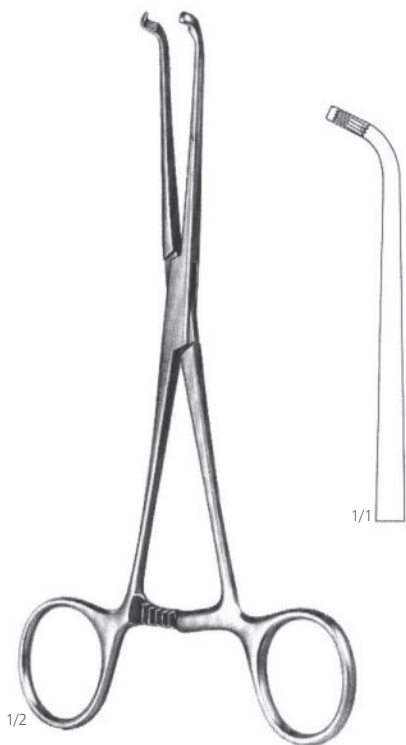



Javid
14-417-18 
18 cm



Javid
14-417-19 
19 cm



Coley

14-419-24	16 cm	24 Charr. / Fr.	
14-419-26	16 cm	26 Charr. / Fr.	
14-419-28	20 cm	28 Charr. / Fr.	
14-419-30	20 cm	30 Charr. / Fr.	
14-419-32	20 cm	32 Charr. / Fr.	
14-419-36	20 cm	36 Charr. / Fr.	

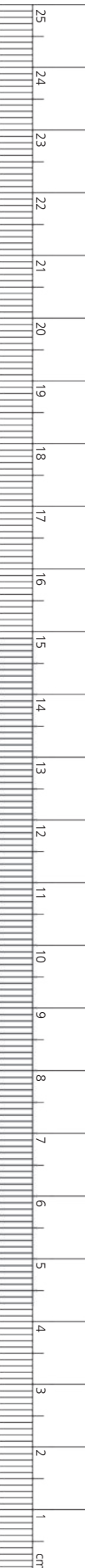





Martin
 14-420-16 
 16 cm

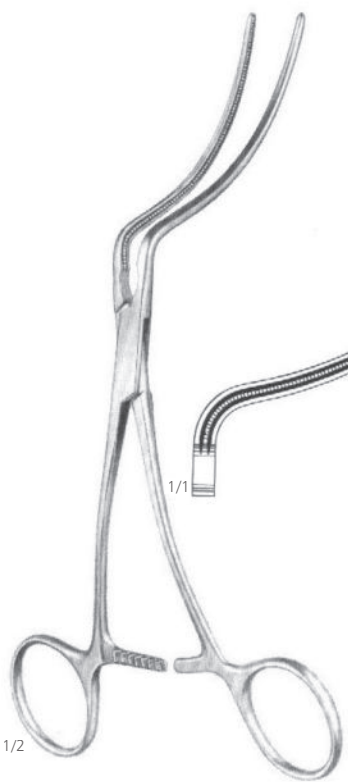

Martin
 14-420-17 
 17 cm



Martin
 14-420-18 
 18 cm



Martin
 14-420-20 
 20 cm

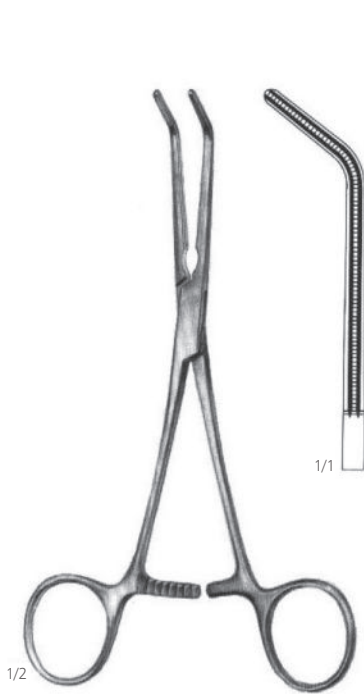
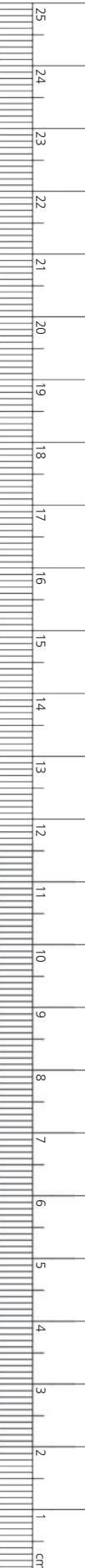

Husfeldt
 14-423-17 
 17.5 cm

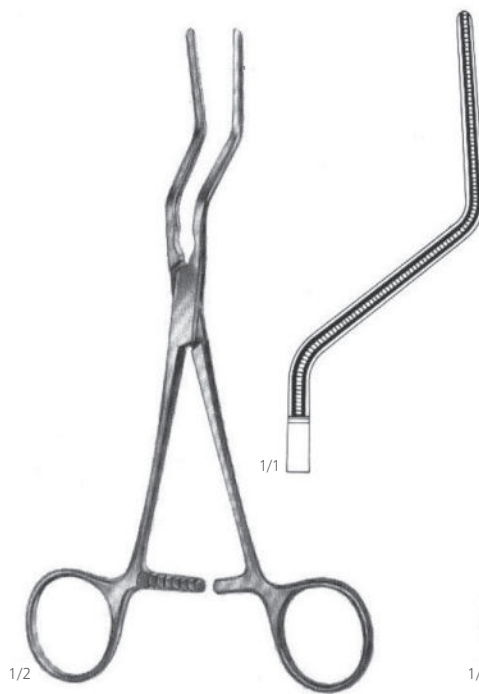

Husfeldt
 14-425-18 
 18 cm

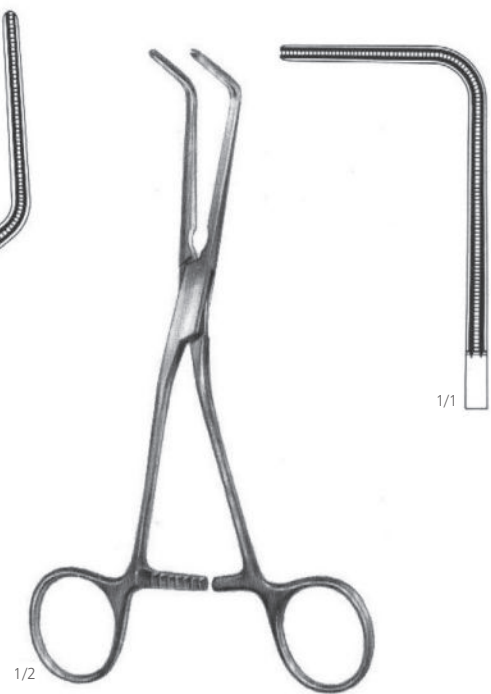

Husfeldt
 14-427-17 
 17 cm



1/1
 14-430-21 II
 21 cm

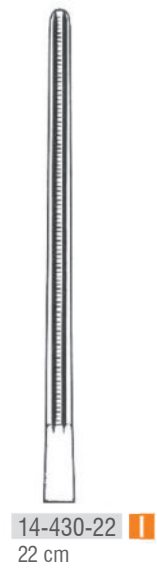

14-430-22 II
 22 cm

1/2
 Potts
 14-430-21 - 14-430-22



1/1
 14-431-21 I
 21 cm



14-431-22 I
 22 cm

1/2
 Potts
 14-431-21 - 14-431-22



1/1
 14-433-21 I
 21 cm



14-433-22 I
 22 cm

1/2
 Potts
 14-433-21 - 14-433-22

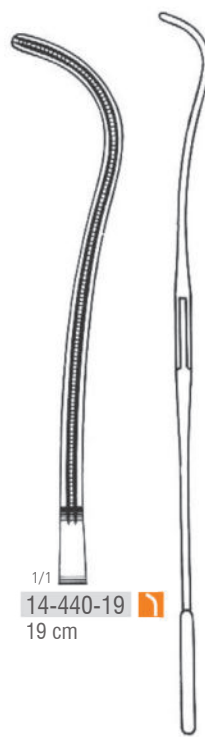
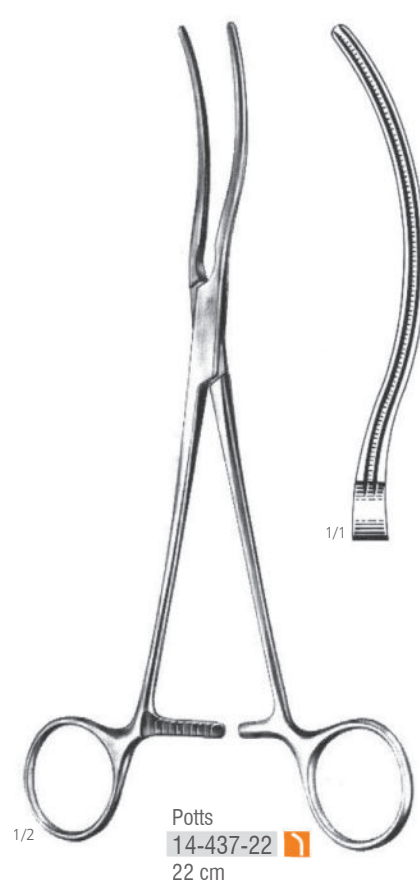
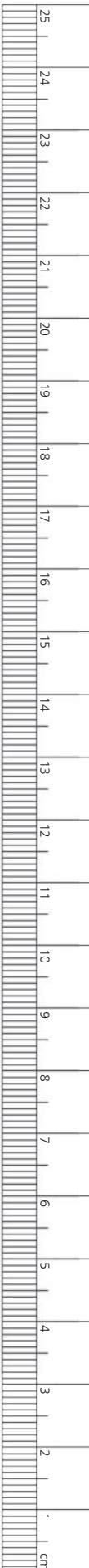

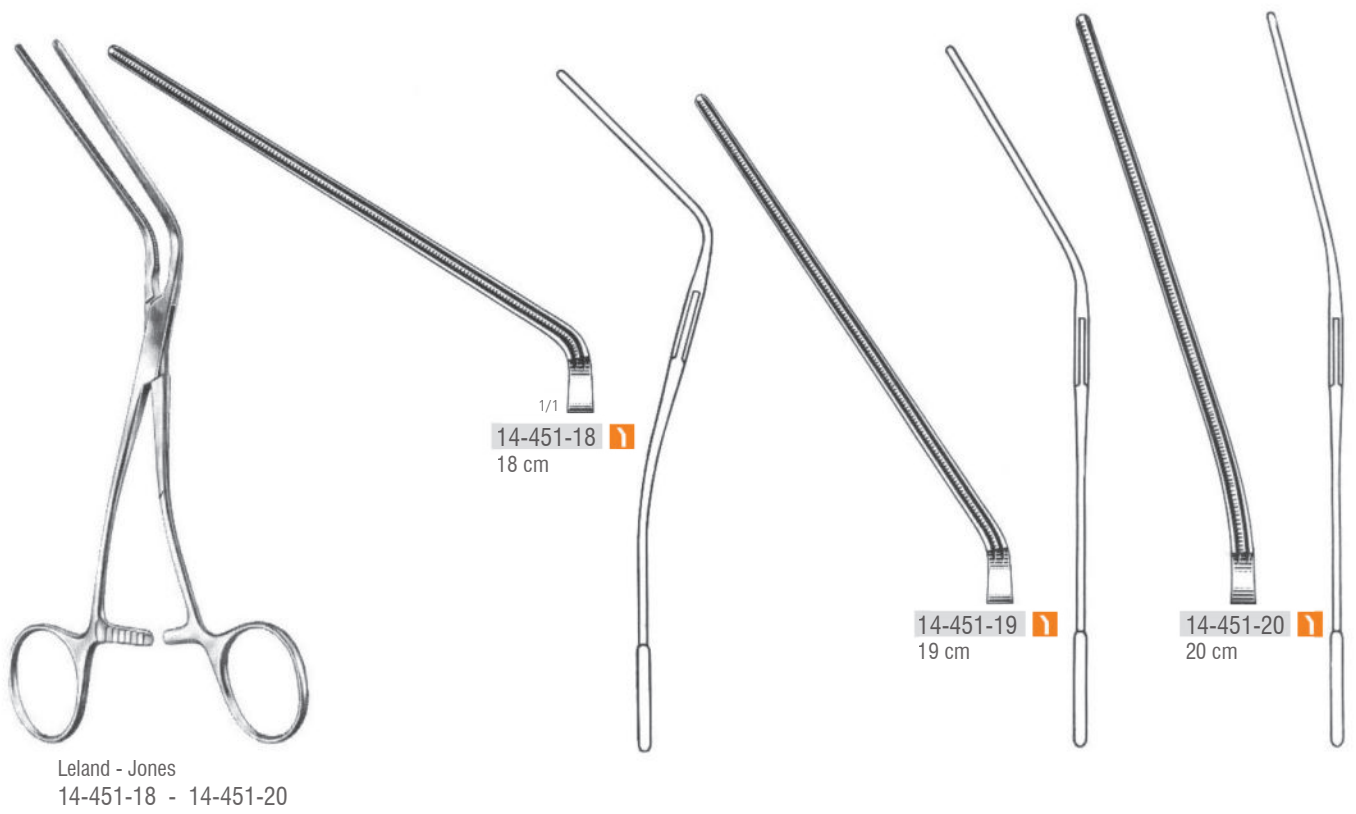



Bainbridge
 14-454-15 - 14-454-18

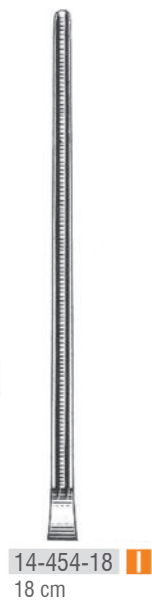
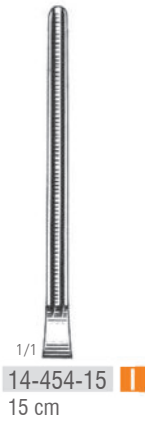

Bainbridge
 14-455-15 - 14-455-18



De Bakey
 14-456-20
 20 cm

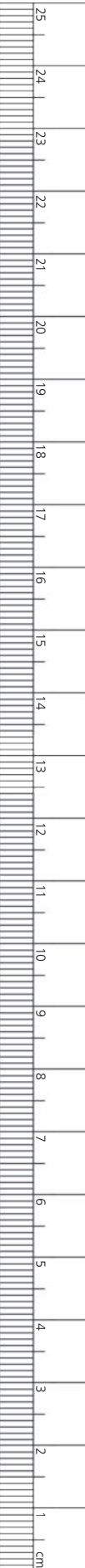
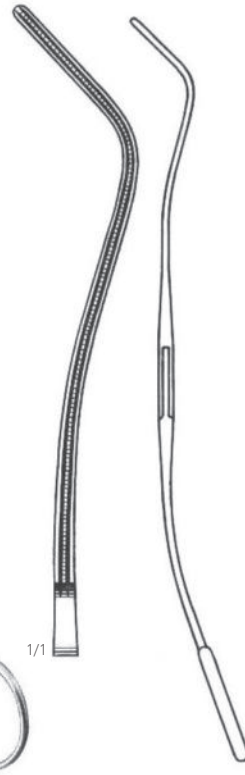



1/1
 14-461-26 1/1
 26 cm

14-461-27 1/1
 27 cm

14-461-31 1/1
 31 cm

14-461-33 1/1
 33 cm

De Bakey
 14-461-26 - 14-461-33



De Bakey
 14-465-28 
 28 cm

De Bakey
 14-467-30 
 30 cm



De Bakey
 14-470-27 
 27 cm

De Bakey
 14-471-24 
 24 cm

De Bakey
 14-473-24 
 24 cm



1/2

De Bakey
 14-481-26 
 26 cm



1/2

De Bakey
 14-481-26 
 26 cm

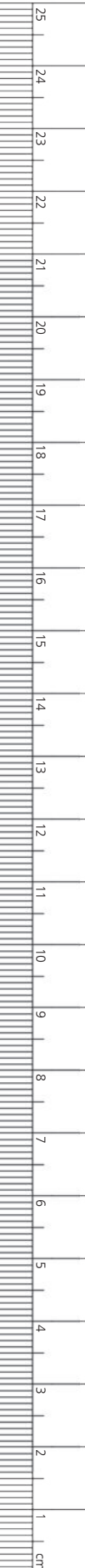



Weber
14-485-01 
26 cm



Weber
14-485-02 
26 cm

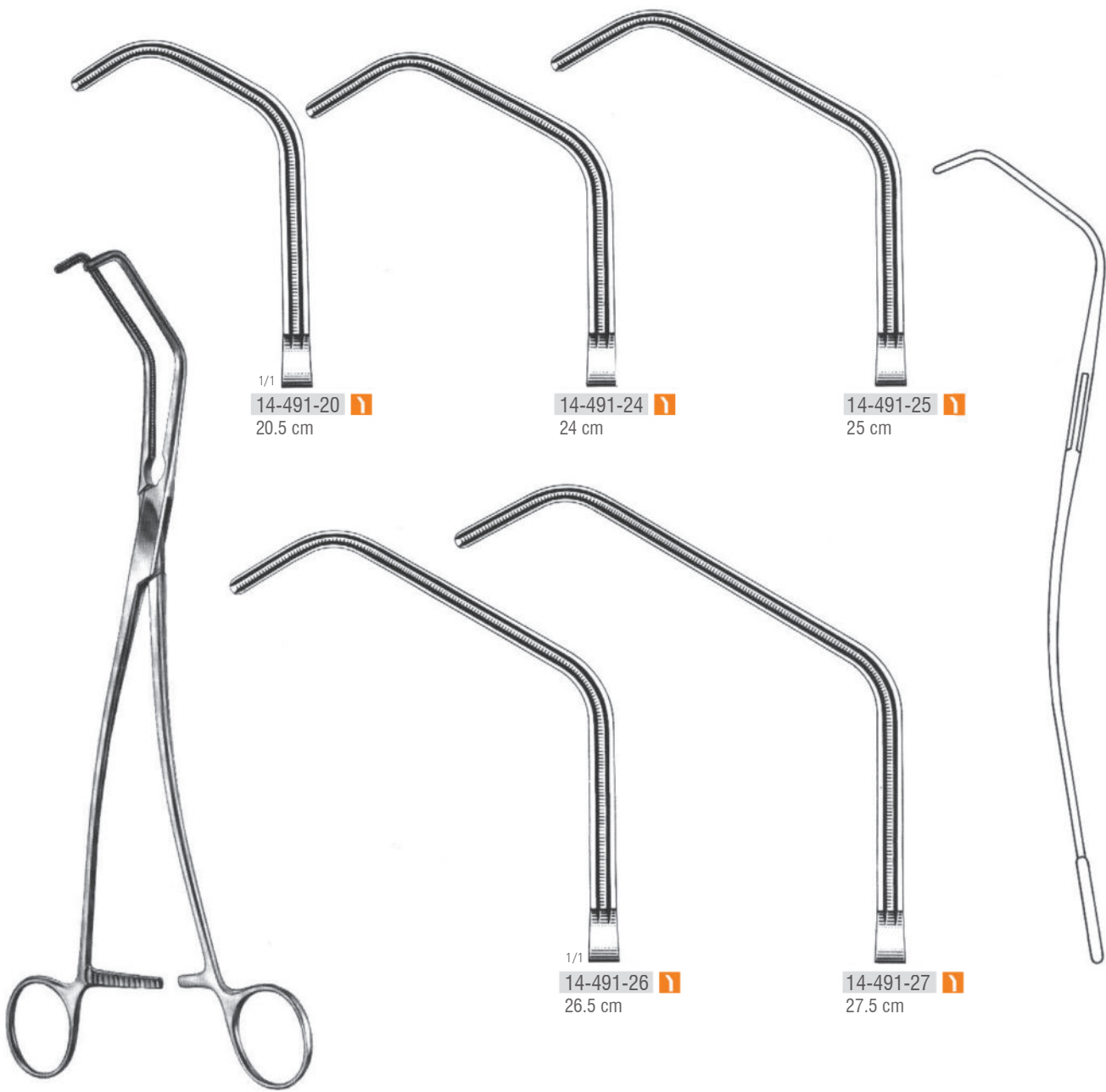

1/1
 14-491-20 20.5 cm

1/1
 14-491-24 24 cm

1/1
 14-491-25 25 cm

1/1
 14-491-26 26.5 cm

1/1
 14-491-27 27.5 cm

Satinsky
 14-491-20 - 14-491-27





Potts
 14-499-21 - 14-494-31



1/1
 14-494-21 
 21.5 cm



14-494-23 
 23 cm



14-494-27 
 27 cm



14-494-31 
 31 cm



Potts
 14-495-21 - 14-495-31



1/2
 14-495-21 
 21.5 cm



14-495-23 
 23 cm



14-495-27 
 27 cm



14-495-31 
 31 cm



De Bakey
 14-500-18 - 14-500-27

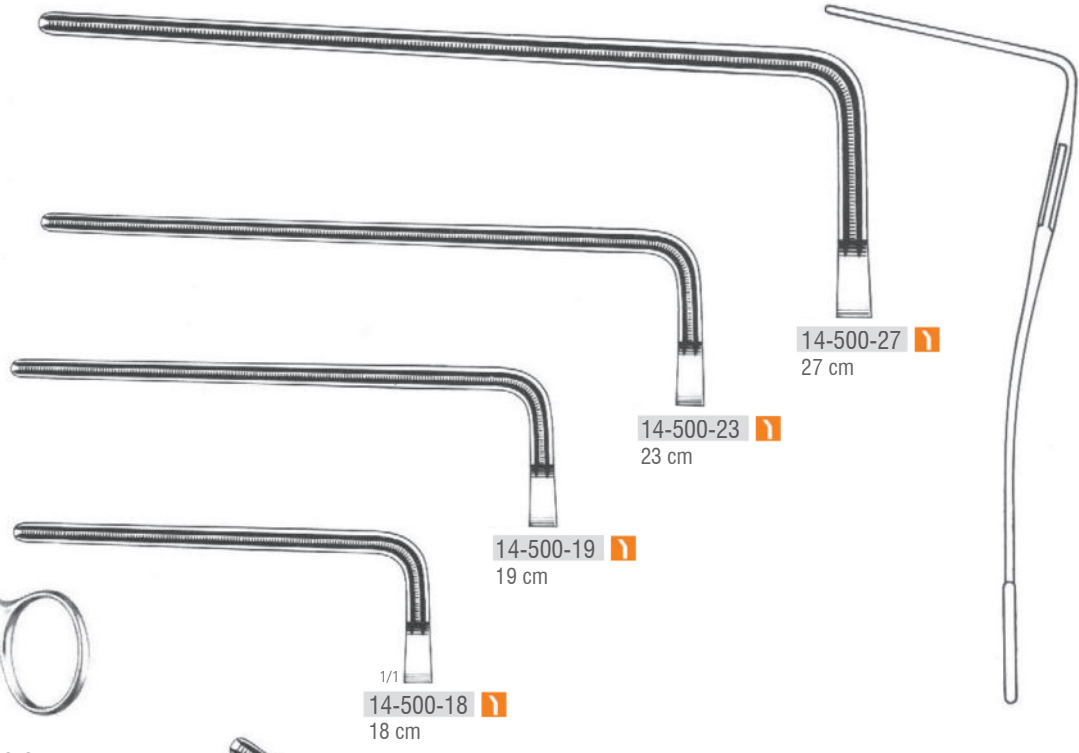

De Bakey
 14-501-20 - 14-501-29

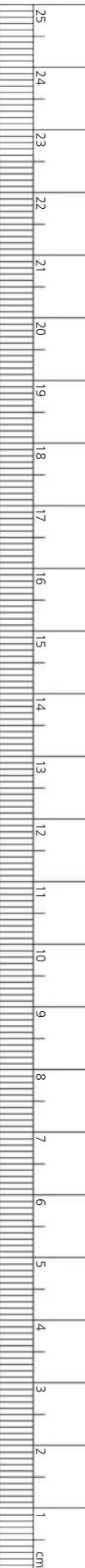
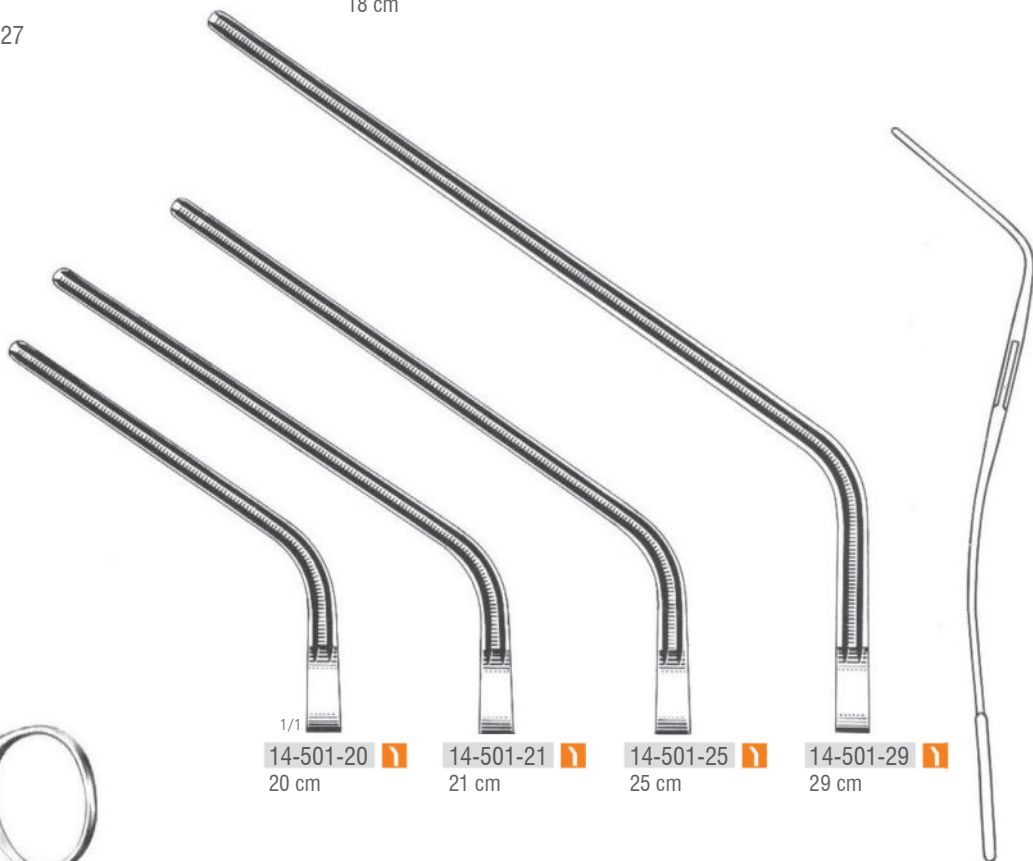



De Bakey - Bahnson
14-505-23 - 14-505-25

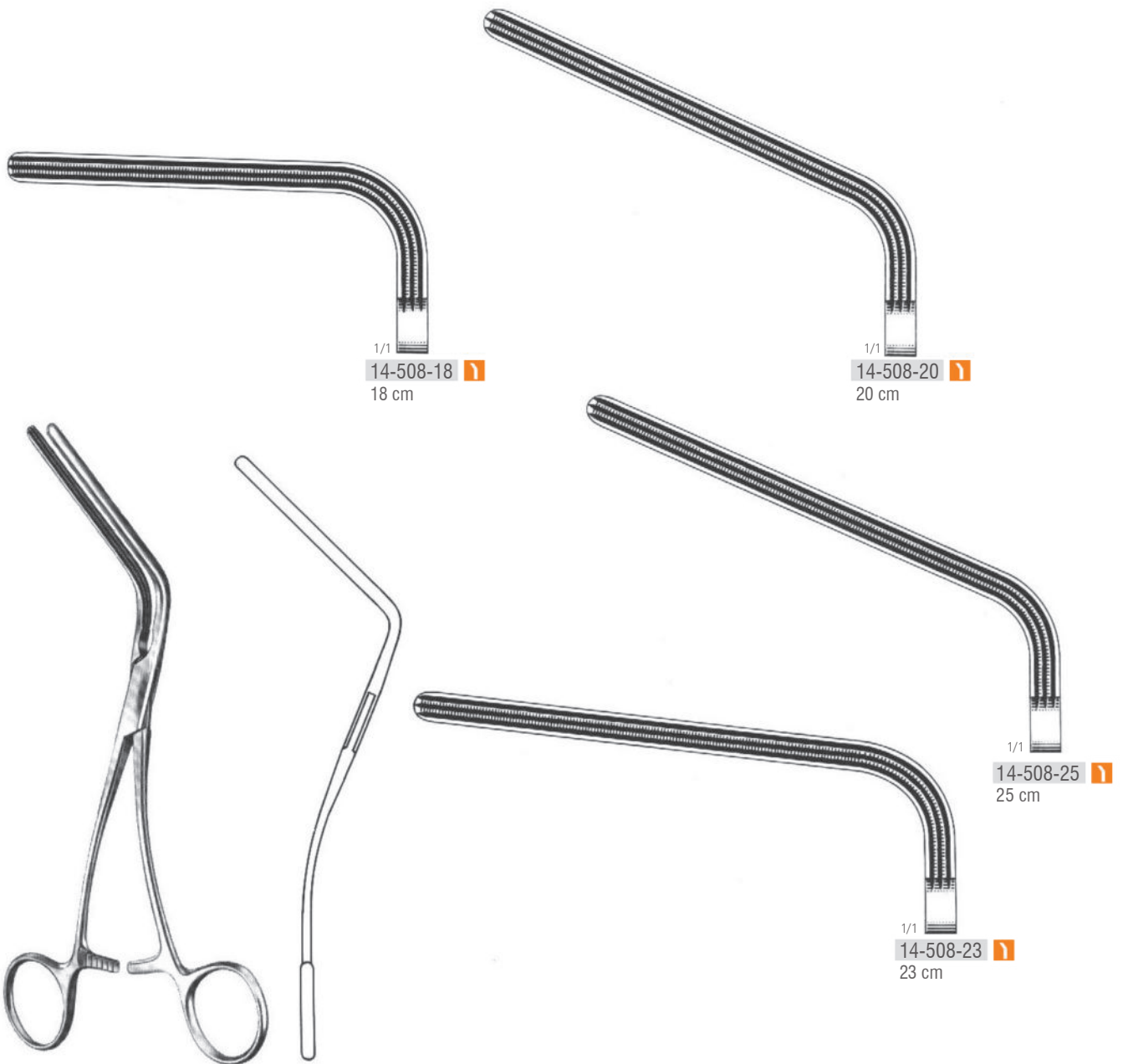

Morris - De Bakey
 14-508-18 - 14-508-25

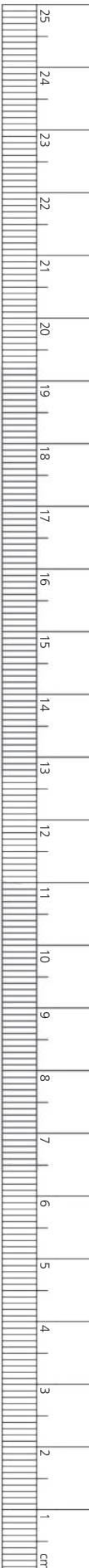



1/2

Lambert - Kay
 14-512-01 - 14-512-02
 21 cm



1/1

14-512-01



14-512-02

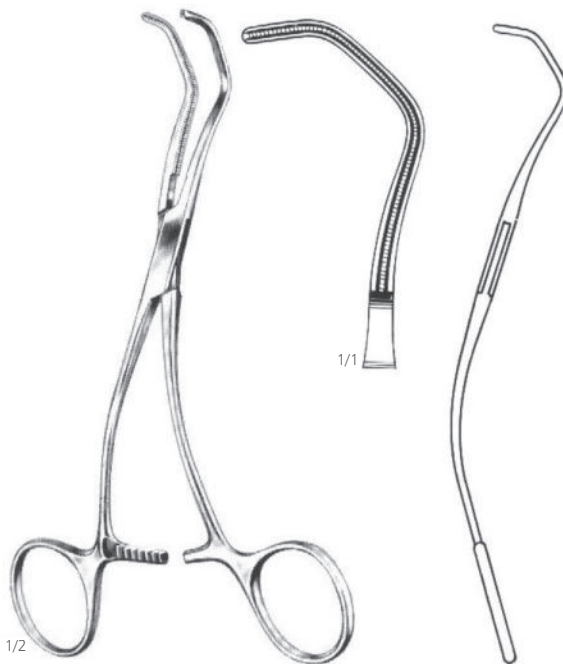
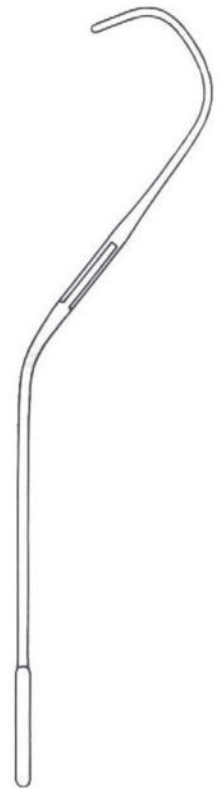

1/2

De Bakey
 14-516-17
 17 cm

1/1



Harken
 14-530-01 - 14-530-04
 24 cm

1/1
 14-530-01

1/1
 14-530-02

1/1
 14-530-03

1/1
 14-530-04

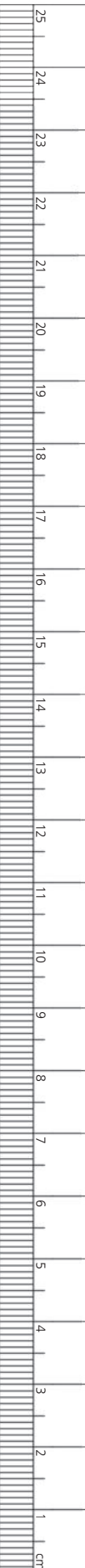



Lees
 14-533-23 - 14-533-25

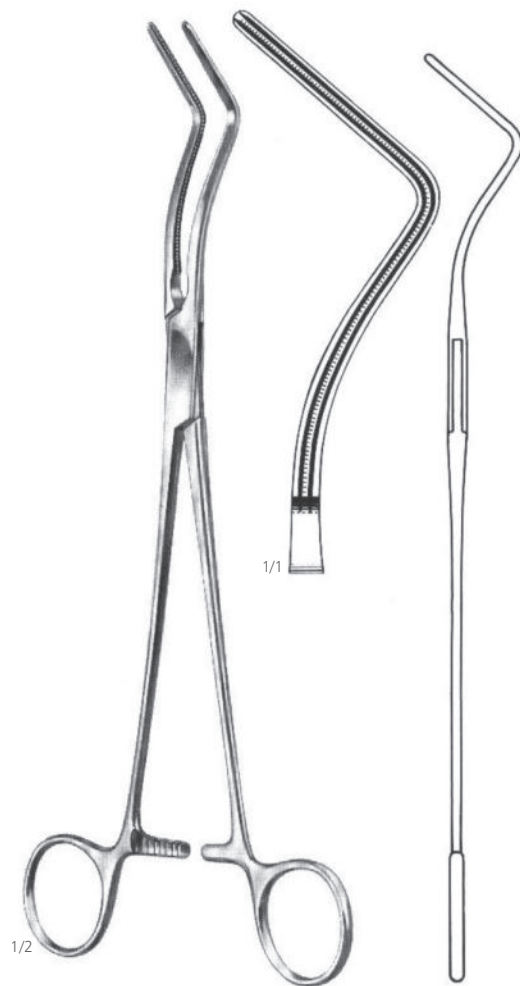

Lees
 14-537-25 25 cm



De Bakey
 14-550-17 
 17 cm

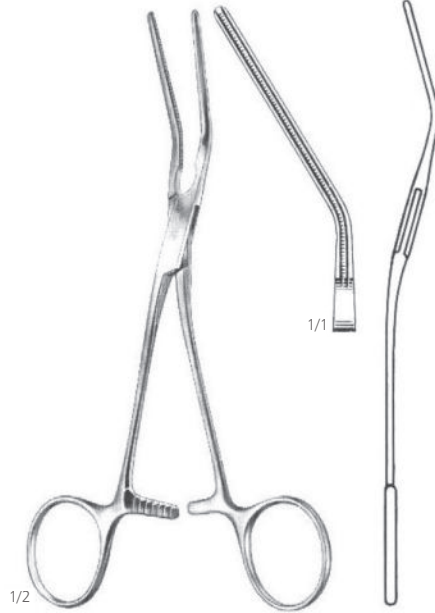

De Bakey
 14-551-16 
 16 cm

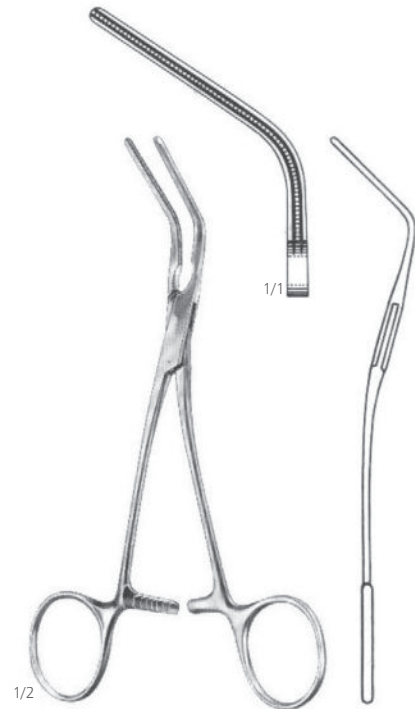

De Bakey
 14-553-15 
 15 cm



De Bakey
 14-555-15 
 15 cm



De Bakey
 14-557-17 
 17 cm

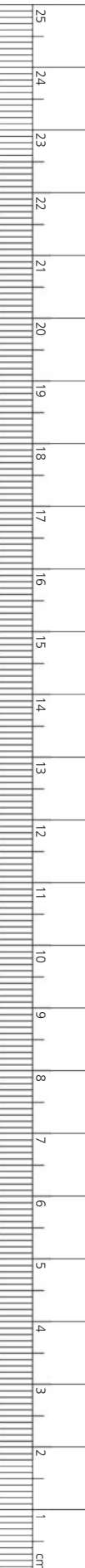

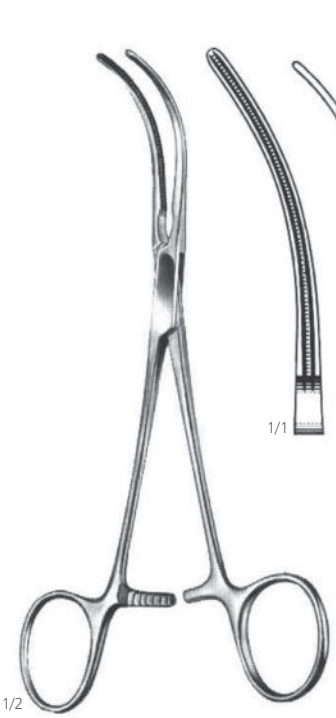

Glover
 14-559-17
 17 cm



Glover
 14-561-17
 17 cm



De Bakey
 14-563-01 - 14-563-02

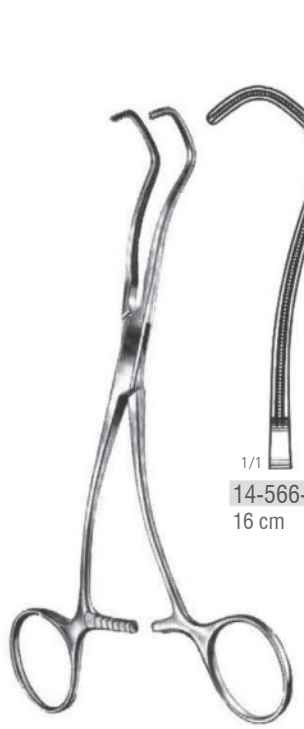

Derra
 14-566-16 - 14-566-18

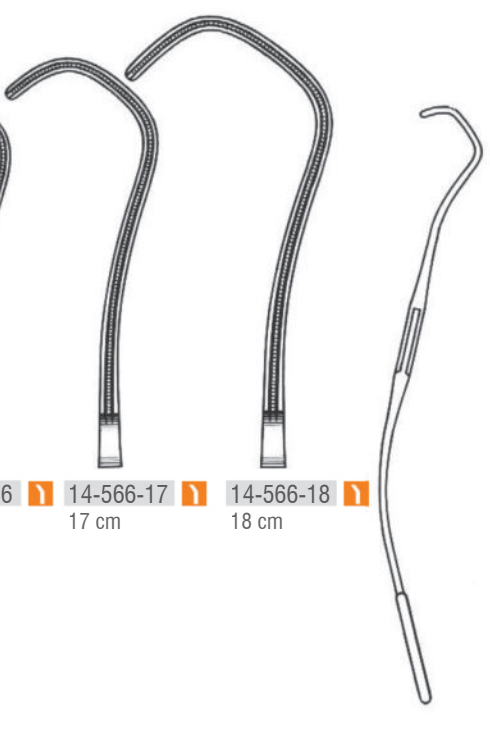

14-566-16 16 cm
 14-566-17 17 cm
 14-566-18 18 cm



De Bakey
 14-569-17
 17 cm



De Bakay
 14-580-10
 10 cm

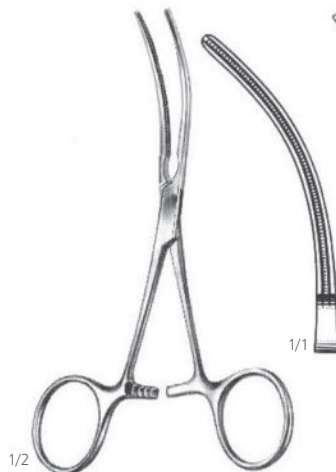

De Bakay
 14-580-11
 11 cm



De Bakay
 14-580-12
 12 cm

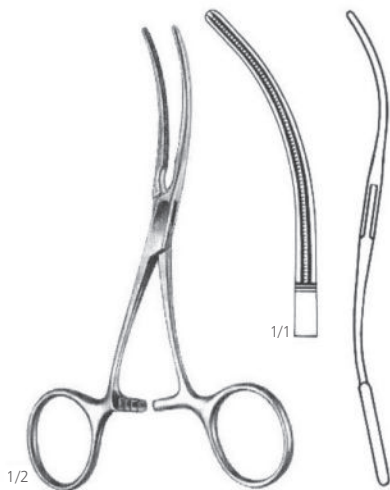

De Bakay
 14-584-12
 12 cm



De Bakay
 14-584-13
 13 cm

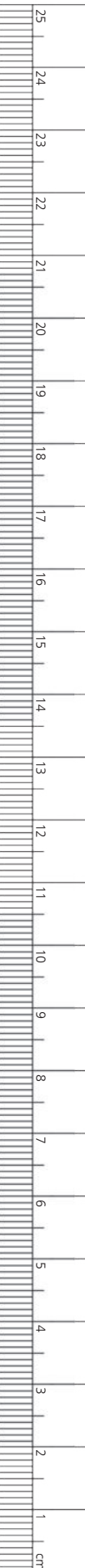



Cooley
 14-601-21 II
 21 cm

Cooley
 14-604-17 II
 17 cm

Cooley
 14-607-20 I
 20 cm

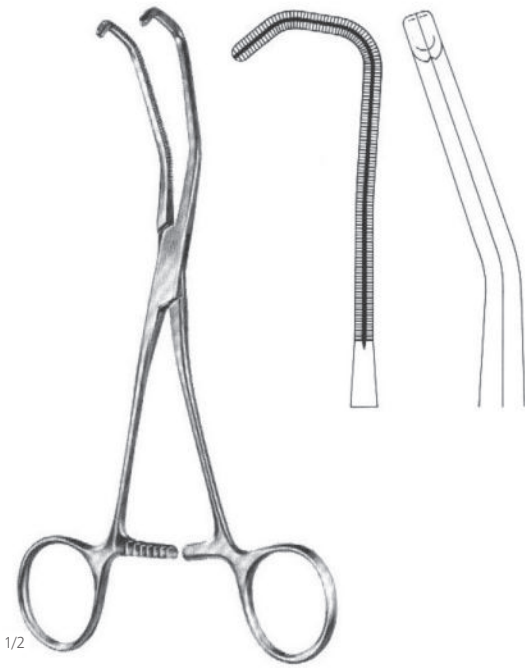

Cooley
 14-610-17 
 17 cm



Cooley
 14-611-16 
 16 cm



Cooley
 14-612-15 
 15 cm

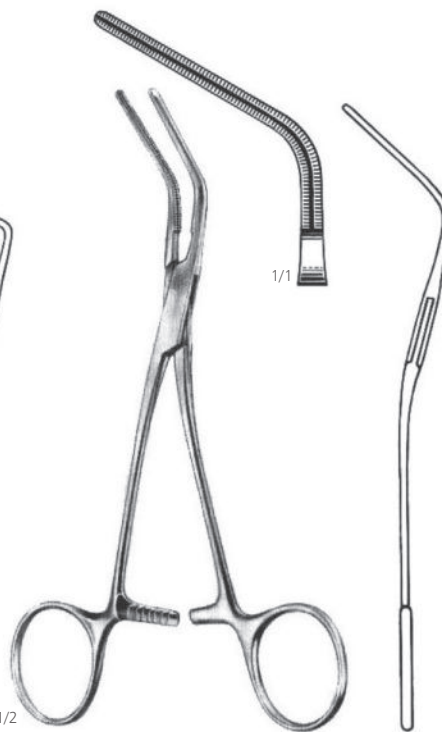

Cooley
 14-612-16 
 16 cm



Cooley
 14-612-17 
 17 cm

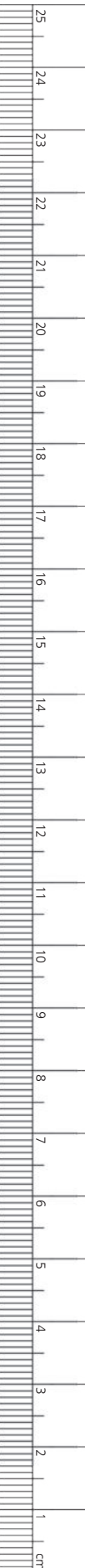

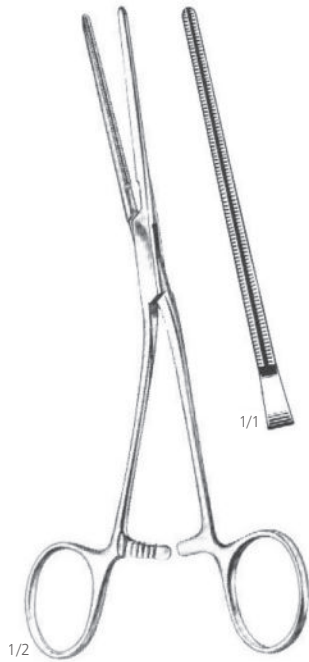

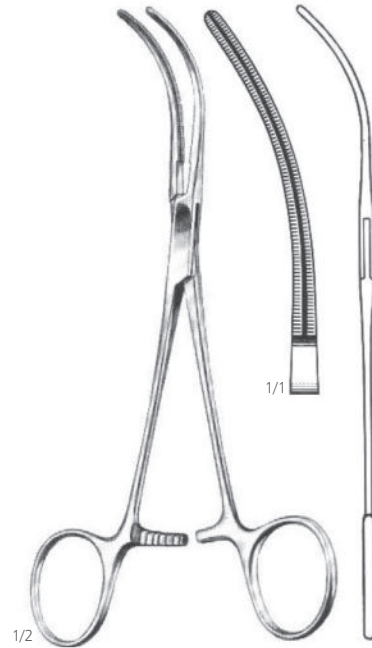

Cooley
 14-621-17 
 17 cm

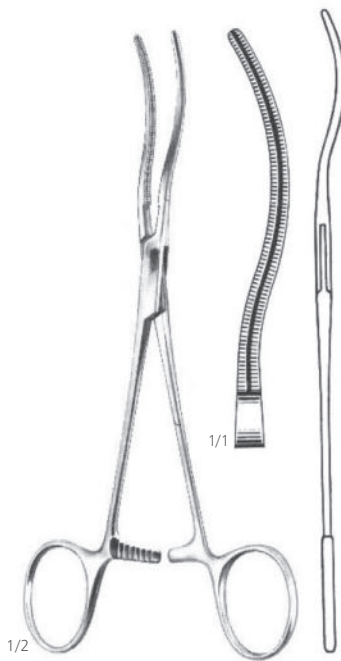

Cooley
 14-623-17 
 17 cm



Cooley
 14-625-17 
 17 cm



Cooley
 14-627-16 - 14-627-17

14-627-16 
 16 cm

14-627-17 
 17 cm



Cooley - Derra
 14-630-16 - 14-630-18

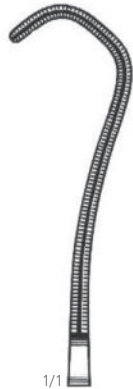

1/1
 14-630-16
 16 cm

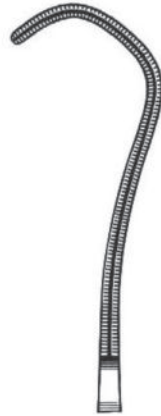

14-630-17
 17 cm



14-630-18
 18 cm



Cooley
 14-633-16
 16 cm

1/1



Beck
 14-636-17
 17 cm

1/1

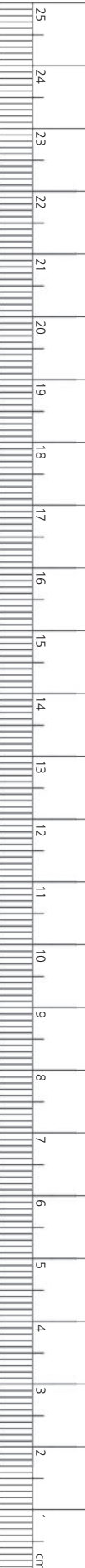

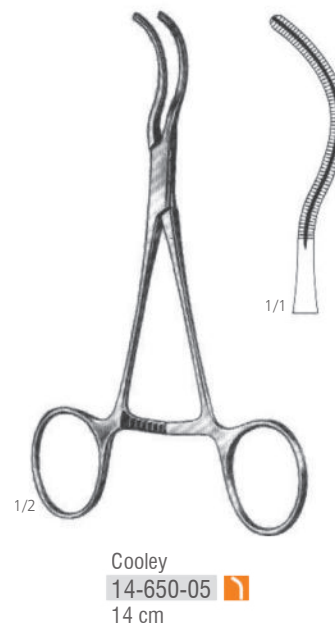

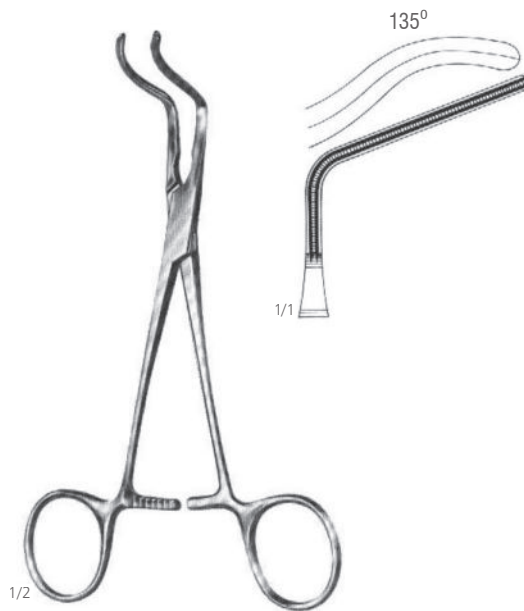

Subramanian - Maniature
 14-671-15 
 15.5 cm

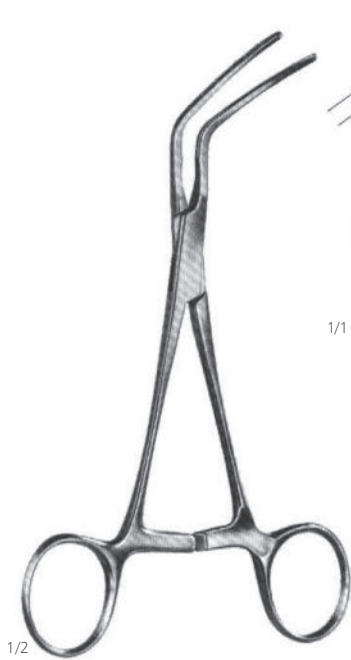

Subramanian
 14-673-16 
 16 cm

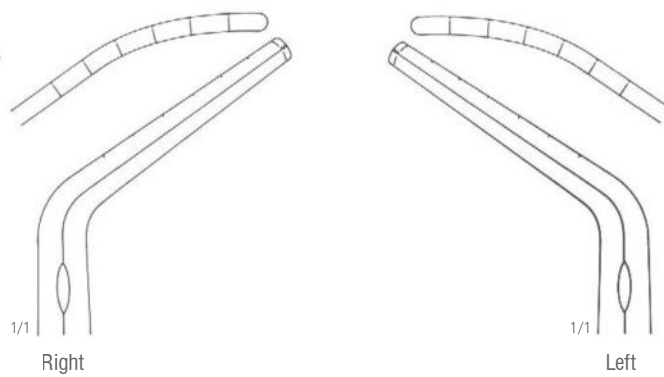

Subramanian
 14-675-16 
 16 cm

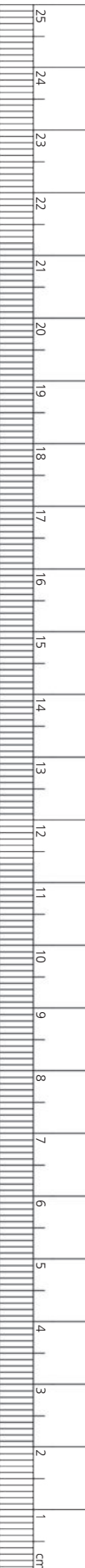



1/1
 Fig. 1
 14-691-01 
 14 cm



Fig. 2
 14-691-02 
 14 cm



Fig. 3
 14-691-03 
 14 cm



Fig. 4
 14-691-04 
 13 cm



Fig. 5
 14-691-05 
 14 cm



1/1
 Fig. 6
 14-691-06 
 13 cm



Fig. 7
 14-691-07 
 13 cm



Fig. 8
 14-691-08 
 14 cm



Fig. 9
 14-691-09 
 13.5 cm



14-691-01 - 14-691-09

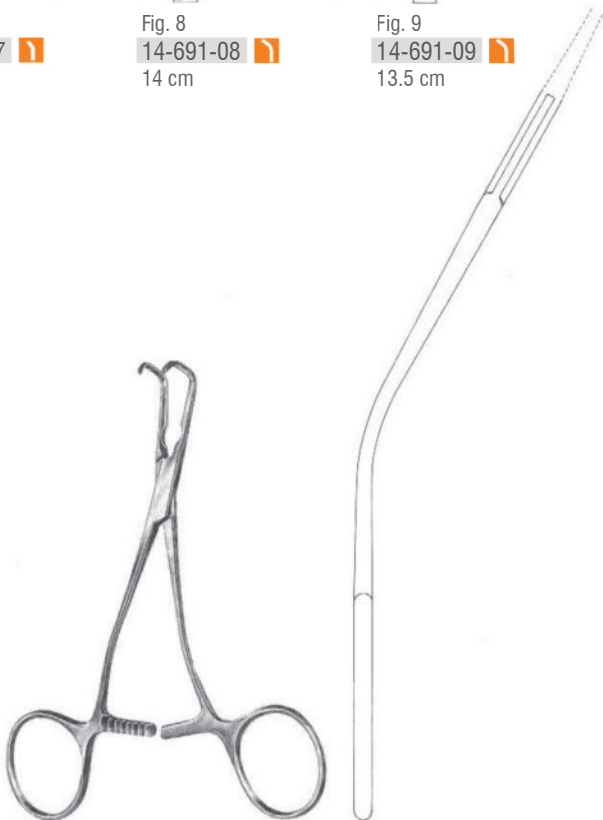

14-700-16 
16.5 cm

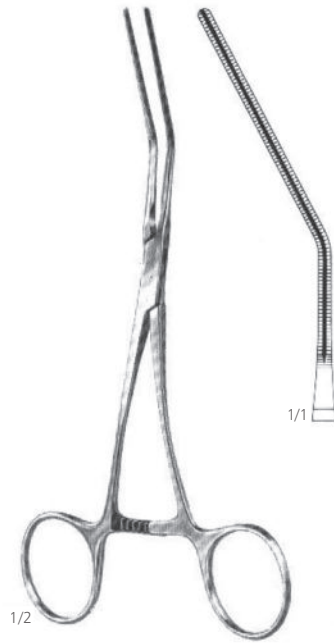

14-701-16 
16 cm



14-702-15 
15 cm



14-703-15 
15 cm

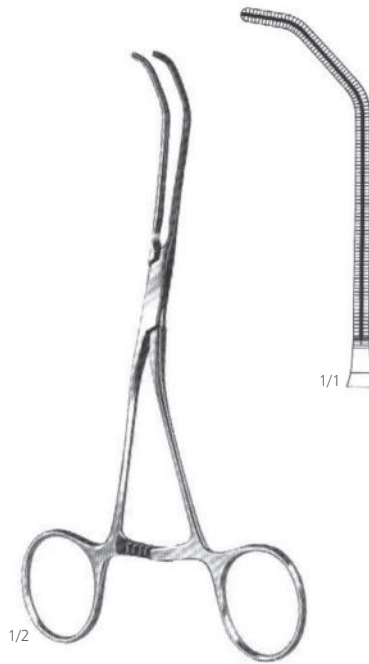

14-704-15 
15.5 cm

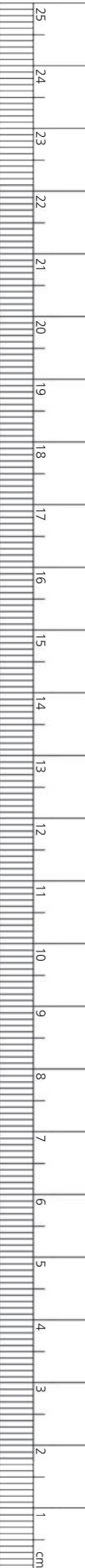



Castaneda
 14-713-01 - 14-713-04

Blade opening from 8 mm to 42 mm

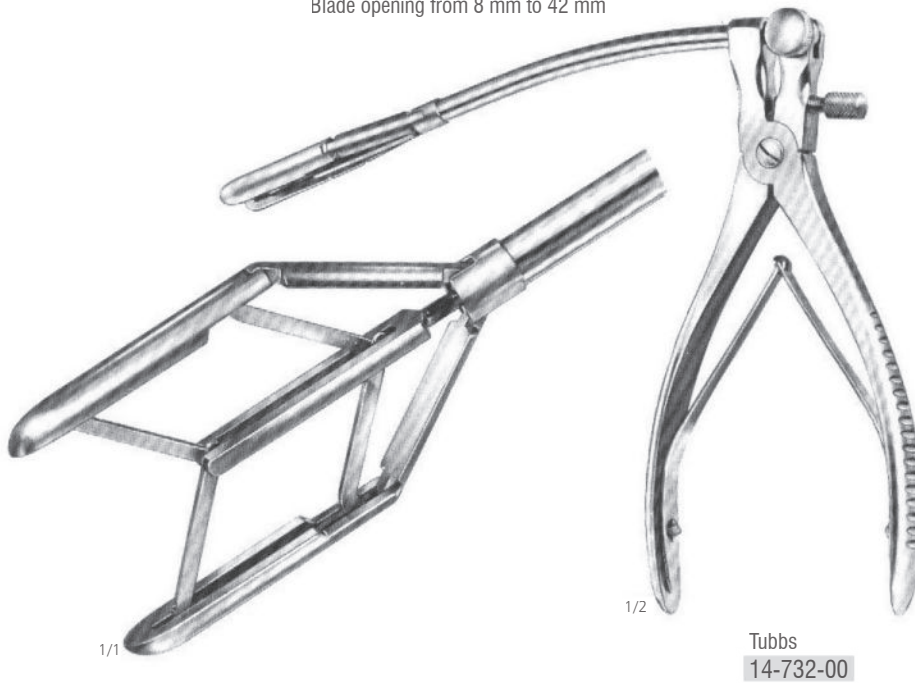

Tubbs
14-732-00

Blade opening from 8 mm to 15 mm

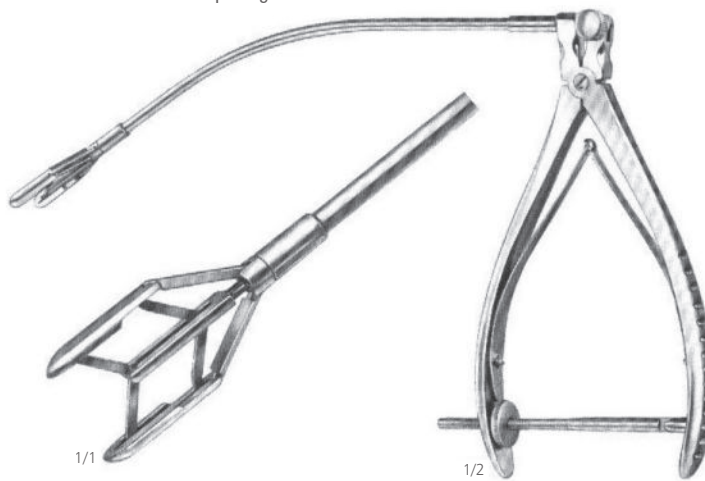

Cooley
14-736-00

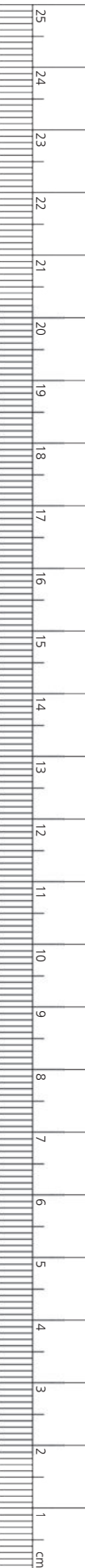



Rumel - Belmont
 14-740-33 Ø 3.5 mm
 14-742-33 Ø 6.5 mm
 33 cm



14-746-15 - 14-746-30
 26 cm

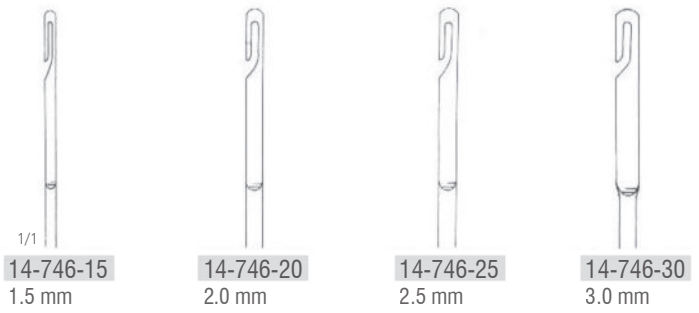



1/3

Satinsky
14-770-01 - 14-770-02
26 cm

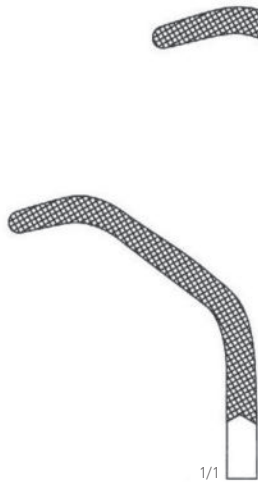

1/1

14-770-01

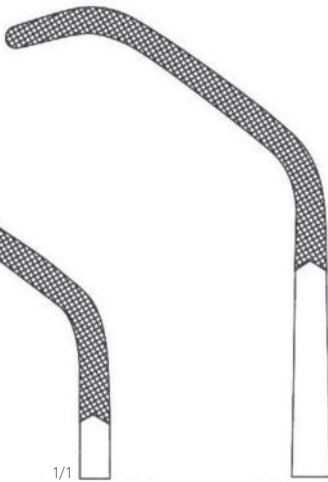

14-770-02



1/2

Baby - Satinsky
14-772-15
15 cm

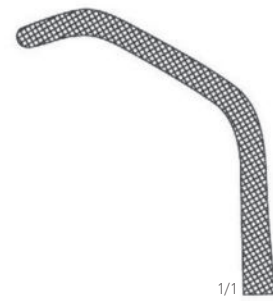

1/1



1/3

Satinsky
14-770-01 - 14-770-03
26 cm



1/1

14-770-01



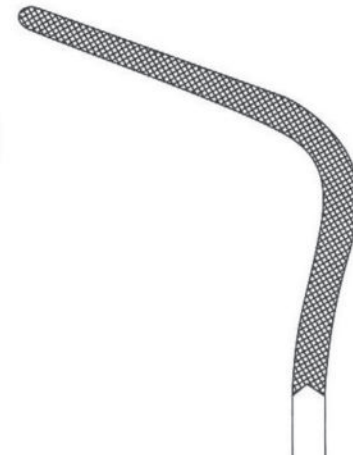

14-770-02

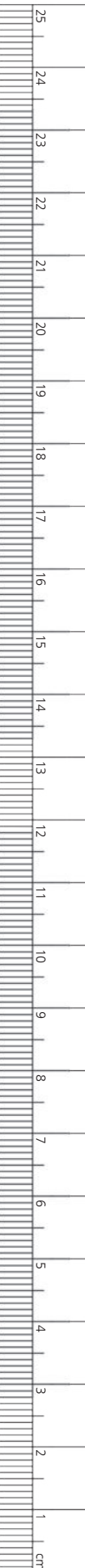

14-770-03

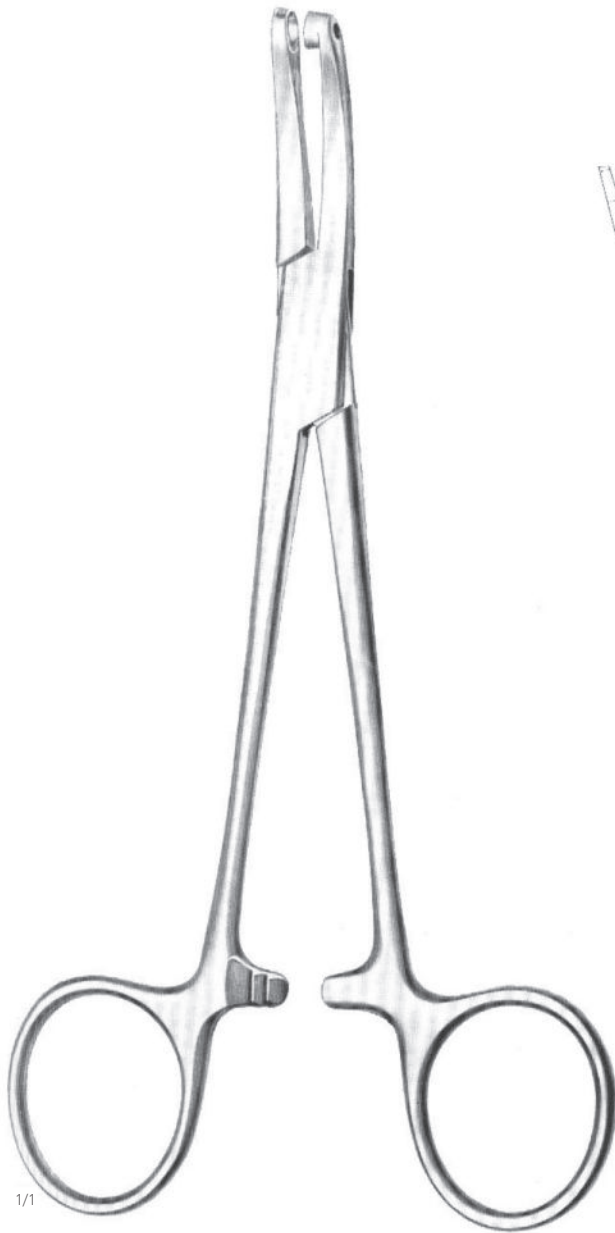

14-800-04 
Ø 4.0 mm14-800-05 
Ø 5.0 mm14-800-04 - 14-800-05
16 cm