

19

Bladder, Urology
Blase, Urologie
Vejiga, Urología
Vessie, urologie

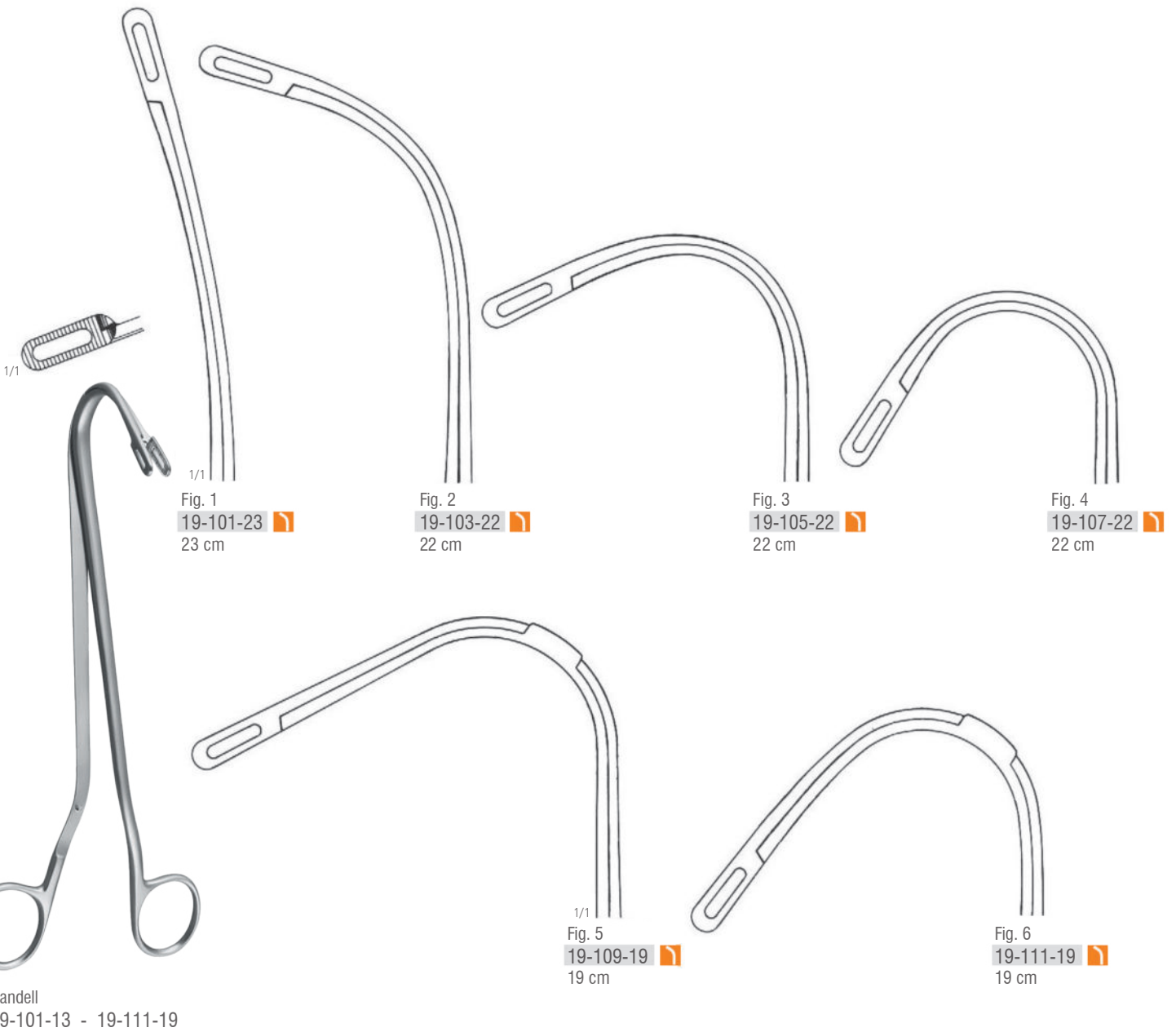





Elsasser
19-125-01 
20 cm
Fig. 1



Elsasser
19-125-02 
20 cm
Fig. 2

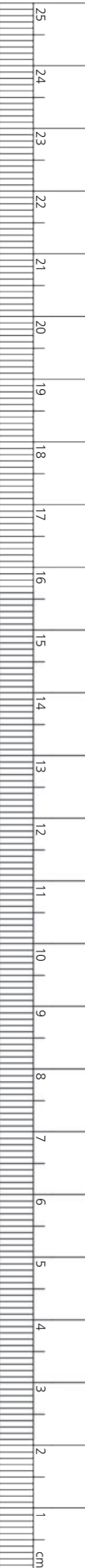



Guyon
19-140-26 
26.5 cm

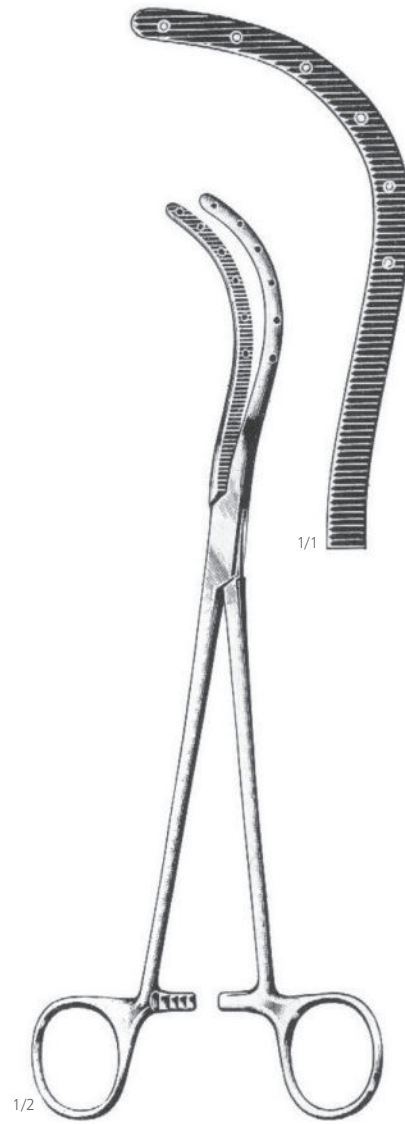

Guyon
19-144-23 
23.5 cm



Stille
19-148-24 
24 cm



Stille
19-152-22 
22 cm

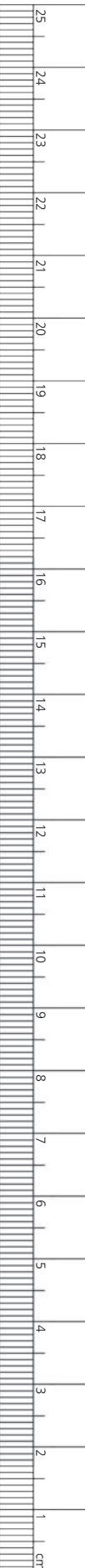



1/3

Collin
19-170-28
28.5 cm



2/5

Kocher
19-174-24
24 cm





1/2
 Moynihan
 19-200-34
 34 cm



1/2
 Desjardins
 19-206-02 - 19-206-06
 28 cm



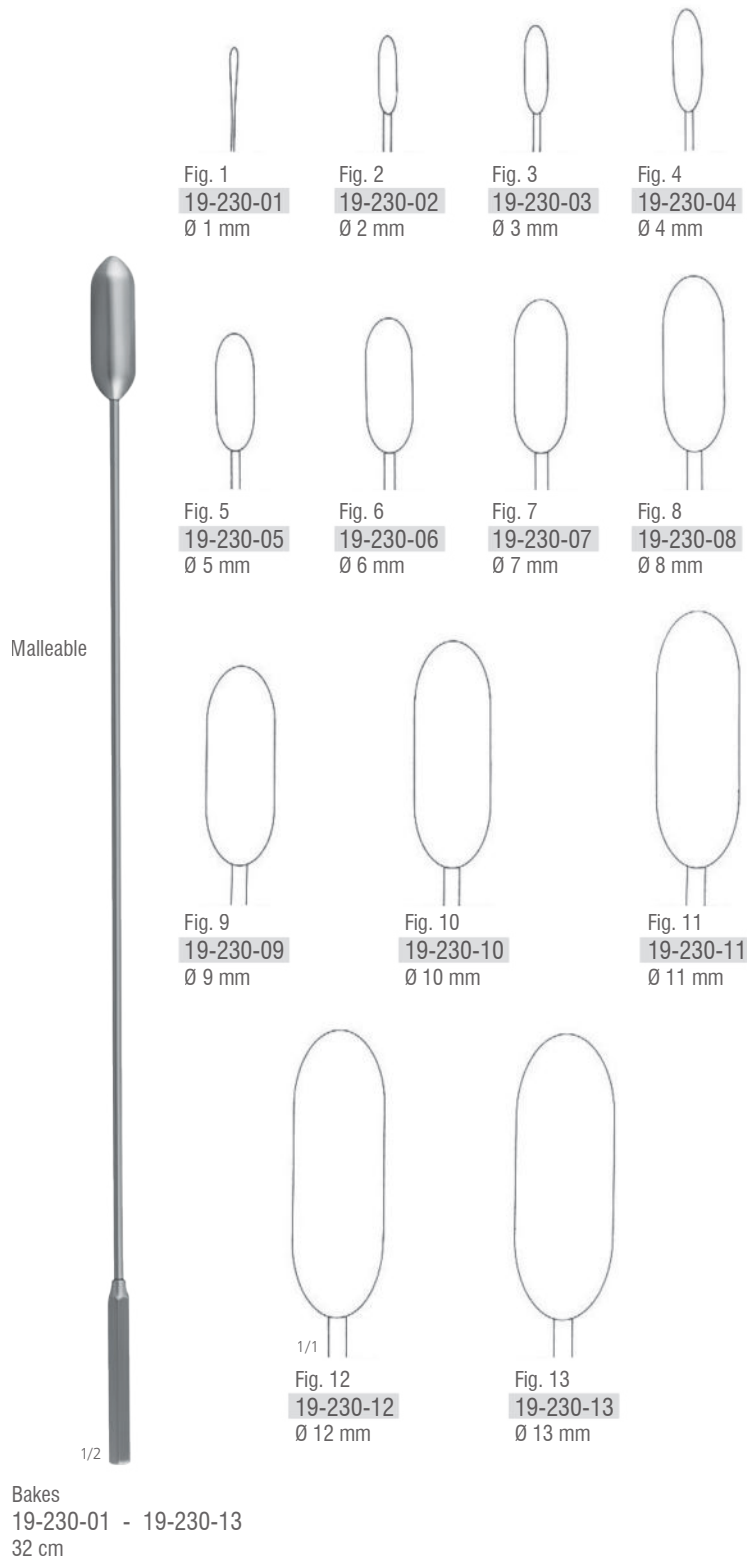

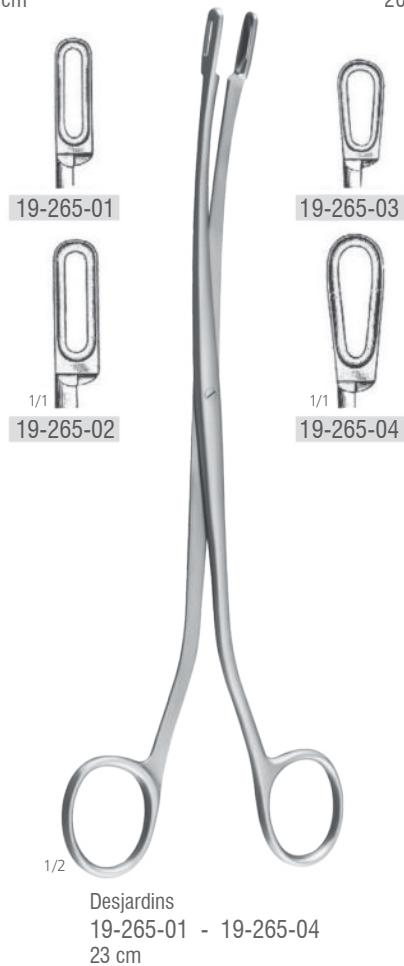

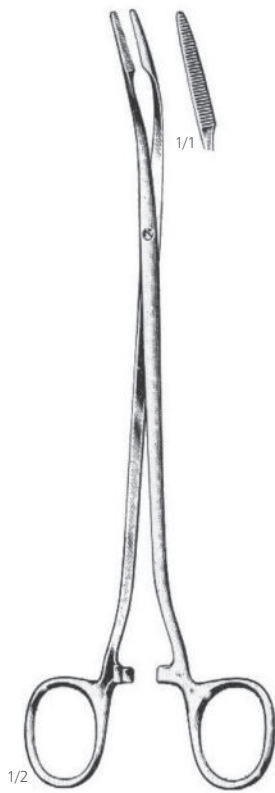

19-270-19 
19.5 cm



Czerny
19-274-24 
24.5 cm

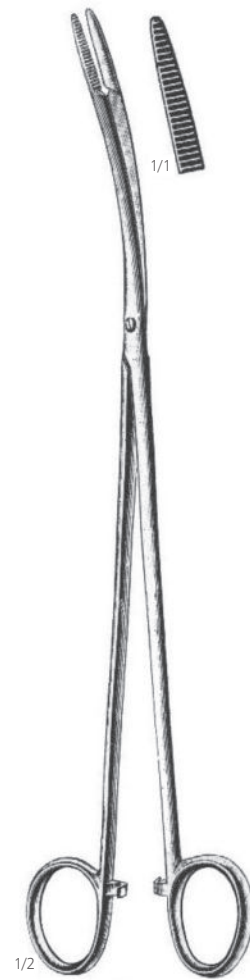

Pelkmann
19-278-26 
26.5 cm

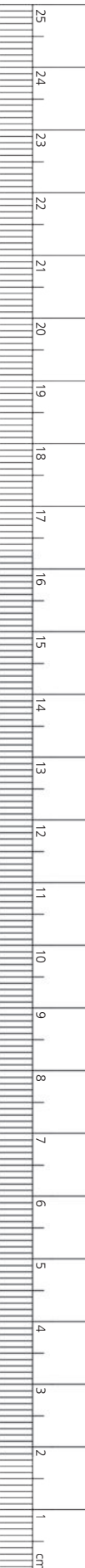

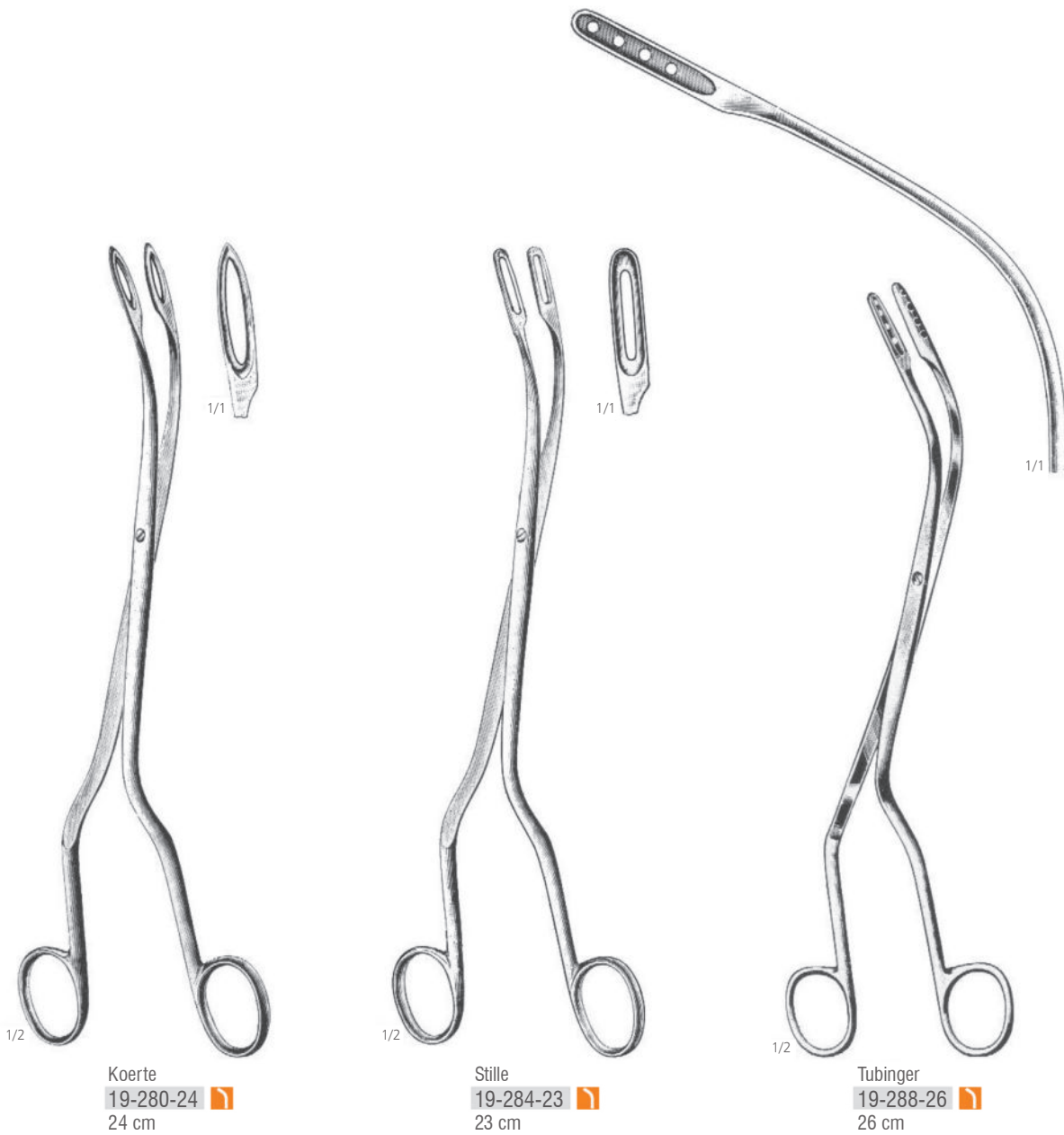

Malleable



1/2

Luer - Koerte
 19-300-01 - 19-300-08
 32 cm

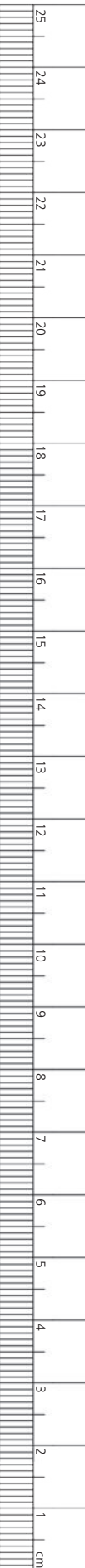
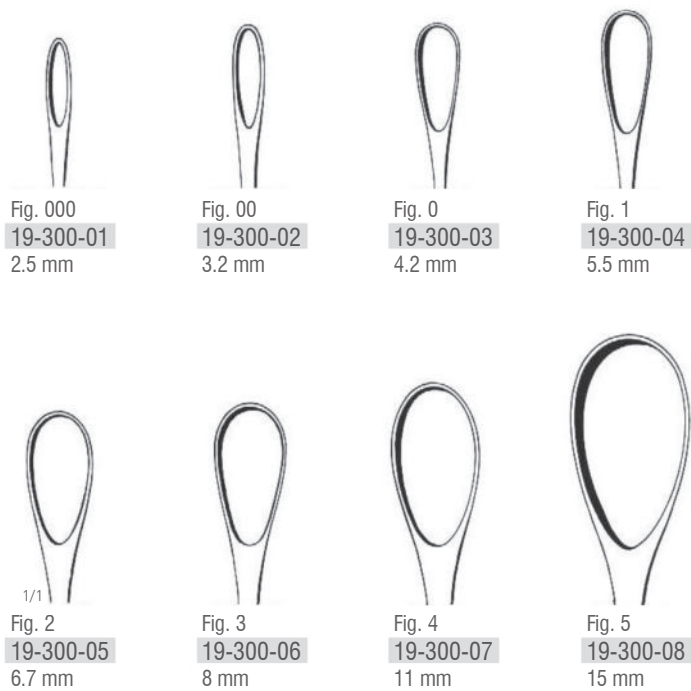

Gall Stone Scoops

Gallensteinloffel

Cucharillas para coger calculos biliares

Cuillères en pierre biliaire

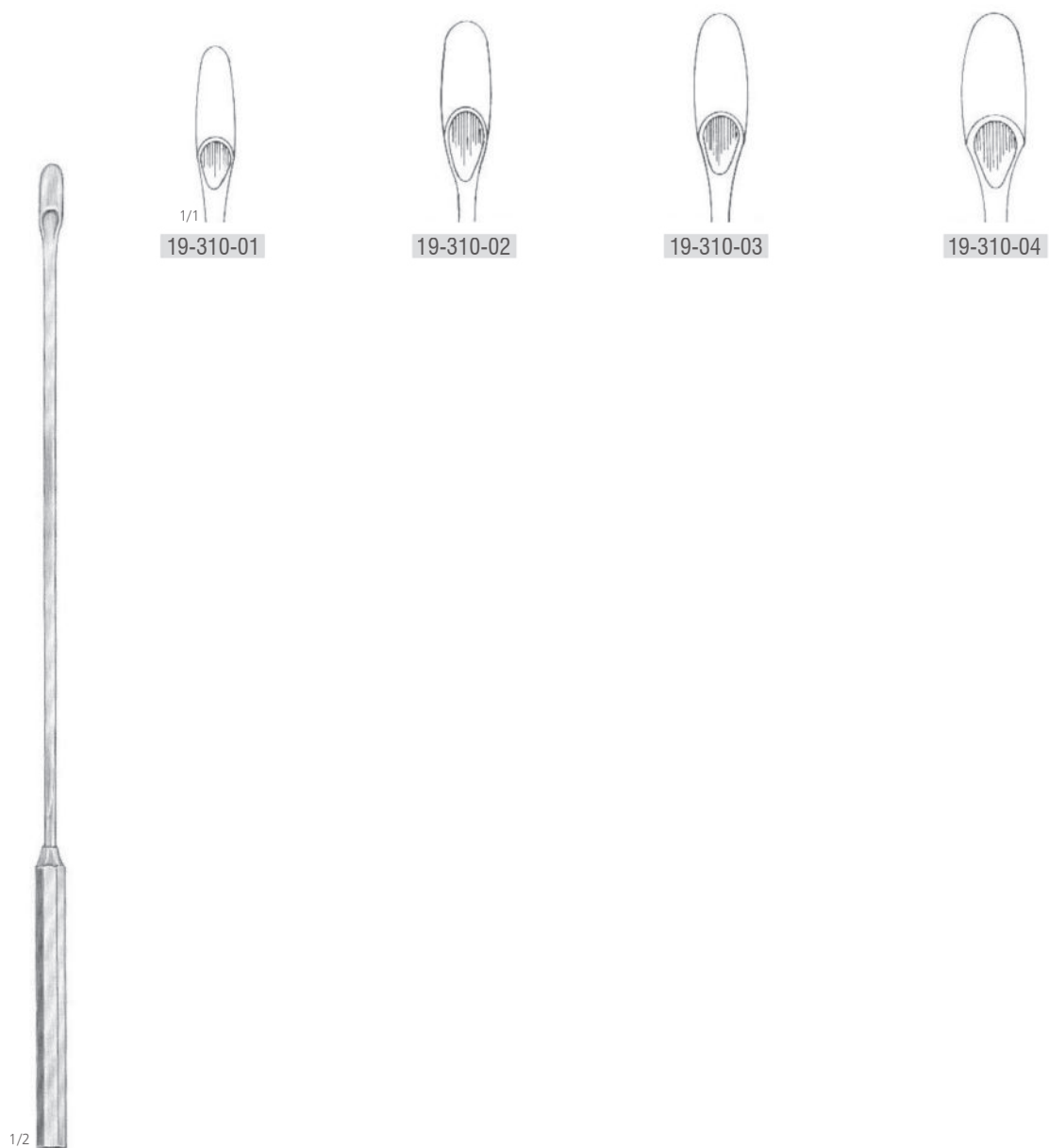

Desjardins
19-310-01 - 19-310-04
30 cm

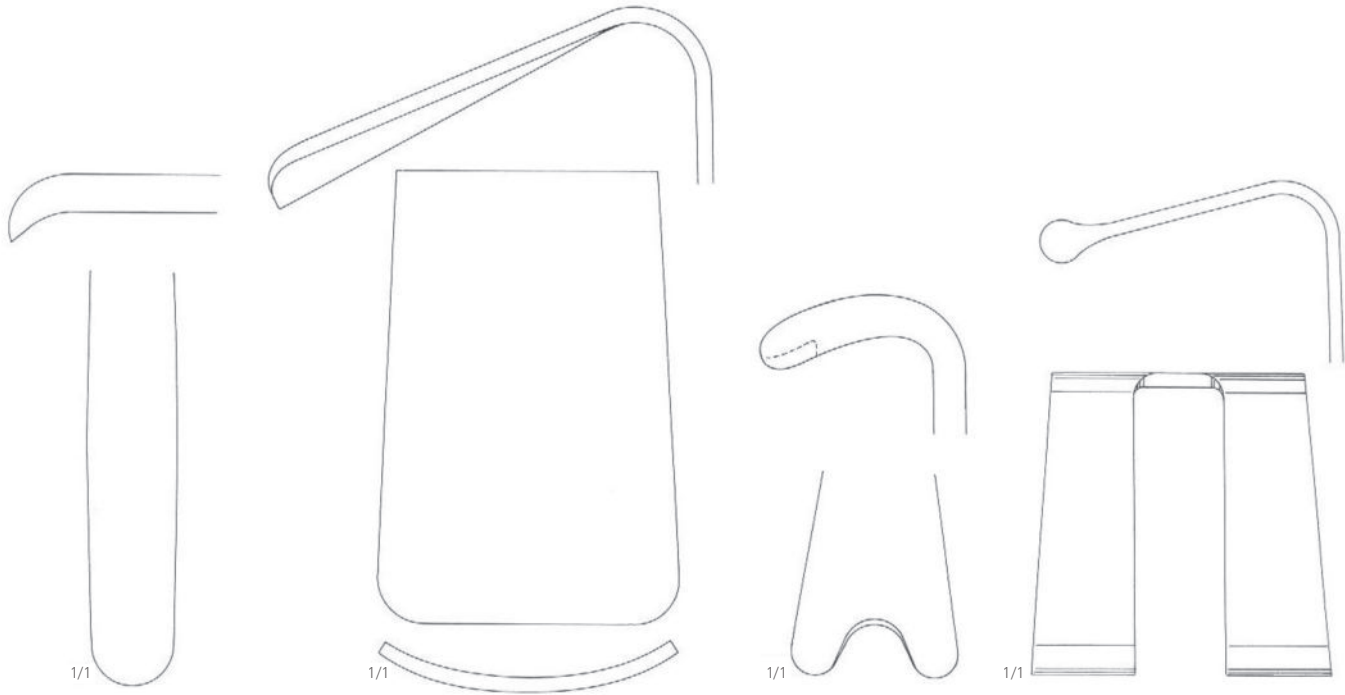

1/2
 Young
 19-351-21
 21.5 cm

1/2
 Young
 19-353-22
 22 cm

1/2
 Young
 19-355-21
 21 cm

1/2
 Young
 19-357-22
 22 cm



Capsule forceps

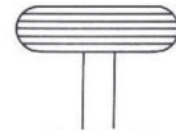

19-391-23 
 23 cm

Prostatic lobe holding forceps



19-393-23 
 23 cm

Capsule forceps

Atrauma



1/1

Capsule forceps



1/1

Ligature carrying forceps

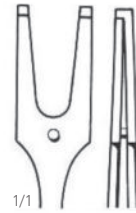

1/1

19-395-24 
 24 cm



1/2

Millin
 19-381-23 
 23.5 cm

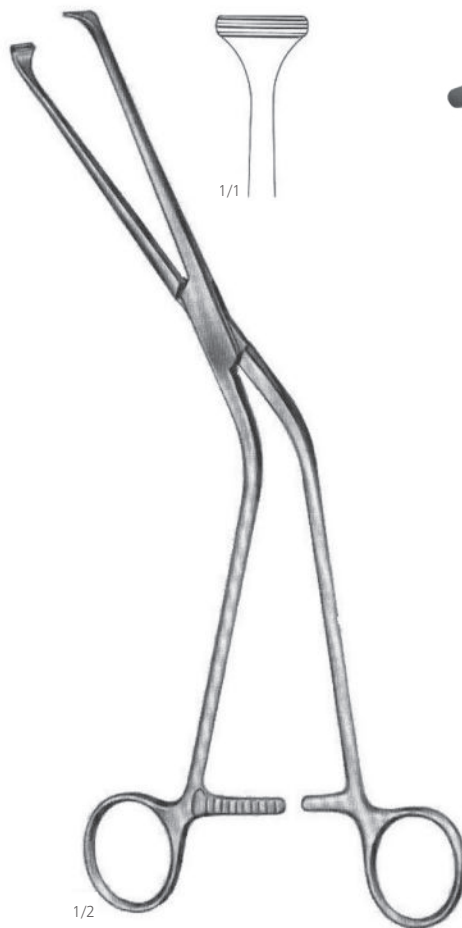

1/2

Millin
 19-383-24 
 24.5 cm



Millin
 19-391-23 - 19-395-24

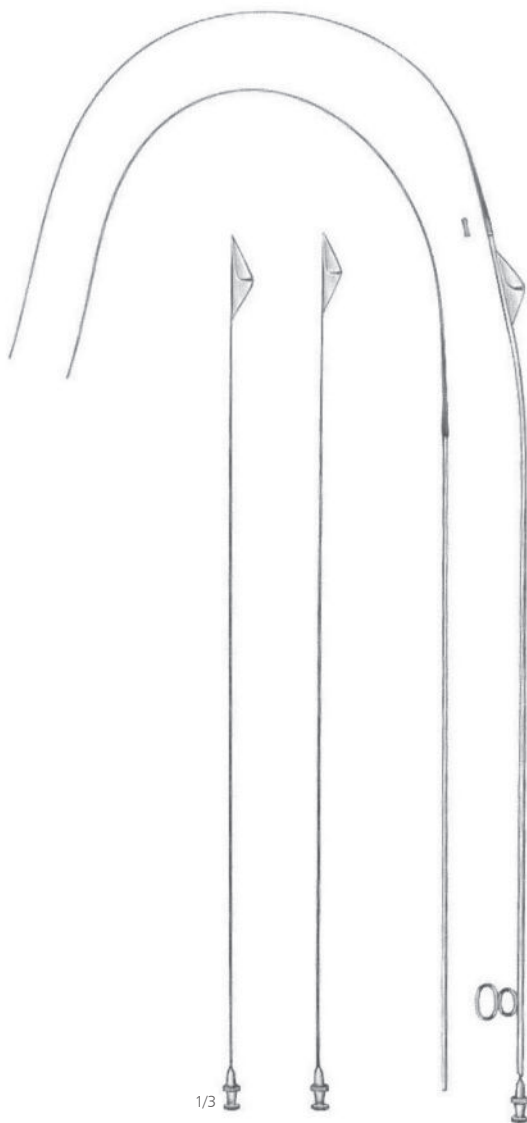

Maisonneuve
19-420-01

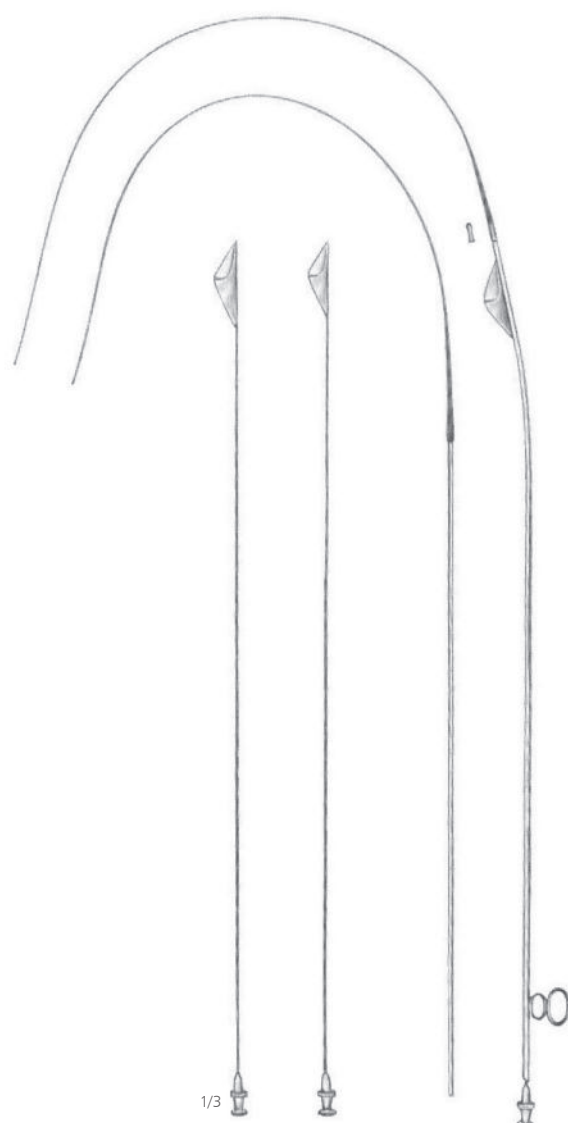

Maisonneuve
19-420-02

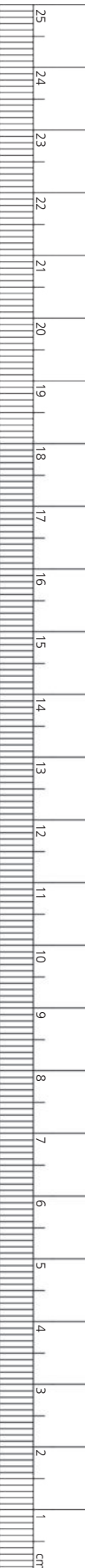

Meatus clamp



1/2

Millin
19-465-28
28 cm

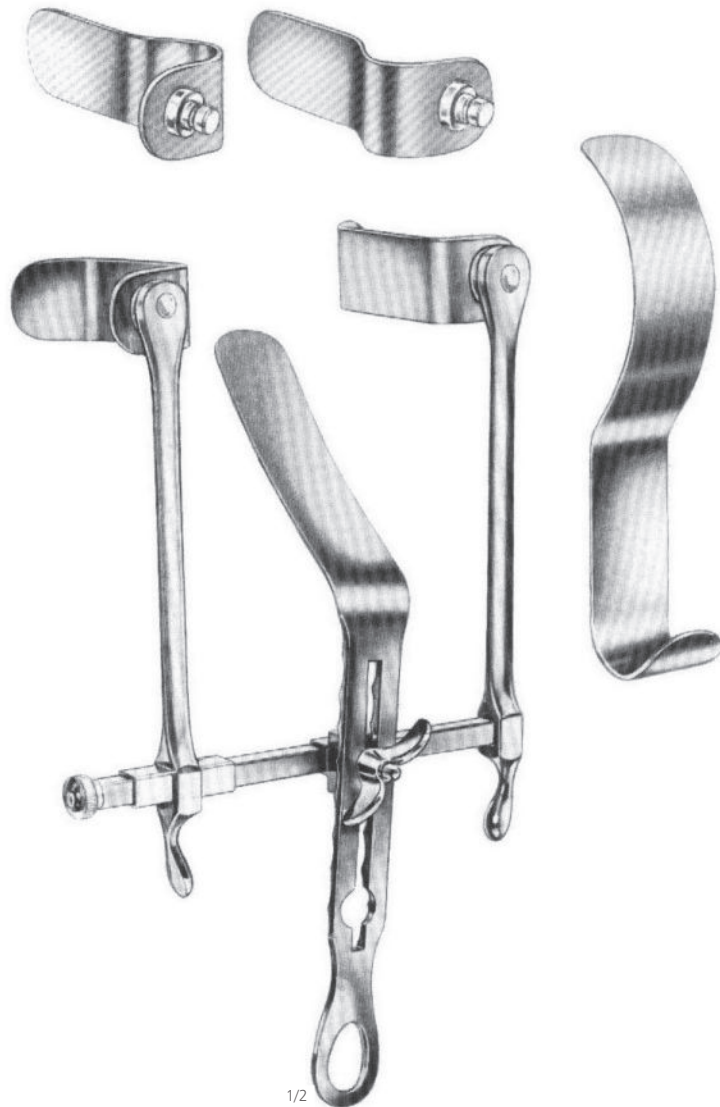

1/2

Thomas - Walker
19-481-00



110 mm

73 x 28 mm

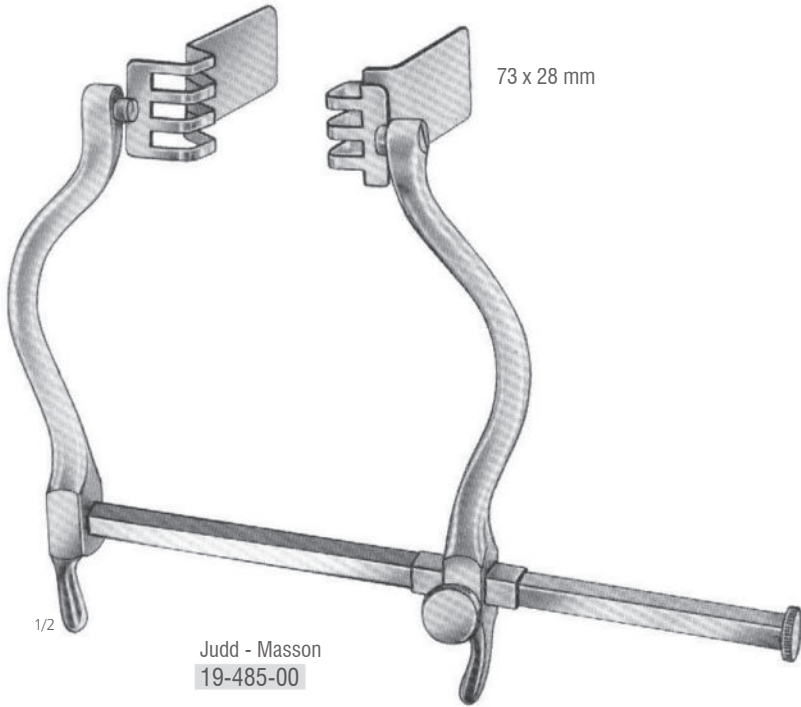

95 mm

27 x 60 mm



110 mm

73 x 28 mm

73 x 28 mm

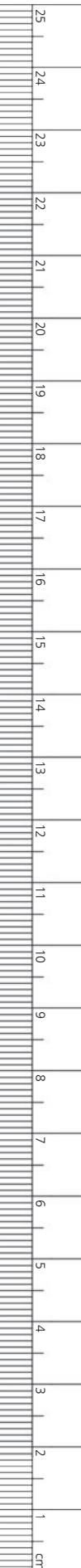
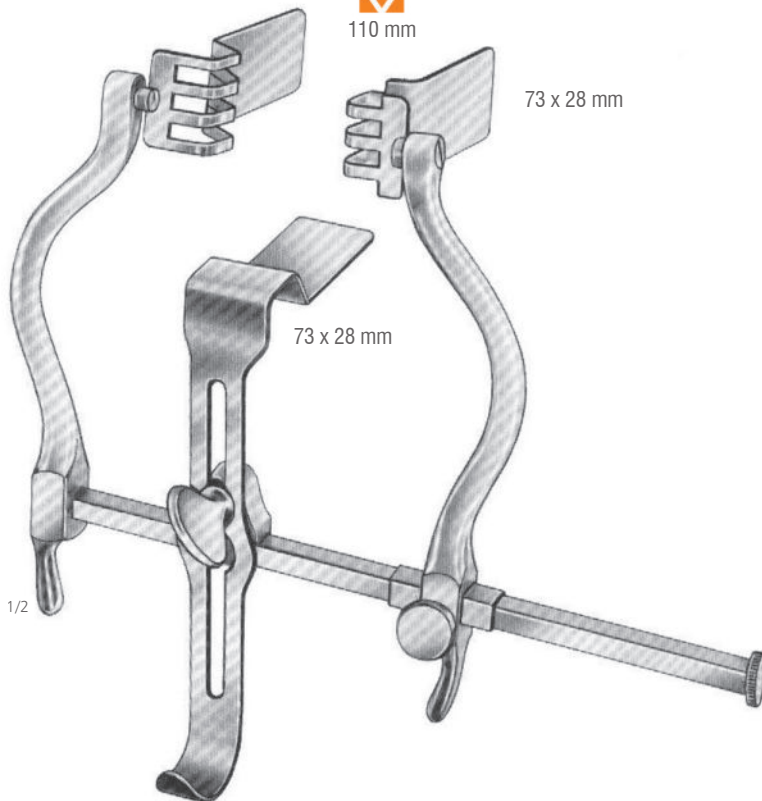



Millin	
19-550-00	Complete
19-550-45	x 1
19-550-57	x 2
19-550-80	x 2



Legueu
19-580-27
27 cm



Kocher
19-584-26
26 cm

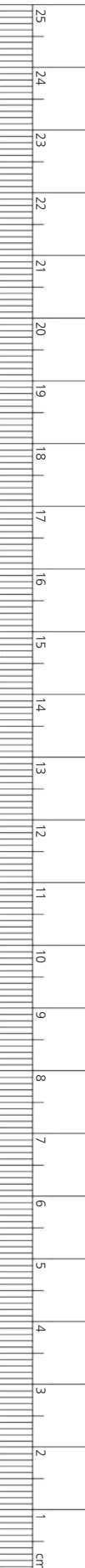

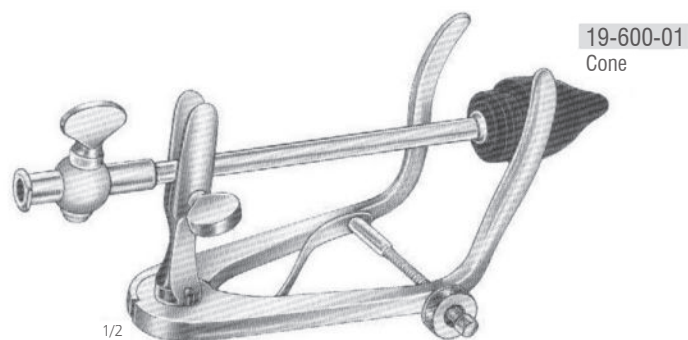
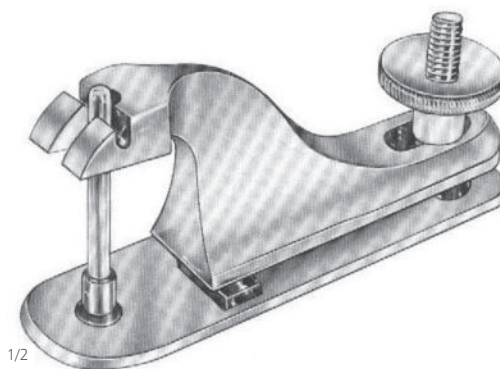
19-600-01
ConeKnutson
19-600-00
18 cm

19-610-08 - 19-610-32

19-610-08	Ø 8 mm
19-610-11	Ø 11 mm
19-610-13	Ø 13 mm
19-610-16	Ø 16 mm
19-610-21	Ø 21 mm
19-610-26	Ø 26 mm
19-610-32	Ø 32 mm

Ø mm	Charr./Fr.	Male Catheter	Female Catheter
2 2/3	8	-	19-656-08
3	9	-	-
3 1/3	10	19-650-10	19-656-10
3 2/3	11	19-650-11	-
4	12	19-650-12	19-656-12
4 1/3	13	19-650-13	-
4 2/3	14	19-650-14	19-656-14
5	15	19-650-15	-
5 1/3	16	19-650-16	19-656-16
5 2/3	17	19-650-17	-
6	18	19-650-18	19-656-18
6 1/3	19	19-650-19	-
6 2/3	20	19-650-20	19-656-20
7	21	19-650-21	-
7 1/3	22	19-650-22	19-656-22
7 2/3	23	19-650-23	-
8	24	19-650-24	19-656-24
8 1/3	25	19-650-25	-
8 2/3	26	19-650-26	19-656-26
9	27	19-650-27	-
9 1/3	28	19-650-28	19-656-28
9 2/3	29	19-650-29	-
10	30	19-650-30	19-656-30
10 2/3	32	-	19-656-32
11 1/3	34	-	19-656-34
12	36	-	19-656-36

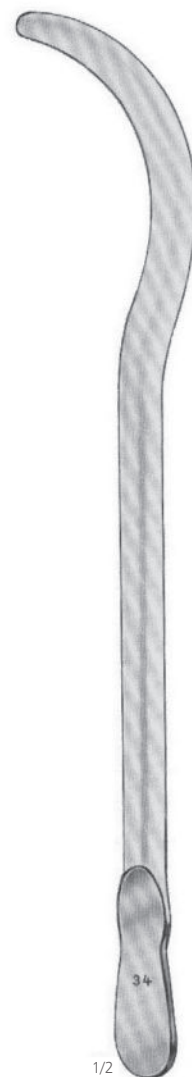

Guyon
19-650-10 - 19-650-30
27 cm

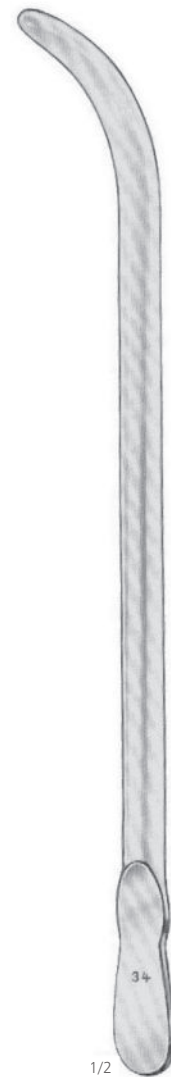

Van Buren
19-656-08 - 19-656-36
28 cm

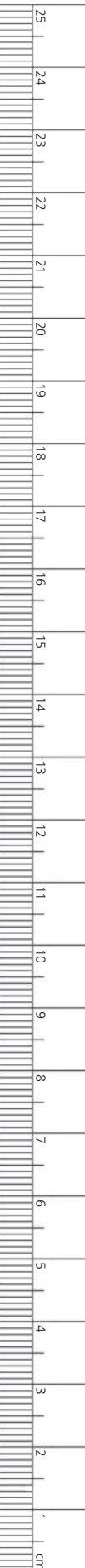

Ø mm	Charr./Fr.	Male Catheter	Female Catheter
2 2/3	8	19-660-08	19-666-08
3	9	19-660-06	19-666-06
3 1/3	10	19-660-10	19-666-10
3 2/3	11	19-660-11	19-666-11
4	12	19-660-12	19-666-12
4 1/3	13	19-660-13	19-666-13
4 2/3	14	19-660-14	19-666-14
5	15	19-660-15	19-666-15
5 1/3	16	19-660-16	19-666-16
5 2/3	17	19-660-17	19-666-17
6	18	19-660-18	19-666-18
6 1/3	19	19-660-19	19-666-19
6 2/3	20	19-660-20	19-666-20
7	21	19-660-21	19-666-21
7 1/3	22	19-660-22	19-666-22
7 2/3	23	19-660-23	19-666-23
8	24	19-660-24	19-666-24
8 1/3	25	19-660-25	19-666-25
8 2/3	26	19-660-26	19-666-26
9	27	19-660-27	19-666-27
9 1/3	28	19-660-28	19-666-28
9 2/3	29	19-660-29	19-666-29
10	30	19-660-30	19-666-30



1/2

Dittel
 19-660-08 - 19-660-30
 22.5 cm



1/2

Dittel
 19-666-08 - 19-666-30
 35.5 cm

Ø mm	Charr./Fr.	Male Catheter	Female Catheter
2	6	19-670-06	19-676-06
2 1/3	7	19-670-07	19-676-07
2 2/3	8	19-670-08	19-676-08
3	9	19-670-09	19-676-09
3 1/3	10	19-670-10	19-676-10
3 2/3	11	19-670-11	19-676-11
4	12	19-670-12	19-676-12
4 1/3	13	19-670-13	19-676-13
4 2/3	14	19-670-14	19-676-14
5	15	19-670-15	19-676-15
5 1/3	16	19-670-16	19-676-16
5 2/3	17	19-670-17	19-676-17
6	18	19-670-18	19-676-18
6 1/3	19	19-670-19	19-676-19
6 2/3	20	19-670-20	19-676-20
7	21	19-670-21	19-676-21
7 1/3	22	19-670-22	19-676-22
7 2/3	23	19-670-23	19-676-23
8	24	19-670-24	19-676-24



Male Catheter
19-670-06 - 19-670-24



Female Catheter
19-676-06 - 19-676-24

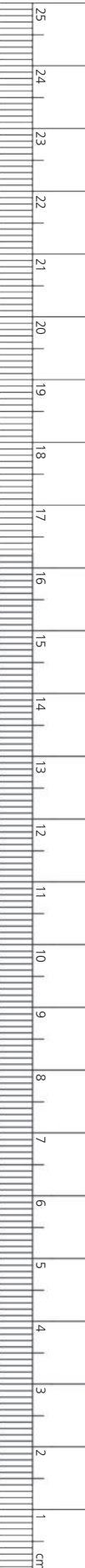

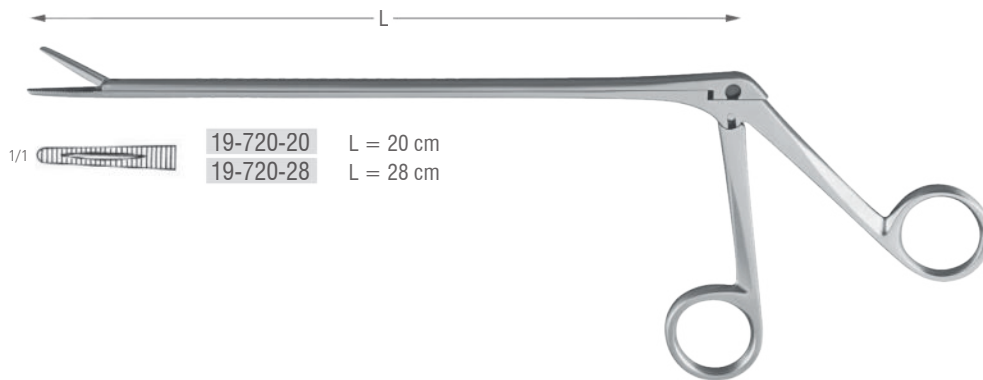

19-720-20	L = 20 cm
19-720-28	L = 28 cm

Mathieu
 19-720-20 - 19-720-28

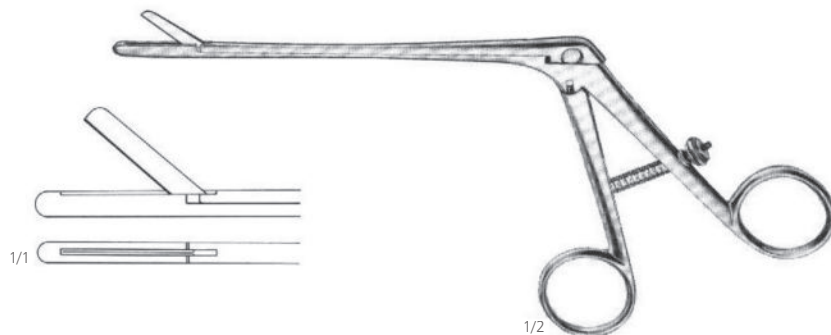

Sachse
 19-725-12



1/3
 Guyon
 19-740-39
 39 cm



1/3
 Guyon
 19-741-35
 35 cm



1/2
 Stockmann
 19-753-08
 8 cm



1/2
 Stockmann
 19-755-08
 8 cm



1/2
 Strauss
 19-757-11
 11 cm

