

06

Forceps
Zange
Fórceps
Forceps



Forceps - Zange - Fórceps - Pincas

Dressing Forceps
Anatomische Pinzetten
Pinzas de diseccion
Pincas à dissection



Standard
06-100-10 - 06-100-30



06-100-10 ||
10.5 cm



06-100-11 ||
11.5 cm

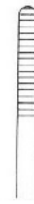

06-100-13 ||
13 cm

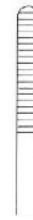

06-100-14 ||
14.5 cm

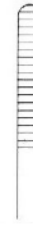

06-100-16 ||
16 cm

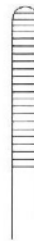

06-100-18 ||
18 cm

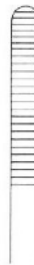

06-100-20 ||
20 cm

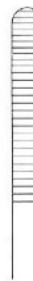

06-100-25 ||
25 cm



06-100-30 ||
30 cm



Narrow
06-110-11 - 06-110-30



06-110-11 ||
11 cm



06-110-13 ||
13 cm



06-110-14 ||
14.5 cm



06-110-16 ||
16 cm



06-110-18 ||
18 cm

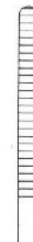

06-110-20 ||
20 cm

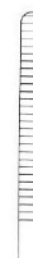

06-110-25 ||
25 cm

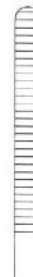









06-110-30 ||
30 cm











06-115-14



06-117-14

Standard		
06-115-10	10.5 cm	
06-115-11	11.5 cm	
06-115-13	13.0 cm	
06-115-14	14.5 cm	
06-115-16	16.0 cm	
06-115-18	18.0 cm	
06-115-20	20.0 cm	
06-115-25	25.0 cm	
06-115-30	30.0 cm	

Narrow		
06-117-10	10.5 cm	
06-117-11	11.5 cm	
06-117-13	13.0 cm	
06-117-14	14.5 cm	
06-117-16	16.0 cm	
06-117-18	18.0 cm	
06-117-20	20.0 cm	
06-117-25	25.0 cm	
06-117-30	30.0 cm	

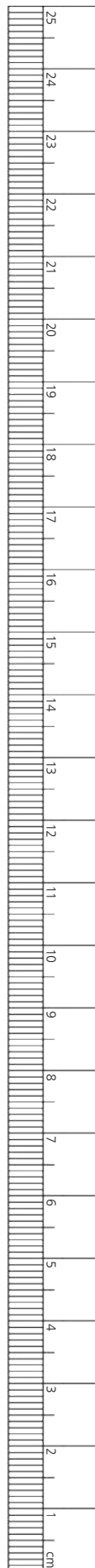

Forceps - Zange - Fórceps - Pincas

06

Dressing Forceps
 Anatomische Pinzetten
 Pinzas de diseccion
 Pincas à dissection



1/2
 McIndoe
 06-120-15 II
 15 cm

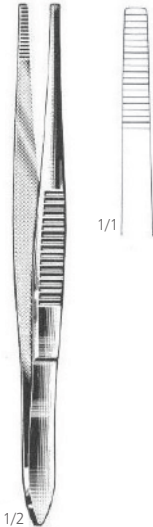

1/2
 Stille
 06-124-15 II
 15 cm

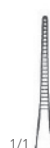

06-130-12 II
 12 cm



06-130-15 II
 15 cm

Micro - Adson
 06-130-12 - 06-130-15



06-132-12 II
 12 cm



06-132-15 II
 15 cm

Adson
 06-132-12 - 06-132-15



Modell USA

06-140-12	12.0 cm	II
06-140-13	13.0 cm	II
06-140-14	14.5 cm	II
06-140-15	15.5 cm	II
06-140-18	18.0 cm	II
06-140-21	21.0 cm	II
06-140-25	25.0 cm	II
06-140-31	31.0 cm	II



Modell USA

06-142-12	12.0 cm	II
06-142-13	13.0 cm	II
06-142-14	14.5 cm	II
06-142-15	15.5 cm	II



Ewald (Hudson)

06-146-12	12 cm	II
-----------	-------	----



Semken

06-150-12	12 cm	II
06-150-15	15 cm	II

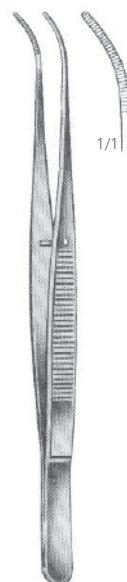

Semken

06-151-12	12 cm	II
06-151-15	15 cm	II

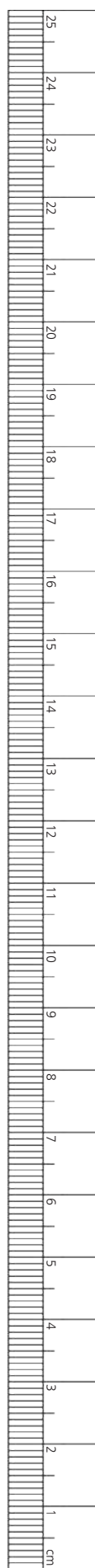

Forceps - Zange - Fórceps - Pincas

06

Dressing Forceps
Anatomische Pinzetten
Pinzas de diseccion
Pincas à dissection



06-164-17

Taylor
06-164-17 - 06-165-17
17 cm



Taylor
06-170-17
17.5 cm



Taylor
06-170-18
18.5 cm



06-174-06
0.6 cm



06-174-08
0.8 cm



06-174-10
1.0 cm

06-174-06 - 06-174-10
15.5 cm



06-176-18



06-177-18



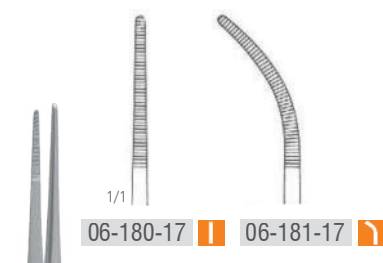
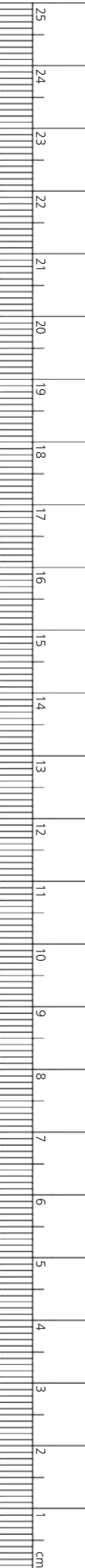



Gerald
06-176-18 - 06-177-18
18 cm



06-180-17  06-181-17 

Cushing
06-180-17 - 06-181-17
17.5 cm



06-184-18  18 cm
06-184-21  21 cm
06-184-25  25 cm
06-185-18  18 cm
06-185-21  21 cm
06-185-25  25 cm

Cushing
06-184-18 - 06-185-25

Forceps - Zange - Fórceps - Pincas

06

Dressing Forceps
 Anatomische Pinzetten
 Pinzas de diseccion
 Pincas à dissection

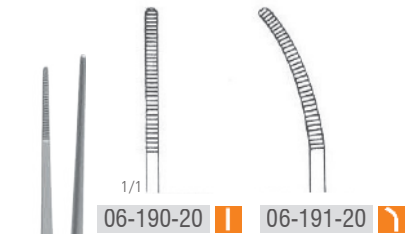

1/2
 Brophy
 06-190-20 - 06-191-20
 20 cm



1/2
 Dührssen
 06-194-20
 20 cm





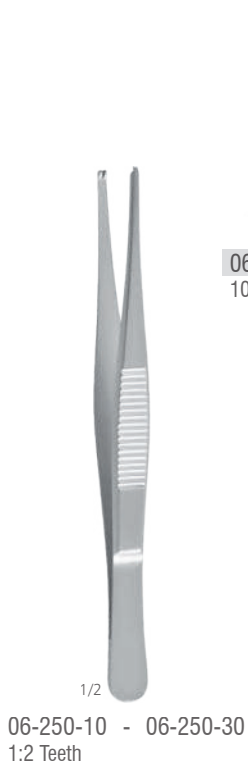











Wangensteen
 06-198-15 15 cm
 06-198-23 23 cm



 1/1	 1/1	 1/1	 1/1	 1/1
06-250-10 	06-250-11 	06-250-13 	06-250-14 	06-250-16 
10.5 cm	11.5 cm	13 cm	14.5 cm	16 cm
	 1/1	 1/1	 1/1	 1/1
	06-250-18 	06-250-20 	06-250-25 	06-250-30 
	18 cm	20 cm	25 cm	30 cm



 2/3	 2/3	 2/3	 2/3
06-252-11 	06-252-13 	06-252-14 	06-252-16 
11.5 cm	13 cm	14.5 cm	16 cm
	 2/3	 2/3	 2/3
	06-252-18 	06-252-20 	06-252-25 
	18 cm	20 cm	25 cm

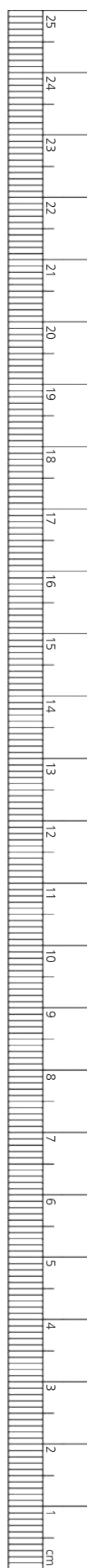

Forceps - Zange - Fórceps - Pincas

06

Tissue Forceps
 Chirurgische Pinzetten
 Pinzas de disección con diente
 Pincas à dissection à griffes

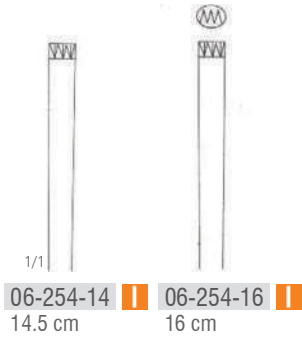

06-254-14 14.5 cm
 06-254-16 16 cm

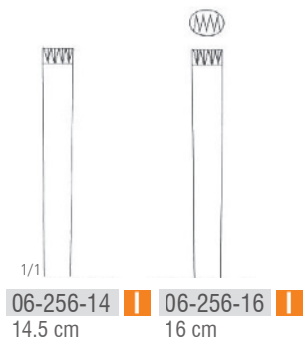

06-256-14 14.5 cm
 06-256-16 16 cm

- 06-254-13 13.0 cm
 - 06-254-14 14.5 cm
 - 06-254-16 16.0 cm
- 3:4 Teeth

- 06-256-13 13.0 cm
 - 06-256-14 14.5 cm
 - 06-256-16 16.0 cm
- 4:5 Teeth

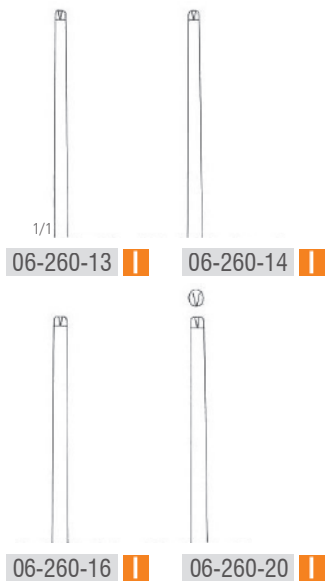

06-260-13
 06-260-14
 06-260-16
 06-260-20



- 06-261-10 10.5 cm
 - 06-261-11 11.5 cm
 - 06-261-13 13.0 cm
 - 06-261-14 14.5 cm
 - 06-261-16 16.5 cm
 - 06-261-18 18.0 cm
 - 06-261-20 20.0 cm
 - 06-261-25 25.0 cm
 - 06-261-30 30.0 cm
- 1:2 Teeth

- 06-260-10 10.5 cm
 - 06-260-11 11.5 cm
 - 06-260-13 13.0 cm
 - 06-260-14 14.5 cm
 - 06-260-16 16.5 cm
 - 06-260-18 18.0 cm
 - 06-260-20 20.0 cm
 - 06-260-25 25.0 cm
 - 06-260-30 30.0 cm
- 1:2 Teeth



06-270-12 ■
12 cm



06-270-15 ■
15 cm



1/2
Micro - Adson
06-272-12 ■
12 cm
1:2 Teeth

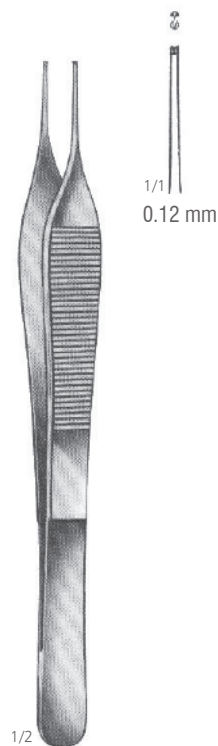

1/2
Micro - Adson
06-272-15 ■
15 cm
1:2 Teeth

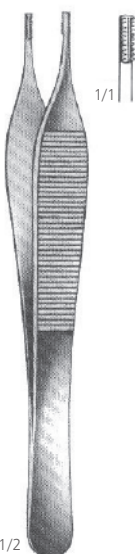

1/2
Adson - Brown
06-280-12 ■
12 cm



1/2
Adson - Brown
06-281-12 ■
12 cm

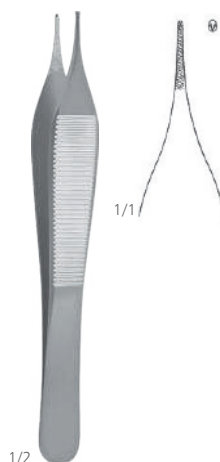

1/2
Mini - Adson
06-284-12 ■
12 cm
1:2 Teeth

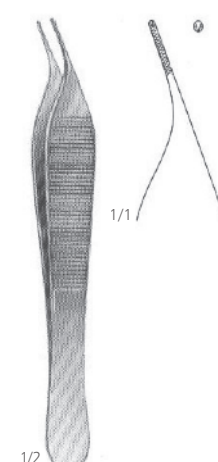

1/2
Mini - Adson
06-285-12 ■
12 cm
1:2 Teeth

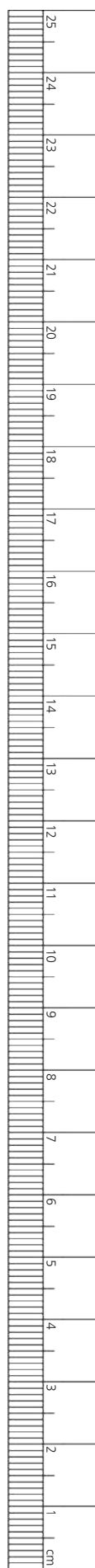

Forceps - Zange - Fórceps - Pincas

06

Tissue Forceps
 Chirurgische Pinzetten
 Pinzas de disección con diente
 Pincas à dissection à griffes



Ewald (Hudson)
 06-290-12 II
 12 cm
 1:2 Teeth



Adlerkreuz
 06-294-15 - 06-296-25



06-294-15 II
 15 cm
 2:3 Teeth



06-294-20 II
 20 cm
 2:3 Teeth



06-296-15 II
 15 cm
 4:5 Teeth



06-296-20 II
 20 cm
 4:5 Teeth



06-296-25 II
 25 cm
 4:5 Teeth



Stille
 06-300-15 II
 15 cm
 1:2 Teeth



Stille
 06-302-15 II
 15 cm
 2:3 Teeth

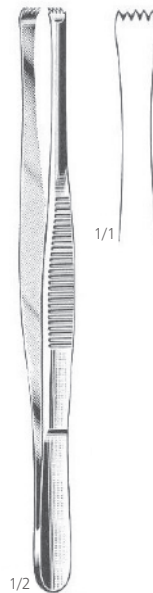

Stone
 06-304-15 II
 15 cm
 4:5 Teeth

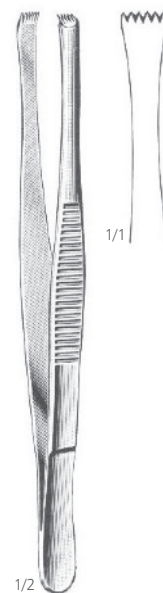

Lerche
 06-308-15 II
 15 cm
 5:6 Teeth

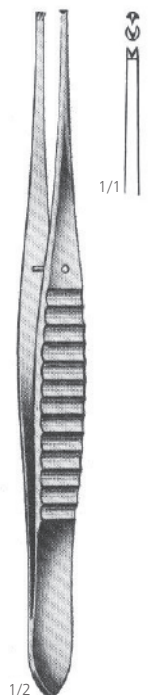

Gillies
06-320-15 15 cm 1:2 Teeth

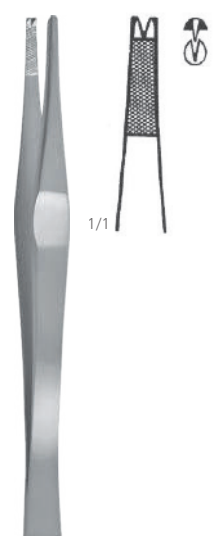

Lane
06-324-14 14.5 cm 1:2 Teeth
06-324-20 20.0 cm 1:2 Teeth

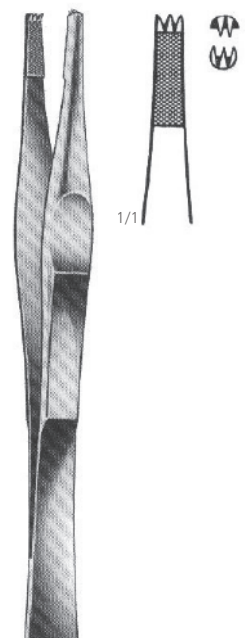

Lane
06-326-14 14.5 cm 2:3 Teeth
06-326-20 20.0 cm 2:3 Teeth

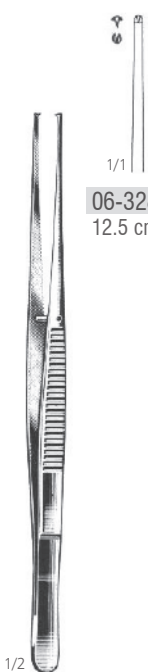

Semken
06-328-12 - 06-329-15 12.5 cm 15 cm 1:2 Teeth

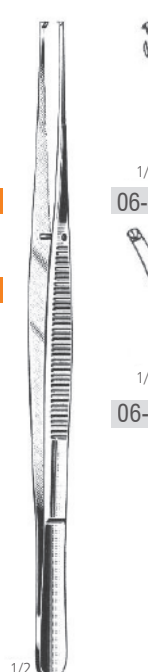

Taylor
06-332-17 - 06-333-17 12.5 cm 15 cm 17:5 Teeth



Taylor
06-336-17 17.5 cm 1:2 Teeth



Taylor
06-337-17 17.5 cm 1:2 Teeth

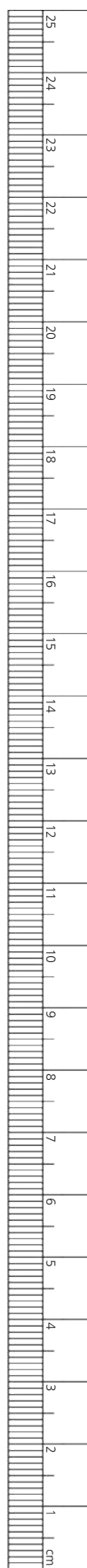

Forceps - Zange - Fórceps - Pincas

06

Tissue Forceps
 Chirurgische Pinzetten
 Pinzas de disección con diente
 Pincas à dissection à griffes

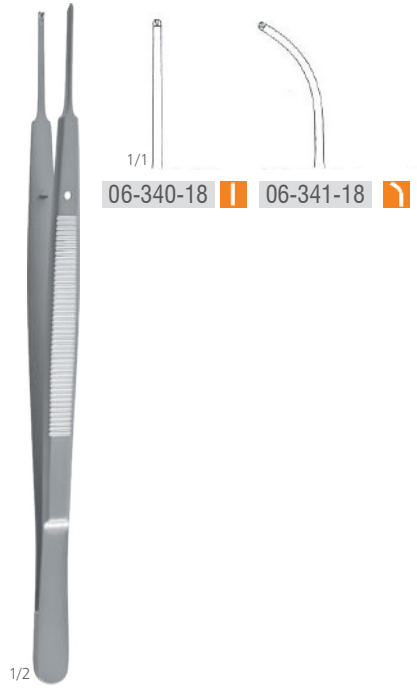

Gerald
 06-340-18 - 06-341-18
 18 cm
 1:2 Teeth

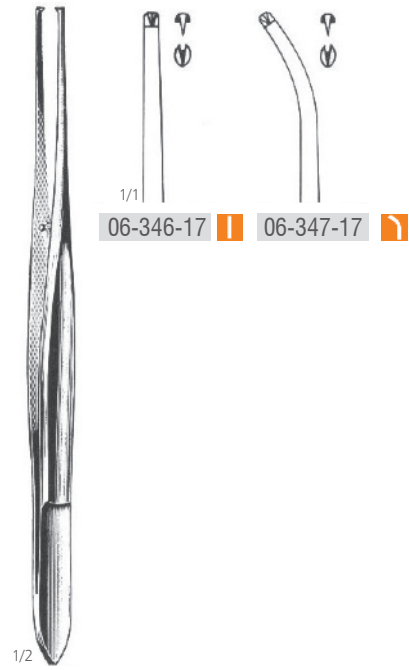

Cushing
 06-346-17 - 06-347-17
 17.5 cm
 1:2 Teeth

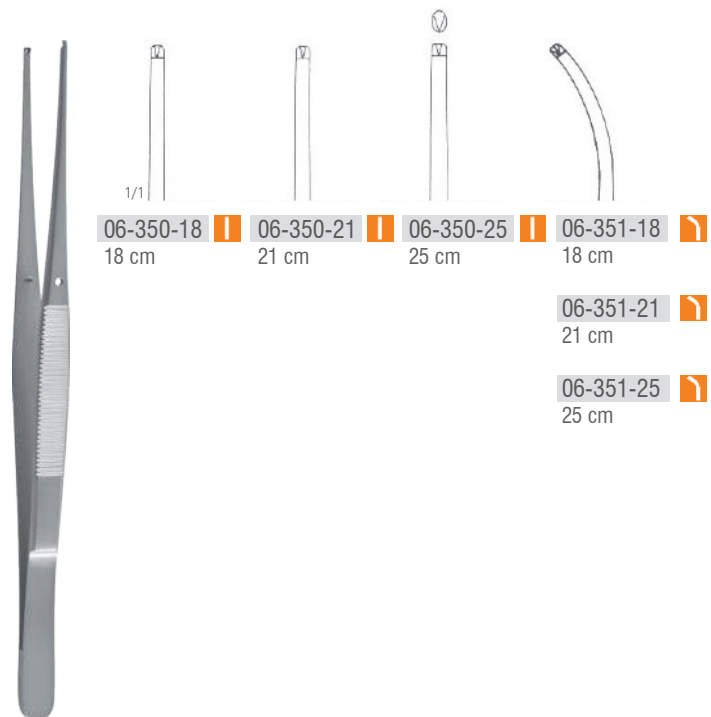

Potts - Smith
 06-350-18 - 06-351-25
 1:2 Teeth



Brophy
 06-356-20 - 06-357-20
 20 cm
 1:2 Teeth



06-370-06

06-370-08

06-370-10

06-370-06 - 06-370-10
15.5 cm
1:2 Teeth



Brown

06-374-15 15 cm
06-374-20 20 cm
06-374-25 25 cm

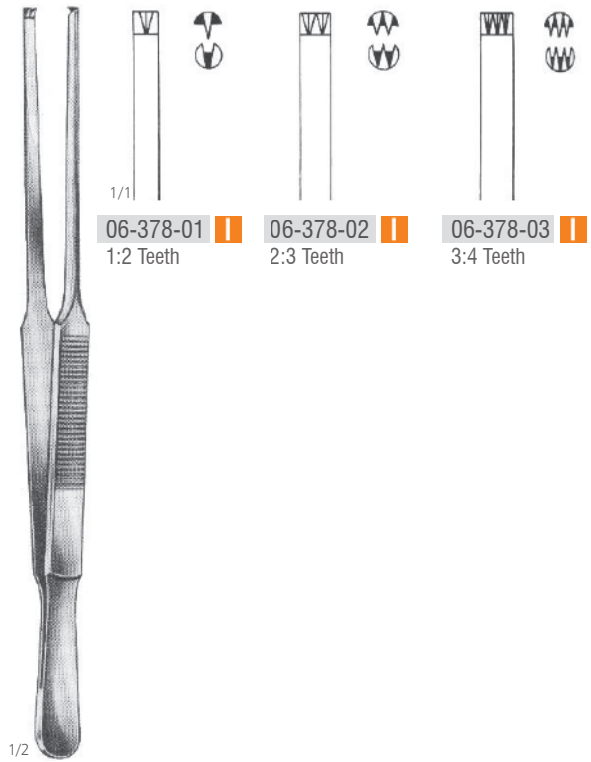

06-378-01
1:2 Teeth

06-378-02
2:3 Teeth

06-378-03
3:4 Teeth

Duehrssen
06-378-01 - 09-378-03
20 cm

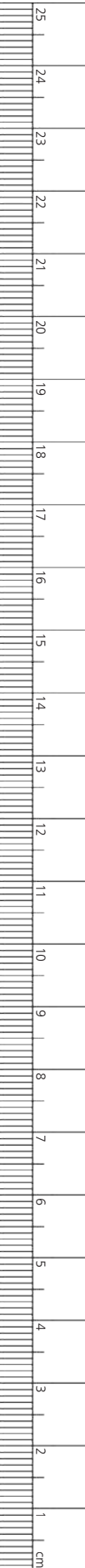

Forceps - Zange - Fórceps - Pincas

06

Tissue Forceps
 Chirurgische Pinzetten
 Pinzas de disección con diente
 Pincas à dissection à griffes



06-400-18



06-404-18
 1:2 Teeth

06-406-18
 2:3 Teeth

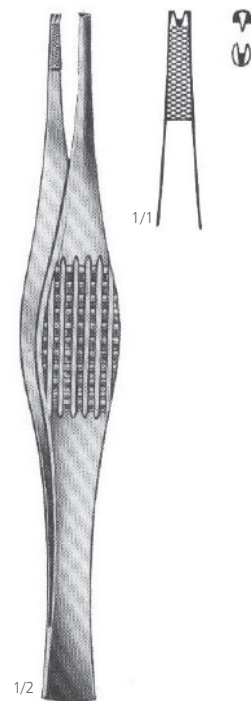

Ferris - Smith
 06-410-18
 18 cm
 1:2 cm

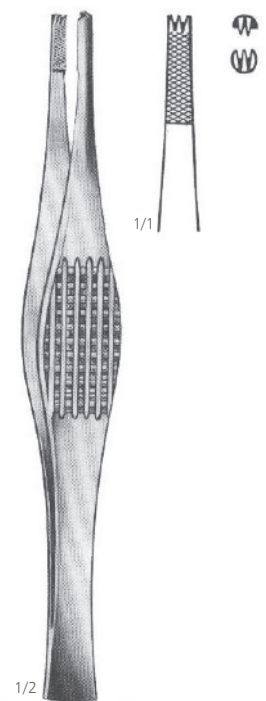

Ferris - Smith
 06-412-18
 18 cm
 2:3 cm

Stille - Barraya
 06-400-18 18 cm
 06-400-20 20 cm
 06-400-25 25 cm
 3:4 Teeth

Bonney
 06-404-18 - 06-406-18
 18 cm

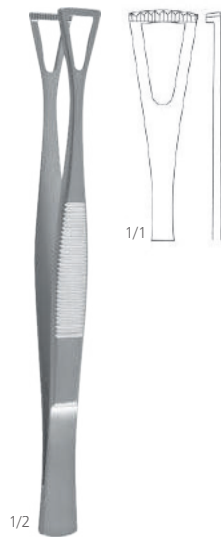
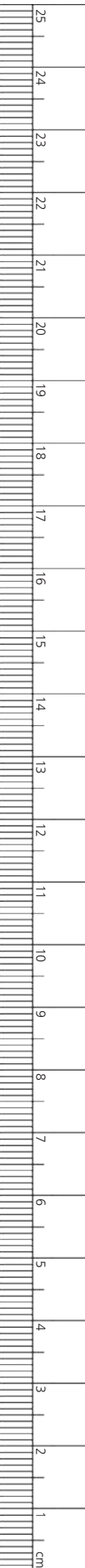

Duval
 06-420-14 
 14.5 cm



Russ. Modell
 06-426-15 - 06-426-25



06-426-15 
 15 cm



06-426-20 
 20 cm



06-426-25 
 25 cm

Forceps - Zange - Fórceps - Pincas

06

Grasping Forceps
 Faßpinzetten
 Pinzas para coger
 Pincas à préhension

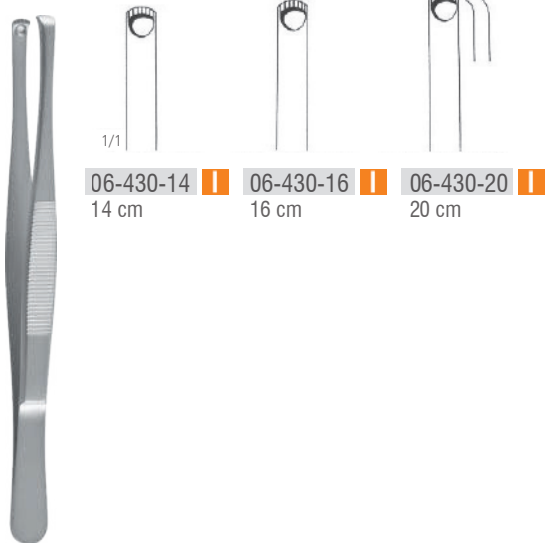

Durante
 06-430-14 - 06-430-20

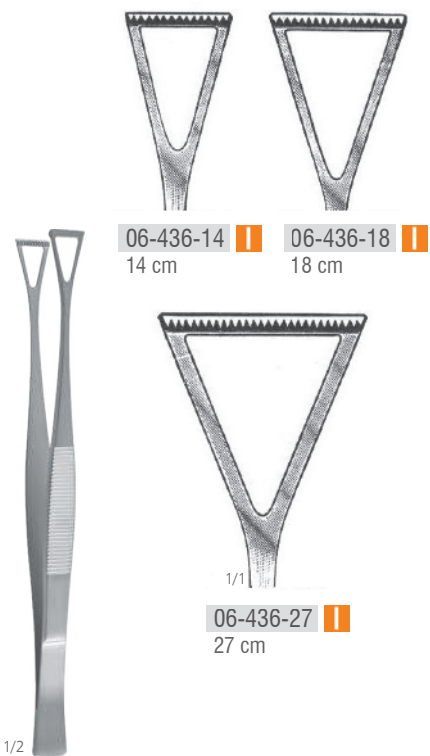

Collin - Duval
 06-436-14 - 06-436-27
 20 cm



Mayo - Russ.
 06-440-23 
 23 cm



Singley - Tuttle
 06-444-23 
 23 cm



Nelson
 06-448-23 
 23 cm

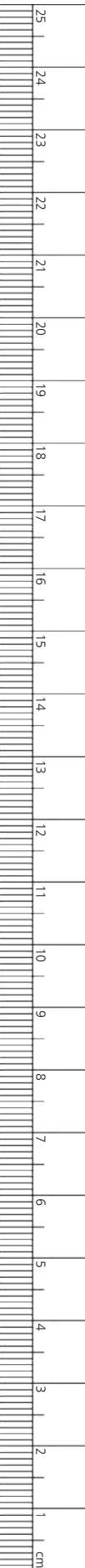

Forceps - Zange - Fórceps - Pincas

06

Jeweler's Forceps
Uhrmacherpinzetten
Pinzas de relojero
Pincas de bijoutier



06-460-01 11.5 cm



06-460-02 11 cm



06-460-03 11 cm



06-460-04 11.5 cm



06-460-05 10.5 cm

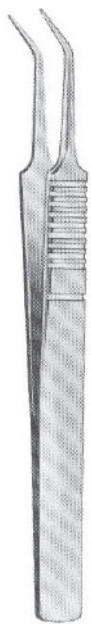

06-460-06 10.5 cm



06-460-07 11.5 cm

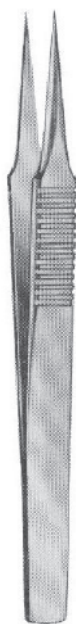

06-460-08 11.5 cm



06-460-09 11.5 cm

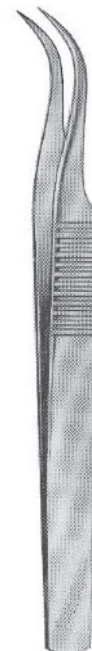

06-460-10 10.5 cm

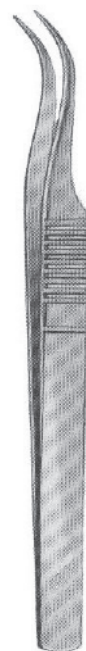

06-460-11 10.5 cm



06-460-12 
12.5 cm



06-460-13 
12.5 cm



06-460-14 
12.5 cm



06-462-01 
10 cm



06-462-02 
10 cm



06-462-03 
10 cm



06-466-01 
14 cm

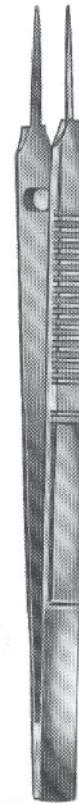

06-466-02 
14 cm

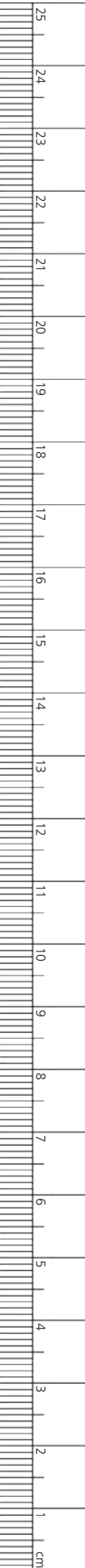

Forceps - Zange - Fórceps - Pincas

06

Tumor Forceps
 Tumorzangen
 Pinças para tumores
 Pince à tumeur





1/2

Graefe
06-502-10 - 06-515-10
10.5 cm

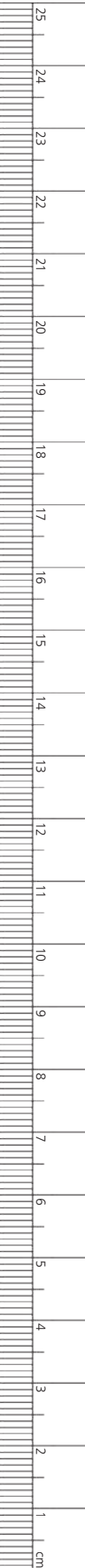
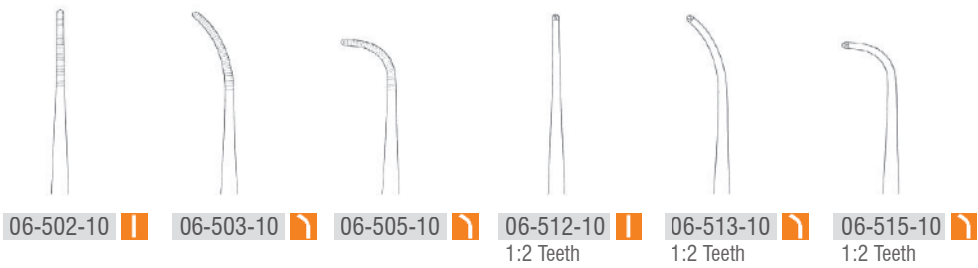

Forceps - Zange - Fórceps - Pincas

06

Forceps, fine patterns
 Pinzetten, feine Modelle
 Pinzas, modelos finos
 Pincas, motivos fins

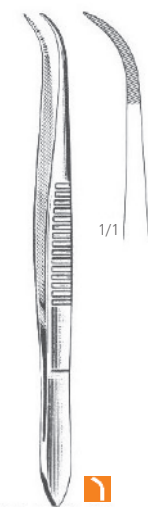
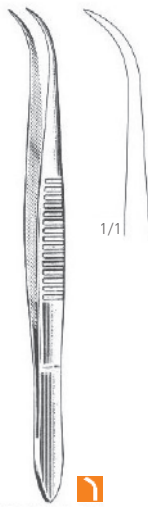

8.0 cm	06-520-08	06-521-08	06-524-08	06-525-08
9.0 cm	06-520-09	06-521-09	06-524-09	06-525-09
10.5 cm	06-520-10	06-521-10	06-524-10	06-525-10
11.5 cm	06-520-11	06-521-11	06-524-11	06-525-11
12.5 cm	06-520-12	06-521-12	06-524-12	06-525-12
14.5 cm	06-520-14	06-521-14	06-524-14	06-525-14

without pin without pin without pin without pin

8.0 cm	06-530-08	06-531-08	06-534-08	06-535-08
9.0 cm	06-530-09	06-531-09	06-534-09	06-535-09
10.5 cm	06-530-10	06-531-10	06-534-10	06-535-10
11.5 cm	06-530-11	06-531-11	06-534-11	06-535-11
12.5 cm	06-530-12	06-531-12	06-534-12	06-535-12
14.5 cm	06-530-14	06-531-14	06-534-14	06-535-14

with pin with pin with pin with pin

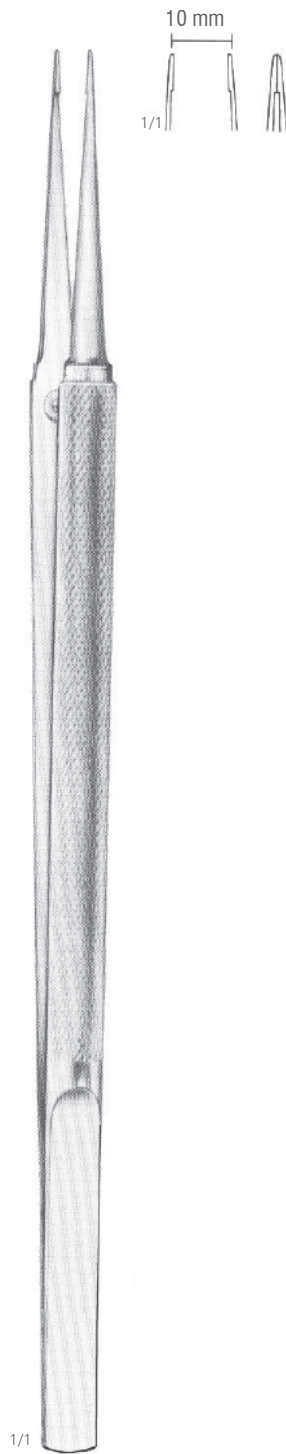

Gomel
06-540-01 
16 cm

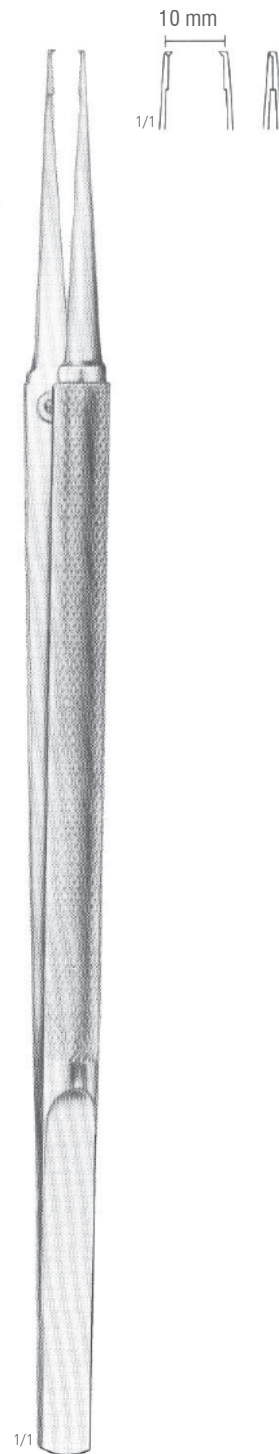

Gomel
06-540-06 
16 cm
1:2 Teeth

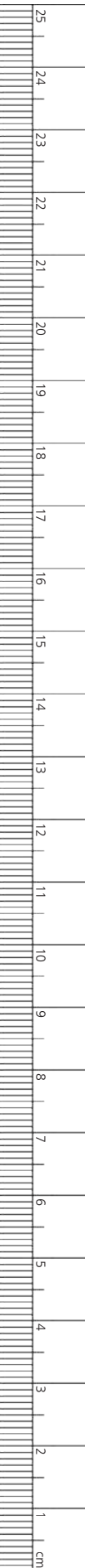

Forceps - Zange - Fórceps - Pincas

06

Micro Forceps
Mikro - Pinzatten
Micro - pinzas
Micro-pincas

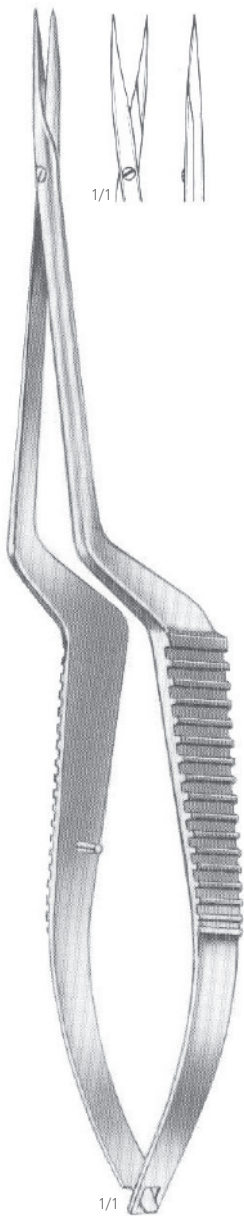

06-550-15
15.5 cm

Knotting forceps



06-553-01 - 06-553-03
18.5 cm

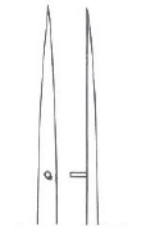

06-553-01
sharp

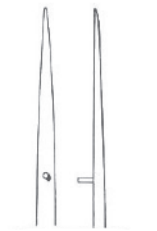

06-553-02
blunt

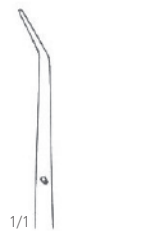

06-553-03
angled

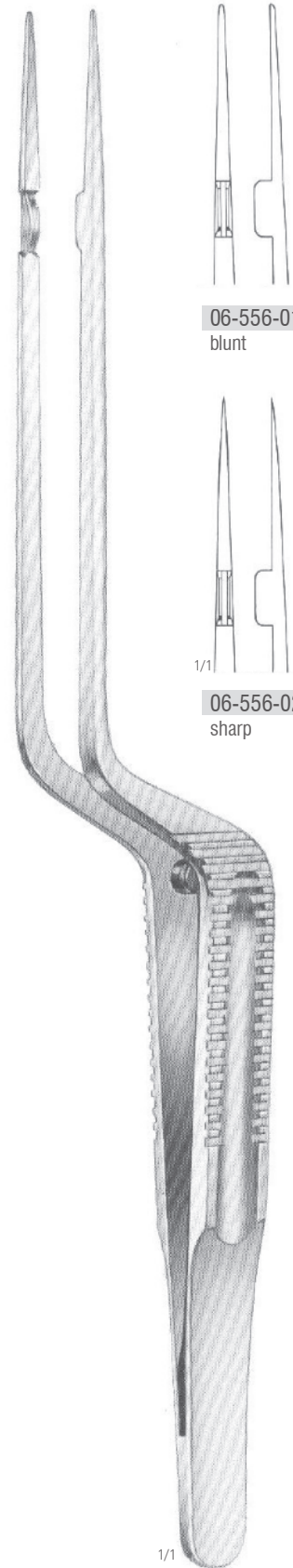

06-556-01
blunt

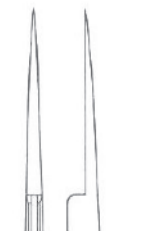

06-556-02
sharp

06-556-01 - 06-556-02
22.5 cm

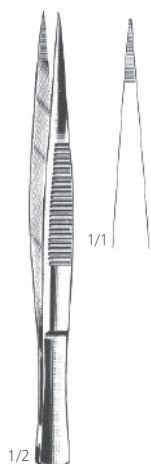

06-570-12
 12.5 cm



06-574-10
 10 cm



06-576-10
 10 cm



Feilchenfeld
 06-578-07 - 06-578-11

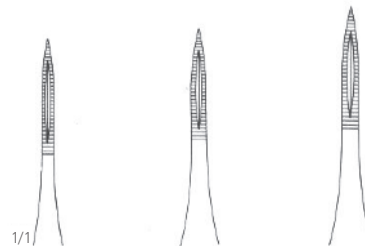

06-578-07 7.5 cm
 06-578-09 9 cm
 06-578-11 11.5 cm



Hunter
 06-580-10 - 06-581-10
 10.5 cm

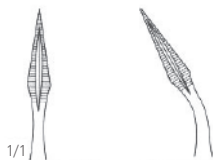

06-580-10 06-581-10



Walter - Carmalt
 06-584-10
 10.5 cm



Walter - Carmalt
 06-585-10
 10.5 cm



06-588-10
 10.5 cm

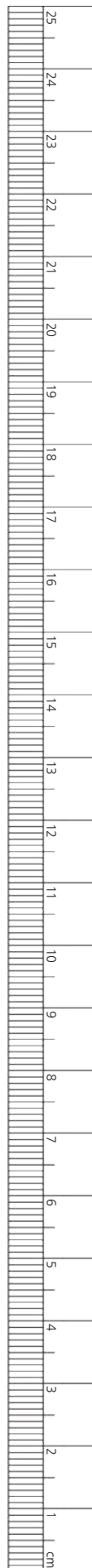

Forceps - Zange - Fórceps - Pincas

06

Cilia Forceps
Cilienpinzetten
Pinzas depilatorias
Pince à cils



Douglas
06-590-09 
9 cm

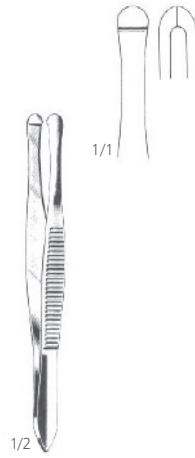

Beer
06-594-09 
9 cm



Barraquer
06-597-10 
10.5 cm



Shaaf
06-601-09 
9 cm



Littauer
06-604-08 
8.5 cm



06-606-09 
9 cm



Douglas
06-608-09 
9 cm

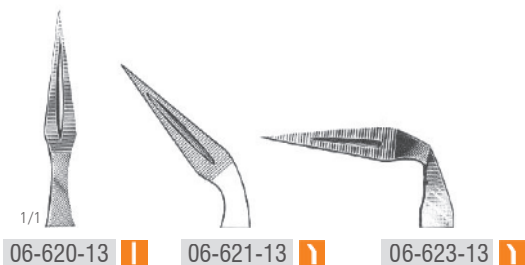
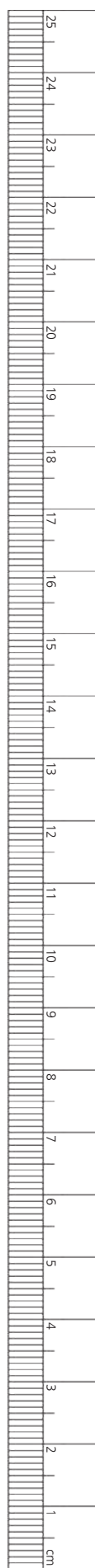

Stieglitz
06-620-13 - 06-623-13
13.5 cm

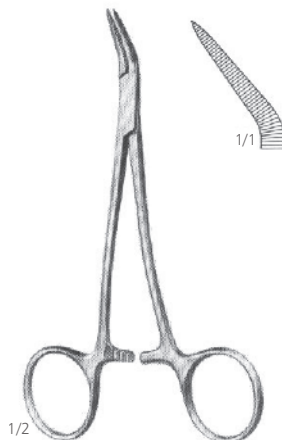

Peet
06-625-11
11.5 cm

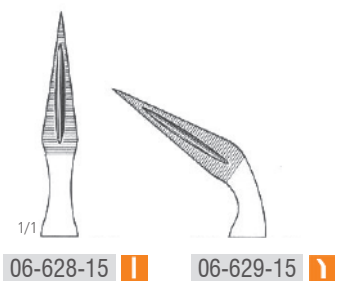

Ralk
06-628-15 - 06-629-15
15 cm



Arthur
06-632-14
14 cm

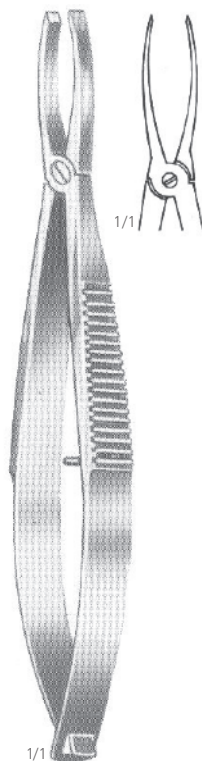

Gradle
06-635-09
9.5 cm

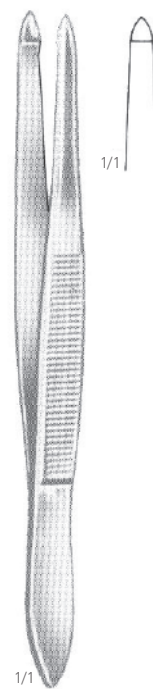

Ziegler
06-638-09
9 cm

Forceps - Zange - Fórceps - Pincas

06

Non - traumatic Vascular Tissue Forceps
 Nicht-traumatische Gefäß-Gewebepinzette
 Fórceps de tejido vascular atraumático
 Pincas à tissus vasculaires non traumatiques

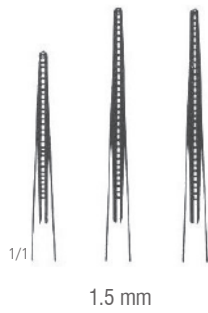

1.5 mm



2.0 mm



2.8 mm

De Bakey

06-650-16	16 cm	
06-650-20	20 cm	
06-650-24	24 cm	



De Bakey

06-652-16	16 cm	
06-652-20	20 cm	
06-652-24	24 cm	
06-652-30	30 cm	





De Bakey

06-654-16	16 cm	
06-654-20	20 cm	
06-654-24	24 cm	
06-654-30	30 cm	

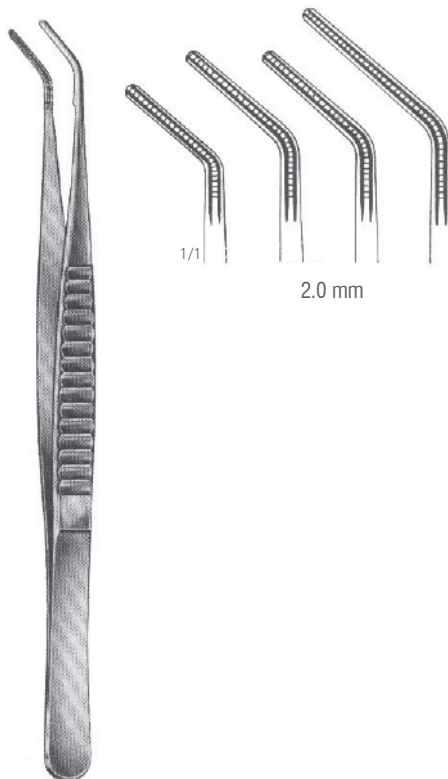

De Bakley		
06-556-20	20 cm	
06-556-24	24 cm	
06-556-30	30 cm	



De Bakley		
06-559-16	16 cm	
06-559-20	20 cm	
06-559-24	24 cm	
06-559-30	30 cm	

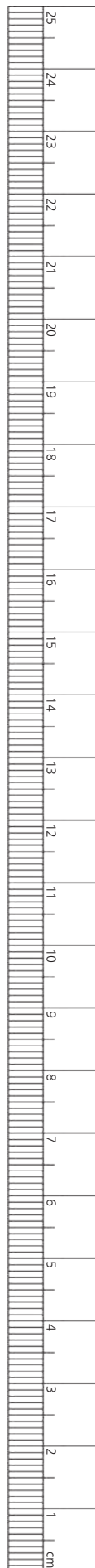



Gassman	
06-670-15	15 cm
06-670-24	24 cm

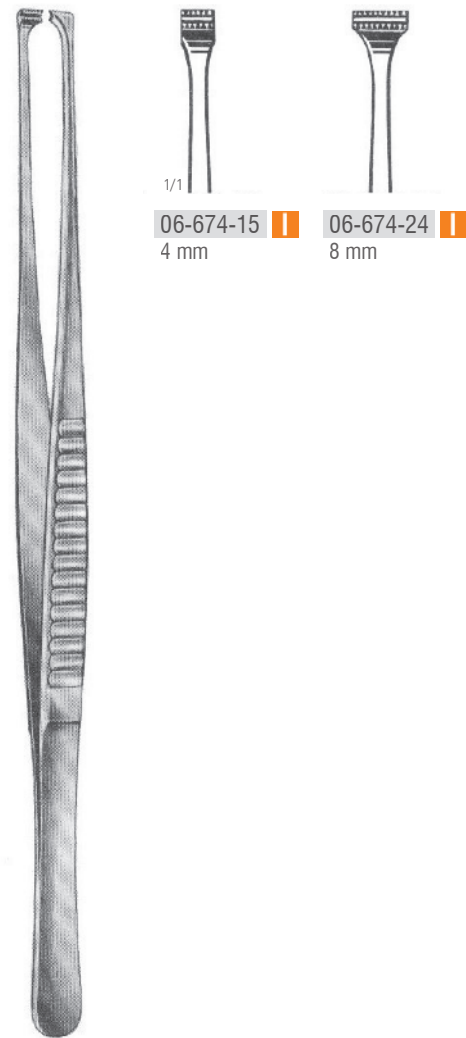

Gassman	
06-674-15	15 cm
06-674-24	24 cm



Engl. Modell		
06-680-12	12.5 cm	II
06-680-15	15.0 cm	II
06-680-18	18.0 cm	II
06-680-20	20.0 cm	II



Engl. Modell		
06-682-12	12.5 cm	II
06-682-15	15.0 cm	II
06-682-18	18.0 cm	II
06-682-20	20.0 cm	II
06-682-25	25.0 cm	II
06-682-30	30.0 cm	II



Treves		
06-688-12	12.5 cm	II
06-688-15	15.0 cm	II
06-688-18	18.0 cm	II
06-688-20	20.0 cm	II

1:2 Teeth

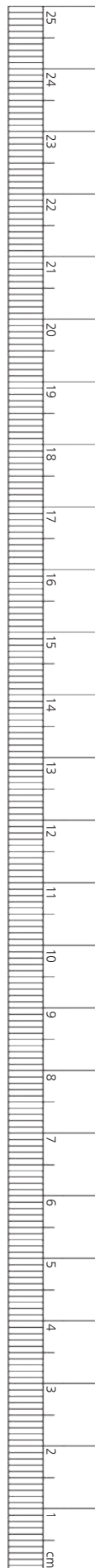

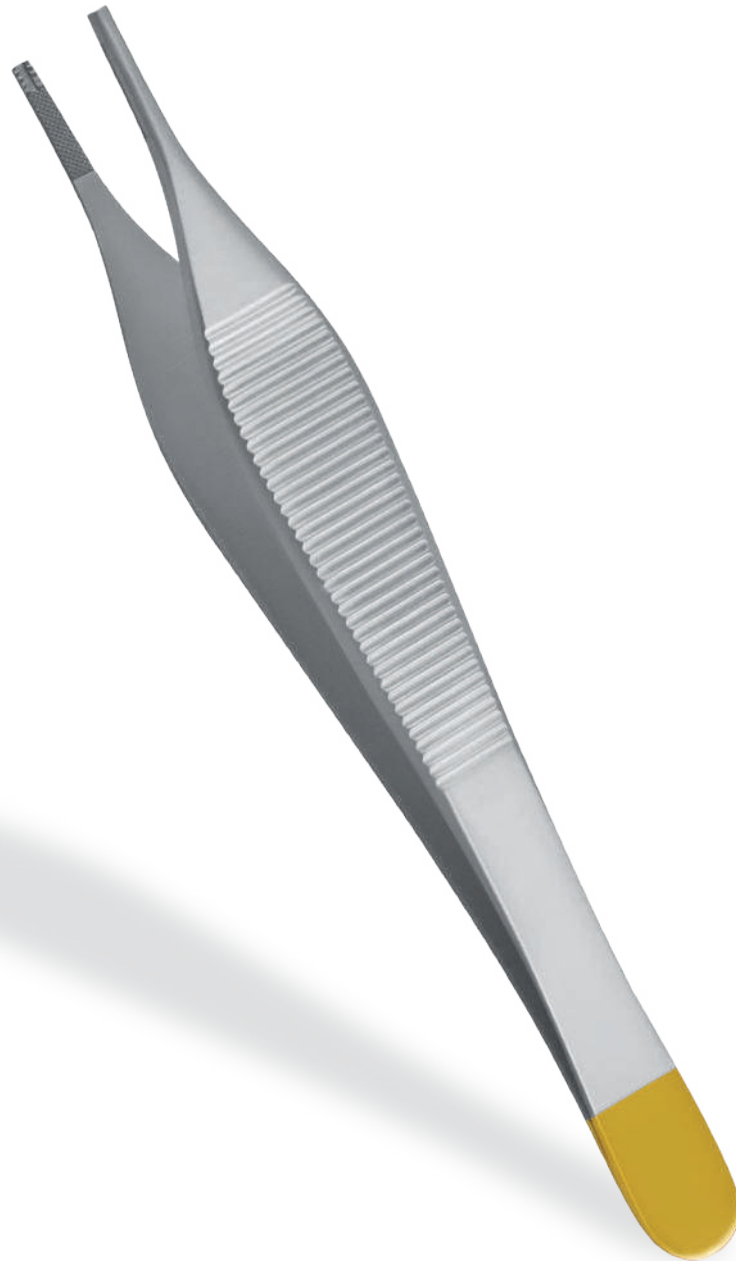

tc gold

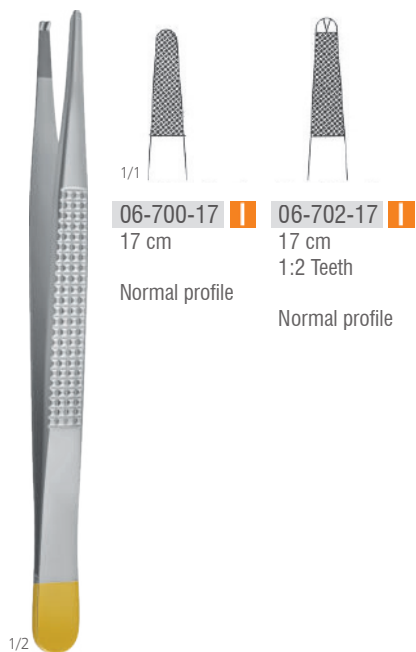

06-700-17 17 cm Normal profile
 06-702-17 17 cm 1:2 Teeth Normal profile

Bonney
 06-700-17 - 06-702-17

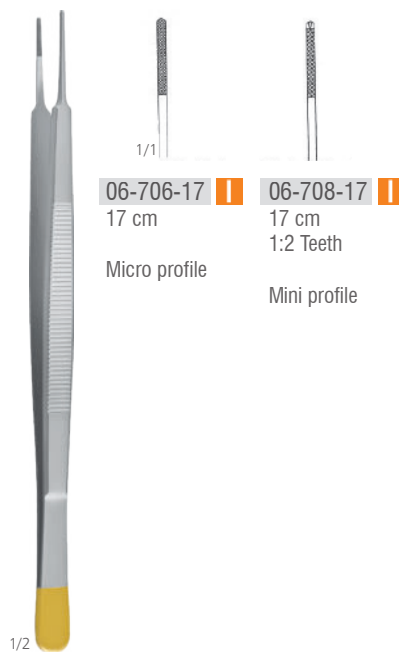

06-706-17 17 cm Micro profile
 06-708-17 17 cm 1:2 Teeth Mini profile

Gerald
 06-706-17 - 06-708-17

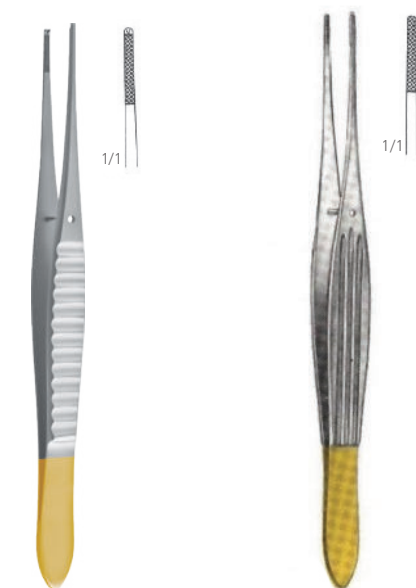

06-710-15 15 cm 1: 2 teeth Mini Profile
 06-712-15 15 cm Mini Profile

Gillies

McIndoe



06-716-16 16 cm 1:2 teeth Normal profile
 06-716-18 18 cm 1:2 teeth Normal profile
 06-718-16 16 cm 1:2 teeth Mini profile
 06-718-18 18 cm 1:2 teeth Mini profile

Semken
 06-716-16 - 06-718-18

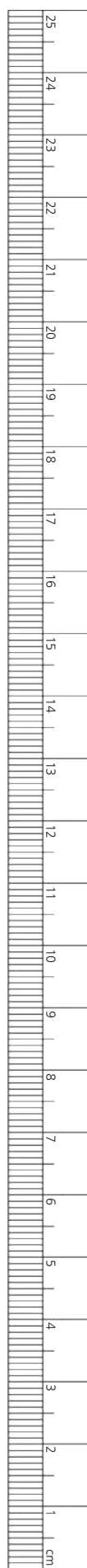

Forceps - Zange - Fórceps - Pincas

06

Dissecting Forceps with Tungsten Carbide Inserts

Pinzetten mit Hartmetalleinsätzen

Pinzas de diseccion con bocas de carburo de tungsteno

Pince à dissection avec inserts en carbure de tungstène

tc gold



Adson - Brown
06-720-12 II
12 cm

Normal Profile



Micro - Adson
06-722-12 - 06-722-15

Mini Profile

06-722-12 II
12 cm
1:2 Teeth

06-722-15 II
15 cm
1:2 Teeth



Adson
06-726-12 - 06-728-15

Normal Profile

06-726-12 II
12 cm

06-728-12 II
12 cm
1:2 Teeth

06-726-15 II
15 cm

06-728-15 II
15 cm
1:2 Teeth



Cushing
06-732-17 II
17.5 cm

Normal Profile

with dissector end



Cushing
06-733-17 II
17.5 cm

Normal Profile

with dissector end



Cushing - Taylor
06-736-18 II
18 cm

Normal Profile

tc gold



Potts - Smith
 06-740-15 - 06-740-25

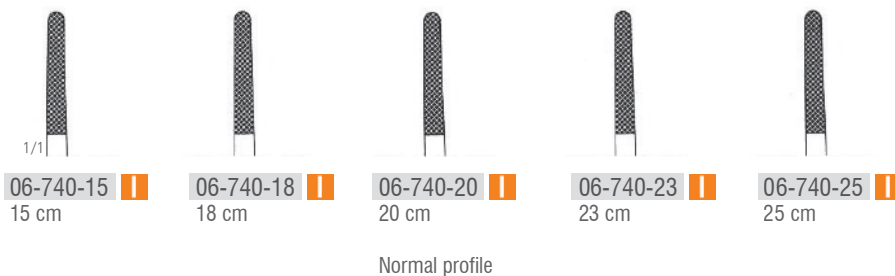

Oehler
 06-742-14 - 06-742-30

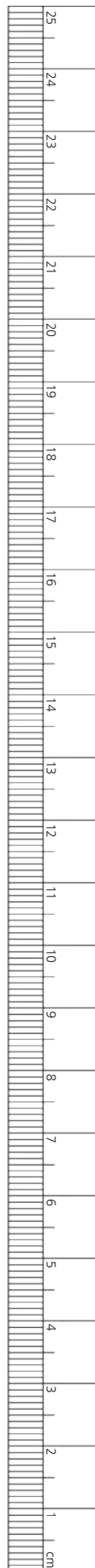
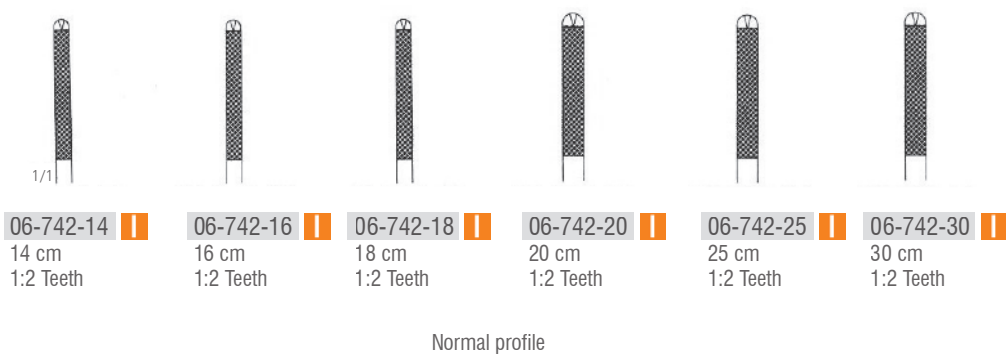

Forceps - Zange - Fórceps - Pincas

Dissecting Forceps with Tungsten Carbide Inserts

Pinzetten mit Hartmetalleinsätzen

Pinzas de disección con bocas de carburo de tungsteno

Pince à dissection avec inserts en carbure de tungstène

06

tc gold

Knotting forceps



Obwegeser
06-750-16 II
16 cm



Obwegeser
06-750-18 II
18 cm



Wangensteen
06-756-15 - 06-756-25

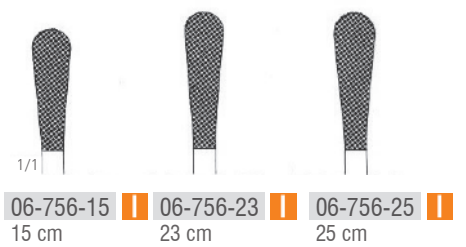

Normal profile

tc gold

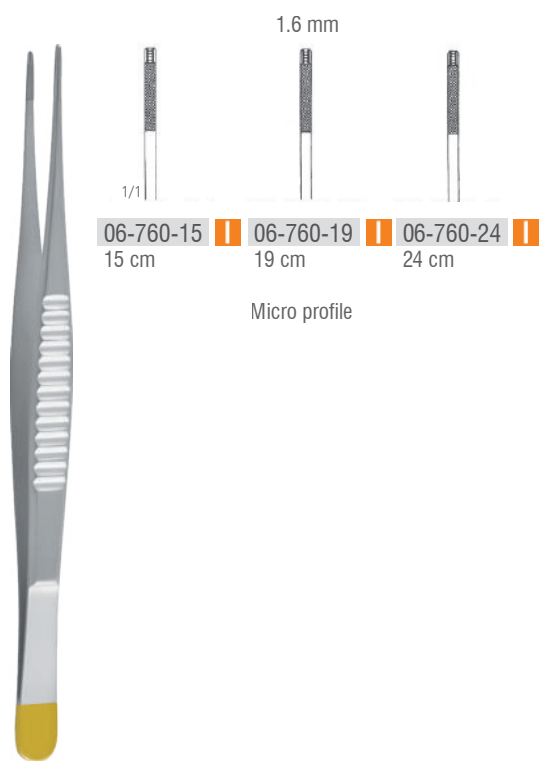
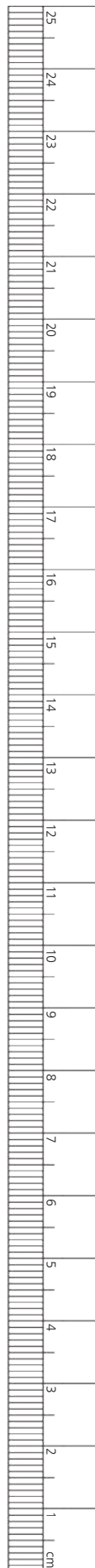

De Bakley
 06-760-15 - 06-760-24

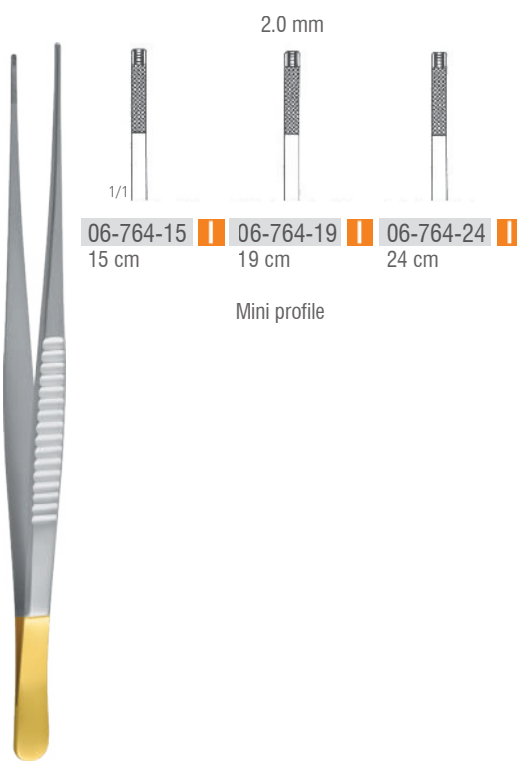

De Bakley
 06-764-15 - 06-764-24



JABOMA-TC
06-770-18 
18 cm



JABOMA-TC
06-776-18 
18 cm
1:2 Teeth

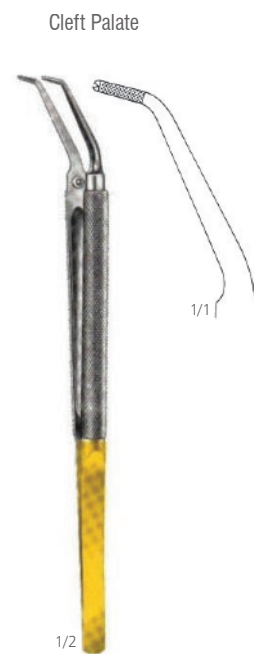

JABOMA-TC
06-777-18 
18 cm
1:2 Teeth

07

Forceps
Zange
Fórceps
Forceps



Forceps - Zange - Fórceps - Forceps

07

Mini Vascular Clamps
 Mini-Gefäßklemmen
 Mini pinzas vasculares
 Mini pinces vasculaires

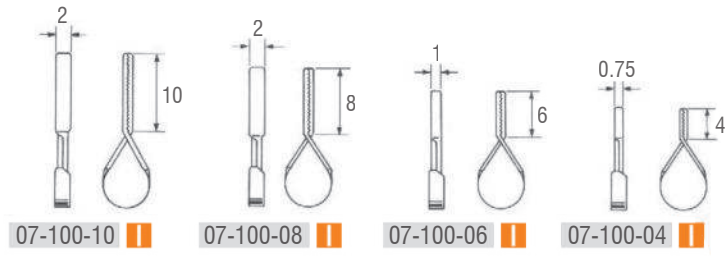

07-100-10 ■ ■ 07-100-08 ■ ■ 07-100-06 ■ ■ 07-100-04 ■ ■

1/1

Length of Jaw 10 mm
 Width of Jaw 2 mm

07-100-10 ■ ■

1/1

Length of Jaw 18 mm
 Width of Jaw 2 mm

07-100-08 ■ ■

1/1

Length of Jaw 16 mm
 Width of Jaw 1 mm

07-100-06 ■ ■

1/1

Length of Jaw 14 mm
 Width of Jaw 0.75 mm

07-100-04 ■ ■

1/2

07-102-14 ■ ■
 14 cm

1/2

07-104-18 ■ ■
 18 cm

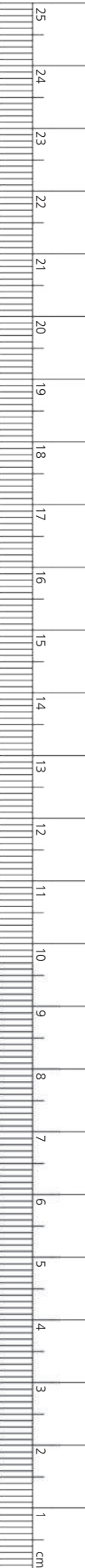

07-108-10 - 07-109-18

	07-108-10	07-108-14	07-108-18	07-109-10	07-109-14	07-109-18
Length	31 mm	35 mm	39 mm	30 mm	33 mm	36 mm
Jaws	10 mm	10 mm	10 mm	10 mm	10 mm	10 mm

Forceps - Zange - Fórceps - Forceps







07

Bulldog Clamps
 Bulldoggenklammern
 Pinzas Bulldog
 Pincas Bulldog







1/1





Dieffenbach

- | | | | | | |
|--|---|---|---|---|---|
| 
1/1 |  |  |  |  |  |
| 07-110-03 ■■
3.5 cm | 07-110-02 ■■
5 cm | 07-110-06 ■■
6 cm | 07-111-03 ■■
3.5 cm | 07-111-02 ■■
5 cm | 07-111-06 ■■
6 cm |



1/1
 Johns Hopkins





- | | | | | |
|--|---|---|---|--|
| 
1/1 |  |  |  |  |
| 07-114-04 ■■
4 cm | 07-114-05 ■■
5 cm | 07-114-06 ■■
6.5 cm | 07-114-07 ■■
7.5 cm | 07-114-09 ■■
9 cm |

- | | | | | |
|--|---|---|--|---|
| 
1/1 |  |  |  |  |
| 07-115-04 ■■
4 cm | 07-115-05 ■■
5 cm | 07-115-06 ■■
6.5 cm | 07-115-07 ■■
7.5 cm | 07-115-09 ■■
9 cm |



Diethrich
07-120-08 - 07-121-12

Length
Jaws

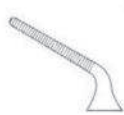
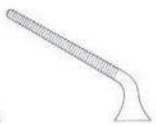





					
07-120-08	07-120-10	07-120-12	07-121-08	07-121-10	07-121-12
50 mm 8 mm	50 mm 12 mm	60 mm 20 mm	50 mm 8 mm	50 mm 12 mm	60 mm 20 mm

Atrauma



DeBakey - Diethrich
07-124-10 - 07-125-20

Length
Jaws

					
07-124-10	07-124-14	07-124-20	07-125-10	07-124-14	07-125-20
50 mm 10 mm	50 mm 14 mm	60 mm 20 mm	50 mm 10 mm	50 mm 14 mm	60 mm 20 mm

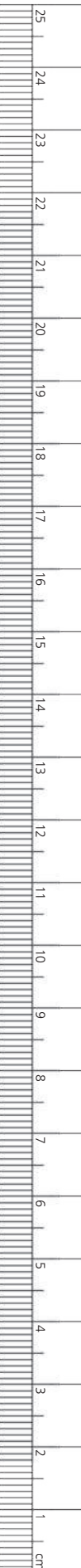

Forceps - Zange - Fórceps - Forceps

07

Atrauma Bulldog Clamps
 Atrauma - Bulldogklemmen
 Pinzas Atrauma Bulldog
 Pincas de bouledogue Atrauma



3 cm

3.5 cm

4 cm

5 cm

Vena	07-130-30	07-130-35	07-130-40	07-130-50
Arteria	07-140-30	07-140-35	07-140-40	07-140-50



3 cm

3.5 cm

4 cm

5 cm

Vena	07-131-30	07-131-35	07-131-40	07-131-50
Arteria	07-144-30	07-141-35	07-141-40	07-141-50



3 cm

3.5 cm

4 cm

5 cm

Vena	07-133-30	07-133-35	07-133-40	07-133-50
Arteria	07-143-30	07-143-35	07-143-40	07-143-50

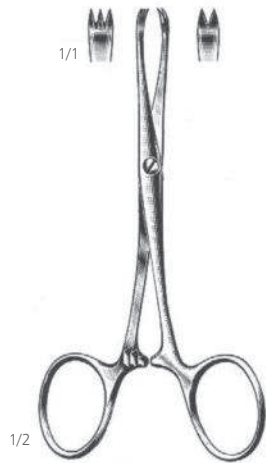

Chaput
 07-140-13 ||
 13 cm
 2:3 Teeth



Tuffier
 07-142-13 ||
 13 cm
 4:5 Teeth



Atrauma



07-146-25 ||
 25 cm

07-146-26 ||
 26 cm

07-146-25 - 07-146-26



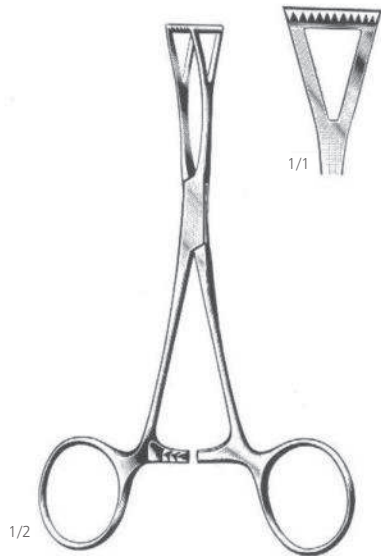

Collin
 07-150-14 II
 14 cm

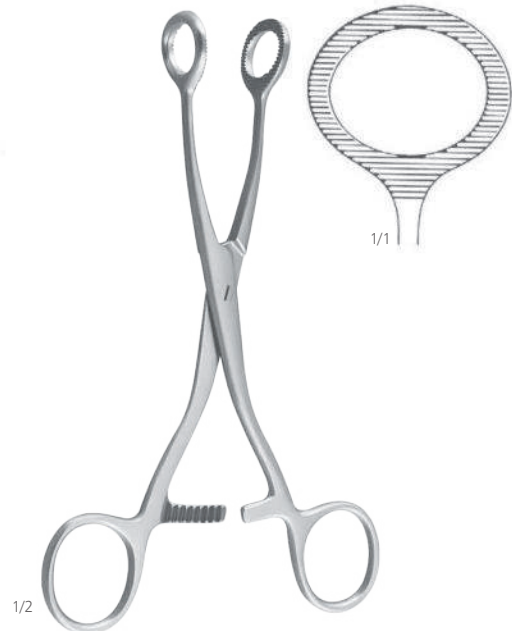

Collin
 07-152-16 II
 16.5 cm



Pennington
 07-156-15 - 07-156-20



Pratt
 07-158-15 II
 15 cm

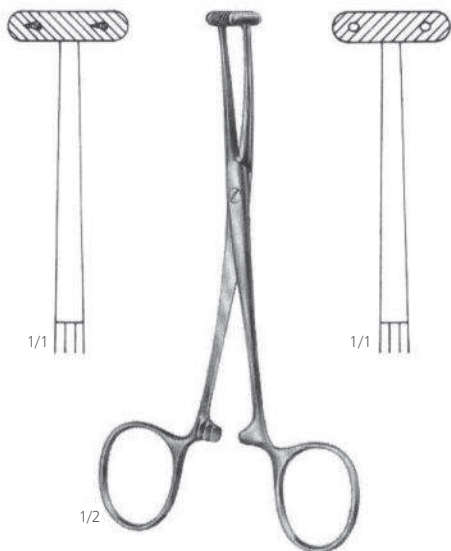

Martel - Rees
 07-160-14 ■■
 14 cm

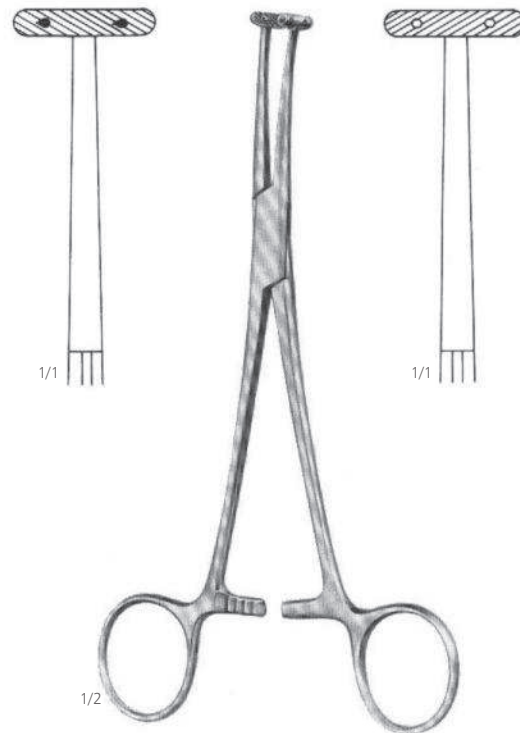

Willet - Martel
 07-160-19 ■■
 19 cm

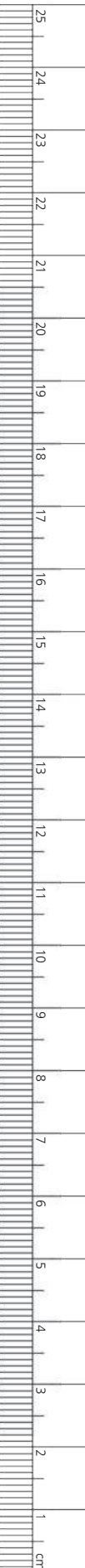



07-170-14 || 14 cm

07-170-16 || 16 cm

Pean
 07-170-14 - 07-170-16

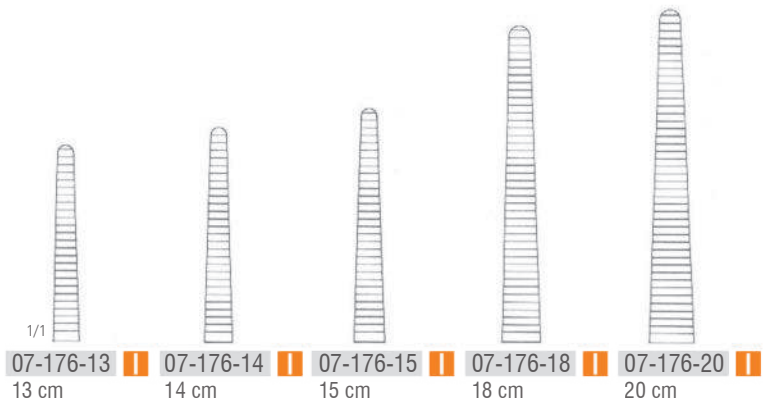

07-176-13 || 13 cm

07-176-14 || 14 cm

07-176-15 || 15 cm

07-176-18 || 18 cm

07-176-20 || 20 cm



Spencer - Wells
 07-176-13 - 07-177-20

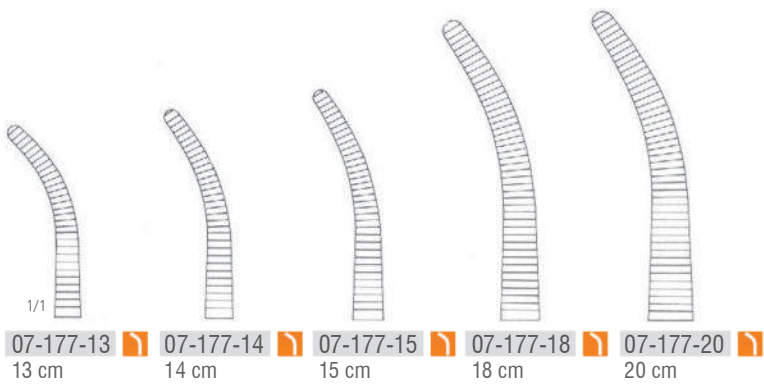

07-177-13 || 13 cm

07-177-14 || 14 cm

07-177-15 || 15 cm

07-177-18 || 18 cm

07-177-20 || 20 cm

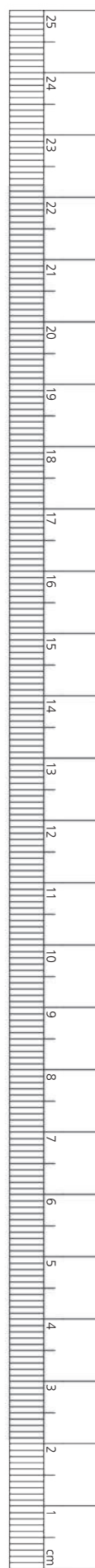

Forceps - Zange - Fórceps - Forceps

07

Artery Forceps
 Arterienklemme
 Pinzas Arteriales
 Forceps d'artère

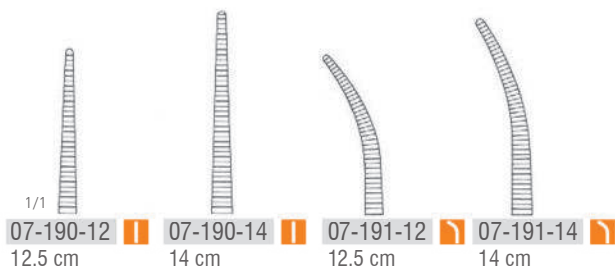

Halsted - Mosquito
 07-190-12 - 07-193-14

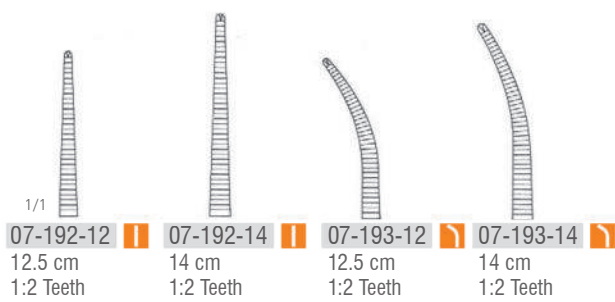



Halsted - Mosquito
07-200-18 - 07-203-21

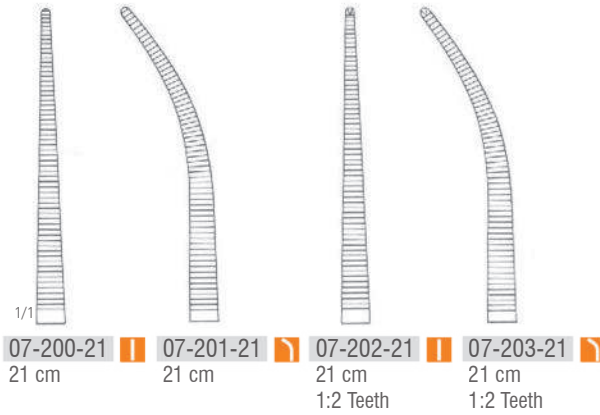
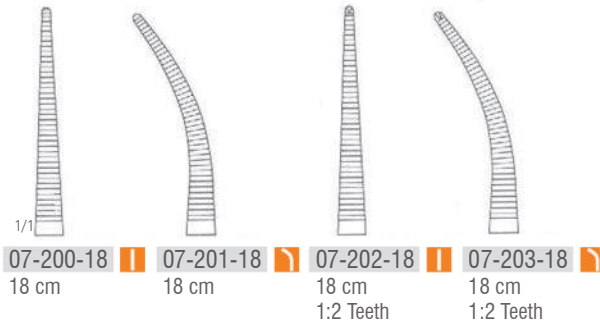

Micro - Mosquito
07-210-10 - 07-213-12

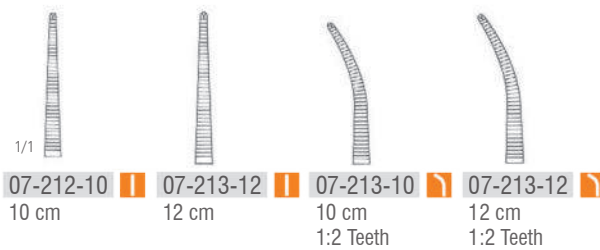
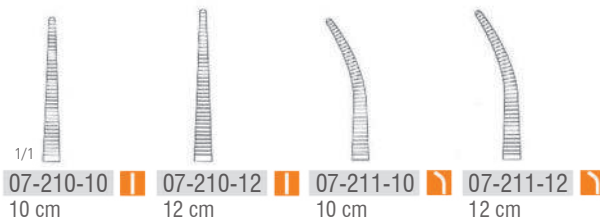

Forceps - Zange - Fórceps - Forceps

07

Artery Forceps
 Arterienklemme
 Pinzas Arteriales
 Forceps d'artère

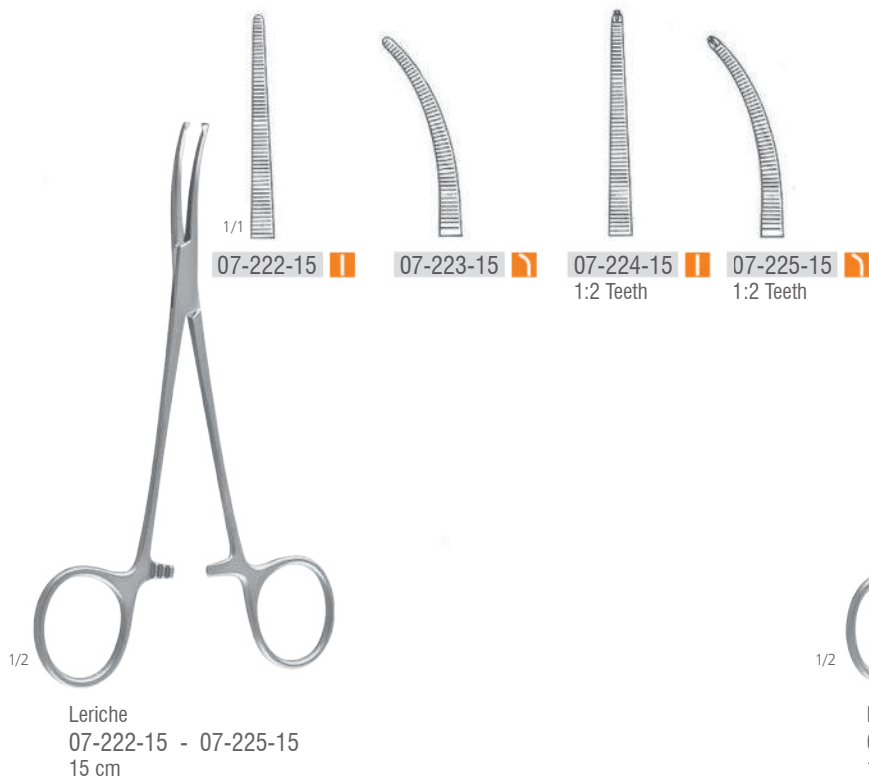



1/2

Kelly - Rankin
07-234-16 - 07-235-16
16 cm

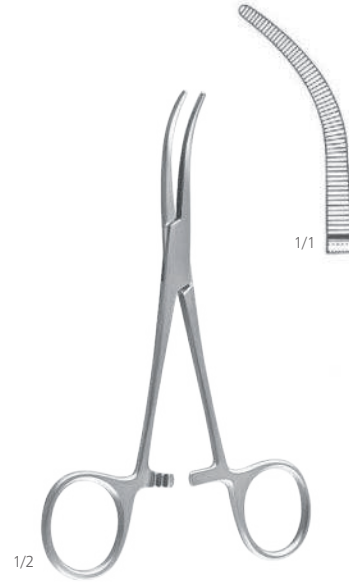
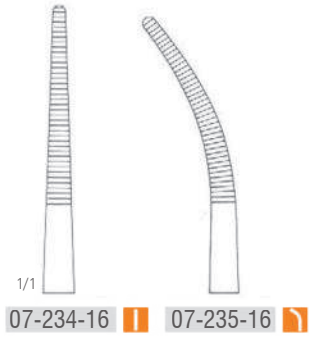

1/2

Baby - Overhalt
07-239-13
13.5 cm



1/2

Crile
07-240-14 - 07-243-14
14 cm

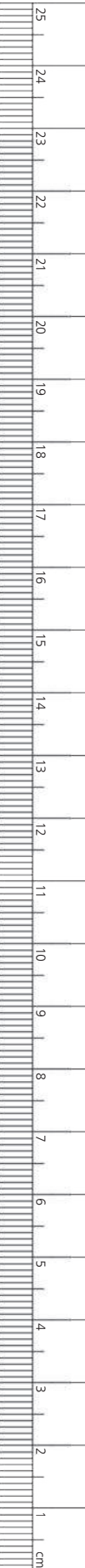
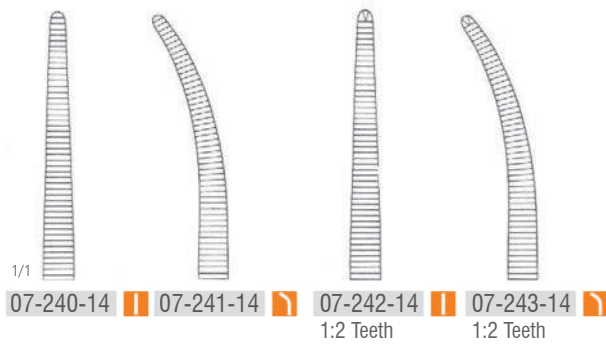

Forceps - Zange - Fórceps - Forceps

07

Artery Forceps
 Arterienklemme
 Pinzas Arteriales
 Forceps d'artère

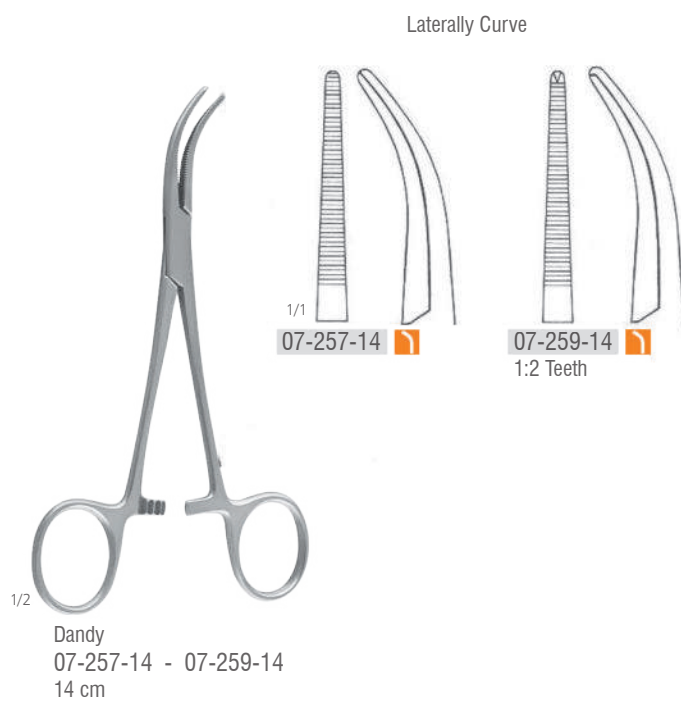
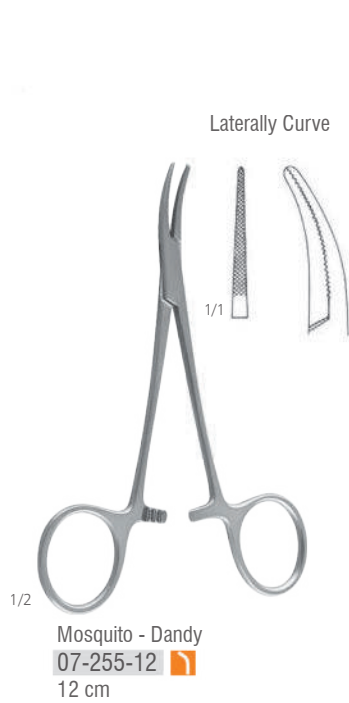
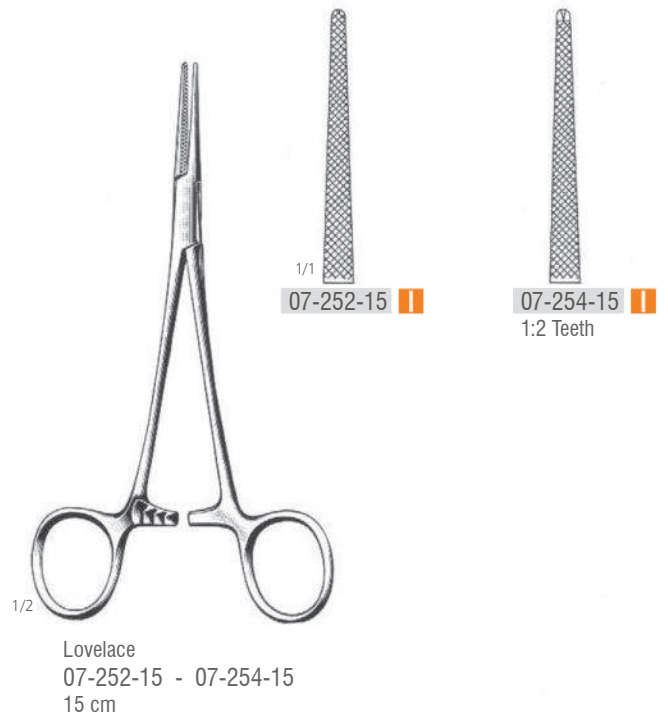
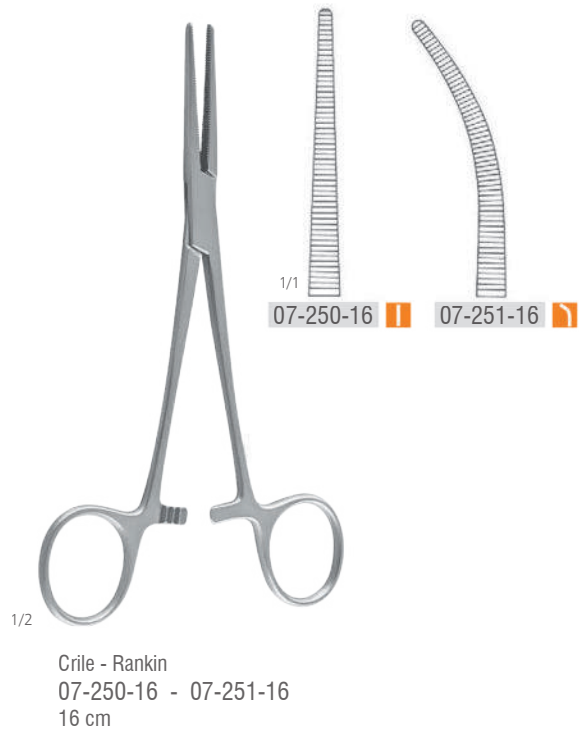



1/2

Adson
07-260-18 - 07-261-18
18.5 cm

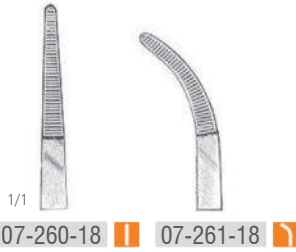

07-260-18 07-261-18



1/2

Adson
07-262-18 - 07-263-18
18.5 cm

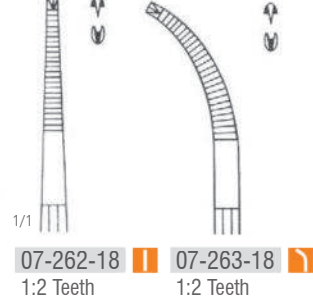

07-262-18 07-263-18
1:2 Teeth 1:2 Teeth



1/2

Rochester - Carmalt
07-266-16 - 07-267-20

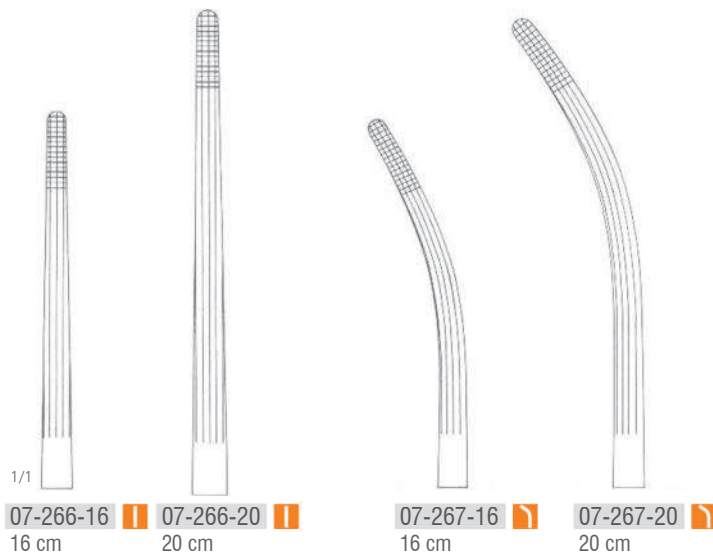

07-266-16 07-266-20 07-267-16 07-267-20
16 cm 20 cm 16 cm 20 cm

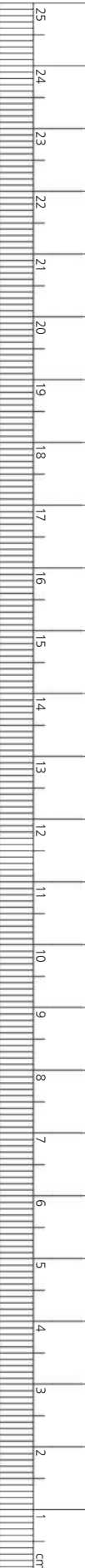

Forceps - Zange - Fórceps - Forceps

07

Artery Forceps
 Arterienklemme
 Pinzas Arteriales
 Forceps d'artère

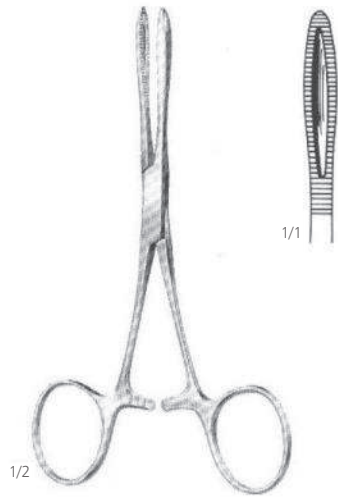

Kroenlein
 07-270-13 II
 13 cm



Carrel
 07-272-08 II
 8.5 cm

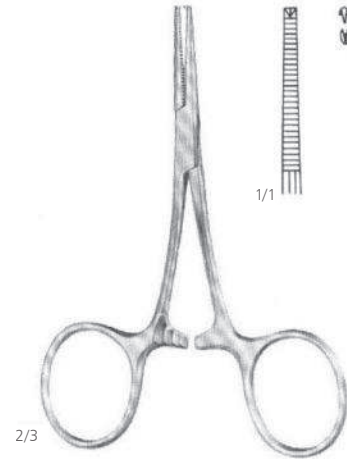

Terrier
 07-274-08 II
 8.5 cm
 1:2 Teeth

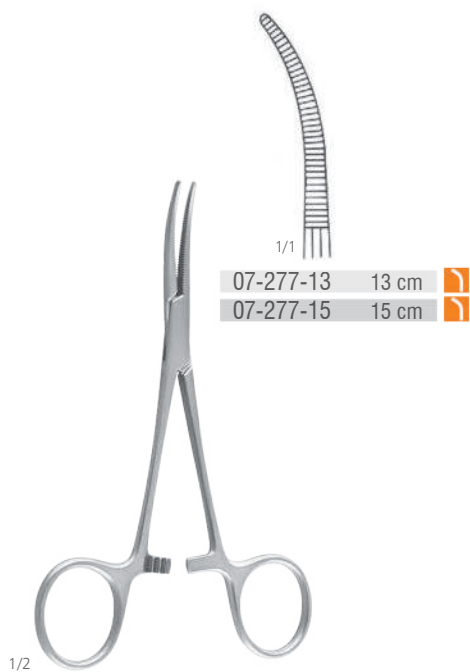

Christophe
 07-277-13 - 07-277-15

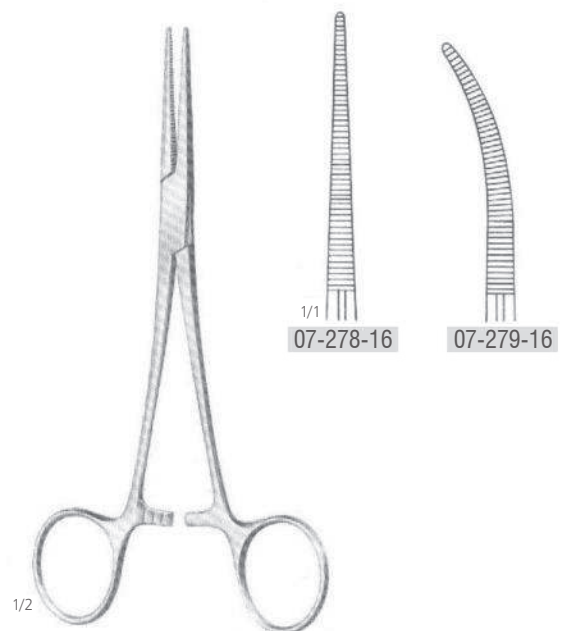

Coller
 07-278-14 14 cm II
 07-278-16 16 cm II
 07-279-14 14 cm II
 07-279-16 16 cm II



Pean
07-280-13 - 07-281-16
Delicate Pattern

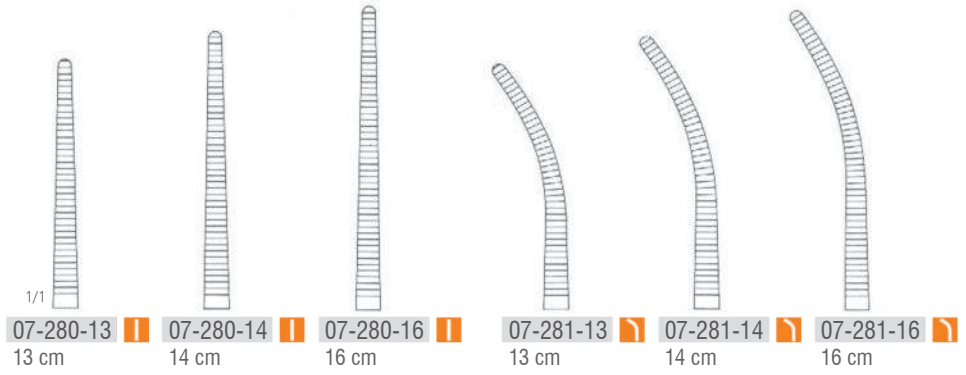

Kocher
07-286-13 - 07-287-16
Delicate Pattern
1:2 Teeth

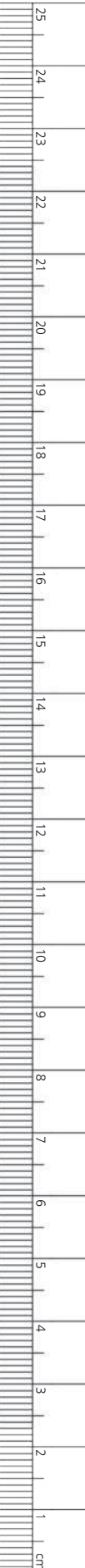
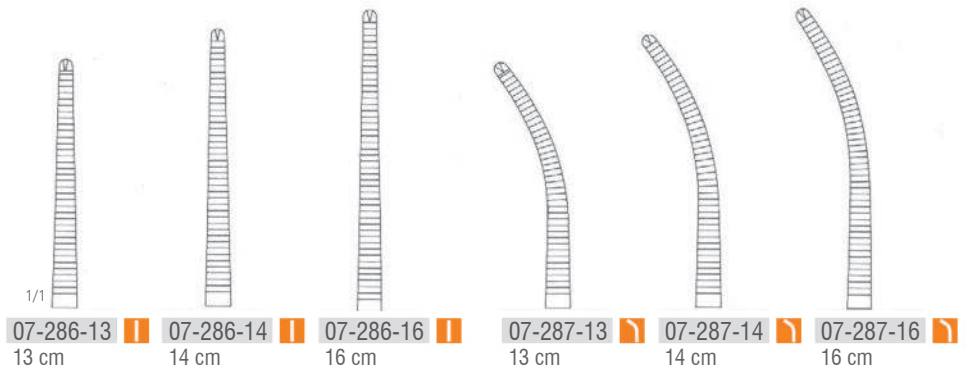

Forceps - Zange - Fórceps - Forceps

07

Artery Forceps
 Arterienklemme
 Pinzas Arteriales
 Forceps d'artère



Pean - Nippon
 07-290-14 - 07-291-18

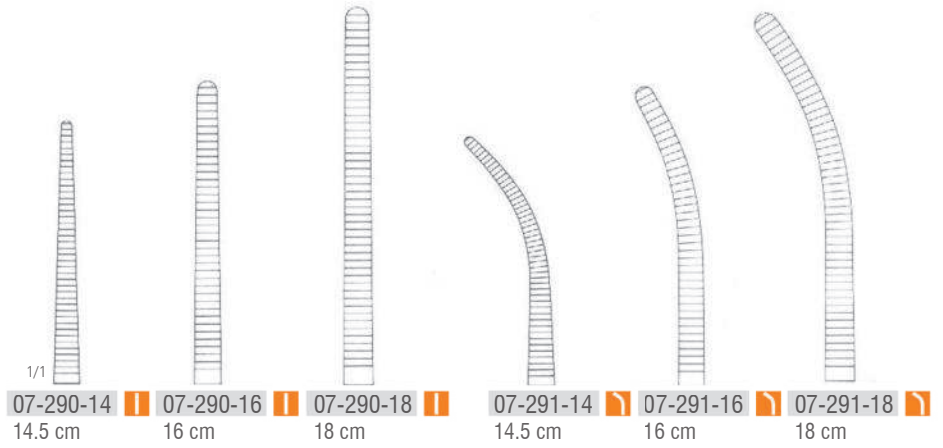

Kocher - Nippon
 07-296-14 - 07-297-18
 1:2 Teeth

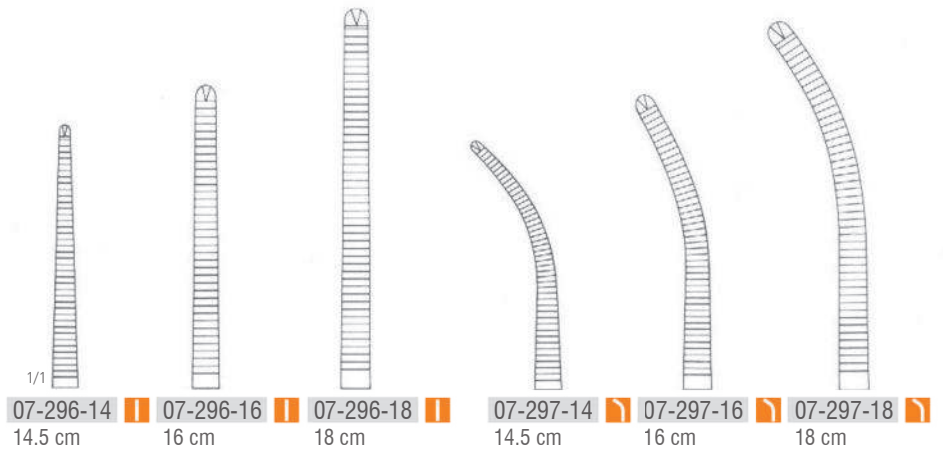

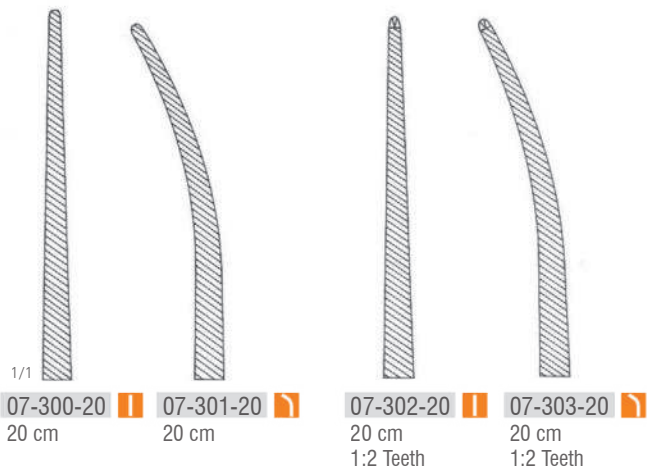

Bangolea
07-300-20 - 07-303-29

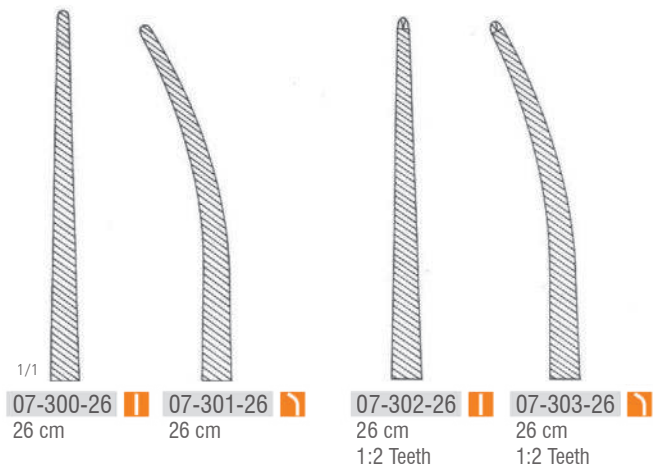

Forceps - Zange - Fórceps - Forceps

07

Artery Forceps
 Arterienklemme
 Pinzas Arteriales
 Forceps d'artère

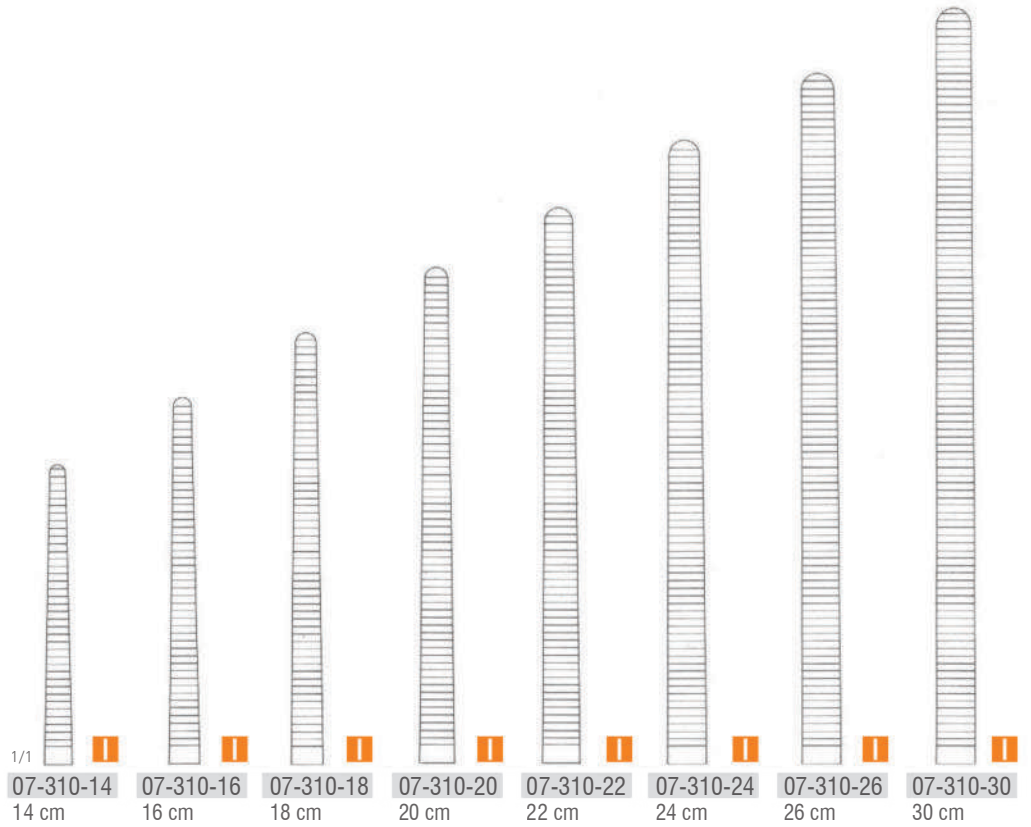

Rochester Pean
 07-311-14 - 07-311-30

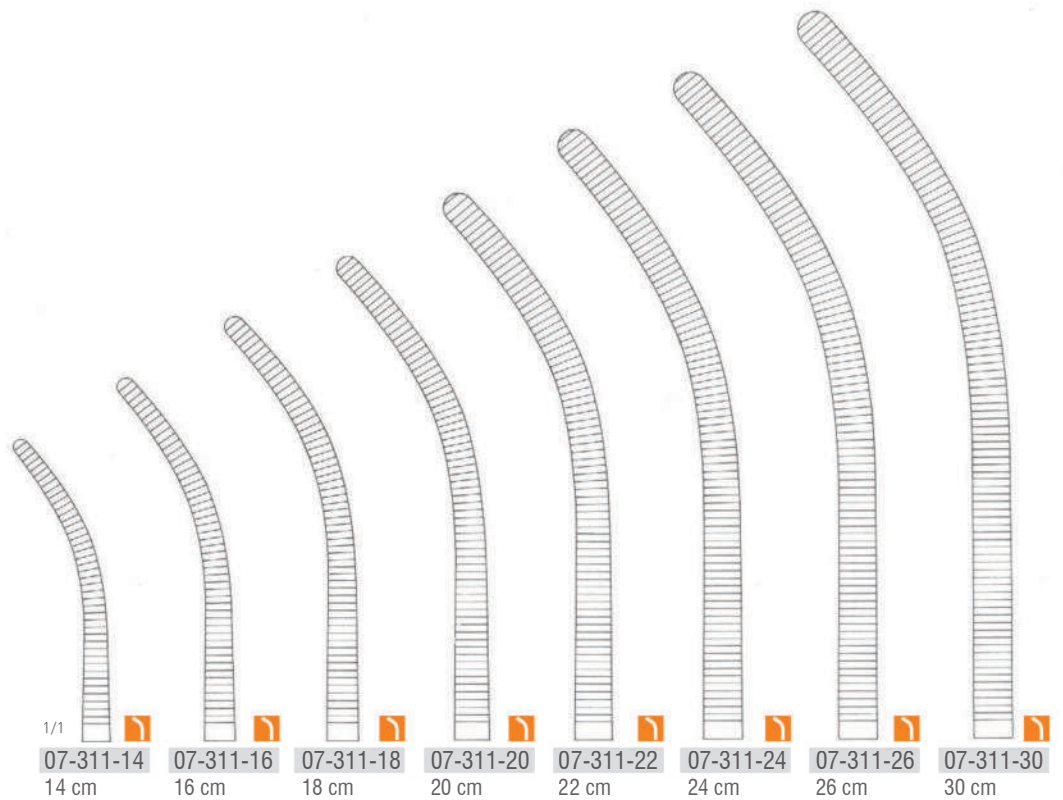

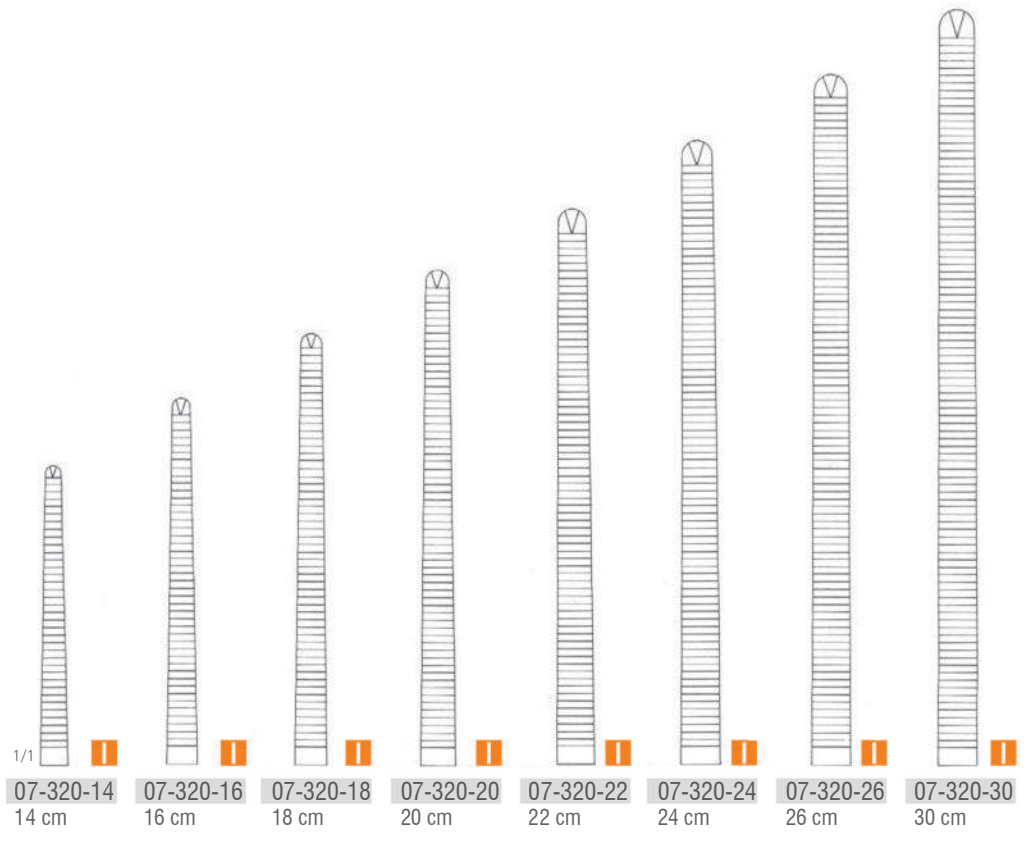

Kocher (Ochsner)
07-321-14 - 07-321-30
1:2 Teeth

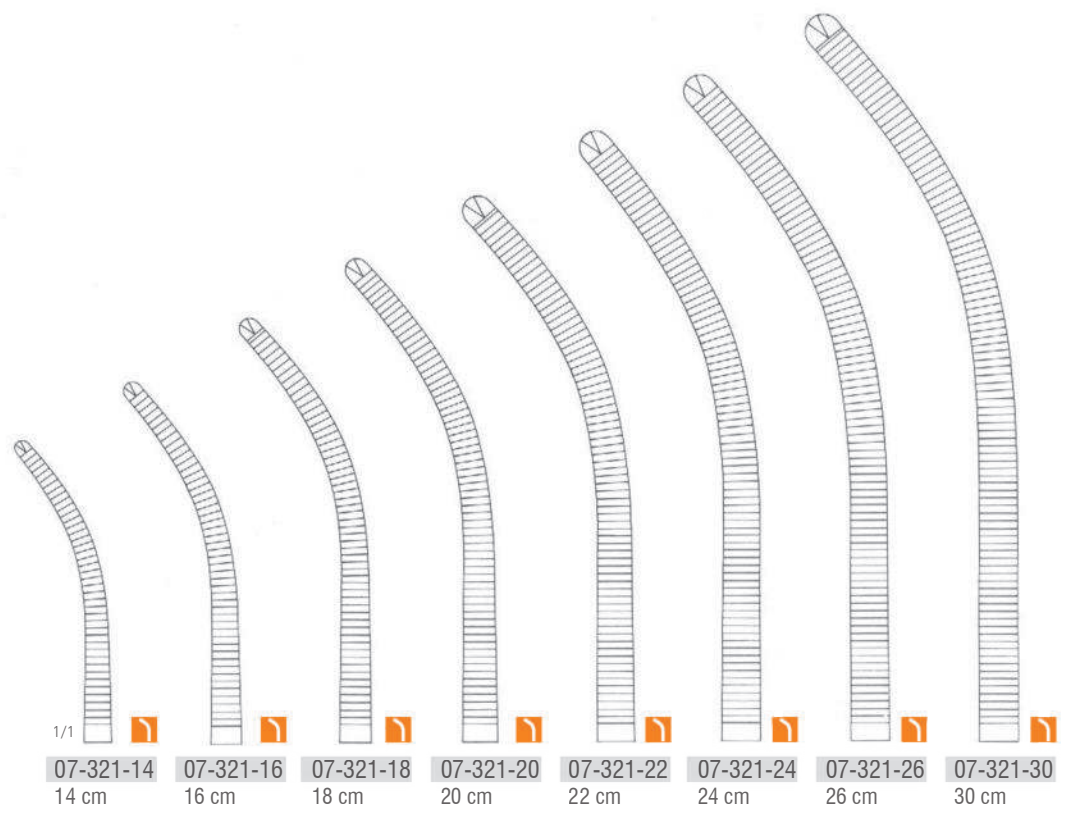

Forceps - Zange - Fórceps - Forceps

Artery Forceps, Dissecting and Ligature Forceps
 Arterienklemme, Präparier- und Ligaturklemme
 Pinzas de arteria, pinzas de disección y ligadura
 Forceps d'artère, forceps de dissection et de ligature

07

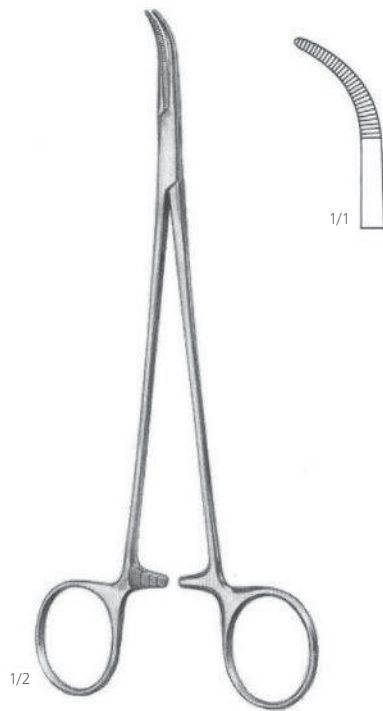

Baby - Mixer
 07-331-18
 18 cm

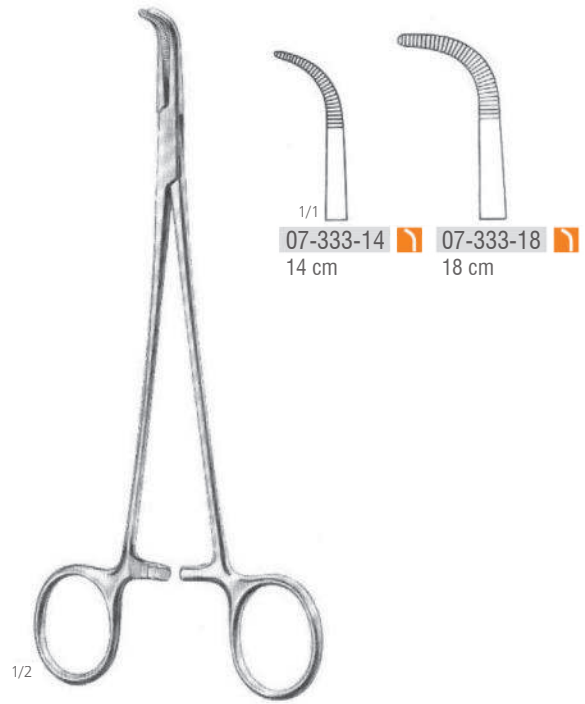

Baby - Adson
 07-333-14 - 07-333-18

07-333-14 14 cm
 07-333-18 18 cm



Heiss
 07-334-20 - 07-337-20
 20 cm

07-334-20 07-335-20 07-337-20

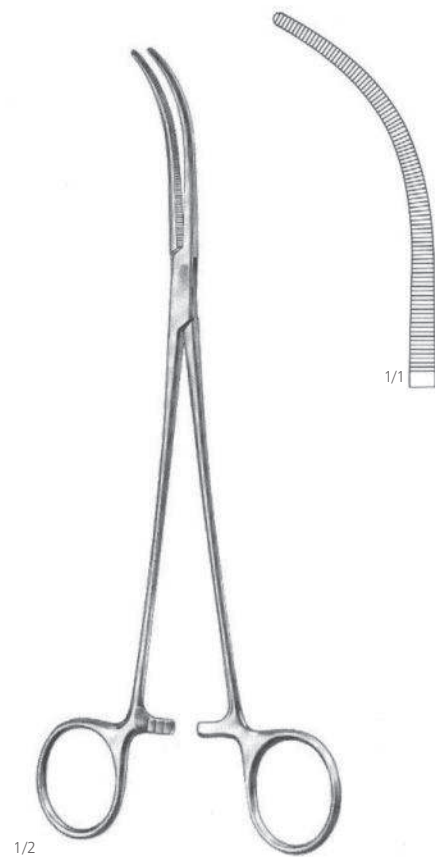

Overhalt - Mixer
 07-339-21
 21 cm

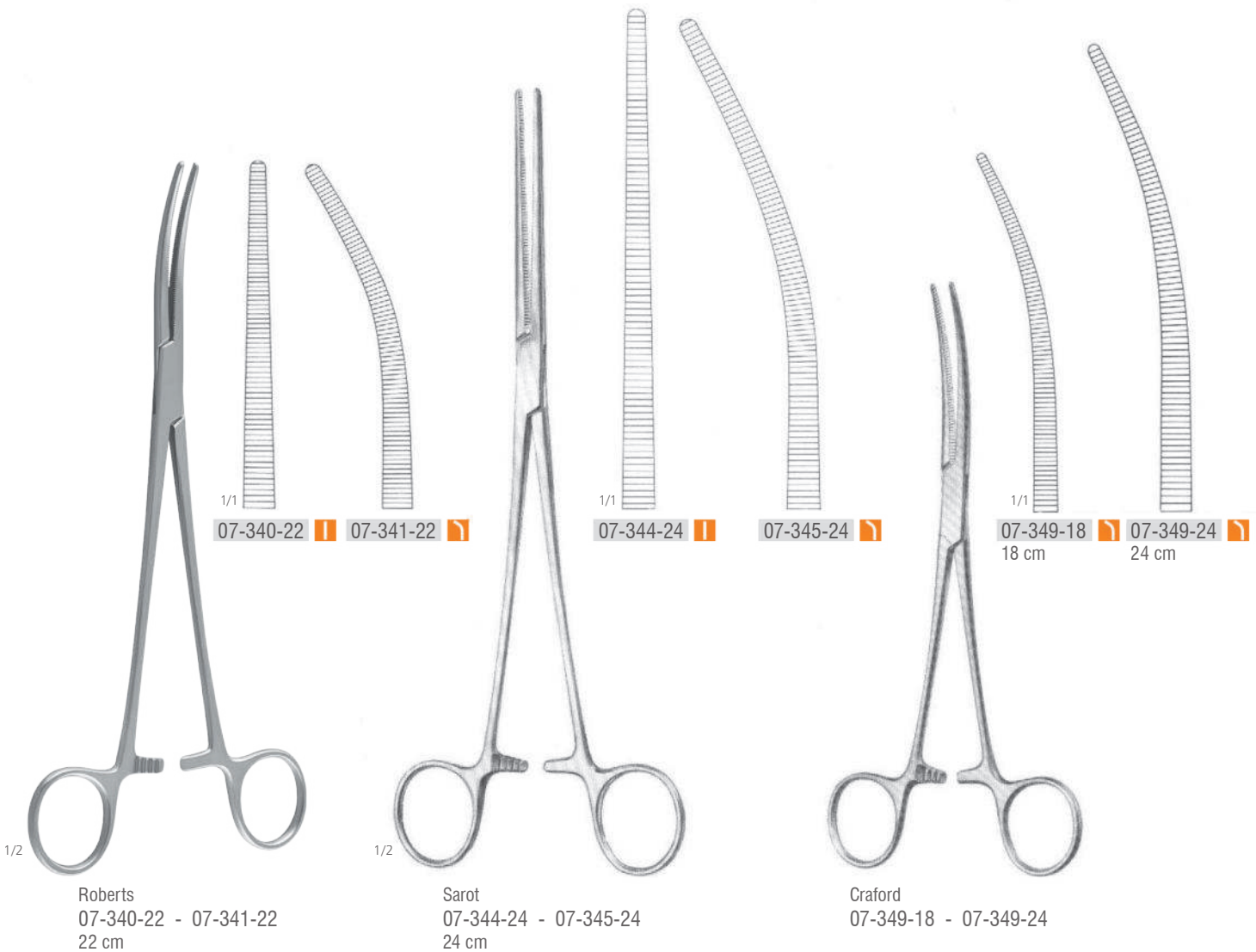

Forceps - Zange - Fórceps - Forceps

07

Artery Forceps, Dissecting and Ligature Forceps
 Arterienklemme, Präparier- und Ligaturklemme
 Pinzas de arteria, pinzas de disección y ligadura
 Forceps d'artère, forceps de dissection et de ligature

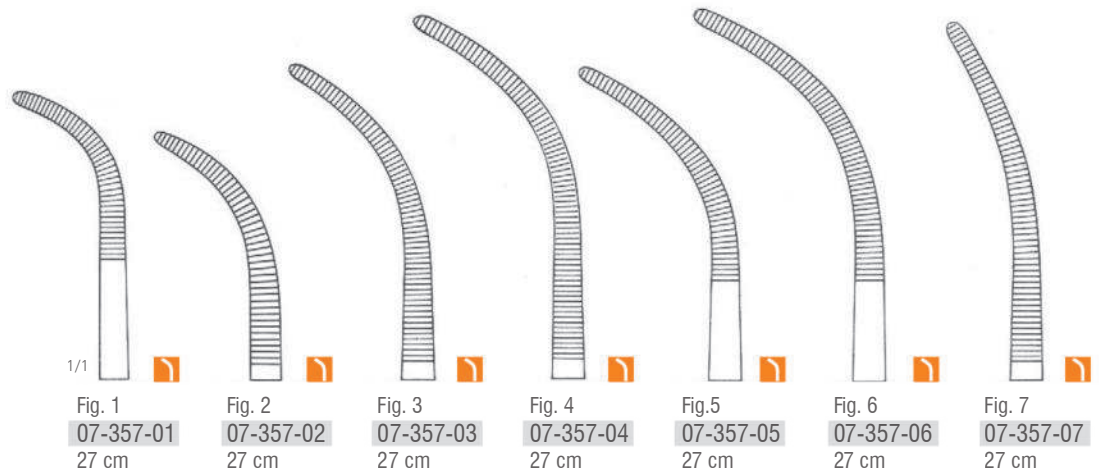
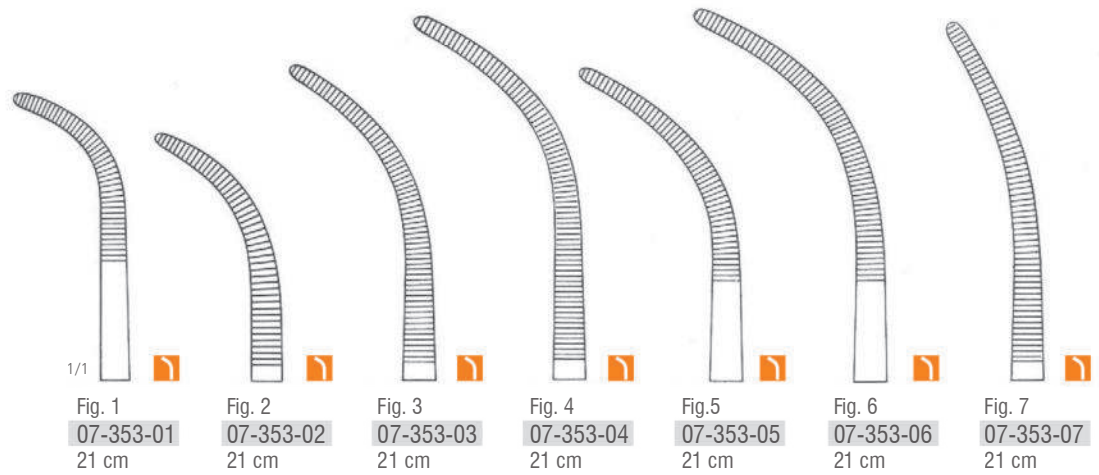

Overholt - Geissendoerfer
 07-353-01 - 07-357-07



Rumel
 07-361-01 - 07-361-05
 23 cm



1/1
 Fig. 1
 07-361-01

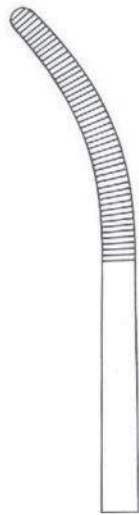

Fig. 2
 07-361-02



Fig. 3
 07-361-03



Fig. 4
 07-361-04



Fig. 5
 07-361-05



Forceps - Zange - Fórceps - Forceps

Artery Forceps, Dissecting and Ligature Forceps
Arterienklemme, Präparier- und Ligaturklemme
Pinzas de arteria, pinzas de disección y ligadura
Forceps d'artère, forceps de dissection et de ligature



1/2

Zenker
07-365-01 - 07-365-02
29.5 cm



1/1

07-365-01



07-365-02



Kelly
07-373-19 - 07-377-24



1/1

Fig. 1
07-373-19



1/1

Fig. 1
07-373-22



1/1

Fig. 1
07-373-24



1/1

Fig. 2
07-375-19



1/1

Fig. 2
07-375-22



1/1

Fig. 2
07-375-24



1/1

Fig. 3
07-377-19



1/1

Fig. 3
07-377-22



1/1

Fig. 3
07-377-24

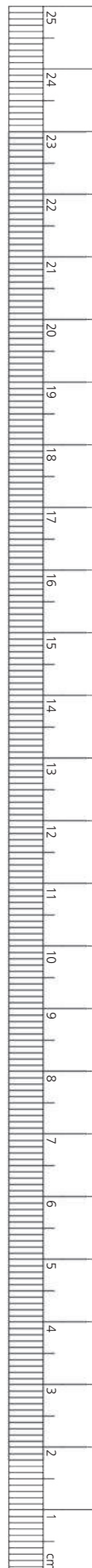

Forceps - Zange - Fórceps - Forceps

Artery Forceps, Dissecting and Ligature Forceps
 Arterienklemme, Präparier- und Ligaturklemme
 Pinzas de arteria, pinzas de disección y ligadura
 Forceps d'artère, forceps de dissection et de ligature

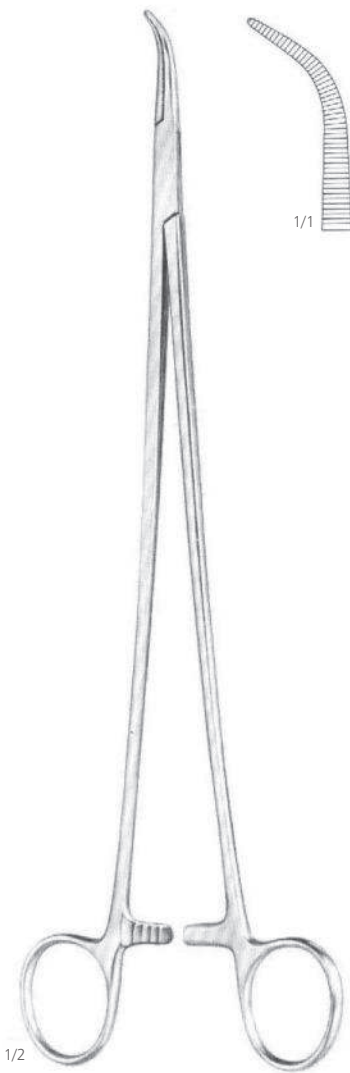

Lawrence
 07-383-27 
 27.5 cm



07-385-18 
 18 cm



07-385-27 
 27.5 cm

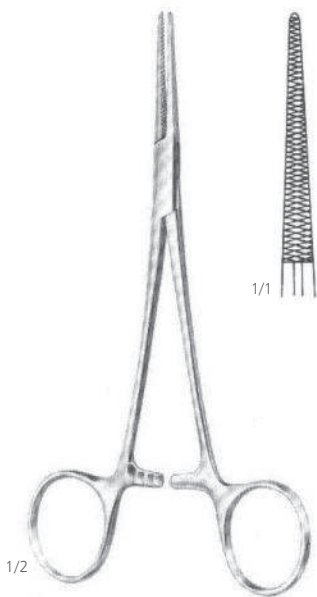
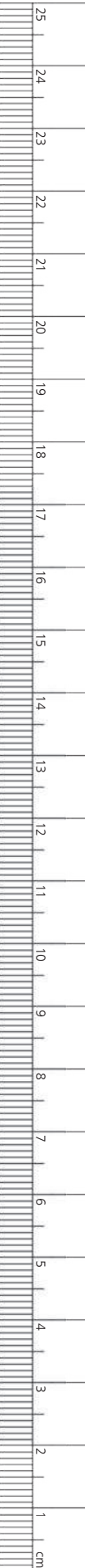

Dixon - Lovelace
 07-390-15 ■■
 15.5 cm

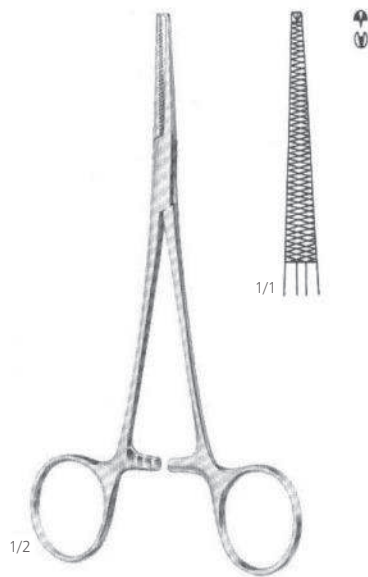

Dixon - Lovelace
 07-392-15 ■■
 15.5 cm
 1:2 Teeth

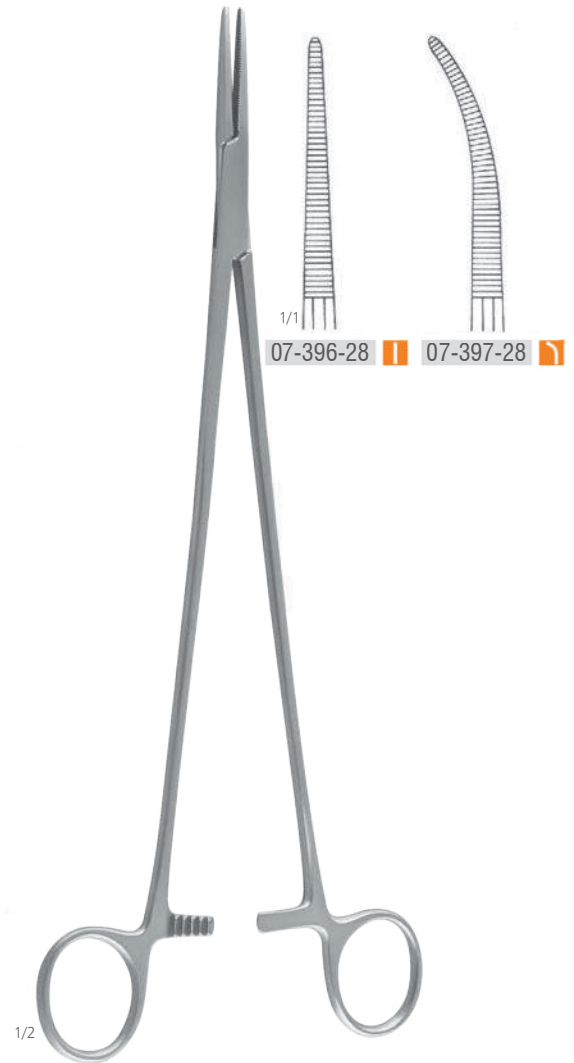

Bridge
 07-396-28 - 07-397-28
 28 cm

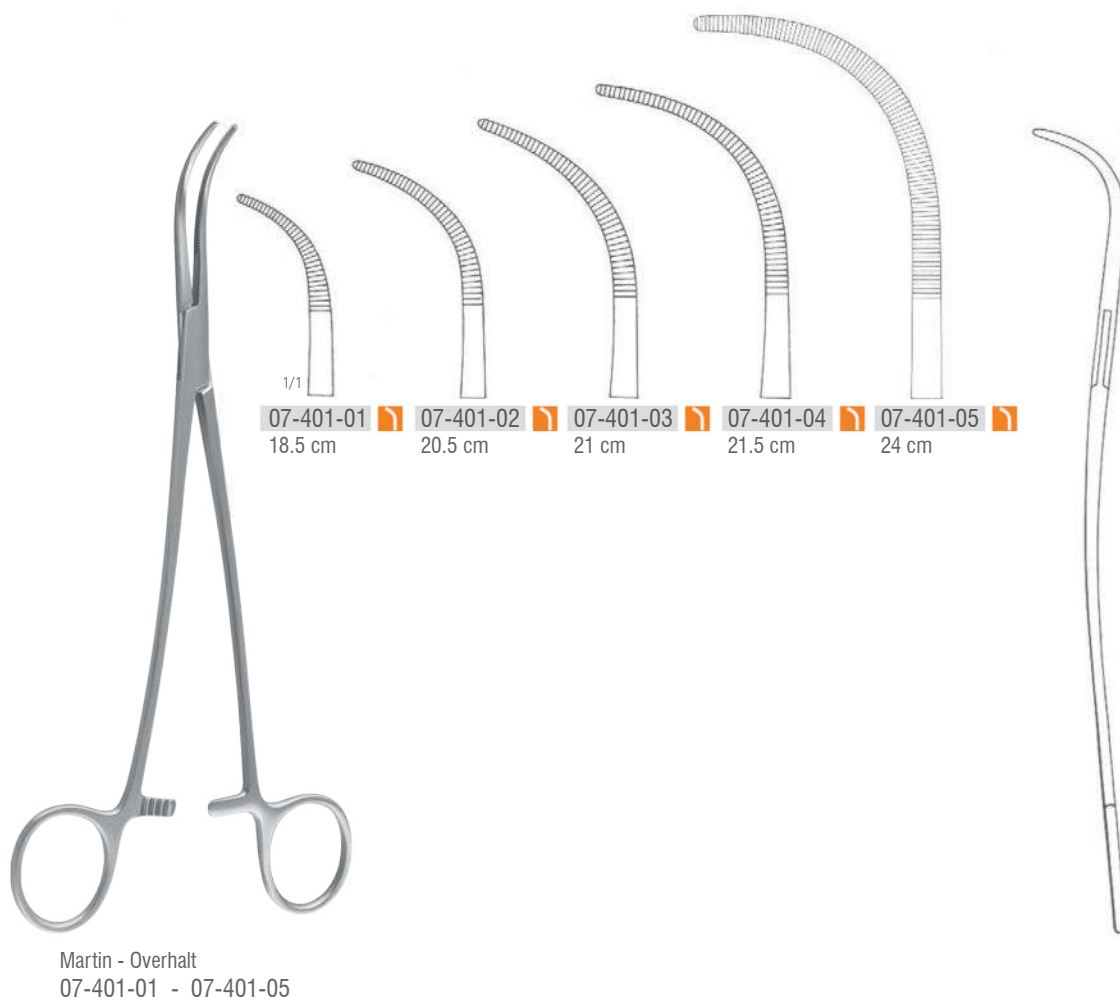



Mini - Gemini
07-403-18 - 07-403-28

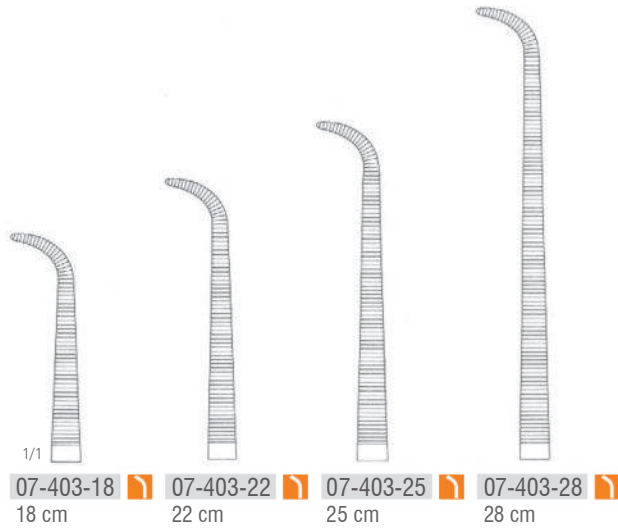

Gemini
07-407-18 - 07-407-28

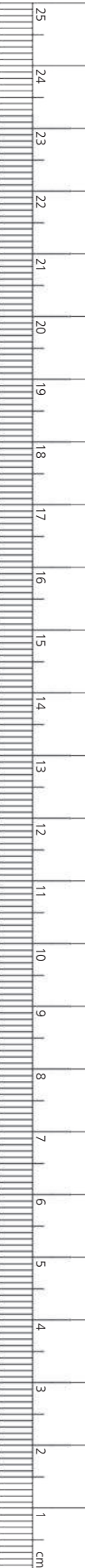
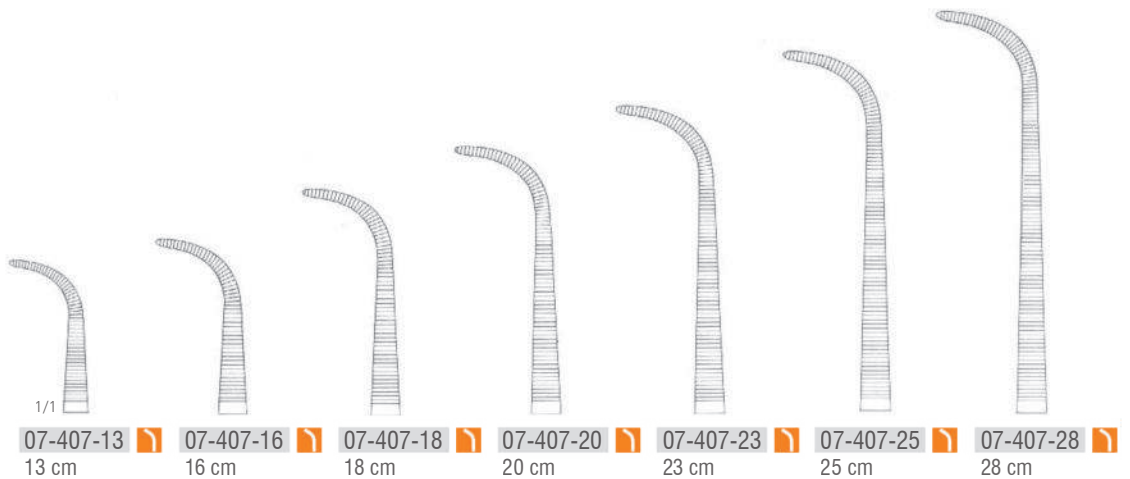

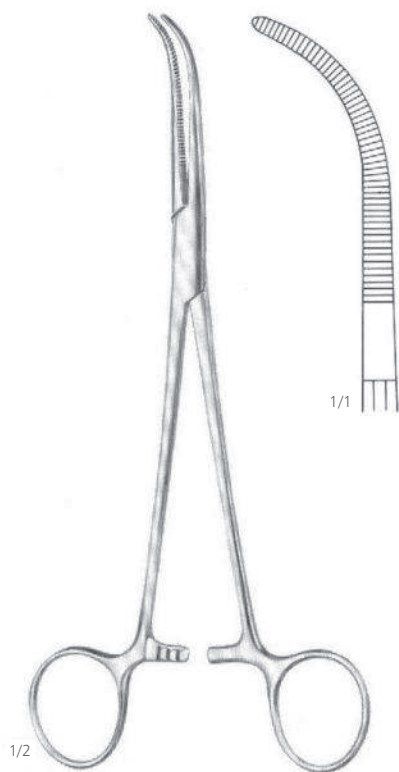

1/2

Johns Hopkins
 07-411-20 
 20 cm

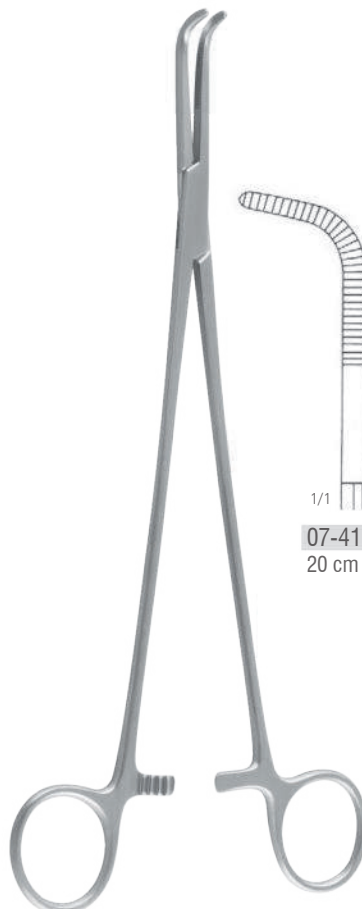

1/1

07-417-20 
 20 cm

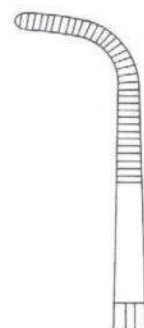

07-417-24 
 24 cm



07-417-28 
 28 cm

Kantowitz
 07-417-20 - 07-417-28

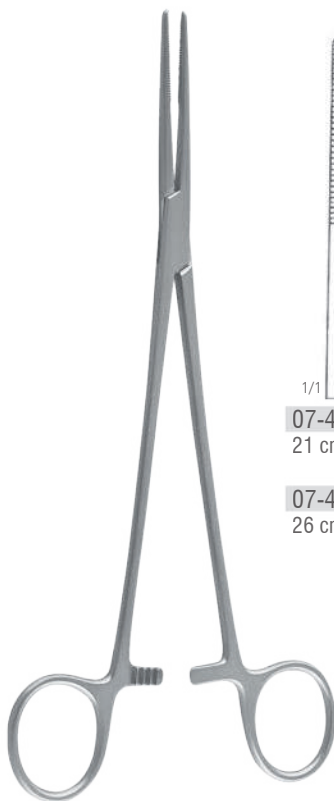
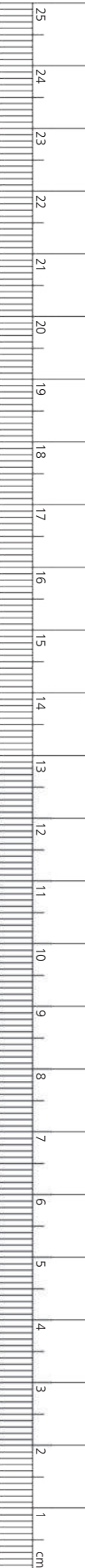

Toennis
07-420-21 - 07-421-26

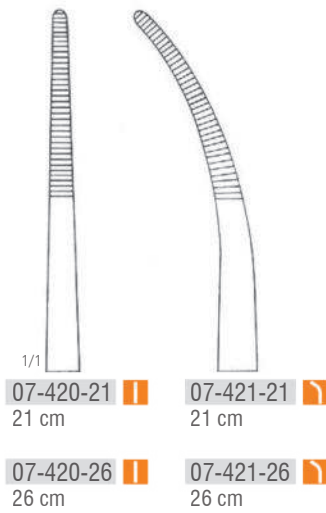

Toennis
07-422-21 - 07-423-26
1:2 Teeth

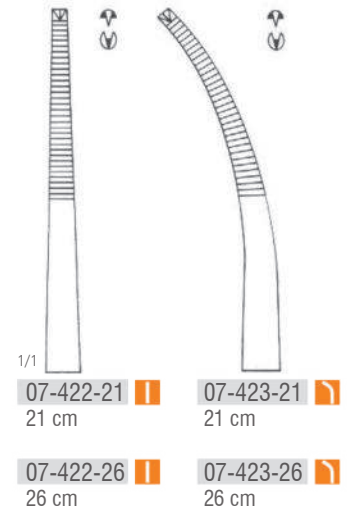

Forceps - Zange - Fórceps - Forceps

07

Bronchus and Gall Duct Clamps
 Bronchus- und Gallengangklappen
 Abrazaderas para bronquios y conductos biliares
 Pinces pour conduits de bronches et de galles



Mixer
 07-431-15 - 07-431-19

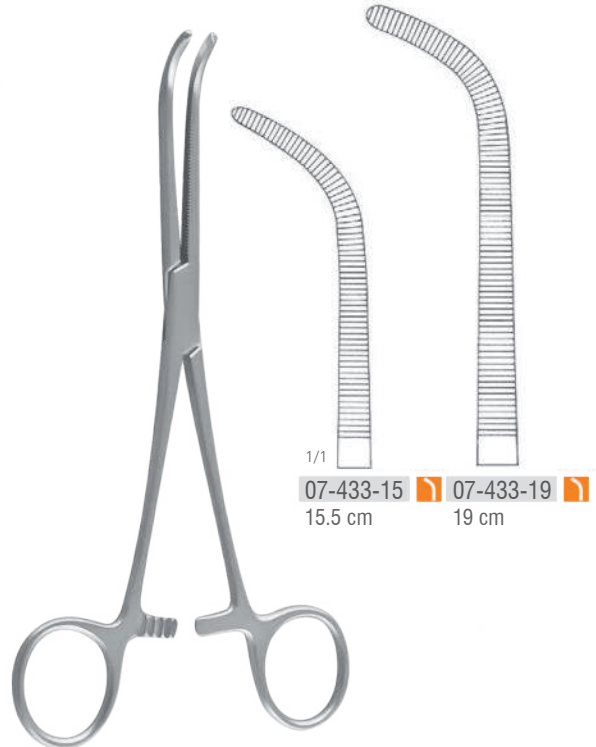

Mixer - O'Shaughnessy
 07-433-15 - 07-433-19



Mixer
 07-437-22
 22 cm



Mixer
 07-439-23
 23 cm



1/1
 07-441-21 21 cm
 07-441-24 24 cm



1/1
 07-445-22 22 cm
 07-447-25 25 cm
 07-449-28 28 cm

Wickstorm
 07-441-21 - 07-441-24

Mixer
 07-445-22 - 07-449-28

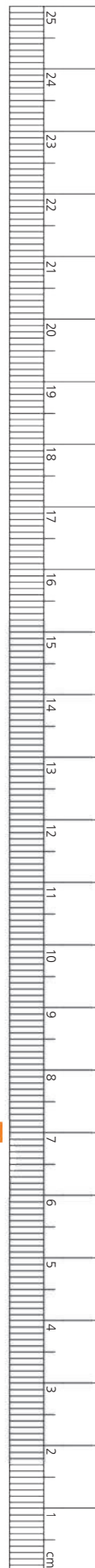

Forceps - Zange - Fórceps - Forceps

Bronchus and Gall Duct Clamps
 Bronchus- und Gallengangklemmen
 Abrazaderas para bronquios y conductos biliares
 Pinces pour conduits de bronches et de galles

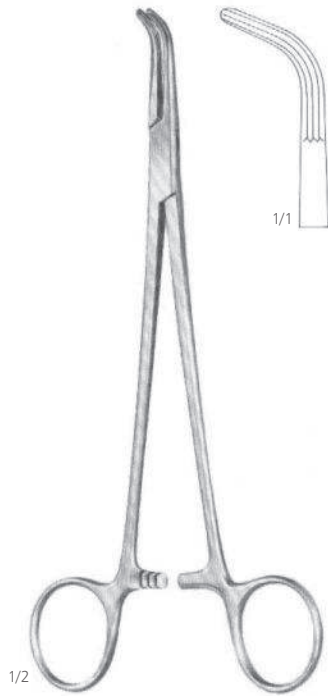

Lower
 07-451-18
 18 cm



Lahey
 07-455-19 - 07-457-23

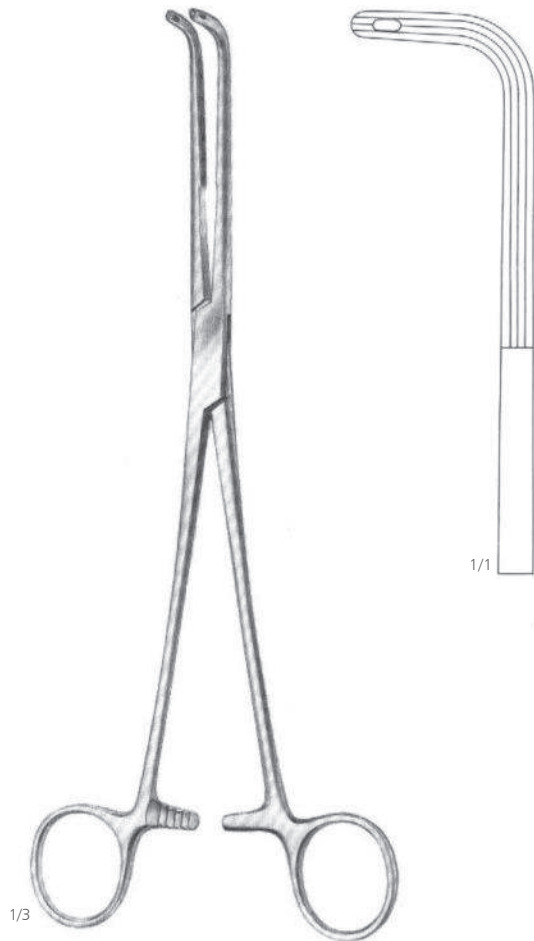

Finochietto
 07-459-24
 24 cm



07-461-22 22 cm

07-461-23 23 cm



07-465-22 22 cm

07-465-23 23 cm

Gray
 07-461-22 - 07-461-28
 18 cm

Gray
 07-465-22 - 07-465-28
 1:2 Teeth

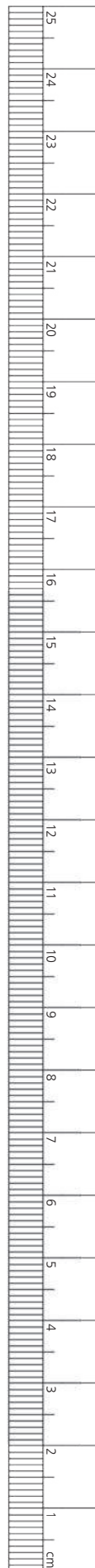
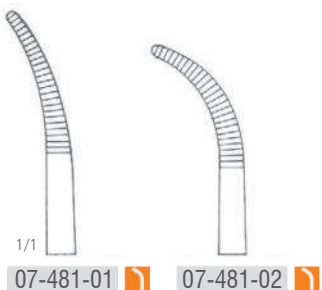

Fig. 1
07-475-19Fig. 2
07-477-19Negus
07-475-19 - 07-477-19
19 cm



07-481-01 07-481-02

1/2

Schmidt - Sawtell
07-481-01 - 07-481-02
19 cm

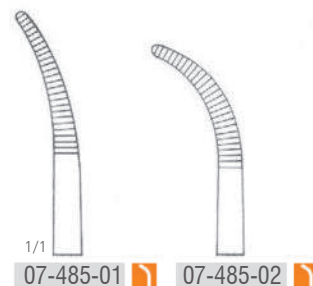
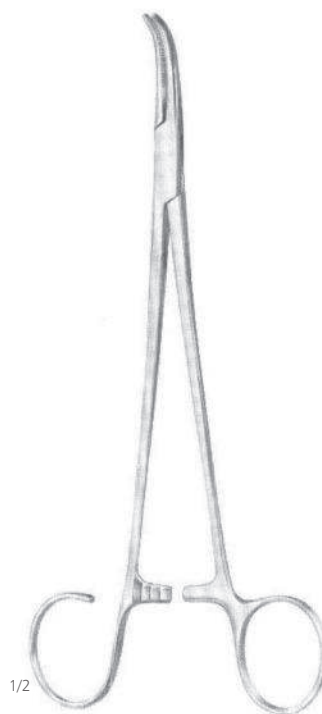

07-485-01 07-485-02

1/2

Schmidt - Sawtell
07-485-01 - 07-485-02
19 cm

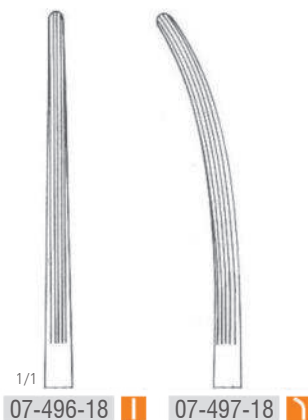

07-496-18 07-497-18

Bainbridge

07-496-15	15 cm
07-496-18	18 cm
07-497-15	15 cm
07-497-18	18 cm



Forceps - Zange - Fórceps - Forceps

07

Auricle Forceps
Ohrzange
Pinzas de aurícula
Forceps d'auricule



Atrauma

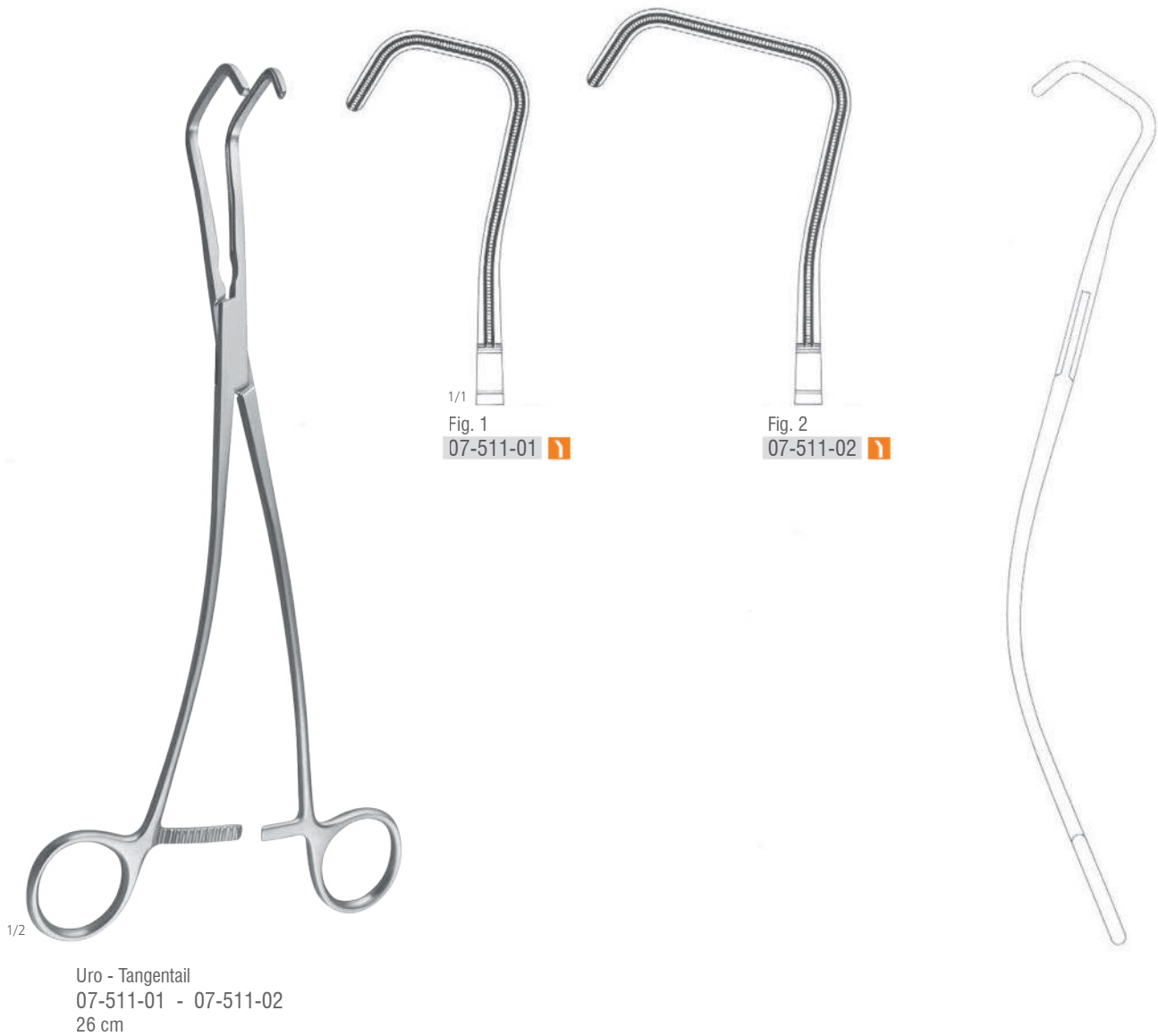

Atrauma

Guyon
07-517-23 - 07-517-2407-517-23
23 cm07-517-24
24 cm



Guyon
 07-521-20 - 07-521-24

Guyon
 07-523-23

Forceps - Zange - Fórceps - Forceps

07

Kidney Pedicle Clamps
 Pedikelklemmen für Nieren
 Pinzas de pedículo renal
 Pincas de pédicule rénal





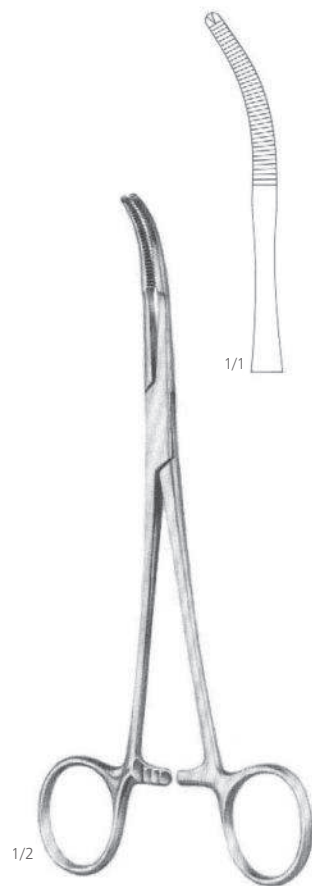

Baby - Mikulicz
 07-541-14 
 14 cm
 1:2 Teeth



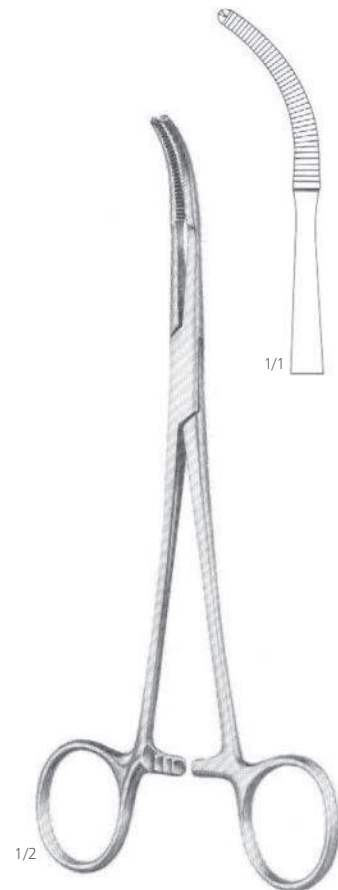

Mikulicz
 07-545-18 
 18 cm
 1:2 Teeth

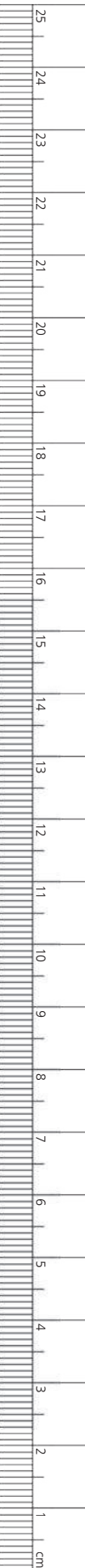

Mikulicz
 07-547-20 
 20 cm
 1:2 Teeth

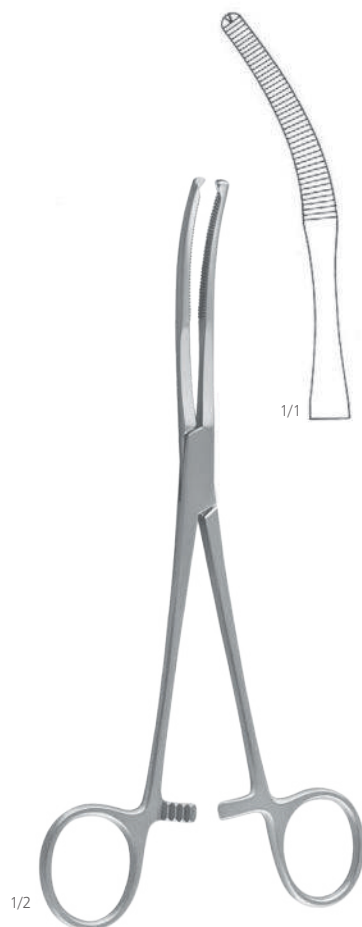



Mikulicz
07-551-20 
20 cm
1:2 Teeth

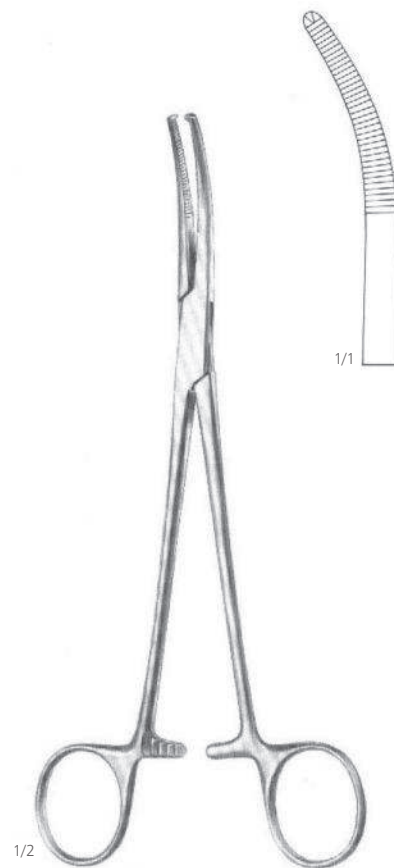

Mikulicz
07-555-20 
20.5 cm
1:2 Teeth

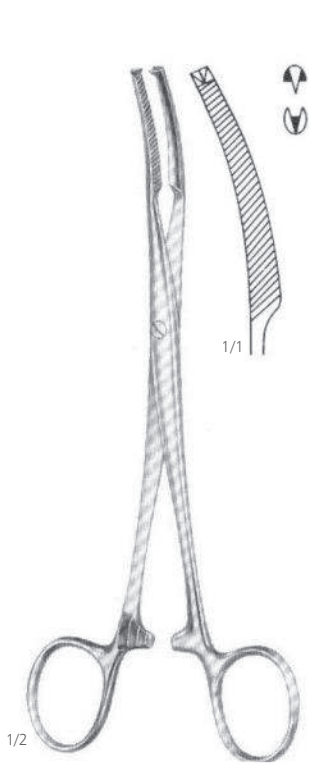

Mikulicz
 07-561-18
 18 cm
 1:2 Teeth

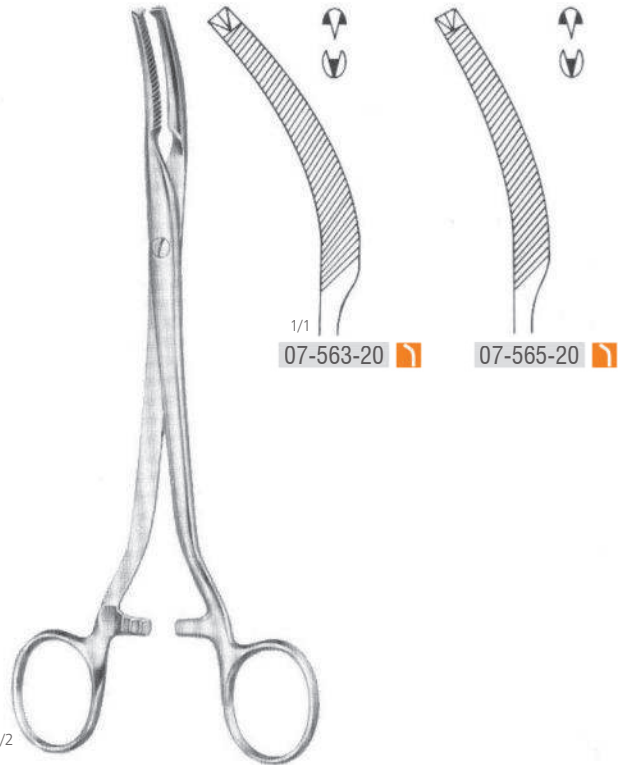

Mikulicz
 07-563-20 - 07-565-20
 20 cm
 1:2 Teeth

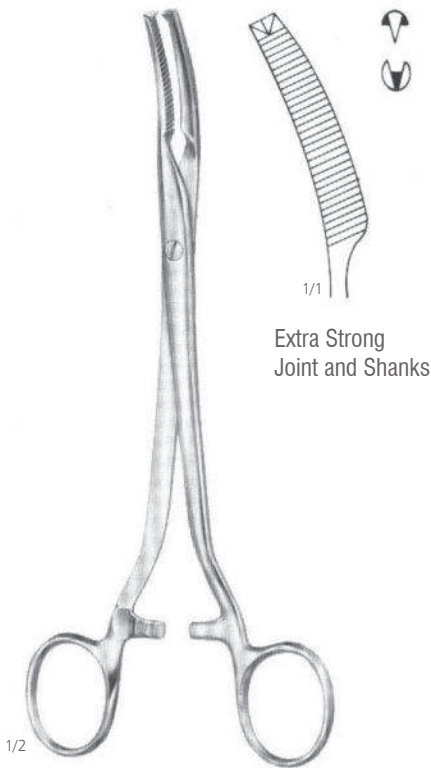

Mikulicz
 07-567-20
 20.5 cm
 1:2 Teeth

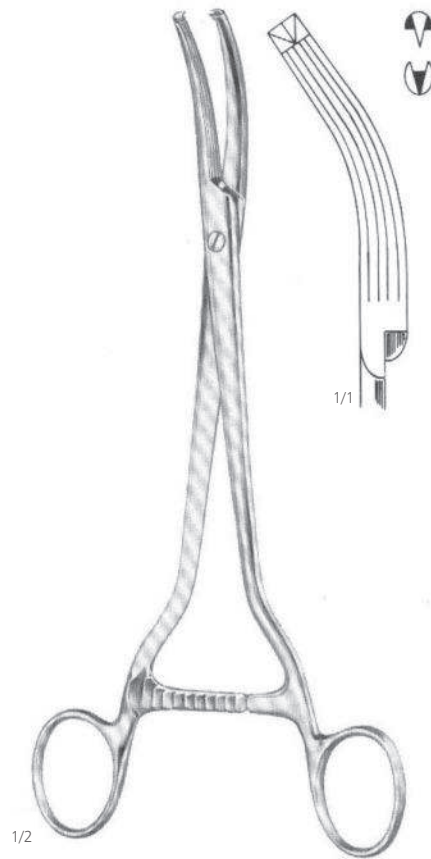

Mikulicz
 07-569-23
 23 cm
 1:2 Teeth

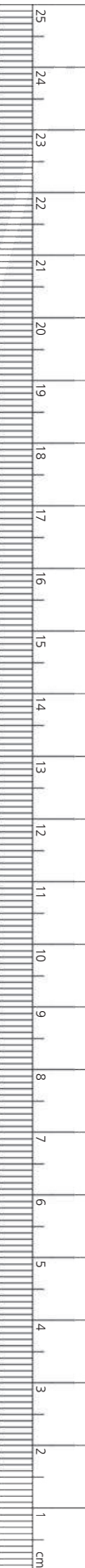

Forceps - Zange - Fórceps - Forceps

07

Peritoneal Clamp Forceps
 Peritoneal Clamp Pinzette
 Pinzas de pinza peritoneal
 Forceps de pince péritonéale

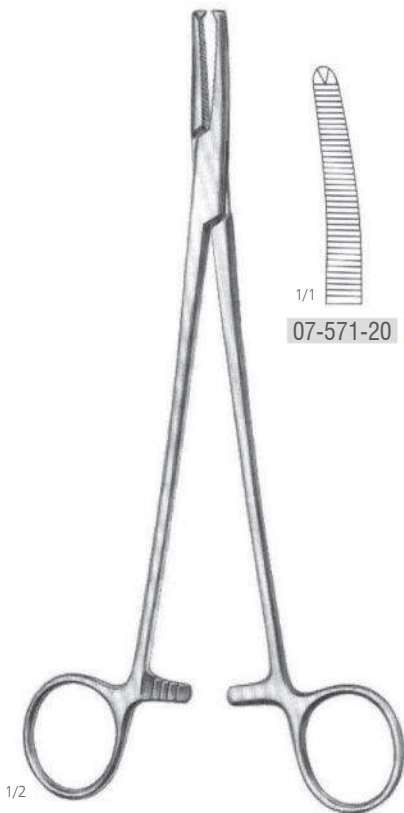

07-571-20  07-573-20 

Faure
 07-571-20 - 07-573-20
 20 cm
 1:2 Teeth

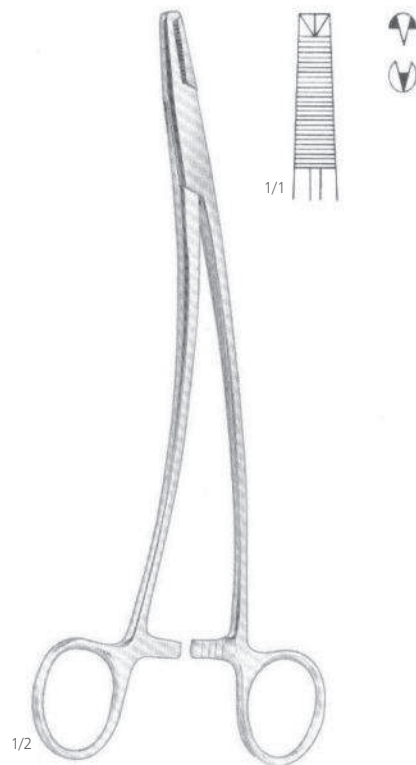

Schindler
 07-577-20
 20 cm
 1:2 Teeth



Wertheim - Cullen
07-585-21 
21.5 cm



Forceps - Zange - Fórceps - Forceps

07

Hysterectomy and Vaginal Forceps
 Hysterektomie und Vaginalzange
 Histerectomía y fórceps vaginales
 Hystérectomie et forceps vaginal

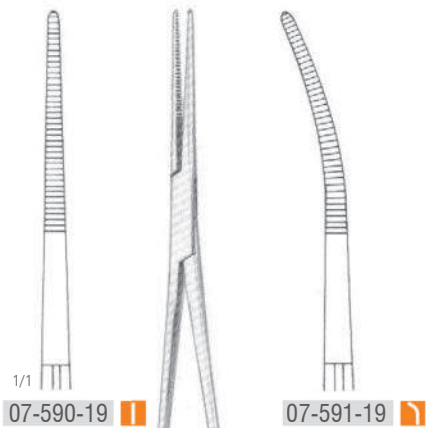

07-590-19

07-591-19



1/2

Birkett
 07-590-19 - 07-591-19
 19 cm

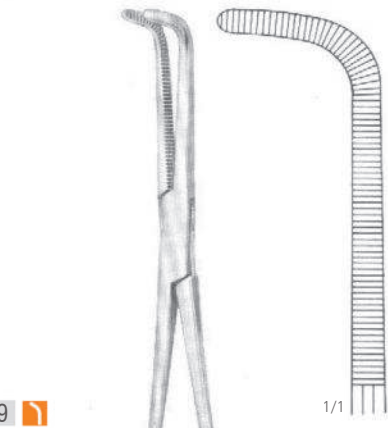

1/1

1/2

Wikstroem
 07-593-19
 19 cm

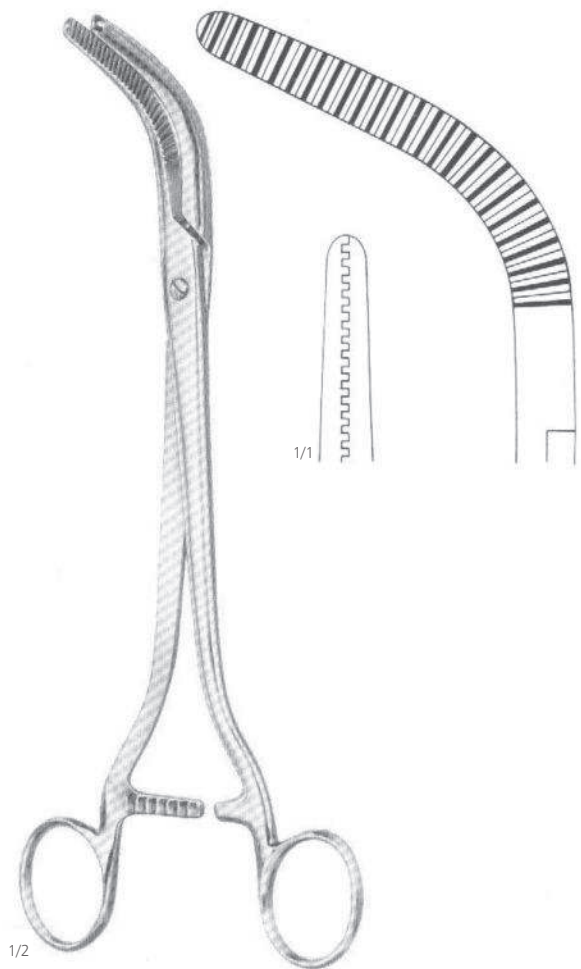
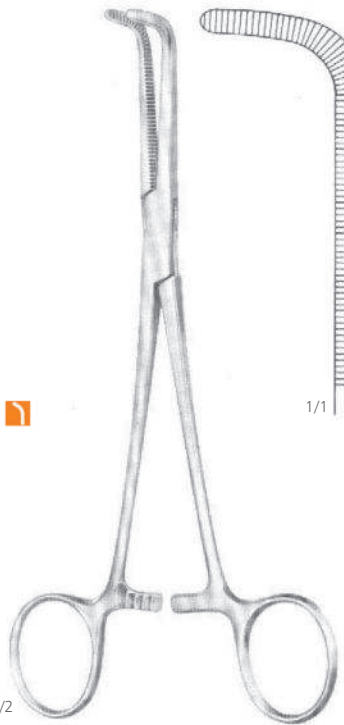

1/1

1/2

Wertheim
 07-599-27
 27 cm

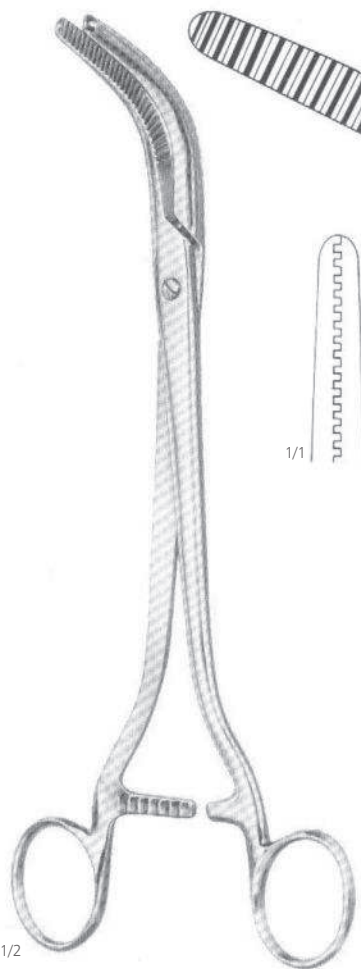



Phaneuf
 07-600-21 - 07-601-21
 21 cm
 1:2 Teeth

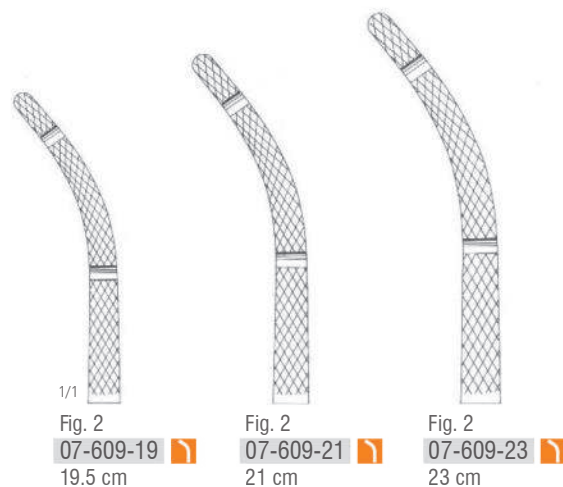
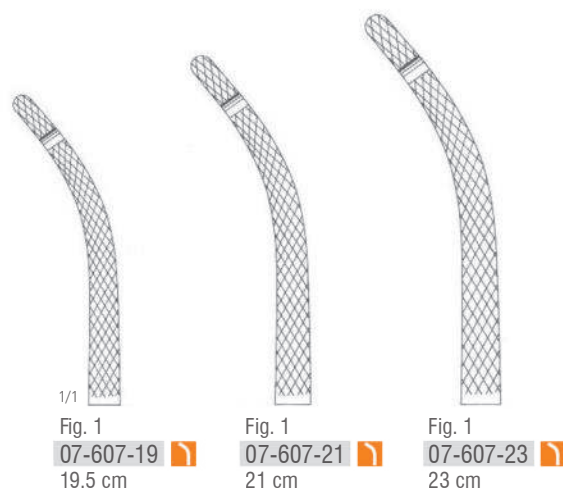
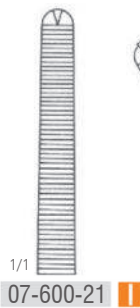

Heaney
 07-607-19 - 07-609-23

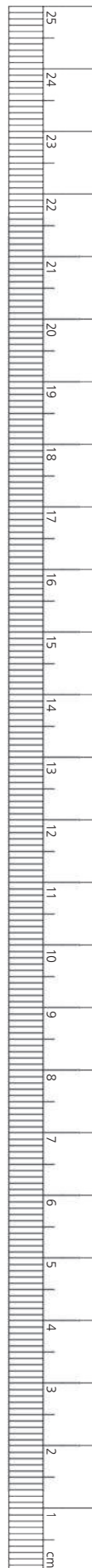

Forceps - Zange - Fórceps - Forceps

07

Hysterectomy and Vaginal Forceps
 Hysterektomie und Vaginalzange
 Histerectomía y fórceps vaginales
 Hystérectomie et forceps vaginal



1/1
 07-613-23
 23 cm

07-615-24
 24 cm

Moynihan
 07-613-23 - 07-615-24



1/2

Wertheim
 07-621-25
 25 cm



1/1
 07-625-22
 22 cm
 Slightly curved

1/1
 07-627-23
 23 cm
 More curved

Wertheim
 07-625-22 - 07-627-23
 1:2 Teeth



Rogers
 07-635-10 - 07-637-40

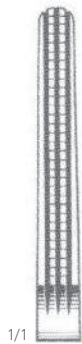

1/1
 Fig. 1
 07-635-10 II
 22 cm

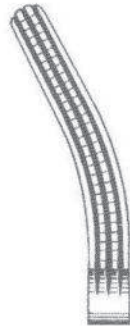

Fig. 2
 07-635-20 I
 21.5 cm

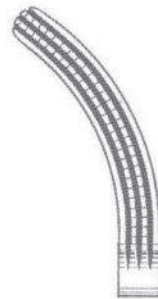

Fig. 3
 07-635-30 I
 21 cm

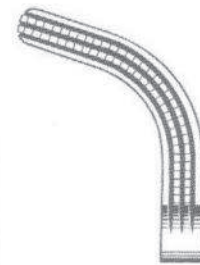

Fig. 4
 07-635-40 I
 20.5 cm



1/1
 Fig. 1
 07-637-10 II
 25 cm

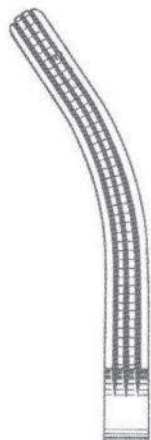

Fig. 2
 07-637-20 I
 25 cm

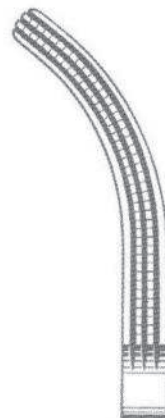

Fig. 3
 07-637-30 I
 24.5 cm

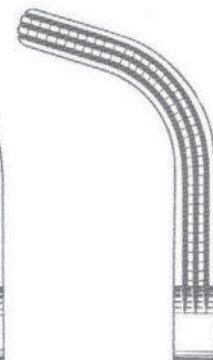
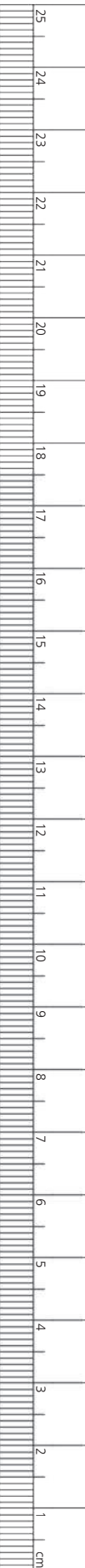

Fig. 4
 07-637-40 I
 23 cm



Forceps - Zange - Fórceps - Forceps

07

Hysterectomy Forceps
 Hysterektomiezange
 Pinzas de histerectomía
 Forceps d'hystérectomie

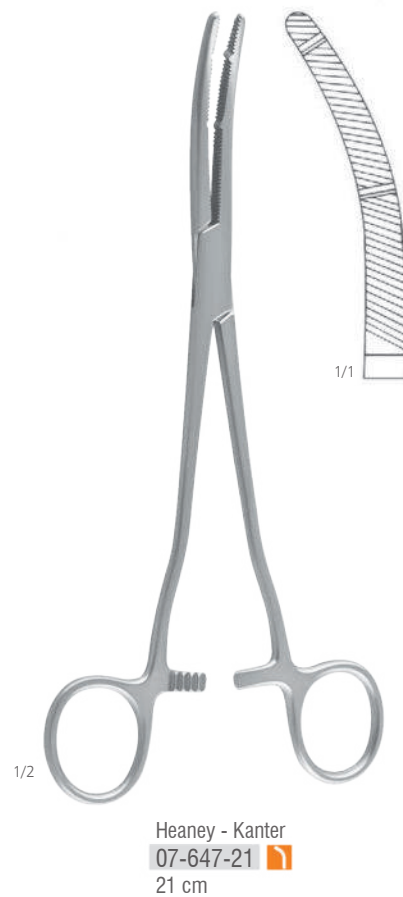
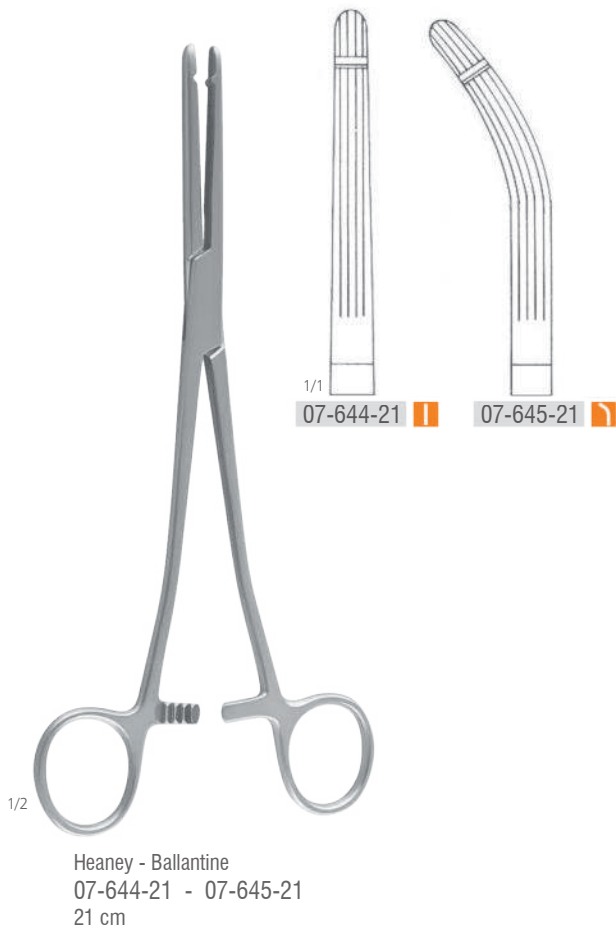

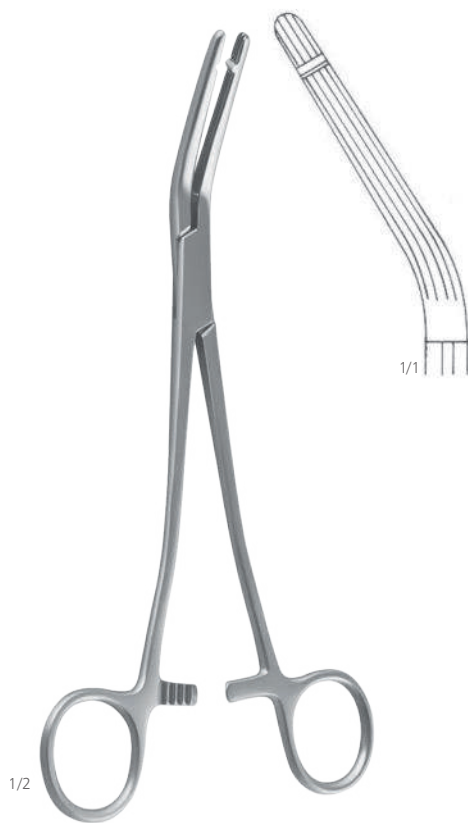

Garland
 07-653-21 
 21 cm

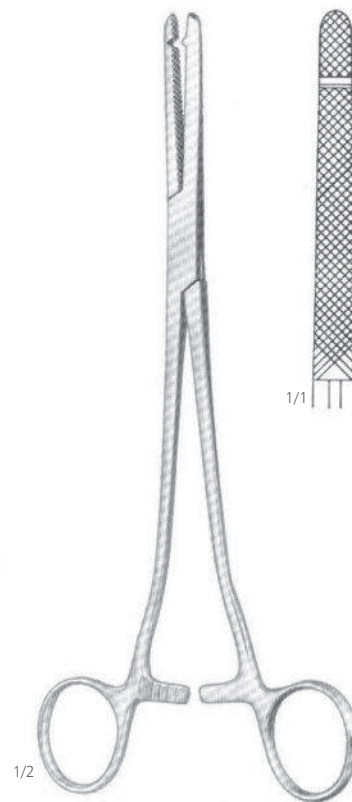

Heaney - Rezak
 07-657-21 
 21 cm

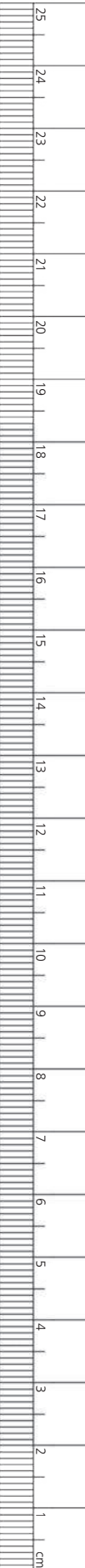

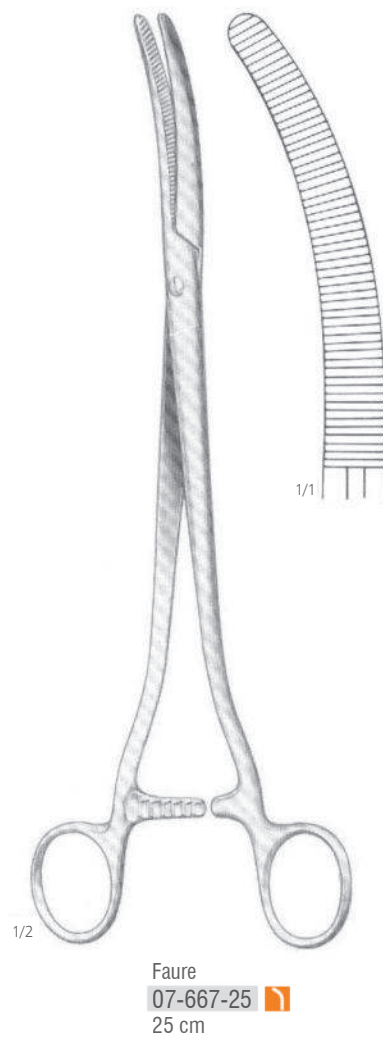
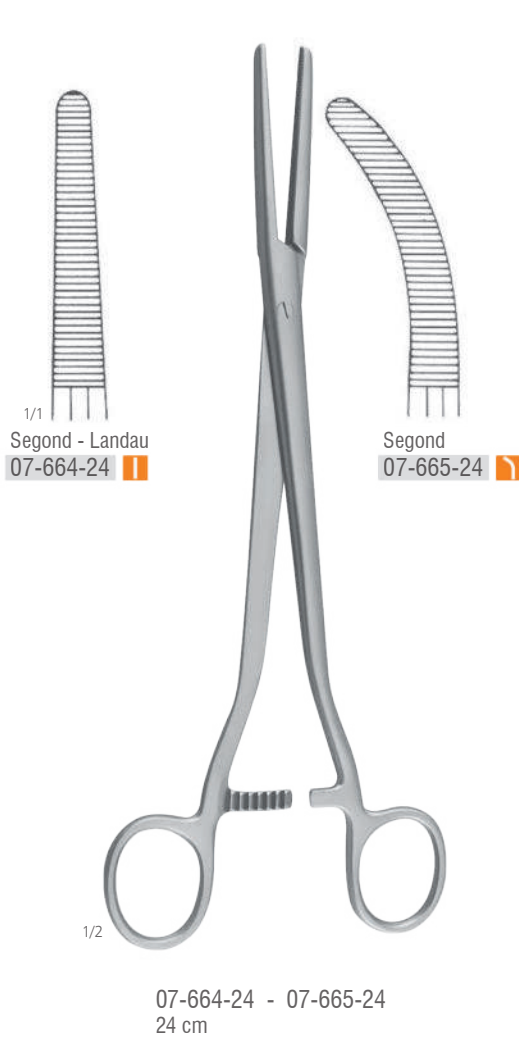



1/2

Schaedel
07-671-09 
9 cm



Jones

07-673-05 5 cm 
07-673-09 9 cm 



1/2

Jones - Martin
07-675-09 
9 cm
With clip



Backhaus

07-681-11 11 cm 
07-681-13 13 cm 
Delicate pattern

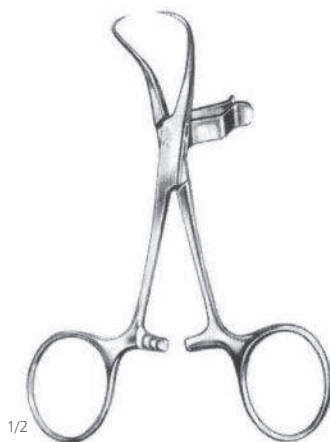

1/2



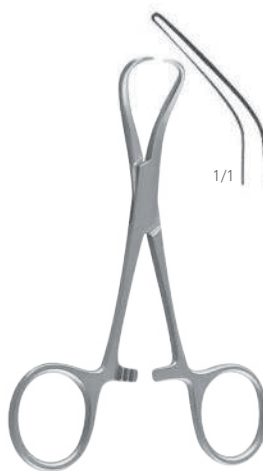

Backhaus

07-683-11 
11 cm
With clip



1/1

Backhaus

07-685-08 8 cm 
07-685-11 11 cm 
07-685-15 15 cm 
07-685-18 18 cm 



Roeder

07-687-15 15 cm 
07-687-18 18 cm 

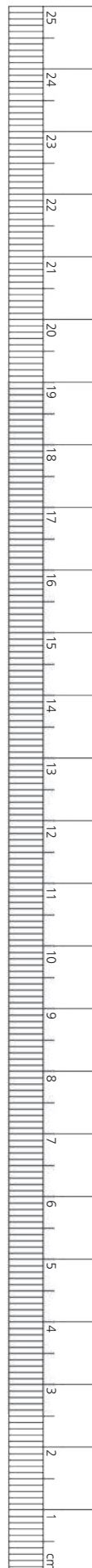

Forceps - Zange - Fórceps - Forceps

07

Towel Forceps
Handtuchzange
Pinzas de toalla
Forceps de serviette



Lorna

07-691-10	10 cm	
07-691-13	13 cm	



Lane

07-695-20	20 cm	
-----------	-------	--

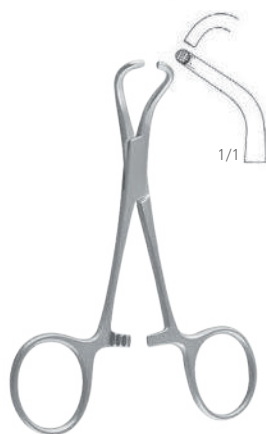

Tohoku

07-697-10	10 cm	
07-697-13	13 cm	

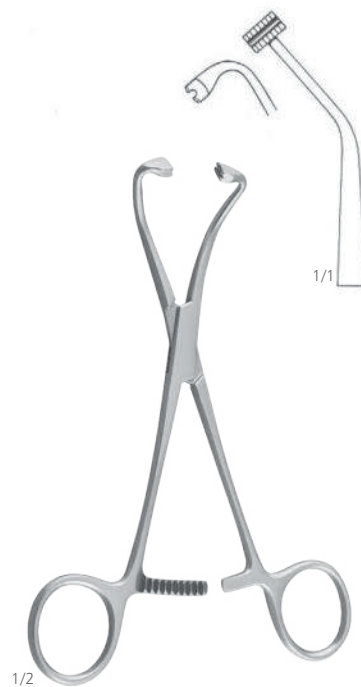

Peers - Bertram

07-699-14	14 cm	
-----------	-------	--



Engl. Modell
07-703-09
9 cm



Doyen
07-705-11
11 cm



Doyen
07-707-18 
18 cm



Bernhard
07-713-16 
16.5 cm





Klinikum
07-720-14 
14.5 cm
With extra long ratchet

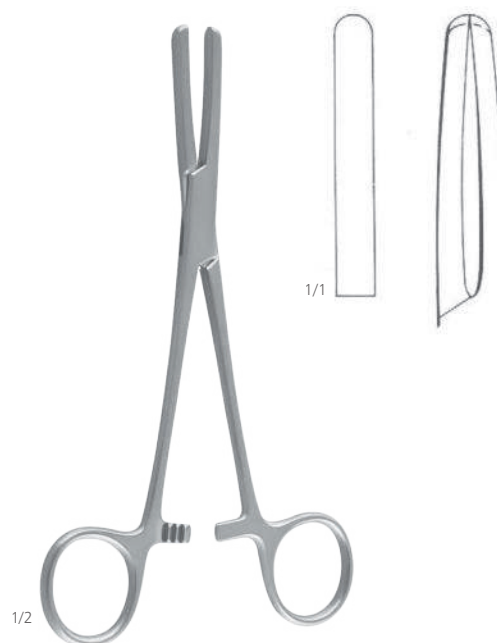

Presbyterian
07-724-16 
16.5 cm



Standard
07-730-15 - 07-730-20



07-730-15 ||
15 cm



07-730-18 ||
18 cm



07-730-20 ||
20 cm



07-734-15 - 07-734-20
With safety guard

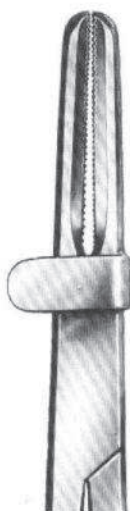

07-734-15 ||
15 cm



07-734-18 ||
18 cm



07-734-20 ||
20 cm

