

Otology
Otologie
Otología
Otologie
Otologia

22





Micro Ear Forceps

Mikro-Ohrzängchen
 Micro pinzas auriculares
 Micro Pince auriculaires
 Micro Pinze auricolari

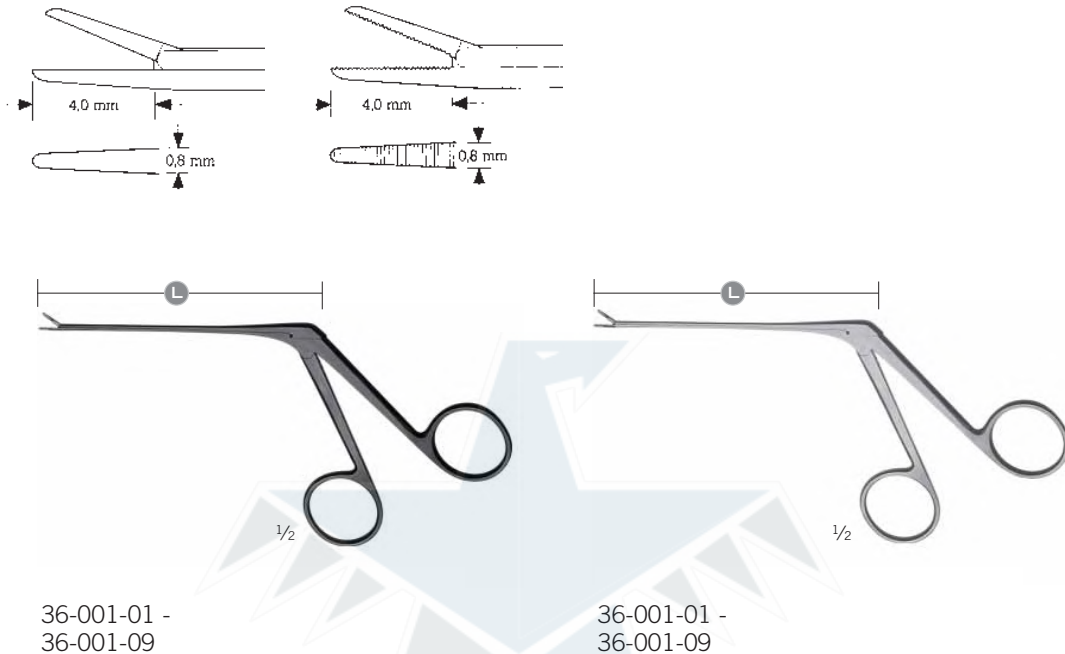

36-001-01 -
36-001-09

36-001-01 -
36-001-09

	gerade, glatt straight, smooth recta, lisa droite, lisse retta, liscia	gerade, gerieft straight, serrated recta, estriada droite, striée retta, con scanalatura	aufgebogen, gerieft bent upwards, serrated curva por arriba, estriada courbée v. le haut, striée curva in alto, con scanalatura	rechts, gerieft right, serrated derecha, estriada droite, striée destra, con scanalatura	links, gerieft left, serrated izquierda, estriada gauche, striée sinistra, con scanalatura
1/1					
L	8 cm	8 cm	8 cm	8 cm	8 cm
SB	36-001-01	36-001-06	36-001-07	36-001-08	36-001-09
St	36-001-01	36-001-06	36-001-07	36-001-08	36-001-09

Micro Ear Forceps

Mikro-Ohrzängchen
 Micro pinzas auriculares
 Micro Pince auriculaires
 Micro Pinze auricolari

Otology

Otologie
 Otologia
 Otologie
 Otologia

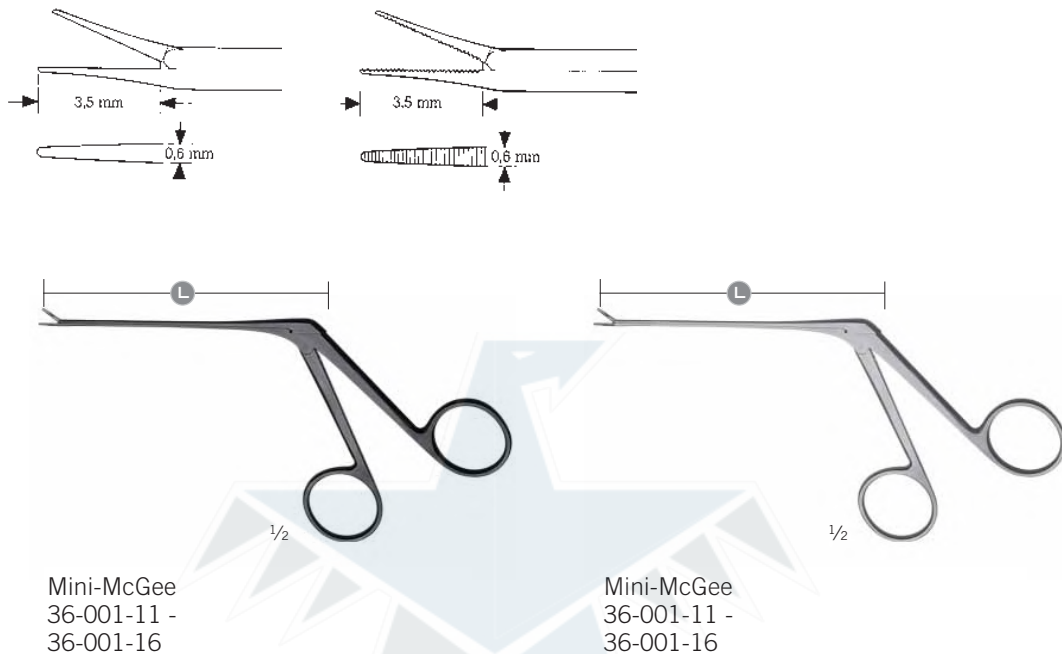

	gerade, glatt straight, smooth recta, lisa droite, lisse retta, liscia	gerade, gerieft straight, serrated recta, estriada droite, striée retta, con scanalatura
1/1		
L	8 cm	8 cm
SB	36-001-11	36-001-16
St	36-001-11	36-001-16



Micro Ear Forceps

Mikro-Ohrzangchen
Micro pinzas auriculares
Micro Pince auriculaires
Micro Pinze auricolari

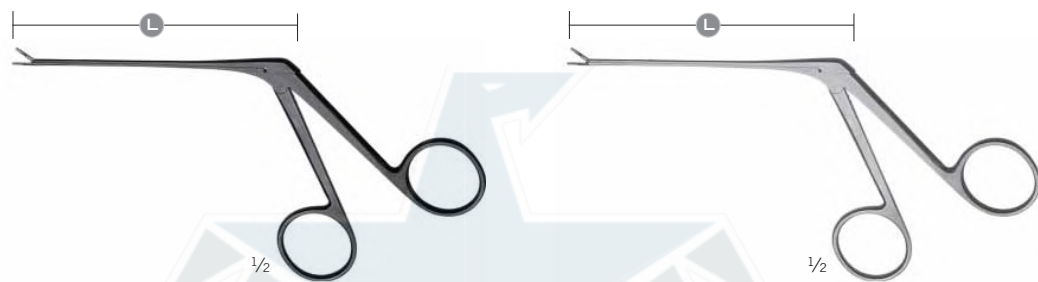
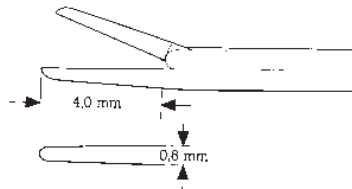

36-001-21

36-001-21

gerade, glatt
straight, smooth
recta, lisa
droite, lisse
retta, liscia



L 8 cm

SB 36-001-21

St 36-001-21



Micro Ear Forceps

Mikro-Ohrzängchen
 Micro pinzas auriculares
 Micro Pince auriculaires
 Micro Pinze auricolari

Otology

Otologie
 Otología
 Otologie
 Otologia

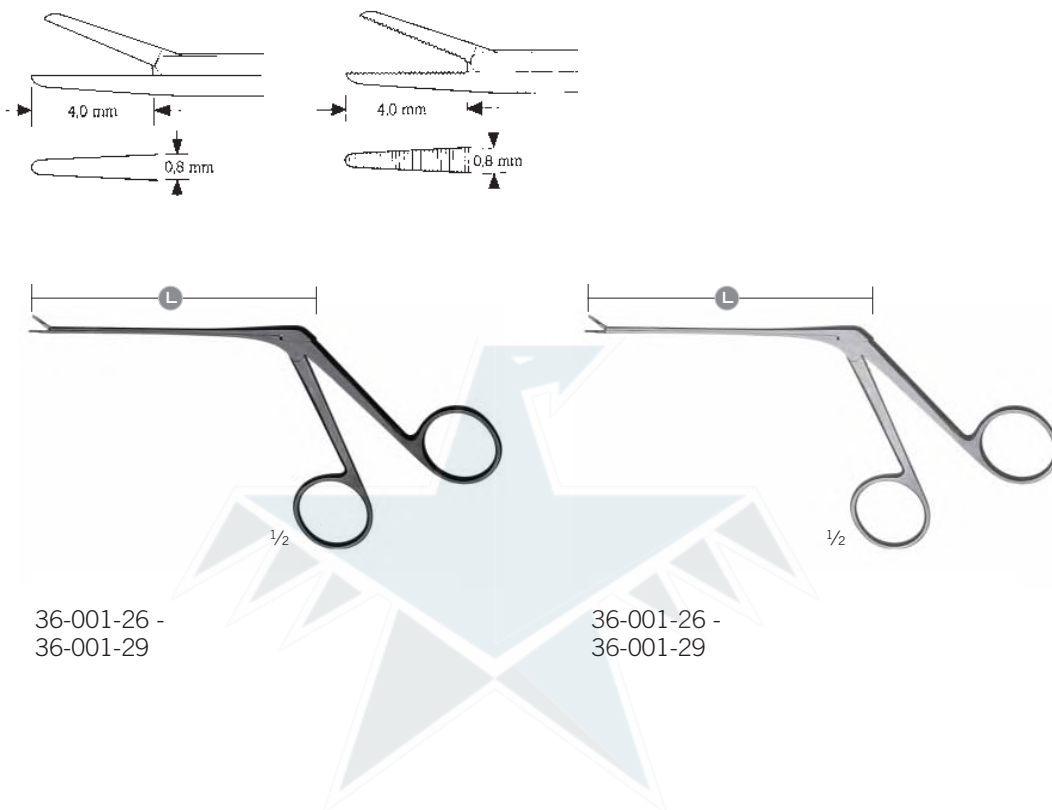
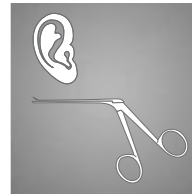

	gerade, gerieft straight, serrated recta, estriada droite, striée retta, con scanalatura	aufgebogen, gerieft bent upwards, serrated curva por arriba, estriada courbée v. le haut, striée curva in alto, con scanalatura	rechts, gerieft right, serrated derecha, estriada droite, striée destra, con scanalatura	links, gerieft left, serrated izquierda, estriada gauche, striée sinistra, con scanalatura
1/1				
L	8 cm	8 cm	8 cm	8 cm
SB	36-001-26	36-001-27	36-001-28	36-001-29
St	36-001-26	36-001-27	36-001-28	36-001-29



Micro Ear Forceps

Mikro-Ohrzängchen
 Micro pinzas auriculares
 Micro Pince auriculaires
 Micro Pinze auricolari

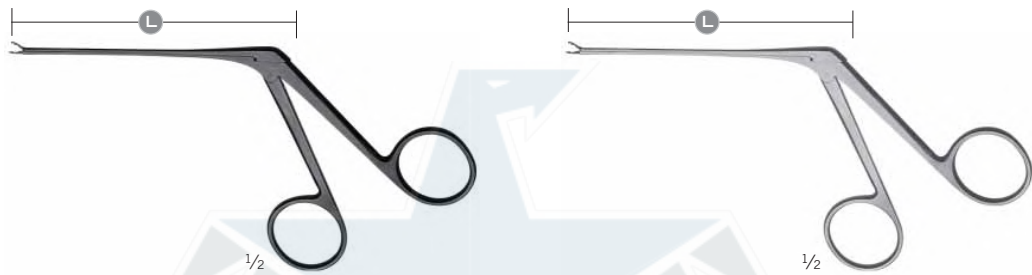
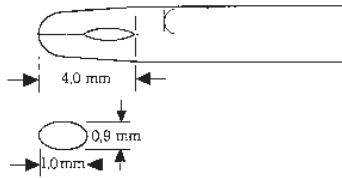

36-003-01 -
 36-003-04

Löffel
 cup
 cucharilla
 curette
 cucchiaio

36-003-01 -
 36-003-04

Löffel
 cup
 cucharilla
 curette
 cucchiaio

	gerade straight recta droite retta	aufgebogen bent upwards curva por arriba courbée en haut curva in alto	rechts right derecha droite destra	links left izquierda gauche sinistra
1/1				
L	8 cm	8 cm	8 cm	8 cm
SB	36-003-01	36-003-02	36-003-03	36-003-04
St	36-003-01	36-003-02	36-003-03	36-003-04

Micro Ear Forceps

Mikro-Ohrzängchen
 Micro pinzas auriculares
 Micro Pince auriculaires
 Micro Pinze auricolari

Otology

Otologie
 Otologia
 Otologie
 Otologia

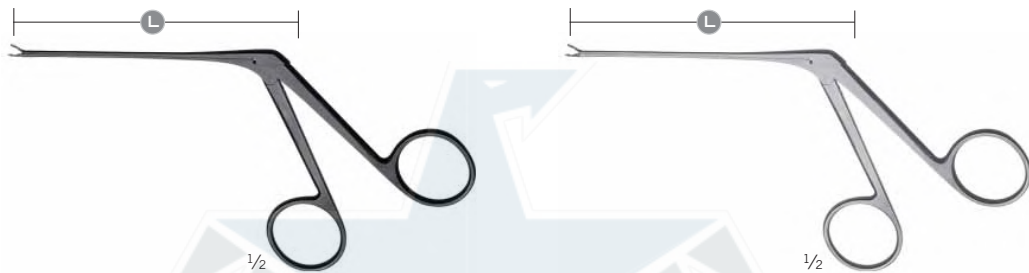
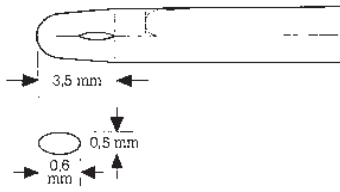
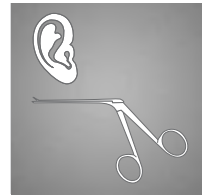

Mini-McGee
 36-003-11 -
 36-003-14

Löffel
 cup
 cucharilla
 curette
 cucchiaio

Mini-McGee
 36-003-11 -
 36-003-14

Löffel
 cup
 cucharilla
 curette
 cucchiaio

	gerade straight recta retta	aufgebogen bent upwards curva por arriba courbée en haut curva in alto	rechts right derecha destra	links left izquierda sinistra
1/1				
L	8 cm	8 cm	8 cm	8 cm
SB	36-003-11	36-003-12	36-003-13	36-003-14
St	36-003-11	36-003-12	36-003-13	36-003-14



Micro Ear Forceps

Mikro-Ohrzängchen
 Micro tijeras auriculares
 Micro Ciseaux auriculaires
 Micro Forbici auricolari

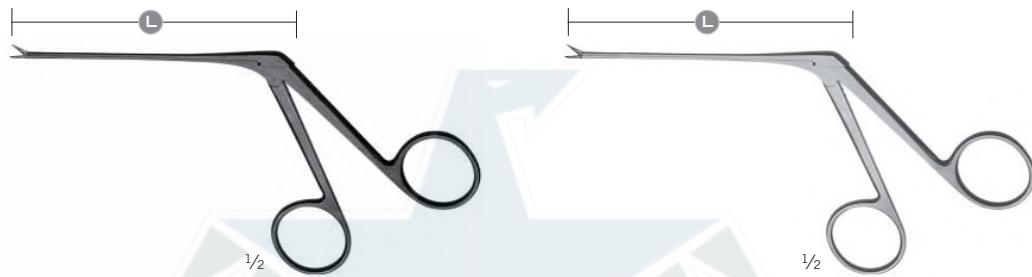
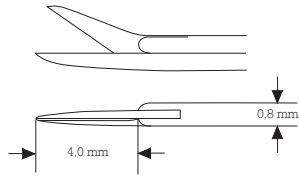

Bellucci
 22-104-01
 22-104-04

sehr fein
 very delicate
 muy fino
 très fin
 strafino

Bellucci
 36-005-01 -
 36-005-04

sehr fein
 very delicate
 muy fino
 très fin
 strafino

	gerade straight recta droite retta	aufgebogen bent upwards curva por arriba courbée en haut curva in alto	rechts right derecha droite destra	links left izquierda gauche sinistra
1/1				
L	8 cm	8 cm	8 cm	8 cm
SB	36-005-01	36-005-02	36-005-03	36-005-04
St	36-005-01	36-005-02	36-005-03	36-005-04

Micro Ear Scissors

Mikro-Ohrscherchen
 Micro tijeras auriculares
 Micro Ciseaux auriculaires
 Micro Forbici auricolari

Otology

Otologie
 Otologia
 Otologie
 Otologia

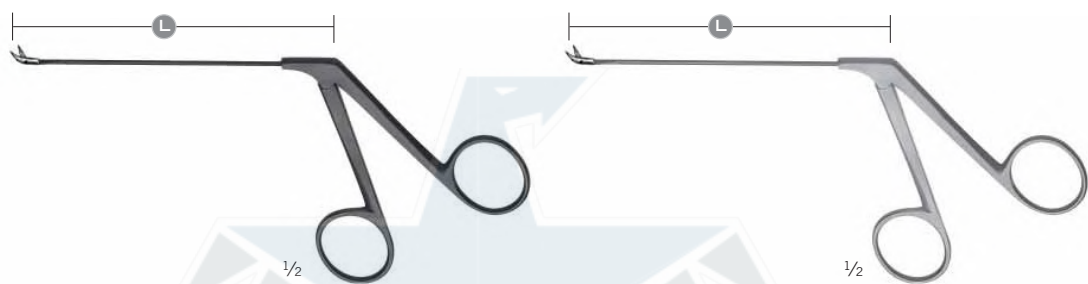
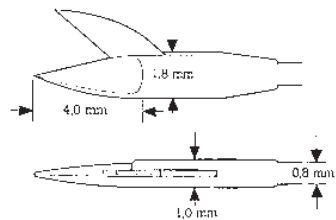
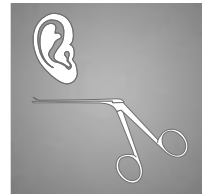

Wullstein
 22-104-31
 22-104-34

Wullstein
 36-005-51 -
 36-005-54

	gerade straight recta rette	aufgebogen bent upwards curva por arriba courbée en haut curva in alto	rechts right derecha droite destra	links left izquierda gauche sinistra
1/1				
L	9 cm	9 cm	9 cm	9 cm
SB	36-005-51	36-005-52	36-005-53	36-005-54
St	36-005-51	36-005-52	36-005-53	36-005-54



Micro Ear Forceps

Mikro-Ohrzängchen
 Micro pinzas auriculares
 Micro Pince auriculaires
 Micro Pinze auricolari

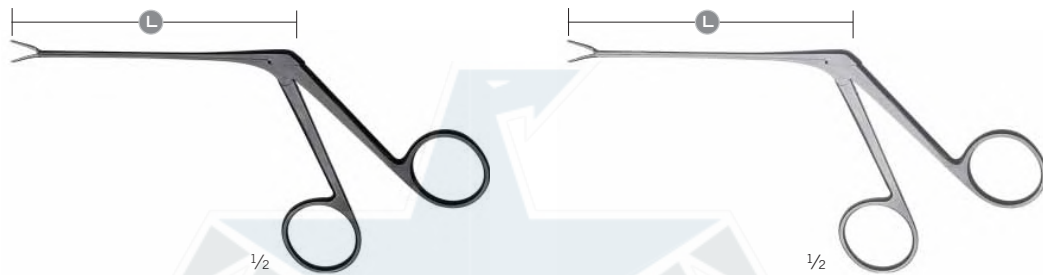
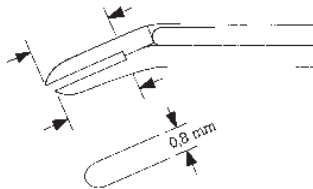

McGee
 22-110-11
 22-110-12

Drahtbiegezängchen
 Wire Bending Forceps
 Pinza para plegar alambre
 Pince à plier les fils d'acier
 Pinza per piegare fili metallici

McGee
 36-010-11 -
 36-010-12

Drahtbiegezängchen
 Wire Bending Forceps
 Pinza para plegar alambre
 Pince à plier les fils d'acier
 Pinza per piegare fili metallici

	abgewinkelt angled downward acodado abajo angulé vers le bas angolato verso il basso	abgewinkelt angled downward acodado abajo angulé vers le bas angolato verso il basso
1/1	<p>0,8 x 3,5 mm</p>	<p>0,8 x 6,0 mm</p>
L	8 cm	8 cm
SB	36-010-11	36-010-12
St	36-010-11	36-010-12

Micro Ear Forceps

Mikro-Ohrzängchen
 Micro pinzas auriculares
 Micro Pince auriculaires
 Micro Pinze auricolari

Otology

Otologie
 Otologia
 Otologie
 Otologia

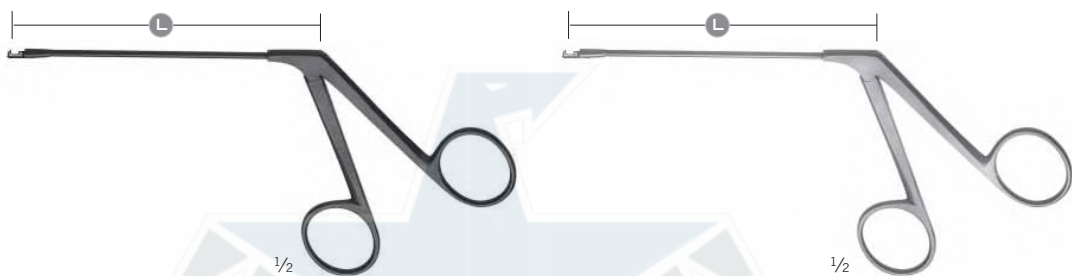
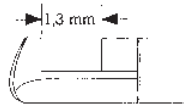

House-Dieter
 22-112-01
 22-112-02
 Hammerkopfzängchen
 Malleus Nipper
 Pinza para cabezal del maléolo
 Pince pour l'os marteau
 Pinza per testa del martelletto

House-Dieter
 22-112-01
 22-112-07
 Hammerkopfzängchen
 Malleus Nipper
 Pinza para cabezal del maléolo
 Pince pour l'os marteau
 Pinza per testa del martelletto

	oben schneidend up-cutting corte arriba tranchante en haut tagliente in alto	unten schneidend down-cutting corte abajo tranchante en bas tagliente in basso	rechts schneidend right-cutting corte derecho tranchant à droite tagliente a destra	links schneidend left-cutting corte izquierdo tranchant à gauche tagliente a sinistra
1/1				
L	9 cm	9 cm	9 cm	9 cm
SB	36-011-01	36-011-02	36-011-06	36-011-07
St	36-011-01	36-011-02	36-011-06	36-011-07



Micro Ear Forceps

Mikro-Ohrzängchen
Micro pinzas auriculares
Micro Pince auriculaires
Micro Pinze auricolari

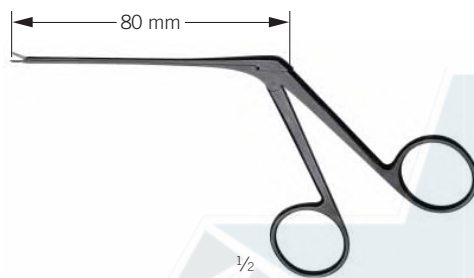
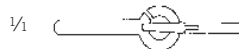

Fuller
22-114-01

SB
Einführungszängchen, für Teflonprothesen
Introducing Forceps, for teflon prosthesis
Pinza para introducir, para prótesis de teflon
Pince pour introduction, pour prothèse en téflon
Pinza per introduzione, per protesi in teflon

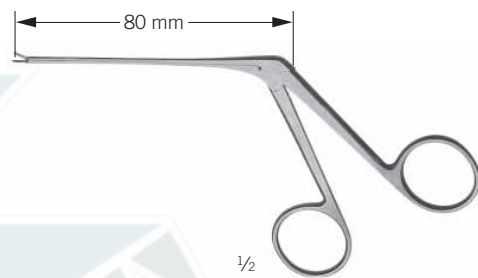

Fuller
36-013-01

St
Einführungszängchen, für Teflonprothesen
Introducing Forceps, for teflon prosthesis
Pinza para introducir, para prótesis de teflon
Pince pour introduction, pour prothèse en téflon
Pinza per introduzione, per protesi in teflon

Empire



Micro Ear Knives

Mikro-Ohrmesser
 Micro cuchillos auriculares
 Micro Couteaux auriculaires
 Micro Coltelli

Otology

Otologie
 Otologia
 Otologie
 Otologia

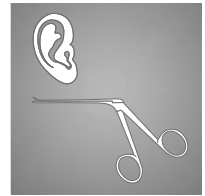

Schuknecht
 22-160-03
 15,5 cm / 6 1/8"
 Sichelmesser
 Sickle Knife
 Cuchillo de hoz
 Synéchiotome
 Coltello falcato
 come sinechia

Wullstein
 22-160-11
 15,5 cm / 6 1/8"
 Sichelmesser
 Sickle Knife
 Cuchillo de hoz
 Synéchiotome
 Coltello falcato
 come sinechia

Tabb
 22-160-51
 15,5 cm / 6 1/8"
 Schleimhautmesser
 Mucosa Knife
 Cuchillo para mucosa
 Couteau pour muqueuse
 Bisturi per mucosa

Plester
 36-020-21
 15 cm / 5 7/8"
 Lappenmesser
 Flap Knife
 Cuchillo para lóbulos
 Couteau lobaire
 Coltello per lobi

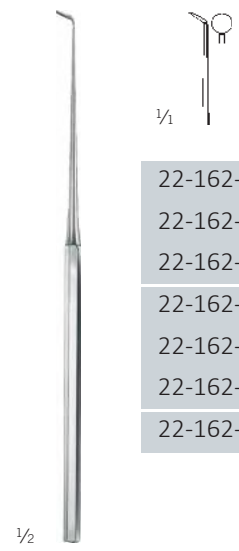

Rosen
 22-162-01
 22-162-07
 15 cm / 5 7/8"

22-162-01	Fig. 1	∅ 3,0 mm	
22-162-02	Fig. 2	∅ 2,8 mm	
22-162-03	Fig. 3	∅ 2,6 mm	
22-162-04	Fig. 4	∅ 2,0 mm	
22-162-05	Fig. 5	∅ 1,6 mm	
22-162-06	Fig. 6	∅ 1,4 mm	
22-162-07	Fig. 7	∅ 1,0 mm	



Micro Ear Hooks, Micro Ear Needles

Mikro-Ohrhäkchen, Mikro-Ohrnadeln
 Micro ganchitos auriculares, Micro agujas auriculares
 Micro Crochets auriculaires, Micro Aiguilles auriculaires
 Micro Uncini auricolari, Micro Aghi auricolari



1/1
Barbara
22-164-01



Barbara
22-164-02



Barbara
22-164-03



Rosen
22-164-04



1/1
25°
Haken
hook
gancho
crochet
gancio



45°
Haken
hook
gancho
crochet
gancio



90°
Haken
hook
gancho
crochet
gancio



22-164-06	0,3 mm	22-164-11	0,3 mm	22-164-21	0,3 mm	22-164-31	0,5 mm
22-164-07	0,6 mm	22-164-12	0,6 mm	22-164-22	0,6 mm	22-164-32	1,0 mm
22-164-08	1,0 mm	22-164-13	1,0 mm	22-164-23	1,0 mm		
		22-164-14	1,2 mm	22-164-24	1,2 mm		
		22-164-15	1,5 mm	22-164-25	1,5 mm		
		22-164-16	2,0 mm	22-164-26	2,0 mm		
		22-164-17	2,5 mm	22-164-27	2,5 mm		



1/2
22-164-01
22-164-32
16 cm / 6 2/8"

Micro Ear Hooks, Micro Ear Needles

Mikro-Ohrhäkchen, Mikro-Ohrnadeln
 Micro ganchitos auriculares, Micro agujas auriculares
 Micro Crochets auriculaires, Micro Aiguilles auriculaires
 Micro Uncini auricolari, Micro Aghi auricolari

Otology

Otologie
 Otologia
 Otologie
 Otologia

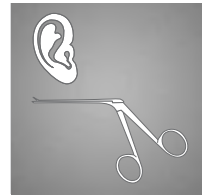

1/2

36-025-01 -
 36-027-08
 15,5 cm / 6 1/8"



1/1

aufgewinkelt
 bent upwards
 angulado hacia arriba
 coudé en haut
 angolato in alto
90°



abgewinkelt
 angled
 angulada
 coudée
 angolata
90°



aufgebogen
 bent upwards
 angulado hacia arriba
 coudé en haut
 angolato in alto



abgewinkelt
 angled
 angulada
 coudée
 angolata

36-025-01	0,3 mm
36-025-02	0,6 mm
36-025-03	1,0 mm

36-025-06	0,3 mm
36-025-07	0,6 mm
36-025-08	1,0 mm

McGee

36-027-01	0,5 mm
36-027-02	1,0 mm

McGee

36-027-11	0,5 mm
36-027-12	1,0 mm

für Fußplatte
 for footplate
 para la platina estapediense
 pour la platine de l'étrier
 per la piedistallo

für Fußplatte
 for footplate
 para la platina estapediense
 pour la platine de l'étrier
 per la piedistallo



Empire



1/2

Barbara
 22-170-01
 22-178-01
 15,5 cm / 6 1/8"

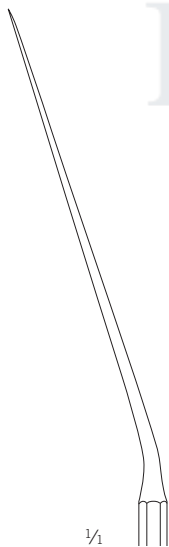

1/1

36-029-01

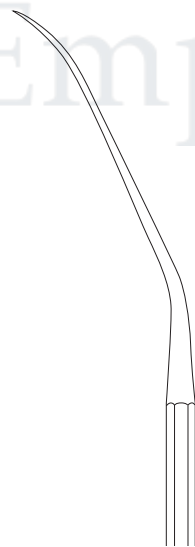

36-029-06





Micro Ear Hooks, Micro Ear Dissectors

Mikro-Ohrhäkchen, Mikro-Dissektoren
 Micro ganchitos auriculares, Micro disecadores
 Micro Crochets auriculaires, Micro Dissecteurs
 Micro Uncini auricolari, Micro Dissettori



1/2

36-030-06 -
 36-030-30
 15 cm / 5 7/8"

<p>25° Haken hook gancho crochet gancio 0,3 mm</p>	<p>25° Haken hook gancho crochet gancio 0,6 mm</p>	<p>25° Haken hook gancho crochet gancio 1,0 mm</p>	<p>45° Haken hook gancho crochet gancio 0,3 mm</p>
36-030-06	36-030-07	Shambaugh 36-030-08	36-030-11

<p>45° Haken hook gancho crochet gancio 0,6 mm</p>	<p>45° Haken hook gancho crochet gancio 1,0 mm</p>	<p>45° Sondierhaken Exploring Hook Ganchito explorador Crochet à exploration uncino di sondaggio 2,0 mm stumpf blunt romo mousse smusso</p>	<p>90° Attikusdissektor Attic Dissector Disecador para el ático Dissecteur pour l'attique Dissettori per l'attico 3,0 mm stumpf blunt romo mousse smusso</p>
36-030-12	Shambaugh 36-030-13	Shea 36-030-20	Austin 36-030-30



1/2

Fisch
 22-190-01
 22-190-06

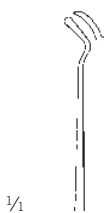

1/4

22-190-01
 15 cm / 5 7/8"
 nach rechts abgewinkelt
 angled to right
 angulada por derecha
 coudée vers droite
 angulata a destra



22-190-02
 15 cm / 5 7/8"
 nach links abgewinkelt
 angled to left
 angulada por izquierda
 coudée vers gauche
 angulata a sinistra



22-190-03
 15,5 cm / 6 1/8"
 nach rechts abgewinkelt
 angled to right
 angulada por derecha
 coudée vers droite
 angulata a destra



22-190-04
 15,5 cm / 6 1/8"
 nach links abgewinkelt
 angled to left
 angulada por izquierda
 coudée vers gauche
 angulata a sinistra

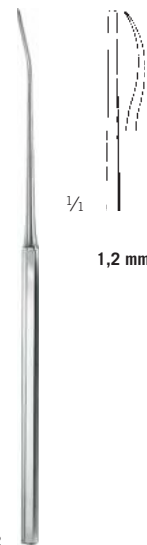

1/2

Rosen
 36-036-23
 15 cm / 5 7/8"
 Mikro-Ohrraspatorium
 Micro Ear Periosteal Elevator
 Micro Legra auricular
 Micro Rugine-Raspatoire auriculaire
 Micro Raspatore auricolare



Micro Curettes, Micro Measuring Rods

Mikro-Küretten, Mikro-Messsonden
 Micro cucharillas, Micro Sondas para medir
 Micro Curettes, Micro Sondes pour mesurer
 Micro cucchiari, Micro Sonde per misurare

Otology

Otologie
 Otologia
 Otologia
 Otologia

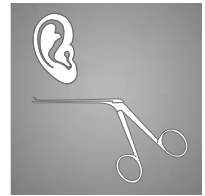

1/2

House
 22-192-35
 22-192-04
 15,5 cm / 6 1/8"



1/4

22-192-35

Markierung bis
 Marking up to
 Manchar hasta
 Marquage jusque
 Marcatura fino a
3,5 mm



22-192-40

Markierung bis
 Marking up to
 Manchar hasta
 Marquage jusque
 Marcatura fino a
4,0 mm



22-192-45

Markierung bis
 Marking up to
 Manchar hasta
 Marquage jusque
 Marcatura fino a
4,5 mm



22-192-50

Markierung bis
 Marking up to
 Manchar hasta
 Marquage jusque
 Marcatura fino a
5,0 mm



Empire



1/2

House
 22-221-01
 22-221-02
 14,5 cm / 5 9/16"



∅ 1,0 mm

22-221-01

∅ 1,2 mm

1/4



∅ 1,5 mm

22-221-02

∅ 1,8 mm

1/4





Ear Specula
 Ohrspekula
 Espéculos auriculares
 Spéculums auriculaires
 Specoli auricolari

St



Fig. 0	Fig. 1	Fig. 2	Fig. 3	Fig. 4
Ø 3,0 mm	Ø 4,0 mm	Ø 5,0 mm	Ø 6,0 mm	Ø 7,5 mm
22-409-00	22-409-01	22-409-02	22-409-03	22-409-04

Hartmann
 22-409-03
 22-409-04
 3,6 cm / 1 3/8"

Fig. 0 - 2	Fig. 2 - 4	Fig. 1 - 4
36-112-03	36-114-03	36-115-04
Ohrspekula, Satz, Ear Specula, set Espéculos auriculares, juego Spéculums auriculaires, jeu Specoli auricolari, set für Kinder for children para niños pour enfants per bambini	Ohrspekula, Satz, Ear Specula, set Espéculos auriculares, juego Spéculums auriculaires, jeu Specoli auricolari, set für Erwachsene for adults para adultos pour adultes per adulti	Ohrspekula, Satz, Ear Specula, set Espéculos auriculares, juego Spéculums auriculaires, jeu Specoli auricolari, set für Erwachsene for adults para adultos pour adultes per adulti

St



Fig. 1	Fig. 2	Fig. 3	Fig. 4
Ø 4,0 mm	Ø 5,0 mm	Ø 6,0 mm	Ø 7,5 mm
22-415-01	22-415-02	22-415-03	22-415-04

Toynbee
 22-415-01
 22-415-04
 3,6 cm / 1 3/8"

Fig. 2 - 4	Fig. 1 - 4
36-118-03	36-119-04
Ohrspekula, Satz, Ear Specula, set Espéculos auriculares, juego Spéculums auriculaires, jeu Specoli auricolari, set für Erwachsene for adults para adultos pour adultes per adulti	Ohrspekula, Satz, Ear Specula, set Espéculos auriculares, juego Spéculums auriculaires, jeu Specoli auricolari, set für Erwachsene for adults para adultos pour adultes per adulti

Ear Specula

Ohrspekula
Espéculos auriculares
Spéculums auriculaires
Specoli auricolari

Otology

Otologie
Otología
Otologie
Otologia

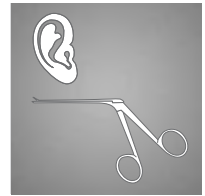

A1



1/2



Fig. 1	Fig. 2	Fig. 3	Fig. 4	Fig. 5	Fig. 6
5,5 x 6,5 mm	6,5 x 7,5 mm	7,5 x 8,5 mm	8,5 x 9,5 mm	9,5 x 10,5 mm	10,5 x 11,5 mm
22-421-01	22-421-02	22-421-03	22-421-04	22-421-05	22-421-06

Zöllner
22-421-00
22-421-06

3,8 cm / 1 4/8"
oval, schwarz
oval, black
ovalado, negro
ovale, noire
ovale, nero

Fig. 1 - 6
22-421-00
Ohrspekula, Satz,
Ear Specula, set
Espéculos auriculares, juego
Spéculums auriculaires, jeu
Specoli auricolari, set

St
15/6



1/2



Fig. 1	Fig. 2	Fig. 3	Fig. 4	Fig. 5	Fig. 6	Fig. 7
∅ 5,5 mm	∅ 6,5 mm	∅ 7,5 mm	∅ 8,5 mm	∅ 9,5 mm	∅ 10,5 mm	∅ 11,5 mm
22-432-45	22-432-50	22-432-55	22-432-60	22-432-65	22-432-70	22-432-75

Farrior
22-432-45
22-432-75

3,6 cm / 1 3/8"
rund, schwarz
round, black
redondo, negro
ronde, noire
rotondo, nero



1/2

36-148-12

Ohrspekulaständer
Ear Specula Storage Rack
Soporte para espéculos auriculares
Support pour spéculums auriculaires
Supporto per specoli auricolari





Tuning Forks

Stimmgabeln
Diapasónes
Diapasons
Diapason



1/2

French
22-480-01

C₂ 16



1/2

French
22-480-02

C₁ 32



1/2

Hartmann
22-484-01

C 64



1/2

Hartmann
22-484-02

C 128



1/2

Hartmann
22-484-03

C¹ 256



Tuning Forks

Stimmgabeln
Diapasónes
Diapasons
Diapason

Otology

Otologie
Otologia
Otologie
Otologia



1/2

Martin
36-180-10
c 128



1/2

Martin
36-182-11
c 256



1/2

Martin-Alloy
36-184-12
c 512



1/2

Martin-Alloy
36-186-13
c 1024



1/2

Martin-Alloy
36-188-14
c 2048



1/2

Hartmann
22-492-01
c 128



1/2

Hartmann
22-492-02
c1 256



1/2

Hartmann
22-492-02
c2 512



1/2

Hartmann
22-492-05
c3 1024



1/2

Hartmann
22-492-05
c4 2048



1/2

Hartmann
22-492-06
c5 4096



Tuning Forks

Stimmgabeln
Diapasónes
Diapasons
Diapason



Lucae
22-496-01
C 128

1/2



Lucae
22-496-02
C¹ 256

1/2



Lucae
22-496-03
C² 512

1/2



Lucae
22-496-04
C³ 1024

1/2



Lucae
22-496-05
C⁴ 2048

1/2



Lucae
22-496-06
C⁵ 4096

1/2

36-216-90-98

Fuss, allein
Socket, only
Pedestal, suelto
Socle, seul
Zoccolo, solo



22-524-00

Fuss, allein
Socket, only
Pedestal, suelto
Socle, seul
Zoccolo, solo

1/1

Lucae
22-524-00
C 128

verschiebbar bis h
moveable up to h
regulable hasta h
réglable jusqu'à h
regolabile fino a h



Hartmann
22-524-00

C 128

verschiebbar bis h
moveable up to h
regulable hasta h
réglable jusqu'à h
regolabile fino a h

1/2



Hartmann
22-528-00

C¹ 256

Fuss, allein
Socket, only
Pedestal, suelto
Socle, seul
Zoccolo, solo

1/2



Tuning Forks

Stimmgabeln
Diapasones
Diapasons
Diapason

Otology

Otologie
Otológia
Otologie
Otologia

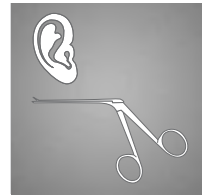

36-224-90

Dämpfer
Dampfer
Sordina
Curseur
Sordina
weiße Skala
white scale
balanza blanca
l'échelle graduée blanche
scala bianca



36-224-10

36-224-91

Dämpfer
Dampfer
Sordina
Curseur
Sordina
schwarze Skala
black scale
balanza negra
l'échelle graduée noire
scala nera



36-224-10

36-224-92

Rändelschraube
Knurled screw
Tornillo moleteado
Vis moletée Vite a
testa zigrinata



36-224-10

36-224-93

Gewichte, C 64
Weights, C 64
Pesas, C 64
Poids, C 64
Pesi, C 64



36-224-10



1/2

1/2

1/2

1/2

Rydel-Seiffert
36-224-10
C 64 / c 128

auch für Neurologie
also for neurology
también para neurología
aussi pour la neurologie
anche per neurologia

Neuro
36-226-00

mit Hammer, Nadelrad, Pinsel und Nadel
with hammer, pinwheel, brush and needle
con martillo, rueda con espinas, cepillo y aguja
avec marteaux, roue aux épingles, brosette et aiguille
con martello, algesimetro, pennello ed ago

König
36-230-59
A 109

verschiebbar bis g
moveable up to g
regulable hasta g
réglable jusqu'à g
regolabile fino a g

36-234-90

Bakelitfuss
Bakelit base
Base de Bakelit
Base di Bakelit



36-234-61

36-234-61
a¹ 440





Ear Catheters, Polypus Snares

Ear Catheters, Polypus Snares
 Sondas auriculares, Polipótomos
 Sondes auriculaires, Serre-noeuds
 Sonde auricolare, Serranodi



1/1

Fig. 1

Ø 3,0 mm
 22-550-01

1/1

Fig. 2

Ø 3,5 mm
 22-550-02

1/1

Fig. 3

Ø 4,0 mm
 22-550-03

1/2

Hartmann
 22-550-01
 22-550-03
 15 cm / 5 7/8"



1/2

36-316-11
 Schaftlänge
 shaft length
 longitud del vástago
 longueur de la tige
 lunghezza dell'asta
110 mm



1/1

1/2

Krause
 22-571-16
 18,5 cm / 7 3/8"
 offenes Ende
 open tip
 punta abierta
 pointe ouverte
 punta aperta



1/1

1/2

Krause-Voss
 22-573-16
 18,5 cm / 7 3/8"
 geschlossenes Ende
 closed tip
 punta cerrada
 pointe fermée
 punt chiusa

36-353-90
 Polypenschnürer
 Polypus Snares
 Polipótomos
 Serre-noeuds
 Serranodi
 → 36-353-16



1/2

22-578-30
 Ø 0,3 mm
 22-578-40
 Ø 0,4 mm

36-358-30 -
 36-358-40
 → 36-351-16,
 36-353-16
 Schnürdraht, Rolle mit 10 m
 Snare Wire, coil of 10 m
 Alambre, rollo de 10 m
 Serre-noeuds, en rouleaux de 10 m
 Filo in acciaio, rotolo di 10 m

Ear Forceps

Ohrpinzetten
Pinzas auriculares
Pincès auriculaires
Pinze auricolari

Otology

Otologie
Otologia
Otologia
Otologia

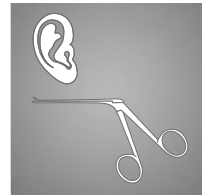

Tröltzsch (Wilde)
22-601-11
10,5 cm / 4 1/8"



Tröltzsch (Wilde)
22-603-12
11 cm / 4 3/8"



Tröltzsch (Wilde)
22-605-13
12,5 cm / 4 7/8"



Grünwald
36-391-14
14,5 cm / 5 9/16"



Jansen
22-609-16
16 cm / 6 2/8"
22-609-20
21,5 cm / 8 1/8"



Ear Polypus Forceps

Ohrpolypenzangen
Pinzas para pólipos auriculares
Pincés pour polypes auriculaires
Pinze per polipi auricolari

1/1



Hartmann
36-405-12

feines Modell
delicate pattern
modelo delicado
modèle fin
modello fino

Schaftlänge
shaft length
longitud del vástago
longueur de la tige
lunghezza dell'asta
65 mm

1/1



Hartmann
36-407-14

normales Modell
regular model
modelo regular
modèle normal
modello normale

Schaftlänge
shaft length
longitud del vástago
longueur de la tige
lunghezza dell'asta
65 mm

Empire

1/1



Buck
22-632-11

11,5 cm / 4 1/8"

Fremdkörperzängchen
Foreign Body Lever
Elevador para cuerpos extraños
Pince pour polypes auriculaires
Pinza per corpi estranei

1/1



Quire
22-636-10

10,5 cm / 4 1/8"

Fremdkörperhebel
Foreign Body Lever
Elevador para cuerpos extraños
Pince pour corps étrangers
Leva per corpi estranei



Ear Polypus Forceps

Ohrpolypenzangen
 Pinzas para pólipos auriculares
 Pincas pour polypes auriculaires
 Pinze per polipi auricolari

Otology

Otologie
 Otologia
 Otologie
 Otologia

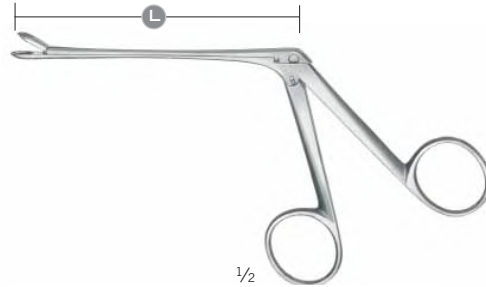
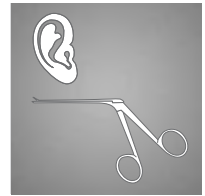

36-425-08 -
 36-456-08

	Hartmann-Wullstein	Hartmann-Wullstein	
1/1			
L	8,5 cm 36-425-08	8,5 cm 36-427-08	
	Hartmann	Hartmann	Hartmann
1/1			
L	8,5 cm 36-430-08	14 cm 36-430-14	8,5 cm 36-431-08
	Hartmann-Herzfeld	Hartmann-Herzfeld	Hartmann-Herzfeld
1/1	 ○ Ø 2,0 mm	 ○ Ø 2,5 mm	 ○ Ø 3,0 mm
L	8,5 cm 36-442-81	8,5 cm 36-442-82	8,5 cm 36-442-83
	Hartmann-Wullstein	Strümpel	Hartmann-Hoffmann durchschneidend through-cutting cortante tranchante tagliante
1/1	 ○ Ø 3,0 mm	 ○ Ø 2,0 mm	 ○ Ø 2,0 mm
L	8,5 cm 36-445-08	8,5 cm 36-448-08	8,5 cm 36-456-08





Mastoid Rongeurs

Ohr-Knochenstanzen
 Pinzas cortantes para huesos
 Ostéotomes emporte-pièces
 Pinze osteotomi

L



1/2

Citelli
 22-694-17

Maulbreite Jaw width Anchura de la boca Largeur de mors Larghezza della bocca	aufgewinkelt angled upward acodado arrib angulé vers le haut angolato verso l'alto
3 mm	L 7,5 cm
	36-461-17

Mastoid Rongeurs

Ohr-Knochenstanzen
 Pinzas cortantes para huesos
 Ostéotomes emporte-pièces
 Pinze osteotomi

Otology

Otologie
 Otologia
 Otologie
 Otologia

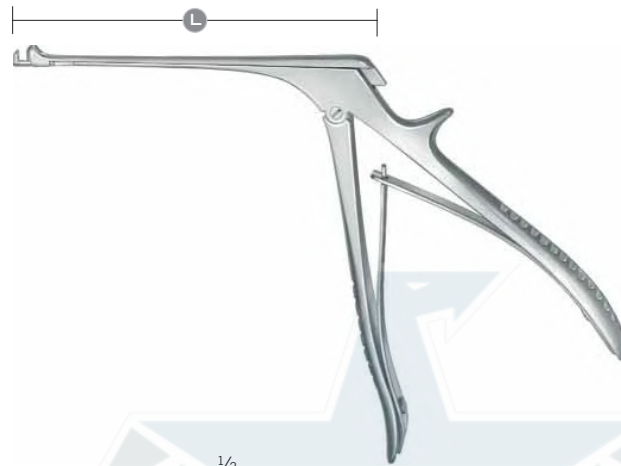
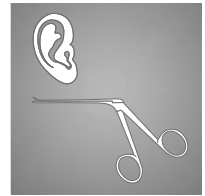

1/2

Beyer
 22-698-19
 22-702-14

Maulbreite Jaw width Anchura de la boca Largeur de mors Larghezza della bocca	aufgewinkelt angled upward acodado arrib angulé vers le haut angolato verso l'alto	1/1	
		L	9,5 cm
1 mm		22-702-14	
2 mm		22-698-19	



Ear Curettes

Ohrküretten
Curetas auriculares
Curettes auriculaires
Curette auricolari



Langenbeck
22-731-13

13 cm / 5 1/8"
stumpf
blunt
romo
mousse
smusso

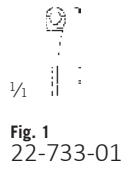

Fig. 1
22-733-01



Fig. 2
22-733-02

Shapleigh
22-733-01
22-733-02
15 cm / 5 7/8"



Buck
36-495-02 -
36-495-12
17 cm / 6 5/8"
stumpf
blunt
romo
mousse
smusso

36-495-02	Fig. 00	∅ 2,1 mm
36-495-10	Fig. 0	∅ 2,6 mm
36-495-11	Fig. 1	∅ 3,2 mm
36-495-12	Fig. 2	∅ 3,7 mm



Buck
22-736-01
22-737-14
15 cm / 6 5/8"

stumpf blunt romo mousse smusso		
22-736-01	Fig. 000	∅ 1,8 mm
22-736-02	Fig. 00	∅ 2,1 mm
22-736-10	Fig. 0	∅ 2,6 mm
22-736-11	Fig. 1	∅ 3,2 mm
22-736-12	Fig. 2	∅ 3,7 mm
22-736-13	Fig. 3	∅ 4,1 mm
22-736-14	Fig. 4	∅ 4,4 mm

scharf sharp agudo pointu acuto		
22-737-01	Fig. 000	∅ 1,8 mm
22-736-02	Fig. 00	∅ 2,1 mm
22-736-10	Fig. 0	∅ 2,6 mm
22-736-11	Fig. 1	∅ 3,2 mm
22-736-12	Fig. 2	∅ 3,7 mm
22-736-13	Fig. 3	∅ 4,1 mm
22-736-14	Fig. 4	∅ 4,4 mm



Ear Scoop, Foreign Body Instruments

Ohrlöffel, Fremdkörperinstrumente
 Cucharilla auricular, Instrumentos para cuerpos extraños
 Curette auriculaire, Instruments pour corps étrangers
 Curetta auricolare, Strumenti per corpi estranei

Otology

Otologie
 Otología
 Otologie
 Otologia



Jansen
 36-532-15
 16 cm / 6 2/8"
 scharf
 sharp
 agudo
 pointu
 acuto

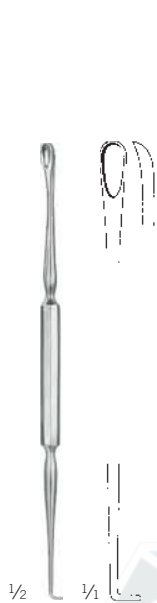

Gross
 36-543-12
 13 cm / 5 1/8"
 stumpf
 blunt
 romo
 mousse
 smusso



Weber-Loch
 36-551-01
 17 cm / 6 5/8"



Billeau
 36-554-01 -
 36-554-03
 16,5 cm / 6 4/8"



Moldenhauer
 36-561-16
 16 cm / 6 1/8"
 Fremdkörperhebel
 Foreign Body Lever
 Elevador para cuerpos extraños
 Anse auriculaire
 Leva per corpi estranei

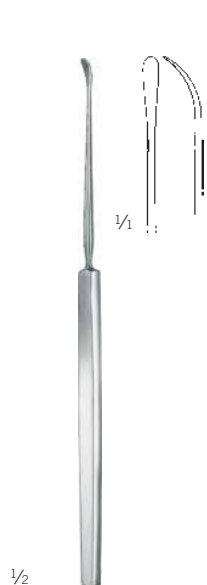

Zaufal
 22-786-16
 15 cm / 5 7/8"
 Fremdkörperhebel
 Foreign Body Lever
 Elevador para cuerpos extraños
 Anse auriculaire
 Leva per corpi estranei



Hartmann
 22-786-16
 16 cm / 6 2/8"
 Ohrhäkchen
 Ear Hooklet
 Ganchito auricular
 Levier pour corps étrangers
 Uncino auricolare



Lucae
 22-793-01
 22-793-03
 14 cm / 5 4/8"

Fig. 1
 22-793-01

Fig. 2
 22-793-02

Fig. 3
 22-793-03



Ear Hooklet, Tympanum Needles

Ohrhäkchen, Trommelfellnadeln
 Ganchito auricular, Agujas para tímpano
 Levier pour corps étrangers, Instruments pour corps étrangers
 Uncino auricolare, Strumenti per corpi estranei

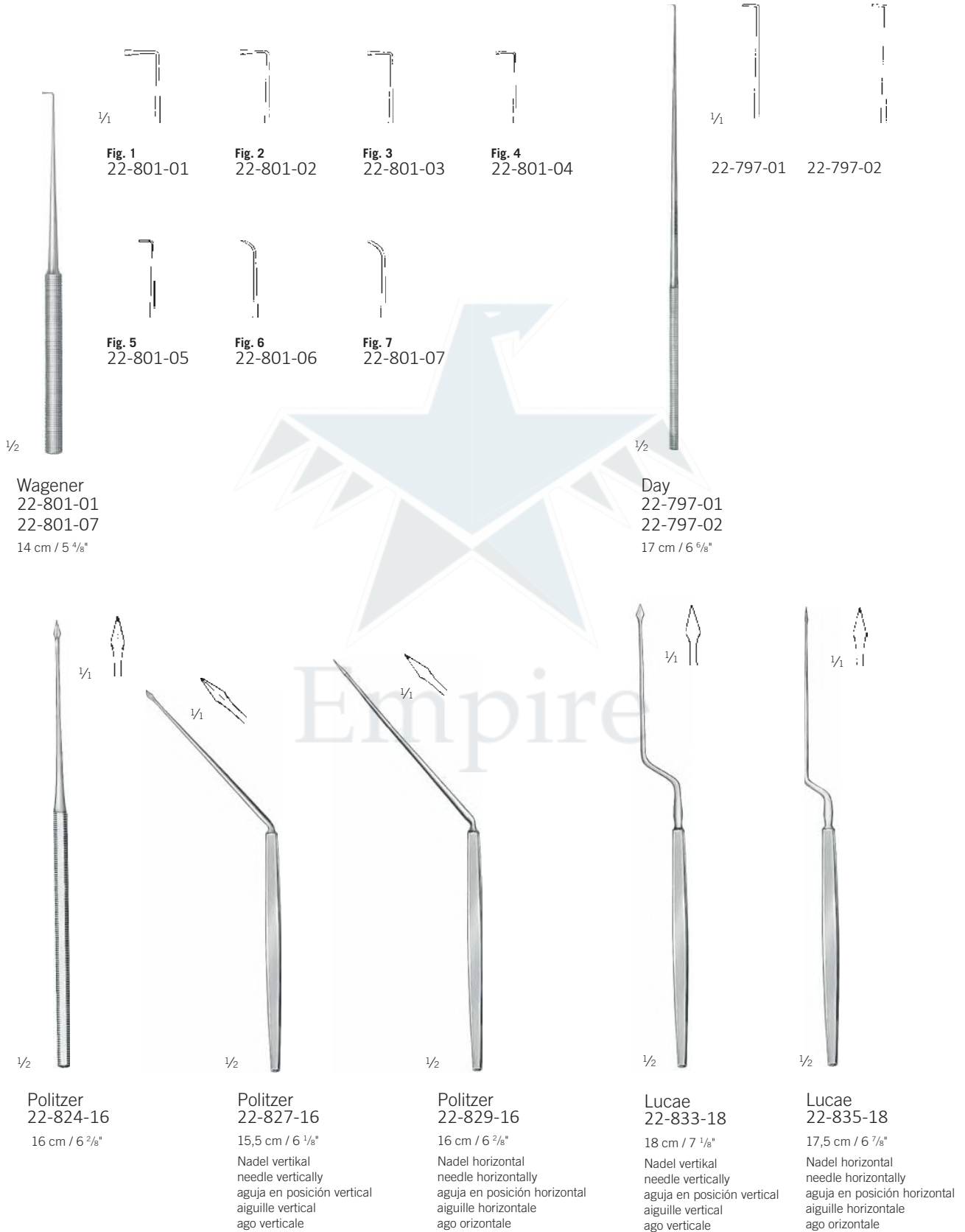

Ear Periosteal Elevators, Ear Scoop

Ohrraspatorien, Ohrloffel

Legras auriculares, Cucharilla auricular

Rugines-raspatoires auriculaires, Ruggine-raspatoire auriculaire

Raspatori auricolari, Curetta auricolare

Otology

Otologie

Otologia

Otologie

Otologia

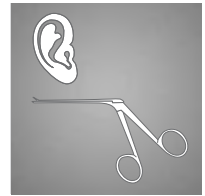

Lempert
22-887-20
20,5 cm / 8 1/8"

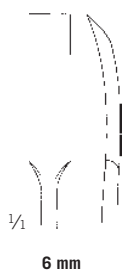

Lempert
22-889-17
18 cm / 7 1/8"



Lempert
36-743-10 -
36-743-50
21,5 cm / 8 5/8"
scharf
sharp
agudo
pointu
acuto

1/2 
Fig. 5
36-743-50



Fig. 4
36-743-40

Fig. 3
36-743-30

Fig. 2
36-743-20

Fig. 1
36-743-10



Atomizers

Pulverbläser
Pulverizadores
Lance-poudre
Insoffiatore



36-780-11

11 cm / 4"

Ohrkanüle
Ear Cannula
Cánula auricular
Canule auriculaire
Cannula auricolare

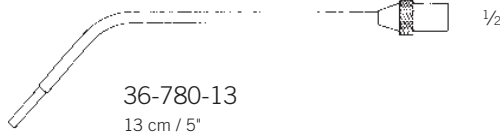

36-780-13

13 cm / 5"

Ohrkanüle, gebogen
Ear Cannula, curved
Cánula auricular, curva
Canule auriculaire, courbe
Cannula auricolare, courbe

36-780-90

Dichtungsring
Washer
Lavadora
Lessiveuse
Guarnizione ad anello

36-780-91

Mittelteil mit Ball
Middle part with ball
Parte central con bola
Partie moyenne avec balle
Parte centrale con palla



36-780-08

8 cm / 3"

Ohrkanüle
Ear Cannula
Cánula auricular
Canule auriculaire
Cannula auricolare

36-780-01

Ersatzflasche
Spare Bottle
Frasco suelto
Flacon de rechange
Bottiglia di ricambio
30 ccm

36-780-50

Ventilball
Valve Rubber Bulb
Pera de goma con valva
Poire en caoutchouc avec valve
Pallone in gomma con valva

Kabierske
36-780-00

komplett mit 3 Kanülen und Gummiball
complete with 3 cannulas and rubber bulb
completo con 3 cánulas y pera de goma
complet avec 3 canules et poire en caoutchouc
completo con 3 cannule e pera di gomma

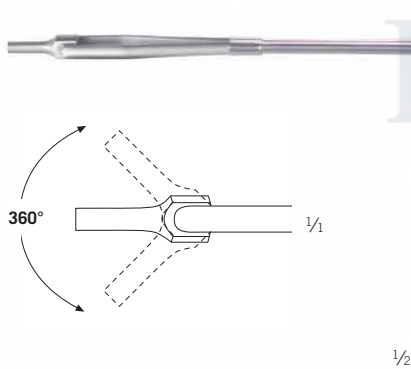

Universal
36-786-00

komplett mit beweglicher Düse, Schraubflasche
30 ccm und Halbgebläse
complete with movable tube, screw bottle 30 ccm
and rubber bulb
completo con tubo móvil botella con rosca 30 ccm
y pera de goma
complet avec tuyère mobile, flacon fileté 30 ccm
et poire en caoutchouc
completo con tubo mobile, bottiglia con filettatura
30 ccm e pera di gomma

Universal
36-786-01

wie Art.-Nr. 36-786-00
jedoch ohne Gebläse
as ref. 36-786-00
but without rubber bulb
como ref. 36-786-00
pero sin pera de goma
comme réf. 36-786-00
mais sans poire en caoutchouc
come rif. 36-370-00
però senza pera di gomma

37-851-05

Gebläse, allein
rubber bulb, only
pera de goma, suelto
poire en caoutchouc, seul
pera di gomma, solo



Air Bags

Luftduschen
Insufladores de aire
Insufflateur d'air
Insoffiatore d'aria

Otology

Otologie
Otologia
Otologie
Otologia

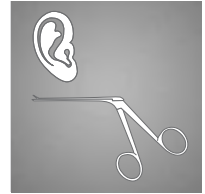

1/2

36-792-03

Einsteckkonus
Connecting Nozzle
Cono de conexión
Embout conique de raccordement
Cono di connessione



1/2

36-792-04

Ohrolive
Ear Olive
Oliva auricular
Olive auriculaire
Oliva auricolare
Ø 4 mm



1/2

36-792-15

Nasenolive
Nose Olive
Oliva nasal
Olive nasale
Oliva nasale
Ø 15 mm



1/2

36-792-17

Nasenolive
Nose Olive
Oliva nasal
Olive nasale
Oliva nasale
Ø 17 mm



1/2

36-792-22

Nasenolive
Nose Olive
Oliva nasal
Olive nasale
Oliva nasale
Ø 22 mm



1/2

Politzer
36-792-00

komplett mit 3 Nasenoliven
Art.-Nr. 36-792-15- bis 36-792-22
complete with 3 nasal olives
ref. 36-792-15 to 36-792-22
completo con 3 olivas nasales
ref. 36-792-15 a 36-792-22
complet avec 3 olives nasales
réf. 36-792-15 jusqu'à 36-792-22
completo con 3 olive nasali
rif. 36-792-15 fino a 36-792-22



36-792-50

Gummibirne
Rubber Bulb
Pera de goma
Poire en caoutchouc
Pera in gomma

Politzer
36-792-01

wie Art.-Nr. 36-792-00
mit zusätzlicher Ohrolive Art.-Nr. 36-792-04
as ref. 36-792-00
with additional ear olive ref. 36-792-04
como ref. 36-792-00
con oliva auricular adicional ref. 36-792-04
comme réf. 36-792-00
avec olive auriculaire supplémentaire réf. 36-792-04
come rif. 36-792-00
con oliva auricolare supplementare rif. 36-792-04



1/2

Politzer
36-792-02

wie Art.-Nr. 36-792-01
in Kunststoffbox
as ref. 36-792-01
in plastic box
como ref. 36-792-01
en caja plástica
comme réf. 36-792-01
en boîte en matière plastique
come rif. 36-792-01
in contenitore di plastica





Ear Syringes

Ohrspritzen
 Jeringas auriculares
 Seringues auriculaires
 Siringhe auricolari



1/2

36-794-00

komplett, selbstfüllend
 in Kunststofftasche
 complete, self filling
 in plastic pouch
 completo, auto-rellena
 en bolsa plástica
 comple, à remplissage automatique
 en pochette en matière plastique
 completo, auto-riempente
 in borsa di plastica



36-794-03

Verbindungsschlauch
 Flexible Tube
 Tubo de conexión
 Tube de connection
 Tubo di connessione

1/2



1/2



1/2



1/2

36-794-90

Gummidichtung
 Rubber gasket
 Junta de goma
 Joint de caoutchouc
 Guarnizione di gomma

36-794-02

Ventilaufsatz
 Valve Attachment
 Válvula de conexión
 Soupape
 Valvola di connessione

36-794-04

Saugansatz
 Suction Nozzle
 Pieza de succión
 Embout à aspiration
 Aspiratore

36-794-05

Schutzsteller
 Protecting Disc
 Disco protector
 Plaque de protection
 Disco protettivo

36-794-91

Rückhaltefeder
 Retention spring
 Muelle de retención
 Ressort de rétention
 Molla di ritenzione



1/2



1/2



1/2



1/2

36-795-01

Spritze, allein, 10 ml
 Syringe, only, 10 ml
 Jeringa, suelto, 10 ml
 Seringue, seul, 10 ml
 Siringa, solo, 10 ml

36-794-06

Metallolive
 Metal Olive
 Oliva metálica
 Olive en métal
 Oliva in metallo

36-794-07

Konischer Ansatz
 Conical Tip
 Punta cónica
 Pointe conique
 Punta conica

36-794-08

Geknöpfter Ansatz
 Button ended Tip
 Punta de botón
 Pointe boutonnée
 Punta a bottone

36-794-09

Gewindeansatz
 Threaded Tip
 Punta de rosca
 Pointe filetée
 Punta filettata



Ear Syringes

Ohrspritzen
Jeringas auriculares
Seringues auriculaires
Siringhe auricolari

Otology

Otologie
Otologia
Otologie
Otologia

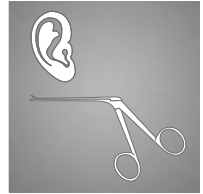

36-795-91

Spülansatz
Irrigation adapter
Adaptador de irrigación
Adaptateur à irrigation
Adattatore per lavaggio



36-795-92

Spülansatz
Irrigation adapter
Adaptador de irrigación
Adaptateur à irrigation
Adattatore per lavaggio



36-795-00

50 ml

komplett mit Teller und 2 Ansätzen
complete with protection disc and 2 tips
completo con disco protector y 2 puntas
complet avec plaque de protection et 2 pointes
completo con disco protettivo e 2 punte

36-795-90

Ohrspritze
Ear Syringe
Jeringa auricular
Seringue auriculaire
Siringa auricolare

36-795-04

100 ml

komplett mit Teller und 2 Ansätzen
complete with protection disc and 2 tips
completo con disco protector y 2 puntas
complet avec plaque de protection et 2 pointes
completo con disco protettivo e 2 punte





Nasal Specula

Nasenspekula
Espéculos nasales
Spéculums nasaux
Specoli nasali



1/2

Goldsmith (Thudichum)
23-101-01
23-101-03
6,5 cm / 2 1/8"

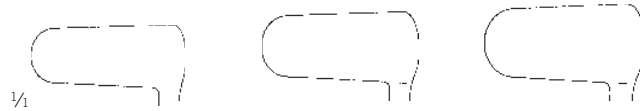

Fig. 1
23-101-01

Blätter
blades
hojas
lames
lame
18,5 x 9,5 mm

Fig. 2
23-101-02

Blätter
blades
hojas
lames
lame
21,0 x 10,5 mm

Fig. 3
23-101-03

Blätter
blades
hojas
lames
lame
21,0 x 11,5 mm



1/2

Hartmann-Halle
23-109-01
23-109-03
16 cm / 6 3/8"

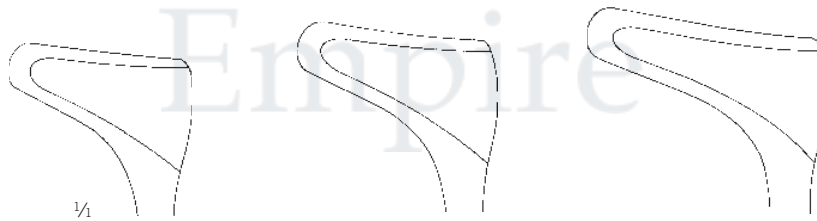

Fig. 1
23-109-01

Blätter
blades
hojas
lames
lame
27 mm

Fig. 2
23-109-02

Blätter
blades
hojas
lames
lame
31 mm

Fig. 3
23-109-03

Blätter
blades
hojas
lames
lame
35 mm



Nasal Specula

Nasenspekula
Espéculos nasales
Spéculums nasaux
Specoli nasali

Otology

Otologie
Otología
Otologie
Otologia

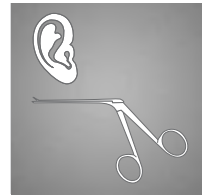

1/1
Blätter
blades
hojas
lames
lame
17 mm

Martin
36-848-13
13 cm / 5 1/8"



1/1
Blätter
blades
hojas
lames
lame
17 mm

Martin
36-849-13
13 cm / 5 1/8"



1/1
Blätter
blades
hojas
lames
lame
16 mm

Tieck-Halle
36-852-13
13 cm / 5 1/8"



Killian
23-120-01
23-120-04

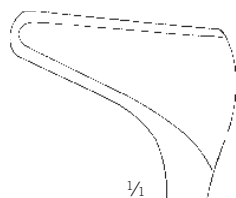

Fig. 1
23-120-01
14 cm / 5 4/8"
Blätter
blades
hojas
lames
lame
35 mm

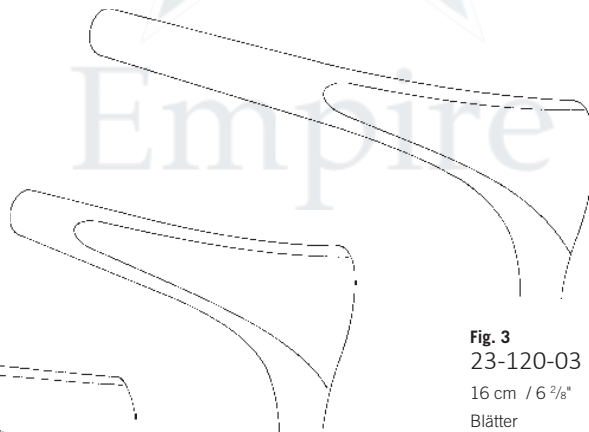

Fig. 2
23-120-02
14,5 cm / 5 6/8"
Blätter
blades
hojas
lames
lame
50 mm

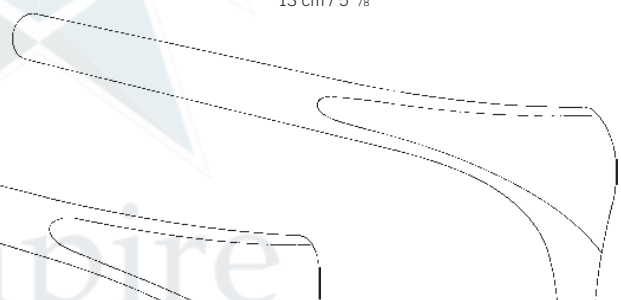

Fig. 3
23-120-03
16 cm / 6 2/8"
Blätter
blades
hojas
lames
lame
75 mm



Fig. 4
23-120-04
17 cm / 6 6/8"
Blätter
blades
hojas
lames
lame
85 mm



Nasal Specula

Nasenspekula
 Espéculos nasales
 Spéculums nasaux
 Specoli nasali



Mod. Wien
 23-122-14
 13,5 cm / 5 3/8"

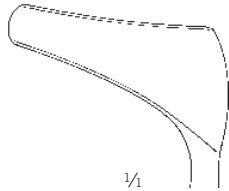

1/1

Blätter
 blades
 hojas
 lames
 lame
30 mm



Cottle
 23-127-01
 23-127-04

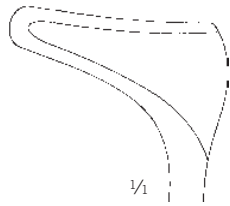

1/1

Fig. 1
 23-127-01
 13,5 cm / 5 3/8"
 Blätter
 blades
 hojas
 lames
 lame
35 mm

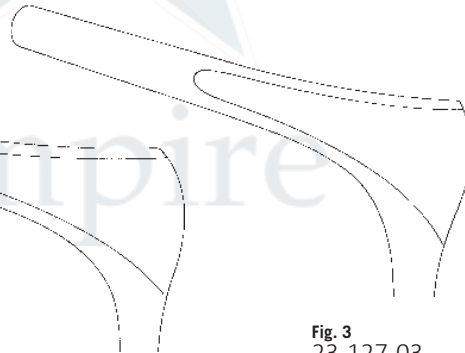

Fig. 2
 23-127-02
 14 cm / 5 4/8"
 Blätter
 blades
 hojas
 lames
 lame
50 mm

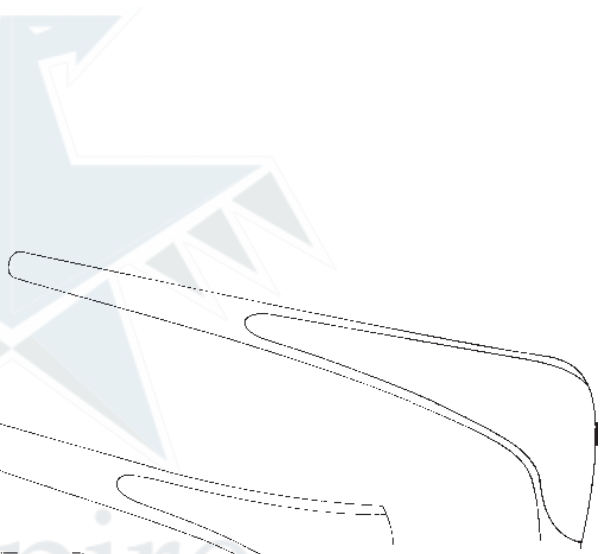

Fig. 3
 23-127-03
 16 cm / 6 2/8"
 Blätter
 blades
 hojas
 lames
 lame
75 mm

Fig. 4
 23-127-04
 16 cm / 6 2/8"
 Blätter
 blades
 hojas
 lames
 lame
85 mm

Nasal Specula

Nasenspekula
Espéculos nasales
Spéculums nasaux
Specoli nasali

Otology

Otologie
Otologia
Otologie
Otologia

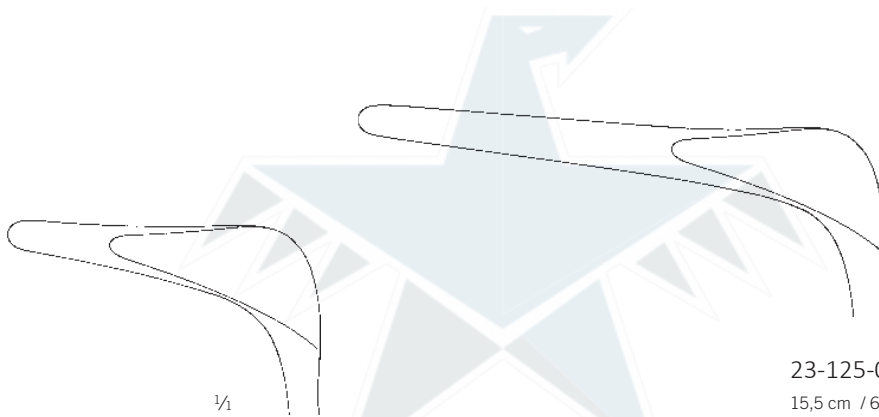
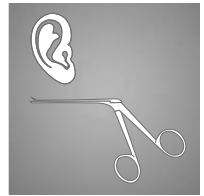

1/4

23-125-01

14 cm / 5 1/8"

Blätter
blades
hojas
lames
lame
45 mm

23-125-02

15,5 cm / 6 1/8"

Blätter
blades
hojas
lames
lame
75 mm



1/2

Cottle

23-125-01

23-125-02

schwarz
black
negro
noir
nero





Polypus Snares

Polypenschnürer
 Polipótomos
 Serre-noeuds pour polypes
 Serranodi per polipi

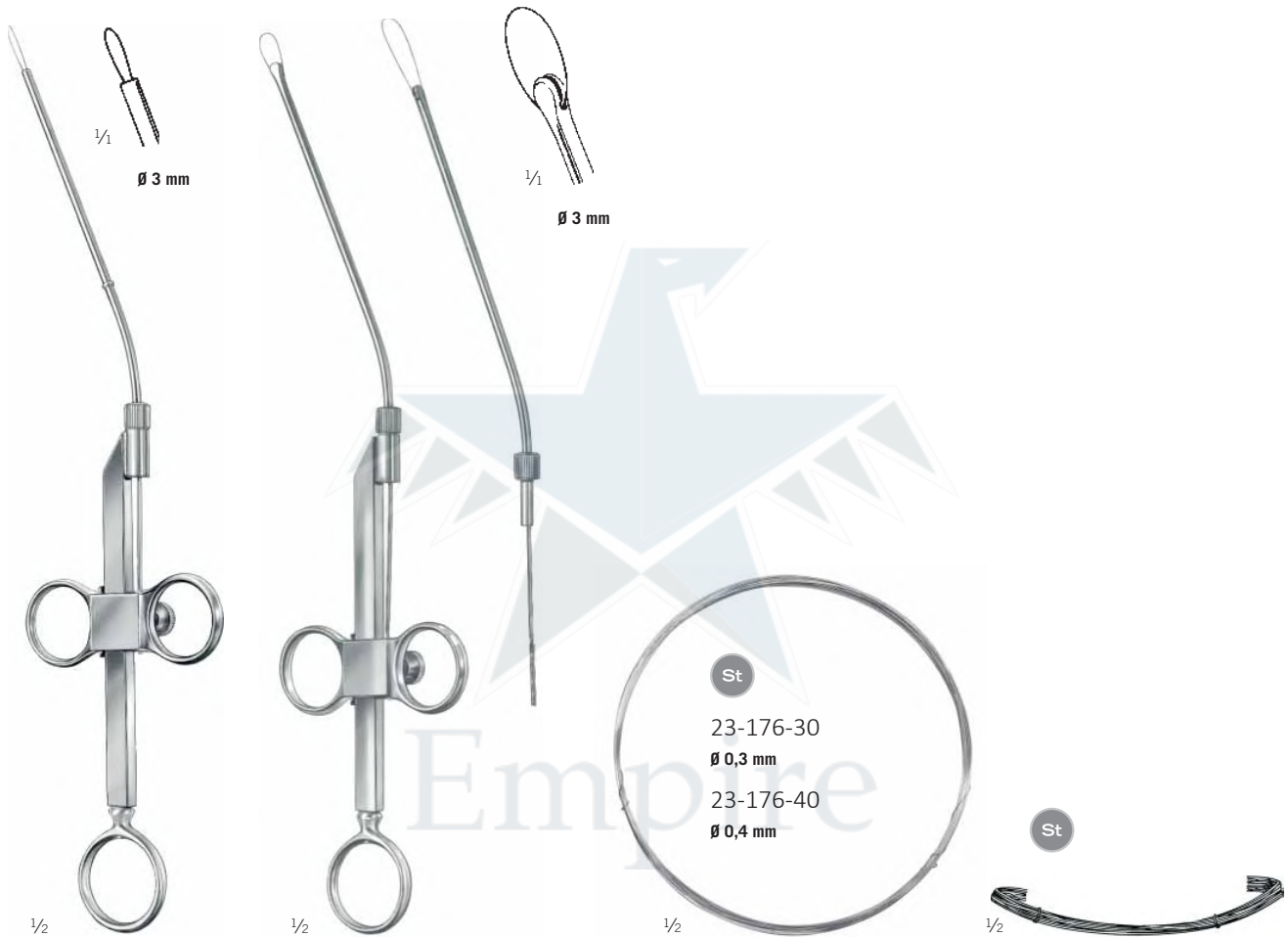

Krause
 23-161-26
 26 cm / 10 2/8"
 Schaft
 shaft
 vástago
 tige
 asta

Krause-Voss
 23-165-26
 26 cm / 10 2/8"
 Schaft
 shaft
 vástago
 tige
 asta

23-176-30
 23-176-40
 Schnürdraht
 Snare Wire
 Asa de alambre
 Anse en fil d'acier
 Filo per allacciare
 Rolle mit 10 m
 coil of 10 m
 rollo de 10 m
 en rouleaux de 10 m
 rotolo di 10 m

23-177-12
 10,5 cm / 4"
 Schnürdraht
 Snare Wire
 Asas de alambre
 Anses en fil d'acier
 Filo per allacciare
0,3 mm Ø
 Bündel mit 12 Stück
 bundle with 12 pieces
 12 piezas atados
 paquet de 12 pièces
 confezione di 12 pezzi