

ROCK

Hydraulic retractable bollard
height 700 mm



For collective and
industrial usage



Available in 230V



ROCK

Hydraulic pump integrated in the top section, to assist with maintenance activities

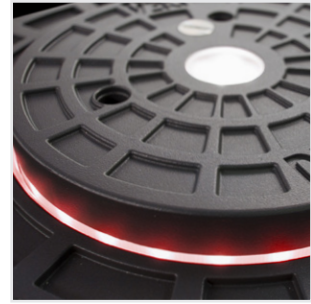

High visibility thanks to the reflective band and the diffuser with red LED

Removable structure with double anti-corrosion treatment: cataphoresis and thermal painting black polyester



The DE@NET universal control board makes this operator compatible with NETLINK System.



Compatible with NETCOM, the device for installation maintenance and remote control management!

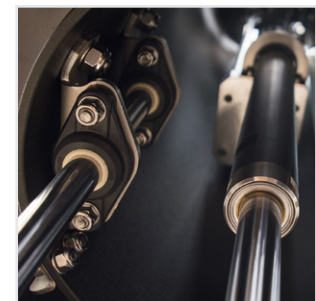

Linear guide system with chrome-plated steel cylinders

Suitable for intensive usage thanks to the hydraulic circuit power.

The version with cable simplifies the wiring phase and ensures watertight integrity





Models

230V ~ bollard without control board



COD.	Art.					OTHER CHARACTERISTICS
651000	ROCK		275mm	700mm	6mm	<ul style="list-style-type: none"> Removable structure, cataphoresis treatment Emergency manual release LED diffusers with integrated buzzers 2 magnetic limit switches Walking surfaces in aluminium, cataphoresis, micaceous grey Retro-reflecting film with high-luminous efficacy 15m cable (only for art. ROCK/CABLE) Framework with cataphoresis treatment to be cemented (art. ROCK/B) not included Colour: NERO SIDERALE PERL Electrovalve for quick descent in case of power failure (only item ROCK/CABLE/EL)
651001	ROCK/ CABLE		275mm	700mm	6mm	
651002	ROCK/ CABLE/EL		275 mm	700 mm	6 mm	

All models: framework art.ROCK/B not included

Fixed bollard

COD.	Art.					OTHER CHARACTERISTICS
651020	ROCK/F		274 mm	700 mm	4 mm	<ul style="list-style-type: none"> Fixed bollard with cataphoresis treatment Retro-reflecting film with high-luminous efficacy

All models: Foundation base art.ROCK/FB not included

Example of a typical installation

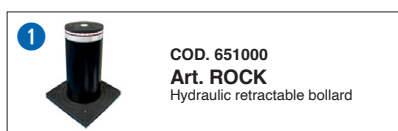
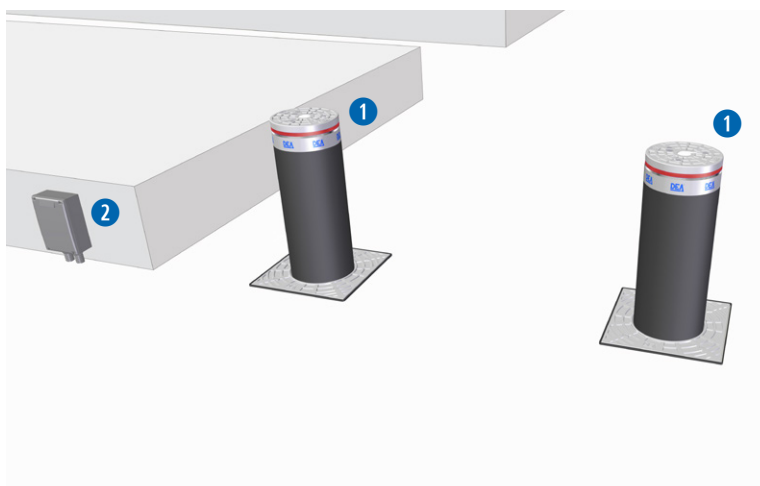

+

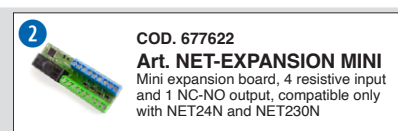

SPECIFIC ACCESSORIES

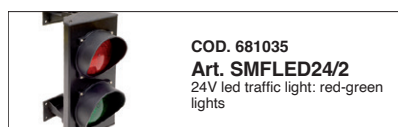
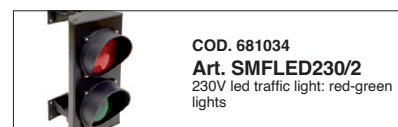
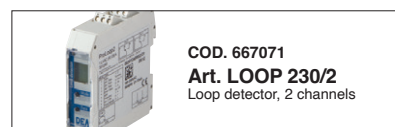
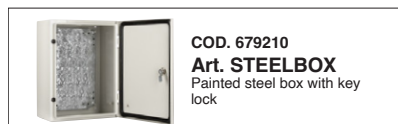
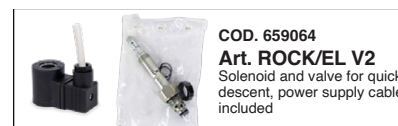
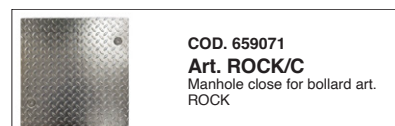
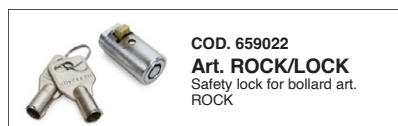
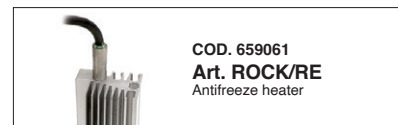
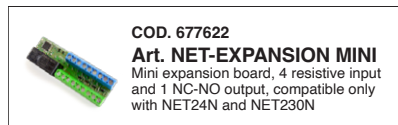
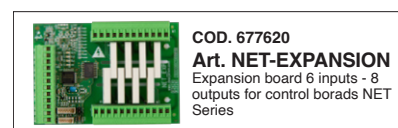
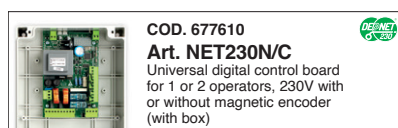

Technical info

TECHNICAL INFO	ROCK	ROCK/CABLE	ROCK/CABLE/EL
Movement		Hydraulic	
Height		700mm	
Diameter		Ø274mm (±2mm)	
Material		Steel Fe 360	
Treatment		Cataphoresis and polyester powder paint, black	
Ascent time		6 sec	
Descent time		5 sec	
Quick descent time (with solenoid valve and power failure)		1,5 sec	
Usage		Intensive	
N. max cycles in 24h.	2000 (T= 20 ÷ 22°C) - 1000 (+ art. ROCK/EL)		1000
Reflective band		50mm	
Emergency manual manoeuvre		Mechanical unlocking on hydraulic circuit	
Impact resistance		29KJ with clamps ; 40KJ with armor reinforcement	
Crash resistance		29KJ with clamps ; 138KJ with armor reinforcement	
Cable for connection	/	15 m FG16 7x1,5 + 10x0,5	
Operating temperature		-15°C + 50°C -25°C + 50°C with heater	
Obstacle detection		Adjustable pressure switch	
Product weight		130 kg	
Hydraulic pump		Power supply 230V+-10% 50/60 Hz	
Power absorption	400 W		420 W
Protection level		IP67	
Capacitor		12,5 µF	
Motor thermal protection		130°C	



ELECTRICAL DIAGRAM

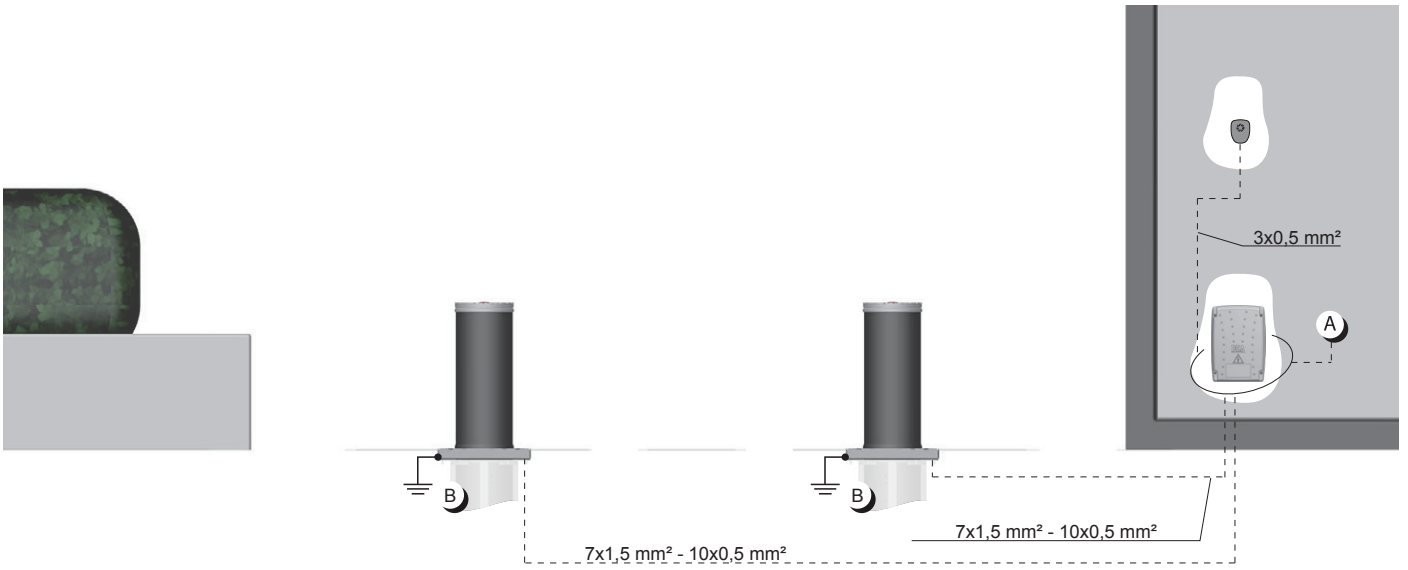

COD.	Art.
677610	NET230N/C
677611	NET230N/PROBOX
677620	NET-EXPANSION
677622	NET-EXPANSION MINI



art.
NET230N/C



art.
NET-EXPANSION



art.
NET-EXPANSION MINI



art.
NET230N/C



art.
NET-EXPANSION



art.
NET-EXPANSION MINI



Dimensions

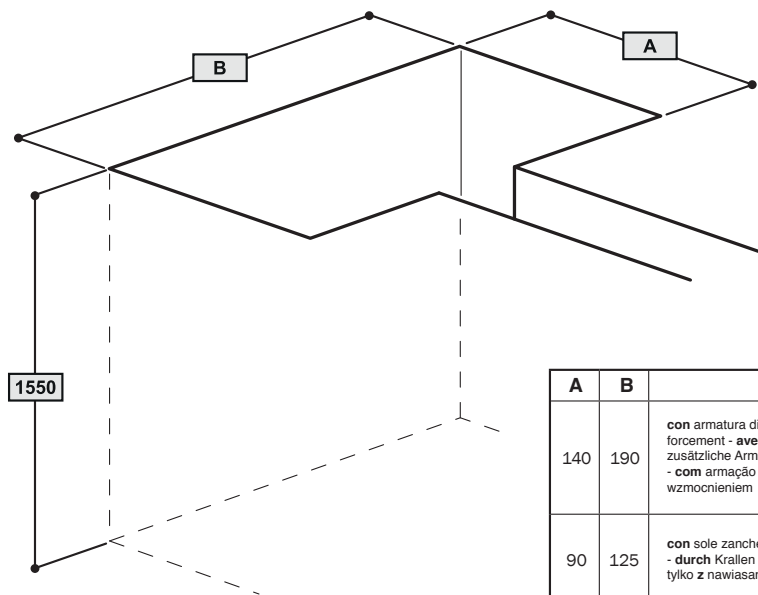
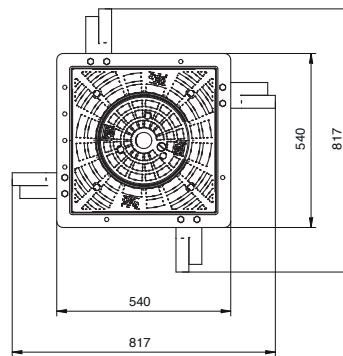
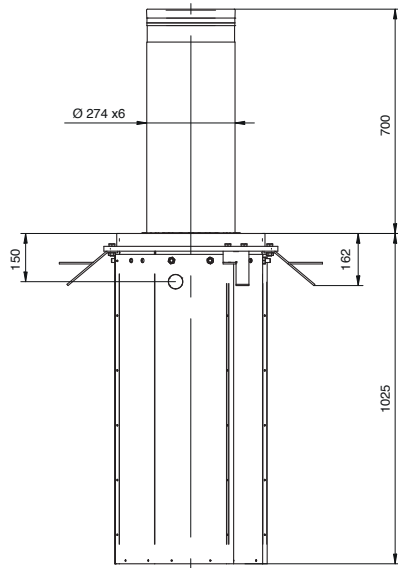

A	B	
140	190	con armatura di rinforzo - with additional reinforcement - avec l'armature additionnelle - durch zusätzliche Armierungseisen - con soporte adicional - com armação adicional - z dodatkowym wzmocnieniem
90	125	con sole zanche - with anchor bolts - avec le barres - durch Krallen - con grapas - com braçadeiras - tylko z nawiasami kłamirowymi



DEAuser



DEAuser is the app for **private users** that allows activation of automation at **close proximity** via Bluetooth.

By installing the NET-NODE on all devices with NETLINK technology, users can control their automations through their smart devices.

To be used with:



Art. NET-NODE 2.0
Cod. 677642



DEAinstaller



DEAinstaller is the App dedicated to the **professional installer** and allows Installers to program and manage DEA automations on-site in a simple and intuitive way from their smart devices.

If you use it with the NET-NODE you can:

- ✓ keep a **data backup** of all installations
- ✓ easily adjust the **parameters** of control boards
- ✓ update the **firmware**
- ✓ program the **maintenance**
- ✓ manage or customise the **remotes**
- ✓ read **technical manuals** or have a look at the **electrical connections**
- ✓ control the **inputs** and **output** of the control boards
- ✓ **control** the automation with the App

To be used with:



Art. NET-NODE 2.0
Cod. 677642

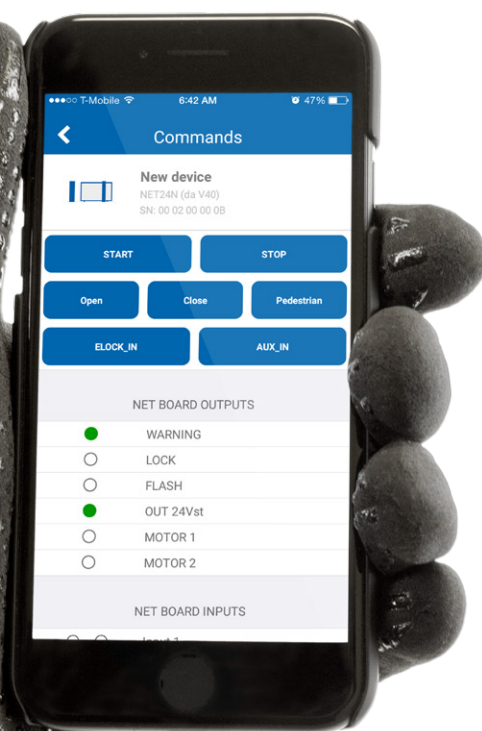



LINEAR XS
cod. 662080



LINEAR
cod. 662044



COVER/2
cod.681060



LINEAR SHIELD
cod. 662047



PILLY 60 -120
cod. 664000 - 664010



DIGIPRO
cod. 663310



DIGISLIM
cod. 663311

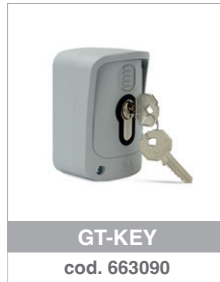

GT-KEY
cod. 663090



DIGIRAD
cod. 663280



LOOP230/1 - /2
cod. 667061 - 667071



GTI2-GT14
cod. 672635 - 672645



GTI2M-GT14M
cod. 672603 - 672613



SMFLED-230/2 - 24/2
cod. 681034 - 681035

#safeasyoulike!

Non-copyable remotes!

GTI remotes are multi-function. They have three coding possibilities: DIP SWITCH, Rolling Code and D.A.R.T. the new DEA advanced coding.

You can customise the code of the remotes to guarantee the maximum security to your customer.

- D.** DEA
- A.** Advanced
- R.** Rolling Code
- T.** Transmission

Looking for **total safety**?
With **NET-BOX** each installer can customise the code of your GTI remotes.



#colourasyoulike!

Choose your favorite colour!

GTI remotes can be customised with button kits in seven colours: green, light green, blue, pink, yellow, orange and purple.



Note: button kits are supplied in packs of 5. The remote must be ordered separately.



NETLINK

is our technology applied to DEA devices for the smart management of your installations, both **locally** and **remotely**.



Our range

Automations for sliding gates



LIVI N



REV



GULLIVER



Automations for sectional doors

NEW

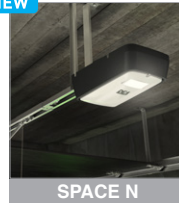

SPACE N



NEW



ADVANCE N



LIVI 902



Automations for swing gates

NEW



MAC



NEW



STING



NEW

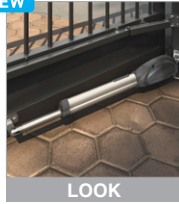

LOOK



GEKO



LIVI 502

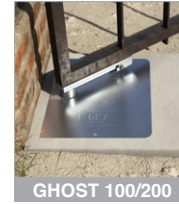

GHOST 100/200



OLI N



Automations for industrial gates



LATO



550 PL



Barriers

NEW



PASS N



NEW



STOP N



TRAFIK



Bollards

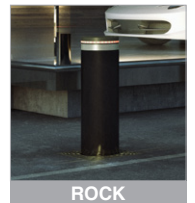

ROCK



DEA
move as you like

HEADQUARTER
DEA SYSTEM S.p.A.
Via della Tecnica, 6 - 36013 Piovene Rocchette (VI) - ITALY
☎ + 39.0445.55.07.89 - 📠 + 39.0445.55.02.65
info@deasystem.com - www.deasystem.com

Branches > Italia, France, United Kingdom, Ireland, España,
Portugal, Polska, Deutschland, Беларусь

> **HEAD OFFICE**
DEA System UK & IRE
Sandholes Road - Cookstown - Co. Tyrone
BT80 9AR - IRELAND
☎ + 44 (0)28 8676 6476 - 📠 + 44 (0)28 8676 2414
info@deasystem.net

DEA System UK & IRE
Unit 31 - The IO Centre - Hearle Way - Hatfield - Hertfordshire
AL10 9EW - UNITED KINGDOM
☎ + 44 (0)1707 246 599
contact@deasystem.net