

BILT HARD®

**Dethatcher and Scarifier 13 Inch 12 Amp
Owner`s manual& safety instructions**



Using tips:
Video on Youtube











Introduction

Reading and storing the user manual

These operating instructions form an integral part of this 2 in 1 Electric rake / scarifier (hereafter referred to only as the scarifier). It contains important instructions on safety, use and maintenance. Please familiarise yourself with all operating and safety instructions before using the scarifier. Only use the scarifier as described and for the stated purpose. If the scarifier is passed on to a third party, please provide all documents to the third party together with the scarifier. Keep the operating instructions safe for the future reference.

Explanation of symbols

The following symbols and signal words are used in this user manual, on the scarifier or on the packaging.

 WARNING!	Indicates a hazardous situation that, if not avoided, could result in death or serious injury.
 CAUTION!	Indicates a hazardous situation that, if not avoided, could result in minor or moderate injury.
 NOTICE!	Warns of possible damage to property.
	This symbol provides you with useful additional information regarding assembly or operation.
	Read the user manual.
	Wear ear protection.
	Wear safety goggles.
	WARNING - Beware sharp blades, keep fingers and toes away. Blades will continue to rotate for a short time after the motor is switched off.







LIMITED 90 DAYS WARRANTY BILT HARD makes every effort to assure that its products meet high quality and durability standards, and warrants to the original purchaser that this product is free from defects in materials and workmanship for the period of 90 days from the date of purchase. This warranty does not apply to damage due directly or indirectly, to misuse, abuse, negligence or accidents, repairs or alterations outside our facilities, criminal activity, improper installation, normal wear and tear, or to lack of maintenance. We shall in no event be liable for death, injuries to persons or property, or for incidental, contingent, special or consequential damages arising from the use of our product. Some states do not allow the exclusion or limitation of incidental or consequential damages, so the above limitation of exclusion may not apply to you. This warranty is expressly in lieu of all other warranties, express or implied, including the warranties of merchantability and fitness. To take advantage of this warranty, the product or part must be returned to us. Proof of purchase date and an explanation of the complaint must accompany the merchandise. If our inspection verifies the defect, we will either repair or replace the product at our election or we may elect to refund the purchase price if we cannot readily and quickly provide you with a replacement. We will return repaired products at our expense, but if we determine there is no defect, or that the defect resulted from causes not within the scope of our warranty, then you must bear the cost of returning the product. This warranty gives you specific legal rights and you may also have other rights which vary from state to state.

Troubleshooting

Problem	Possible cause	Rectification
The motor does not start	Power supply is faulty	Check the mains connection
	Mains cable is faulty	Check the mains cable
	On / off switch is faulty	Contact customer service
	Scarifier housing is blocked	Clean the scarifier housing
Motor performance is decreasing	Soil is too hard	Reduce the working depth
	Roller is worn out	Replace the roller
	Scarifier housing is blocked	Clean the scarifier housing and reduce the working depth
Motor stops	Extension cable is loose	Check the extension cable connection
Bad scarifying result	Roller is worn out	Replace the roller
	Incorrect scarifying	Setting the working depth
	Grass too high	Mow the lawn

Technical specifications

Model	TIA-1001				
Rated voltage	120V~60HZ				
Rated power	12A				
Working width	13 inch				
Working depth	Position	1	2	3	4
	Scarifying	-0.47"	-0.31"	-0.16"	0.16"
	Raking	-0.6"	-0.4"	-0.2"	0.16"

	Remove plug from the mains before maintenance, adjusting, cleaning or if the cord is entangled or damaged.
	Risk of electric shock.
	Keep the mains cable away from the blades of the rotating roller.
 	Keep bystanders away!
	Protection category II: The scarifier is double insulated.

Safety

Scope of use

This scarifier is exclusively designed for private use and for the following hobby and DIY applications:

- Scarifying lawns
- Aerating lawns

It must be used in accordance with the instructions and safety warnings contained in this manual and may not be used for any other purpose. It is designed for DIY use only and is not suitable for commercial or heavy duty use, such use may damage your appliance and invalidate your warranty. Neither the manufacturer nor the retailer can accept any responsibility for injury, loss or damage caused by misuse of any kind. Examples of misuse are given in the following nonexhaustive list:

- Any use beyond the specified intended use.
- Failure to follow the safety, installation, operating, cleaning and maintenance instructions given in this user manual.
- Failure to comply with applicable health, safety and accident prevention regulations regarding the use of this scarifier.
- Using accessories and spare parts which are not suitable for this scarifier.

- Modifying the scarifier.
- Commercial or otherwise excessive use

Anyone who operates or services the scarifier must be familiar with these instructions and must be aware of possible dangers. This scarifier may only be used by a competent person – in case of doubt seek training or advice from an expert.

Non-observance of the safety, assembly and operating instructions while operating the scarifier counts as misuse. Any applicable health and safety regulations must be followed. Any other applicable local and national legislation must also be followed.

The scarifier may not be modified as modifications may cause damage or injury.

Residual risks

Residual risks cannot be completely ruled out even in case of proper use. Due to the nature of the scarifier, the following dangers may arise:

- Ejected or flying debris can cause injury if the correct preventative measures are not followed.
- Damage to hearing if effective hearing protection is not worn.

General safety instructions



WARNING!

Read all safety warnings and all instructions. *Failure to follow the warnings and instructions may result in electric shock, fire and/or serious injury.*

Save all warnings and instructions for future reference.

The term "power tool" in the warnings refers to your mains-operated (corded) power tool or battery-operated (cordless) power tool.

Training personal safety and preparation

- Read the all operating and safety instructions carefully.** *Be familiar with the controls and the scope of use of the scarifier.*
- The scarifier is not intended for use by persons (including children) with reduced physical, sensory or mental capabilities, or lack of experience and knowledge.** *Never allow children or people unfamiliar with these instructions to use the scarifier. Local regulations can restrict the age of the operator. Children should be supervised to ensure that they do not play with the scarifier. Local regulations may restrict the age of the operator.*

Only use spare parts / accessories from the manufacturer or authorised and qualified workshops.

Clean the scarifier housing thoroughly after each use to prevent blockages.

Repairs should only be carried out by qualified technicians or by an authorised service centre. Qualified technicians must have relevant training and experience, be familiar with the design and construction requirements of the scarifier and understand the safety regulations.

Cleaning



CAUTION!

NEVER immerse the scarifier in water.

Clean the scarifier using a dry cloth. Never use strong and / or abrasive cleaning agents or solvents. Allow all the parts to dry completely. Ensure that water does not get into the scarifier.

Clean the scarifier housing, safety flap and collection bag immediately after finishing the work.

Clean the vents on the motor housing and remove any remaining grass or dirt.

Storage

We recommend using the original packaging for storage or covering the product with a suitable cloth or enclosure to protect it against dust. Always store the product in a place that is inaccessible to children. The ideal storage temperature is between 10 °C and 30 °C.

- Switch the product off.
- Clean the product as described above.
- Store the product and its accessories in a dark, dry, frost-free, well-ventilated place.

Transport

Use the original packaging and secure the scarifier against shock and vibrations during transport.

Always carry the scarifier using the handle provided for this purpose.

Work instructions

Scarifying

- Scarify only dry lawns.
- Set the scarifying depth correctly. The blades should cut the grass by only a few millimeters. For maximum scarifying depth, put the lever in position 1 and in position 3 for the minimum scarifying depth.
- Mow the lawn to a height of two centimetres before scarifying (minimum setting of the lawn mower).
- Run the scarifier quickly over the area and do not stay in one place for too long, otherwise the grass will be badly damaged.
- Move the device first lengthwise and then transversely over the surface, creating a checkered pattern.
- When changing directions, press the handle down so that the blades are in the air.
- Sow fresh grass seeds in bare spots immediately after scarifying.
- Rake the loosened thatch thoroughly from the lawn surface.
- After scarifying, spread roughly 2cm soil, sand or lawn quartz to improve the aeration of the lawn.

Raking lawns

Lawns can be raked all year round and is advisable. When raking the lawn, small holes are made, these provide drainage in the soil and thus prevent water logging. The material dug out is collected in the collection bag. Raking the lawn prevents soil compaction, improves the oxygen supply and thus promotes the growth of the grass. Rake the mowed lawn once every 3 to 4 weeks during the growth phase.

Maintenance, cleaning and storage

WARNING!

Disconnect the scarifier from the mains before performing any type of maintenance or adjustments.

Maintenance

Check the rollers regularly for wear and damage. Damaged or worn rollers invite poor performance. Replace the roller with a new one when necessary. Only use original replacement parts.

- c. Never work while people, especially children, or pets are nearby.** *Keep in mind that the operator or user is responsible for accidents or hazards occurring to other people or their property.*
- d. Dress properly.** *Do not wear loose clothing or jewelry. Keep your hair, clothing, and gloves away from moving parts. Loose clothes, jewelry or long hair can be caught in moving parts.*
- e. Always wear substantial footwear and long trousers.** *Do not operate the scarifier when barefoot or wearing open sandals.*
- f. Be aware that hard or stony soil can be hazardous.** *Thoroughly inspect the area where the scarifier is to be used and remove all objects which can be thrown up by the machine.*
- g. Before using the scarifier, always visually inspect to see that the tines are not worn out or damaged.** *Replace worn out or damaged tines and bolts in sets to preserve balance.*

Electrical Safety

- h. The scarifier's plug must match the outlet.** *Never modify the plug in any way. Unmodified plugs and matching outlets will reduce risk of electric shock.*
- i. Do not expose the scarifier to rain or wet conditions.** *Water entering the scarifier will increase the risk of electric shock.*
- j. Do not abuse the cord, if the supply cord is damaged, it must be replaced by the manufacturer, its service agent or similarly qualified persons in order to avoid a hazard.** *Never use the cord for carrying, pulling or unplugging the scarifier. Keep cord away from heat, oil, sharp edges or moving parts. Damaged or entangled cords increase the risk of electric shock.*
- k. It is recommended to only connect the scarifier to a supply circuit protected by a residual current device (RCD) with a tripping current of not more than 30mA.**
- l. Use an extension cord suitable for outdoor use.** *Use of a cord suitable for outdoor use reduces the risk of electric shock.*

Operation

- m. Work only in daylight and in good weather conditions.** *Never work in rainy, wet or stormy conditions.*
- n. Avoid accidental starting.** *Ensure the switch is in the off-position before plugging in. Carrying the scarifier with your finger on the switch or plugging in the scarifier with the switch on invites accidents.*

- o. Do not operate the scarifier in explosive atmospheres, such as in the presence of flammable liquids, gases, or dust.** *The scarifier can create sparks which may ignite the dust or fumes.*
- p. Ensure that you maintain a firm grip of the handle when operating the scarifier.** *Walk, never run with the scarifier and exercise extreme caution when reversing or pulling the scarifier towards you.*
- q. Do not overreach.** *Keep proper footing and balance at all times. This enables better control of the scarifier in unexpected situations.*
- r. Working on slopes is hazardous.** *Do not work on excessively steep slopes. Always be sure of your footing on slopes. Exercise extreme caution when changing direction on slopes.*
- s. Start the scarifier carefully according to manufacturer's instructions and with feet well away from the tines.** *Do not put your hands or feet near or under rotating parts.*
- t. Never pick up or carry the scarifier while it is running.** *Stop the scarifier whenever you leave the machine and before performing any kind of cleaning or maintenance.*
- u. Do not force the scarifier.** *Use the correct tool for your application. The correct tool will do the job better and safer at the rate for which it was designed.*
- v. Do not use the scarifier if the switch does not turn it on and off.** *Any power tool that cannot be controlled with the switch is dangerous and must be repaired.*
- w. Stay alert, watch what you are doing and use common sense when operating the scarifier.** *Do not use a power tool while you are tired or under the influence of drugs, alcohol, or medication. A moment of inattention while operating power tools may result in serious personal injury.*

Service, Maintenance and storage

- x. Disconnect the plug from the power source before making any adjustments, changing accessories, or storing the scarifier.** *Such preventive safety measures reduce the risk of the scarifier starting accidentally.*
- y. Maintain your scarifier.** *Check for misalignment or binding of moving parts, breakage of parts, and any other condition that may affect the scarifier's operation. Keep all nuts, bolts and screws tight to ensure the scarifier is in safe working condition. Replace worn or damaged parts for safety;*

- Make a loop, run it through the eye of the mains cable cleat **13** and secure it using the clip.



Switching ON/OFF

- Tilt the scarifier slightly backwards if necessary to enable a safe start.

Switching on:

- Press the safety switch **1** and pull the ON / OFF lever **2**.
- Lower the scarifier back to the ground.
- Hold the scarifier with both hands on the upper handle bar **3** and on the ON / OFF lever while working.

Switching off:

- Release the ON / OFF lever.

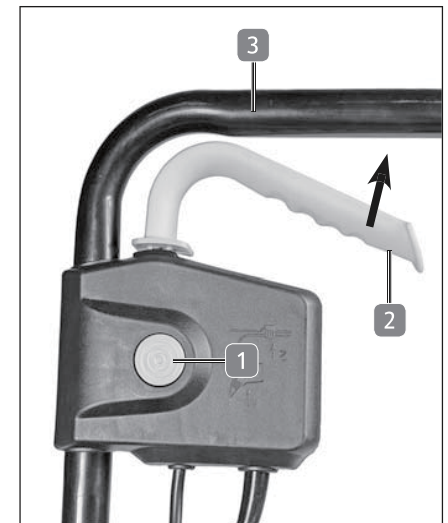

Setting the working depth

NOTICE!

Set the working depth lever **9** to position 4 before transporting the device. Position 4 is meant for transport. Do not use the scarifier with the working depth lever in position 4.

- Pull the working depth lever up and engage it in one of the positions 1–3.

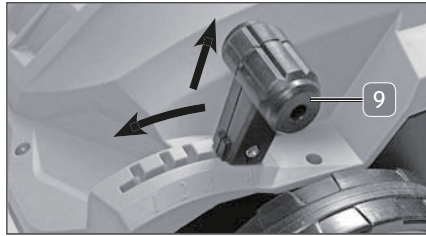

Working depth

Position	1	2	3	4
Scarifying	-0.47"	-0.31"	-0.16"	0.16"
Rake	-0.6"	-0.4"	-0.2"	0.16"

Usage

Mains connection

The scarifier is designed for use with single-phase AC 120V~60HZ and has protective insulation. Check whether the existing mains voltage matches with the specification on the rating plate of the scarifier.

If the work area is not close to the mains outlet, use an extension cable with sufficient conductor diameter (min. 1,5 mm²). The extension cable used should be as short as possible.

Use the mains cable cleat to avoid damage to the power cable and the extension cable.

- z. **If damaged, have the scarifier repaired before use.** *Accidents can occur if the scarifier is poorly maintained.*
 - aa. **Have your power tool serviced by a qualified repair person using only identical replacement parts.** *This will ensure that the safety of the power tool is maintained.*
 - ab. **Store the scarifier out of the reach of children and do not allow persons unfamiliar with the scarifier or these instructions to operate the power tool.** *The scarifier can be dangerous in the hands of untrained users.*

Before using the scarifier

Checking the scarifier and pack contents

WARNING!

If any parts are damaged or missing, do not operate the scarifier until the parts are replaced. Failure to heed this warning could result in serious personal injury.

- Take the scarifier and the components out of the packaging.
- Check that the delivery is complete (see section: "List of contents and features")
- Check whether the scarifier or any of its individual parts are damaged.
- If this is the case, do not use the scarifier. Contact the manufacturer at the service address specified on the warranty card.

List of contents and features

- | | |
|---------------------------------|----------------------------|
| 1. Safety switch | 10. Carrying handle |
| 2. ON / OFF lever | 11. Lower handle bars (2x) |
| 3. Upper handle bar | 12. Cable clips (2x) |
| 4. Fixing wrenches & Bolts (4x) | 13. Mains cable cleat |
| 5. Middle handle bars (2x) | |
| 6. Collection bag | |
| 7. Safety flap | |
| 8. Wheels | |
| 9. Depth adjustment lever | |



- | |
|---------------------------------|
| 14. Scarifying roller (mounted) |
| 15. Allen key |
| 16. Lawn rake roller |

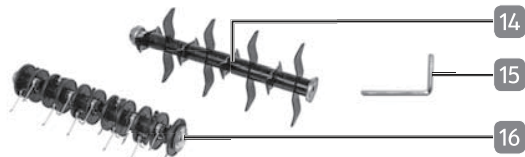

Before using the scarifier

- Lift the roller **G** so that the suspension is free.

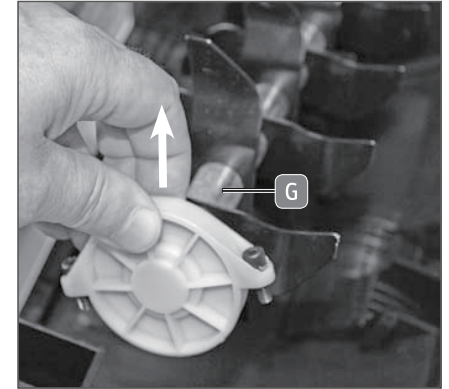

- Remove the roller **H** from the drive spindle **I**.

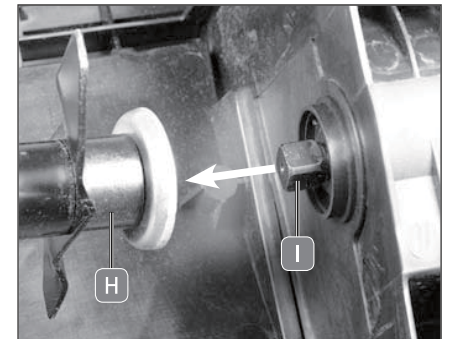

- Remove the roller suspension from the ball bearings **J** of the roller.
- Insert the roller suspension onto the ball bearing of the required roller.
- Assemble the roller in the reverse order.

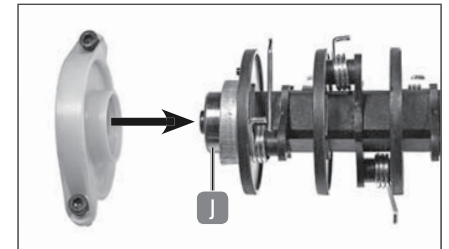

- Lift the safety flap **7** and mount the collection bag **6** using the two hooks into the corresponding notches on the scarifier housing. Ensure that the safety flap is seated flush; this fixes the collection bag in place.



Replacing the roller

WARNING!

Disconnect the scarifier from the mains before performing any type of maintenance or adjustments.

Use only original accessories or accessories authorised by the manufacturer.

i Tools required:
Allen key 4 mm (included in the supply)

- Turn the scarifier over.
- Loosen the two Allen screws **E** holding the roller suspension in place **F**.

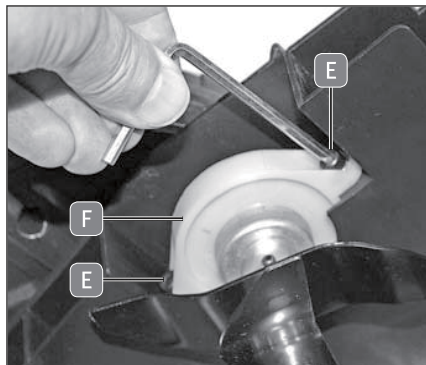

Assembly

i Tools required: Phillips-head screwdriver (not included in the supply)

WARNING!

Disconnect the scarifier from the mains before performing any type of maintenance or adjustments.

Assembling the handle

- Loosen the two Phillips-head screws **A** on the scarifier housing.

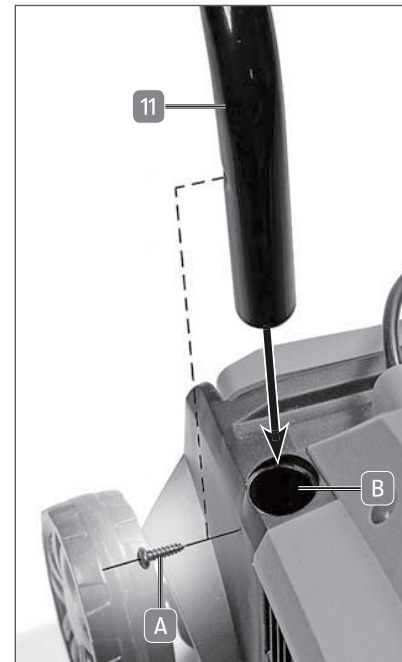
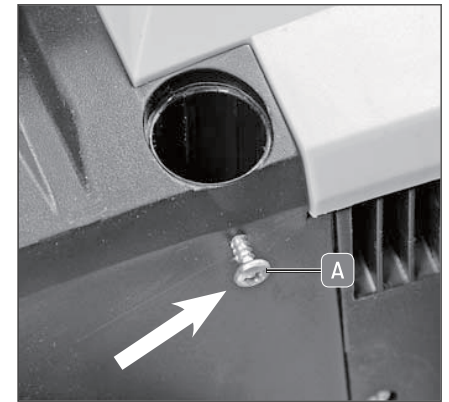

- Slide the two lower handle bars **11** into the corresponding openings **B** in the scarifier housing.
- Fix the lower handle bars using the Phillips-head screws.

Before using the scarifier

- Fit the two middle handle parts (1 b) to the lower parts of the handle with the help of the bolts (4b) and knurled nuts (4a).

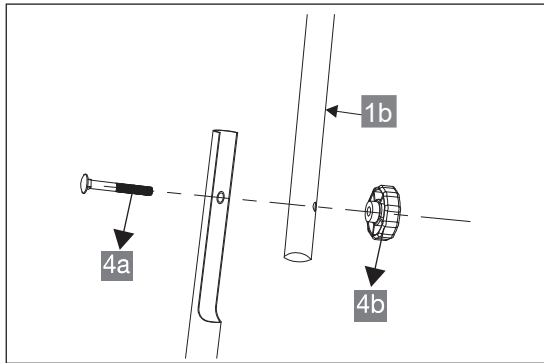

- Guide the cord strain relief (3) over the top part of the handle (1a) on the switch side and fasten this to the middle handle parts with the bolts and knurled nuts

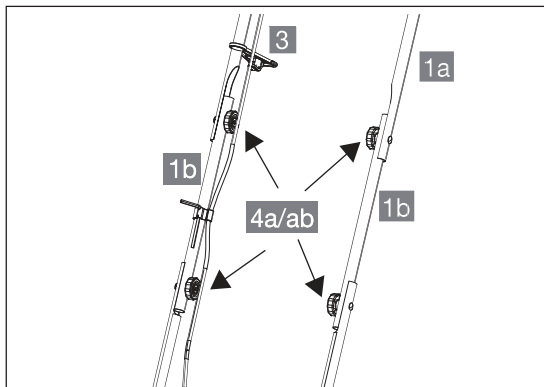

Before using the scarifier

Assembling the safety switch

- Loosen the Phillips-head screws (C) on the underside of the safety switch (1) and remove the plate (D).
- Insert the safety switch from above and the plate from below onto the upper handle bar (3) and fix the unit using the two Phillips-head screws.

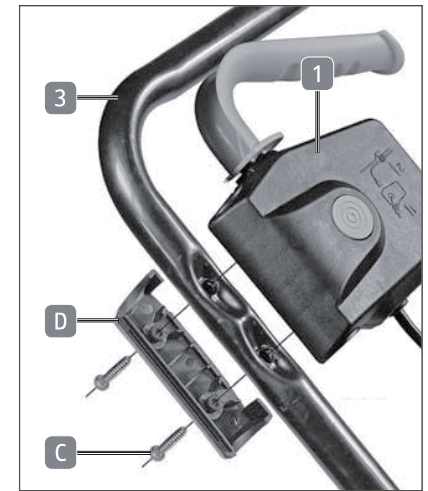

- Position the mains cable along the handle bars and secure it using the two cable clips (12).



Assembling the collection bag

CAUTION!

Never operate the scarifier without or with a faulty safety flap



The collection bag is intended only for use with this scarifier.