

Art SPM4FLGU...

**ca** creative  
cables

4xMAX 4W GU10 MR11

110-240 V

Cl. II  IP20 

SE IL CAVO FLESSIBILE ESTERNO DI QUESTO APPARECCHIO VIENE DANNEGGIATO DEVE ESSERE SOSTITUITO DAL COSTRUTTORE O DAL SUO SERVIZIO ASSISTENZA O DA PERSONALE QUALIFICATO EQUIVALENTE AL FINE DI EVITARE PERICOLI

IF THE EXTERNAL FLEXIBLE CABLE OF THIS LUMINAIRE IS DAMAGED, IT SHALL BE EXCLUSIVELY REPLACED BY THE MANUFACTURER OR HIS SERVICE AGENT OR A SIMILAR QUALIFIED PERSON IN ORDER TO AVOID HAZARDS

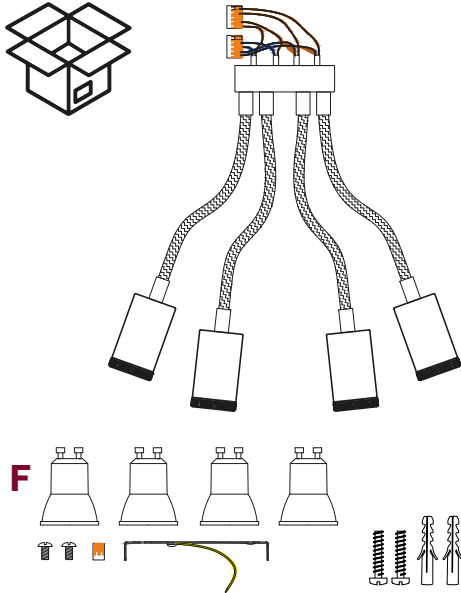

**1**

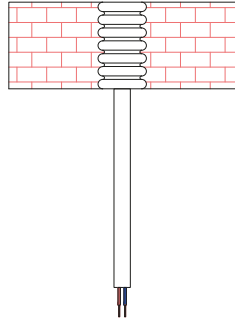
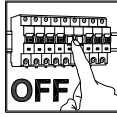

**2**

min 70  
max 80 mm

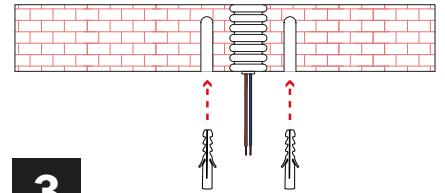
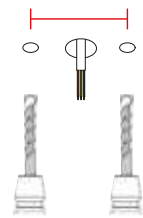

**3**

**4**

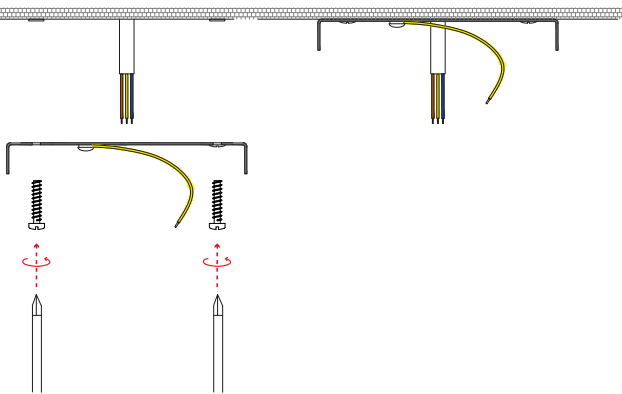

**5**

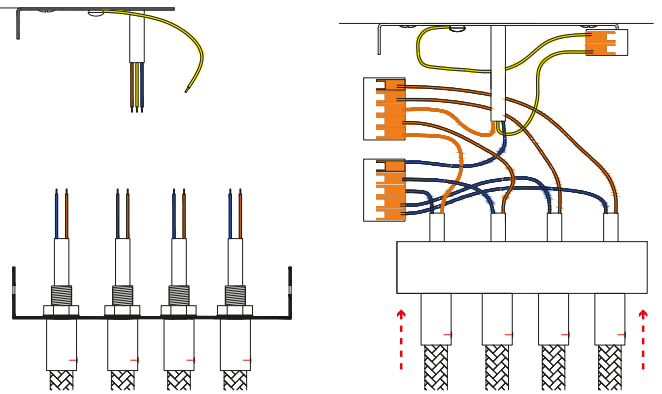

**6**

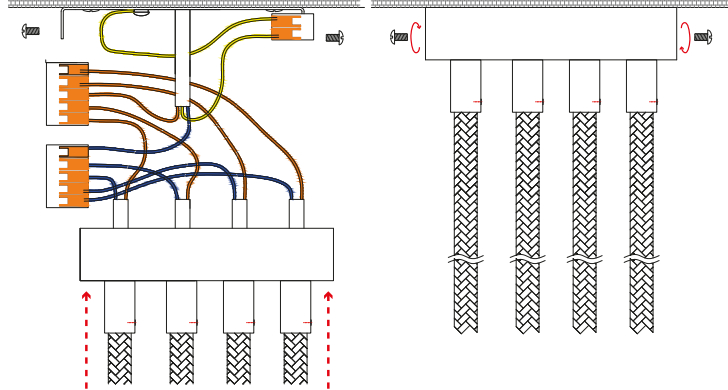

**7**

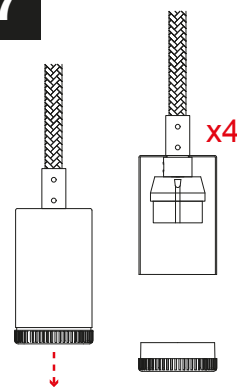

**8**

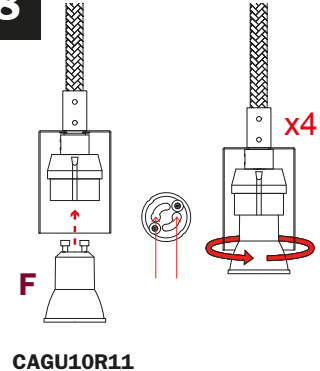

**9**

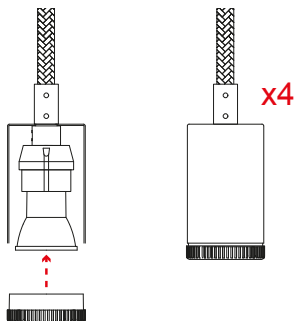

**10**

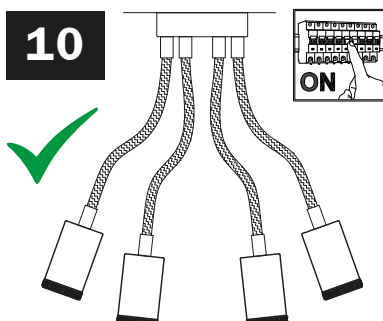

**n°4 CAGU10R11**

**MR11 GU10  
LED BULBS  
Ø max 35mm**

