

Assembly Instructions

Item No.: 128-05-11-01-01

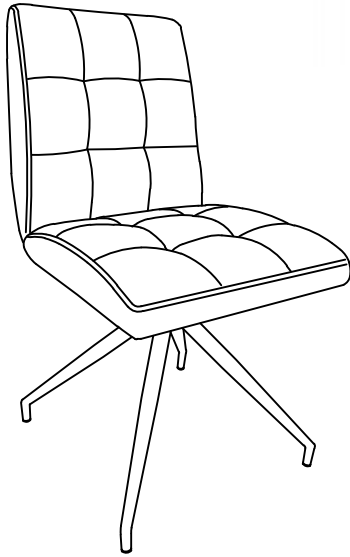

+ Parts Included

①

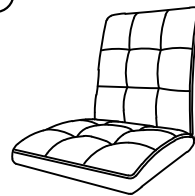

(1pc)

②

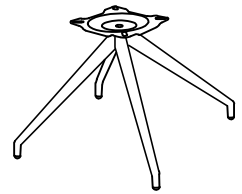

(1pc)

+ Do Not Use Power Tools



+ Suggested Adults



NOTE: For questions about parts or assembly please email support@shankar.uk.com

1. Read instructions cover to cover.
2. Save all packaging until assembly is completed.

+ Hardware Included

A

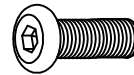

screw
(4pcs)

B

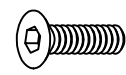

screw
(2pcs)

C



Flat washer
(4pcs)

D



Allen Key
(1pc)

E

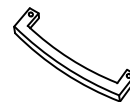

handle
(1pc)

F

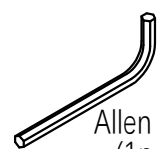

Allen Key
(1pc)

IMPORTANT ASSEMBLY INFORMATION

Assembly Step:

- 1) Use Screws to connect Part to Part.
- 2) Please strictly follow the assembly steps to assemble

Do not tighten until all hardware is locked

Assembly Instructions

Item No.:128-05-11-01-01

①

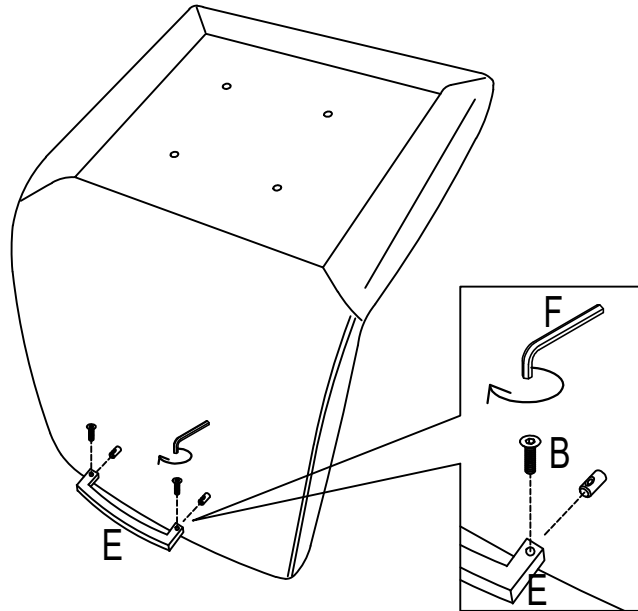

②

