

ROVER

Owner's Manual



<https://www.kingbullbike.com/>

About Manual

This manual contains details of the product, information on its operation and maintenance, and other helpful tips for owners. Please read it carefully and familiarize yourself with the Kingbull Bike before use to ensure safe operation, reduce the risk of damage and premature wear, and prevent accidents. Retain this manual as your convenient source of information for your Kingbull Bike.

The manual includes numerous warnings and cautions regarding safe operation, along with consequences if proper setup, operation, and maintenance guidelines are not followed. All information in this manual should be thoroughly reviewed.

Users should pay special attention to information marked with an “*” in this manual.

As it is impossible to anticipate every situation or condition that may occur while riding, this manual does not make representations about the safe use of our bicycles under all conditions. There are inherent risks associated with the use of any bicycle that cannot be predicted or avoided, and these are the sole responsibility of the rider. Keep this manual, along with any other documents included with your bicycle, for future reference. However, please note that all content in this manual is subject to change or withdrawal without notice. Visit www.kingbullbike.com to download the latest version. The assembly and initial adjustment of your Kingbull Bike require special tools and skills; it is recommended that this be performed by a trained bicycle mechanic if possible.

***The recommended minimum rider age is 16 and older, and the maximum rider age is 70 and under. Any rider who cannot sit comfortably on an e-bike should not attempt to ride it.**

Table of contents

Specification	4
Assembly Guide.....	6
·Preparation Checklist.....	6
·Assembly Instructions.....	7
·Safety Check.....	13
·Safety Precautions.....	14
Display.....	15
Use and Care.....	21
·Battery Charging.....	21
·Riding Modes	27
·Riding Limitations.....	28
·Parking & Transport.....	28
·Safety and Care Instructions	29
Maintenance	30
·Battery Maintenance.....	30
·Motor Maintenance	30
·Chain Maintenance	30
·Front Fork Maintenance	31
Warranty.....	31

Specification



Battery	Lithium Battery 48V 17.5Ah	Charger	US Standard 3.0A Smart Charger
Range	60-80 Miles	Controller	48V/25A
Motor	750W Brushless Gear Motor	Display	Color LCD Display with USB Charging
Pedal Assist Intelligent	0-5 Level Pedal Assist	Tires	26" x 4" CST Fat Tires
Throttle	Half Twist Throttle	Brake lever	Hydraulic Brake
Front Fork	Dual Crown Shock-Absorbing Hydraulic Front Fork	Taillight	None
Pedal	All Aluminum Pedal	Freewheel	Shimano 7-Speed Gear Shift System
Bike Frame	All Aluminum Frame	Brake	Power-Off Hydraulic Brake + 180MM Brake Disc
Headlight	48V LED Light	Chain	D50 Chain, 124Link
Saddle	All Black Leather Comfort Saddle	Seat post	30.4 x 350MM Aluminum Alloy Seat Post
Crank set	170mm Forged Aluminum	Kickstand	Aluminum Alloy Kickstand
Gearing	Shimano-14-28T BROWN/BK	Spokes	Spoke Wheel

Assembly Guide

◆ Preparation Checklist



Pedals



Headlight



Hex wrench

*NOTICE:

1. Please keep the original packaging for at least 30 days!
2. Before assembling your bike, it's recommended to remove the battery for the reasons outlined below:
 - Determine if there's battery drain or damage during shipping.
 - Reduce the weight of the e-bike to make it easier to maneuver the bike while assembling.
 - Avoid battery damage during the assembly process.

Assembly Instructions

◆ Handlebar Installation

STEP1: Loosen the bolts on the bike stem and rotate the stem to the front.



STEP2: Loosen the bolts of the double shoulder fork and lift the fork to its highest position, then tighten the fork bolts.



STEP3: Center the handlebars. Tighten bolts to handlebar stem, but don't tighten completely as you may want to further adjust the angle later to align more precisely. After determining the best position, completely tighten all the bolts on the stem.



◆ Front wheel

STEP1: Remove the front wheel hub axle from the front wheel and the front fork protection bar.

STEP2: Pull out the brake protector.



STEP3: Remove the bolts and washers from the front wheel hub shaft. Please remember the installation sequence.



STEP4: Roll the wheel in between the front fork, as shown in the image below. Align the fork dropouts with the axle of the wheel hub. Ensure the washer is in contact with the nut. Verify also that the dropouts are fully seated on the axle and the brake rotor is properly inserted into the caliper.



STEP5: Use a 15mm wrench to tighten the bolts on both sides of the axle, and install the two thumb nuts by pressing them tightly.



◆ Headlight

STEP1: Loosen the bolt on the fork brace. Align the bolt holes of your headlight with the hole on the fork brace, then reinsert the bolt through all holes and tighten the bolt with a wrench and a hex wrench.



STEP2: Connect the light wire connectors together. Pay careful attention to the arrows on the wire connectors, making sure the arrows align with each other to avoid damaging the interior circuitry.



◆ Pedals Installation

Make sure your pedals are installed on the correct side, as installing on the wrong side will damage the threads.

Start threading the pedal on by hand to ensure the pedal is going in perfectly straight, rotating in the direction of the pointer shown on the crank. If it is not spinning smoothly, make doubly sure that you have the correct left or right pedal. After initial hand-tightening, finish tightening the pedals with a standard 15mm wrench .



◆ Saddle

Open the seatpost quick release lever. Adjust the seatpost height by sliding the seatpost up or down to a height appropriate for your leg length and preferred riding position. Do not extend the seatpost beyond the minimum insertion marking etched onto the seatpost.



***Overextending the seatpost can cause it to break or come off your bike, putting you at very high risk of serious injury or death. Avoid this danger by inserting your seatpost into the seat tube far enough that the minimum insertion point is no longer visible.**

◆ Safety Checklist

Safety Check	Basic Steps
Brakes	<p>Test front and rear brakes for proper function.</p> <p>Ensure that the brake pads are not excessively worn and are correctly positioned in relation to the rims.</p> <p>brake control cables are lubricated, correctly adjusted and display no obvious wear.</p> <p>Check that brake control levers are lubricated and tightly secured to handlebars.</p>
Wheels and Tires	<p>Inflate tires to within recommended limits displayed on sidewalls.</p> <p>Check for bulges or signs of excessive wear.</p> <p>Clean tires to ensure tread is exposed.</p> <p>Ensure rims run true and have no obvious wobbles or kinks.</p> <p>Check that all wheel spokes are tight and not broken.</p> <p>Check the wheel balance in Pedal Only Mode.</p> <p>If you notice the riding is imbalanced or the rotation of the front wheel makes noise, it means the bolts were not completely tightened or not aligned horizontally.</p>
Chain	<p>Check that chain is oiled, clean and runs smoothly.</p> <p>Use extra care in wet or dusty conditions.</p>
Crank and Pedals	<p>Securely tighten pedals to cranks.</p> <p>Ensure cranks are securely tightened and are not bent.</p>
Derailleurs	<p>Check that derailleur(s) are adjusted and functioning properly.</p> <p>Ensure shift and brake levers are attached to handlebar securely.</p> <p>Check all brake and shift cables for proper lubrication.</p>
Motor Drive	<p>Ensure hub motor is spinning smoothly and motor bearings are in good working order.</p> <p>Check that all power cables running to hub motor are secured and undamaged.</p> <p>Make sure hub motor axle bolts are secured and all torque arms and torque washers are in place.</p>
Battery Pack	<p>Ensure battery is charged before use.</p> <p>Check for any visible damage to battery pack.</p> <p>Lock battery securely to frame.</p>

◆ Safety Precautions

Your safety is our top priority, and we want to ensure that you have a safe riding experience with your Kingbull bike. Below are some important safety notes that provide additional information on the proper operation and maintenance of your bike. Please review them thoroughly, as incorrect operation or neglecting proper installation and maintenance could lead to serious injury or even death.

*Before Riding

- All users must read and understand this manual before first use. Additional manuals for components used on your bicycle may be provided and should also be read before use.
- Ensure you understand all instructions and safety notes/warnings.
- Follow the safety checklist on page * before first use and at regular intervals to ensure the correct tightening and setup of your bicycle.
- Ensure the bike fits you properly before first use. Check local rules and regulations before riding.
- It is your responsibility to familiarize yourself with the laws and requirements of operation of this product in the area(s) where you ride.

*While Riding

- Always wear an approved bicycle helmet whenever using this product and ensure that all helmet manufacturer instructions are used for the fit and care of your helmet. Failure to wear a helmet when riding may result in serious injury or death.
- Acceleration can be unexpectedly strong in pedal assist mode (Pedal Assist level 1-5), as the motor assist will suddenly engage when you pedal. Therefore, please pay careful attention when riding. We suggest you use Pedal Only Mode (Pedal Assist level 0) when you need to ride at a slow speed to cross roads, at intersections, or when pedestrian traffic is present, to avoid accidents caused by sudden acceleration.
- Follow the safety checklist on page * before first use and at regular intervals to ensure the correct tightening and setup of your bicycle.
- Make sure you securely close the quick-release lever of the front wheel, checking the wheel balance in Pedal Only Mode. If you notice that the riding feels imbalanced, or the rotation of the front wheel makes noise, it likely means the bolts were not completely tightened or didn't align horizontally in the center.
- Off-road riding requires close attention and specific skills, and presents variable conditions and hazards that accompany the conditions.
- Wear appropriate safety gear and do not ride alone in remote areas.

Display

◆ Control Panel

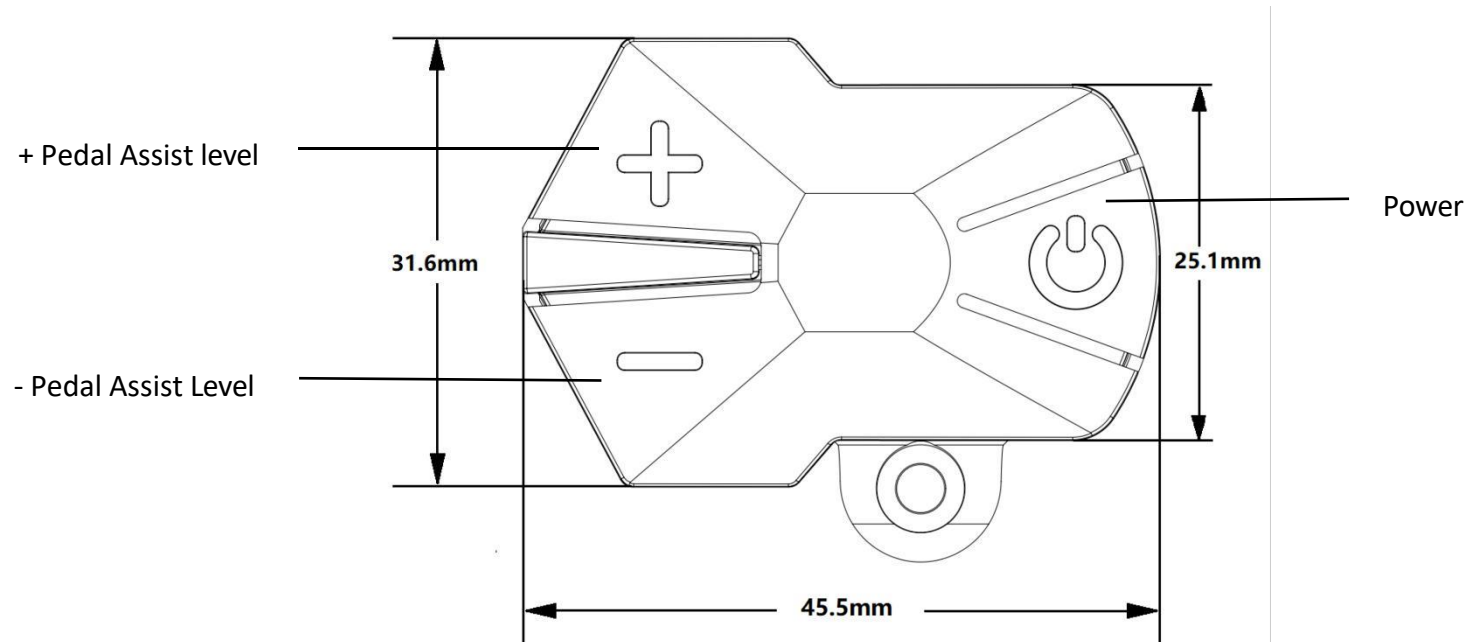

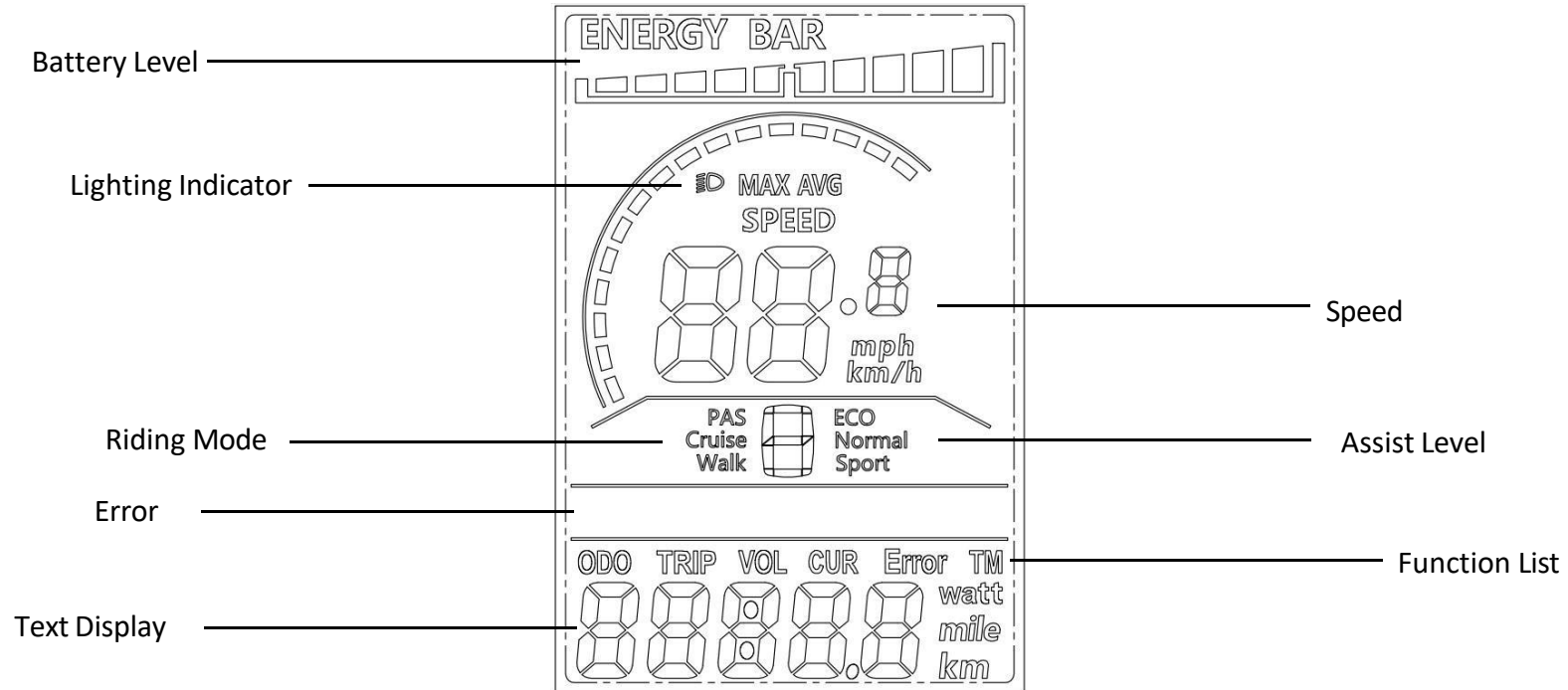

◆ Display Screen





ODO	Total mileage	E33	Current anomaly
TRIP	Single mileage	E34	Turn handle anomaly
VOL	Battery voltage	E35	Motor phase deficiency
CUR	Operating current	E36	Motor Hall anomaly
Error	Error code indication	E37	Brake anomaly
TM	Display startup time	E30	Communication anomaly

◆ Operation Instructions

1. Power ON/OFF

When the power is off, Long press the “” button for 3seconds. The screen will display all contents and start in normal working mode. The controller will turn on when the power is on. To powered off, Long press the “” button for 3 seconds, this will turn off the screen and the controller. If there is no operation on both the bike and the display for 10 minutes (time could be set), the display will automatically turn off. In this case, there will be no power consumption for both the display and the controller.

2. Speed Switch

Long press the “” and “” buttons to switch between different speed information, Real-Time Speed → Max Speed→Average Speed.

3. ODO/TRIP/VOL/CUR/ERROR/TM Switch

Short press the “” button to switch between ODO/TRIP/VOL/CUR/ERROR/TM ODO(Total Mileage)→TRIP(Single Mileage)→VOL(Current Battery Voltage) → CUR (Current Working Current)→ERROR (Error Code)→TM (Display Startup Time).



4. Assist Level

Short press the “”/“” buttons to change the assist level, the default value is level 1.

5. Headlight Control

Long press the “” button for 3 seconds to turn the headlight on/off.

6. 6km/h Mode

When the bike is stopped, long press the “” button and the bike will enter 6km/h mode, the speed will be 4.5~7.5km/h according to different road conditions, “WALK” will show up on screen at the same time. Long press the “” button again to exit this mode.

◆ Parameter Setting

1. When the display is powered on, long press both “+” and “-” simultaneously to enter the parameter setting mode. In this mode, you can change parameter values using “+” or “-”. A short press of “⏻” will allow you to move to the next parameter setting. To exit the settings and save the parameters, Long press “+” and “-” again . If no operation is performed within 8 seconds, the mode will automatically exit, saving any changed parameters.
2. In the parameter setting mode, a short press of “+”/“-” will alter the parameter value, while a short press of “⏻” will save the current value and switch to the next parameter.

◆ Parameter

P01: Backlight Brightness

Short press the “+”/“-” buttons to switch between levels 1 to 3. Level 3 is the brightest, Level 2 is the default value, and Level 1 is the dimmest.

P02: KMH/MPH

Short press the “+”/“-” buttons to switch between KMH and MPH.

0: KM

1: MILE

P03: Working Voltage

Short press the “+”/“-” buttons to switch between 24V, 36V, 48V, and 60V.

P04: Auto Shutdown Time

Short press the “+”/“-” buttons to set the auto shutdown time from 0 to 60 minutes. This is the time (in minutes) until the screen automatically shuts down due to inactivity. A setting of 0 means the screen will never shut down. Other numbers correspond to the shutdown time.

(Range:1~60 minutes)

For example, if you set it to 10, the screen will shut down after 10 minutes.

P05: PAS Mode Setting

Short press the “+”/“−” buttons to adjust PAS mode.

0: 3 PAS modes

1: 5 PAS modes

P06: Wheel Size Selection

Short press the “+”/“−” buttons to switch wheel size:

Number	0	1	2	3	4	5	6	7
Signification	16inch	18inch	20inch	22inch	24inch	26inch	700C	28inch

P07: Number Of Magnets For Speed Sensor

Short press the “+”/“−” buttons to switch from 1 to 15.

P08: Speed Limit

Short press the “+”/“−” buttons to set the speed limit between 10 and 41 km/h.

P09~P15: This Feature is Blank or Invalid**P16: Reset ODO Distance**

Press and hold the “+” button for 5 seconds to reset the odometer distance.

P17: This Feature is Blank or Invalid**P18: Speed Ratio Adjustment**

Short press the “+”/“−” buttons to set the speed ratio from 50% to 150%. The default value is 100%.

P19: Is the 0 PAS displayed

Short press the “+”/“−” buttons to set the value.

0: Contains 0 PAS

1: Excluding 0 PAS

P20~P26: This Feature is Blank or Invalid

Use and Care

The following table of contents provides general guidance on the variable power assist settings of the Kingbull e-bike and their effects on both range and performance. While this content will apply broadly to most riders, individual results may vary due to factors such as rider fitness and weight, terrain, proper maintenance, etc. Kingbull hopes and believes that you will thoroughly enjoy your e-bike, it cannot guarantee universal performance characteristics for all riders.

Battery Charging

◆ Charging Procedure for On-bike Charging

STEP1: Check the battery power indicator on your display.

STEP2: Assemble the charger as shown in Figure 1 by inserting the plug (Plug 1) into the transformer.

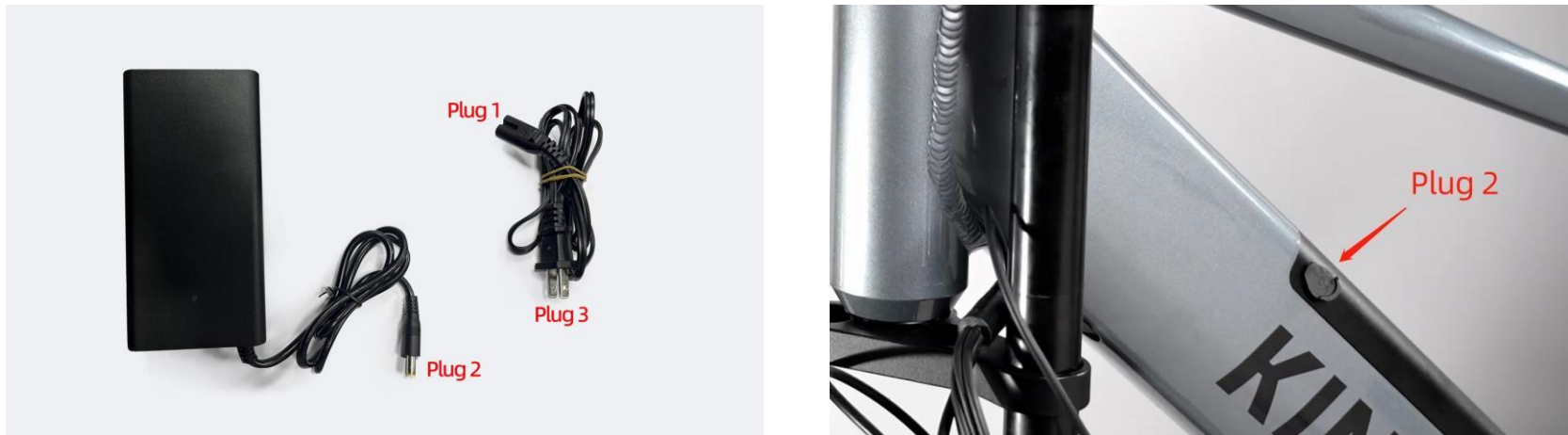

STEP3: Remove the rubber cover on the charging socket and insert the DC plug (Plug 2) of the charger into the battery charging socket.

STEP4: Connect the power plug (110/220 volt plug) to the power socket.

***This order helps extend the battery life and effectively reduces battery damage caused by improper charging.**

◆ Charging Procedure for Off-bike Charging

STEP1: Find the keys located on the handlebar and remove them. If you cut them from the handlebars, be careful not to damage any of the wires.



***Please keep your key and its spare in a safe place. Once lost, they are difficult to copy. The key number correlates to the number on the Keyhole.**

STEP2: Use the key to unlock the battery (fig. 5). Detach the battery by turning the release switch located on the right of the frame.



STEP3: Check the battery status:

Light Status	Battery Status
3 green lights & red lights	80%-100% power
2 green lights & red lights	60%-80% power
1 green lights & red lights	40%-60% power
Only red light	20%-40% power



STEP4: Safest way to charge your battery:

- Assemble the charger by inserting the plug (Plug 1) into the transformer.
- Insert the DC plug (Plug 2) into the battery charging socket.
- Insert the power plug (Plug 3: 110/220 volt plug) to the power socket.

This order helps extend the battery life and effectively reduces battery damage caused by improper charging.

The charger works on 110/220 V 56/60 Hz standard home AC power outlets. Do not open the charger to select voltage input as the charger can automatically detect and account for incoming voltage.

Project	Unit	Minimum	Max
Battery Input Voltage	V	28	55
Standby Current	mA		0.1



◆ After Charging

1. To check the battery status after charging, follow these steps:
 - a. First, unplug the main power supply by removing the plug from the power socket.
 - b. Then, disconnect the DC port from the battery.
 - c. You can now view the battery status on the display screen.
2. To install the battery after charging:
 - a. Hold the battery with one hand.
 - b. With your other hand, turn the release switch to properly install the battery.
 - c. Ensure that the battery is securely locked to prevent theft.

*If your battery shows abnormal charging behavior, such as:

- Longer-than-expected charge time
- Strange smell, smoke, or liquid emanating from battery and/or charger
- Overheating of the battery and/or charger

Please discontinue charging immediately and contact Kingbull Bike for assistance.

◆ Charging Tips

- The battery can be charged while attached to the bike or removed.
- A new battery might take longer to fully charge when it's completely depleted.
- The charger will automatically stop charging once the battery pack is fully charged.
- There's no need to worry about memory effects, you can recharge the battery after short rides.

◆ Precautions

- When charging, ensure the battery is kept away from direct sunlight, liquids, dirt, debris, and metal objects.
- Do not cover the charger during the charging process.
- Keep the charging battery out of reach of children.
- Always use an approved Kingbull Bike charger specifically designed for your bike's serial number, purchased directly from Kingbull Bike. Also, avoid charging in environments below 14°F (-10°C) or above 104°F (40°C).

◆ Before Riding

Ensure that the battery has been properly secured to the bike before each use by grasping the battery pack and pulling upwards to test the security of the pack.

◆ Battery Maintenance

- Avoid fully draining your battery. Turn off the power when the battery charge is low.
- Fully charge the battery after each use, regardless of how much power is used. This practice will prolong the battery life. If the battery power is not used for an extended period, store the battery with a full charge and remember to charge it once a month.
- The Kingbull Bike can be safely ridden in light rain. However, riding in heavy downpours or through flooded streets is not recommended, as the crank and/or motor can get wet, which may cause damage.
- Keep the battery away from open flame and other high-temperature heat sources. Avoid exposing the battery to direct sunlight and refrain from recharging it immediately after use in high-temperature weather.

***Making any modifications to the battery or motor is not recommended. Tampering with the battery will void Kingbull's warranty, and any issues arising from altered battery or motor will not be covered.**

Riding Modes

◆ Pedal-assist

Pedal-Assist is an operating mode on e-bikes designed to engage the motor to assist your pedaling effort, but not replace, your own pedaling effort. When you use your bike in pedal-assist mode, you can adjust the settings according to your preference. Kingbull provides five pedal-assist settings, ranging from 1 to 5.

- Higher pedal settings (L4/5) are most helpful for those who want to ride faster with minimal effort. These settings are perfect for individuals who aim to arrive at work feeling fresh and punctual, without becoming sweaty and exhausted.
- Lower pedal settings (L1/2) are popular among Kingbull riders for use after work or during leisurely rides. They are best suited for the commute back home from work, providing a refreshing way to destress after a full workday. Moreover, lower settings can extend the usable range for longer rides, enhancing enjoyment while minimizing physical stress and fatigue.

◆ Throttle-only

The throttle mode is similar to how a motorcycle or scooter operates, alleviating the need to pedal or providing an additional boost simply by twisting the throttle.

Kingbull Voyager can reach speeds of up to 25 miles per hour with throttle mode, which not only allows you to travel faster, but also reassures riders with extra power whenever needed, depending on traffic conditions and rider energy levels. If you are an adventurer who chases after speed and distance without compromising comfort or safety, the throttle-assisted Kingbull would be your perfect companion.

◆ Pedal-only

In this mode, the Kingbull will perform like a normal bike, as you'll be riding without any assistance from the motor. This mode is especially useful if you run out of battery, or are looking for more intensive resistance training.

We suggest that you select a lower assistance level when you first ride your Kingbull Bike. After becoming more comfortable with the riding characteristics of our e-bike, and more familiar with the varying range requirements of your most common destinations and commuting routes, you can then make any needed adjustments to pedal assist settings, as well as throttle use frequency, riding position, etc.

Riding Limitations

The following are some limitations that riders need to carefully consider in order to ensure that the hub motor does not overheat or become damaged from excessive loading:

- Do not attempt to ride up hills steeper than 15% grade.
- Use the pedals to assist the motor when climbing hills and accelerating from a stop.
- Avoid sudden starts and stops.
- Generally accelerate at a moderate pace, rather than aggressively.

Parking & Transport

To maintain the optimal condition of your bike, whether you're riding or storing it, adhere to these fundamental tips for parking, storage, and transportation:

- Turn off the power when walking with the bike to prevent accidental acceleration, or engage Walk Mode.
- While our bikes are water-resistant, avoid parking them outdoors in extremely cold or inclement weather for extended periods.
- When parking, switch off the power and lights to conserve battery. Remove the key, and ensure the battery is securely locked to the frame.
- When in public places, always secure your Kingbull Bike with a lock to prevent theft.
- Make sure not to park, store or transport your Kingbull Bike on a rack that is not designed for the size and weight of the bike. When storing or carrying your bike on a rack for transport, remove the battery to reduce the weight and make lifting or loading easier.

Safety and Care Instructions

To ensure safe riding conditions and maximize e-bike longevity, you must follow the guidelines outlined below:

- To clean the e-bike, wipe the frame with a damp cloth soaked in a mild, non-abrasive, non-corrosive detergent mixture. Wipe or spray all unpainted parts with anti-rust treatment after being used in coastal areas or areas with salty air or water.
- Never immerse the bike or any components in water, as the electrical system may be damaged. If the hub and bottom bracket bearings have been submerged in water, they should be removed and re-greased (this will prevent accelerated bearing deterioration).
- Periodically check wiring and connectors to ensure there is no damage, and the connections are secure.
- Store under shelter, avoiding extended exposure to cold or inclement weather. If exposed to rain or excess moisture, dry your bicycle afterward and apply anti-rust treatment to the chain and any other unpainted steel surfaces.
- Regularly clean and lubricate all moving parts, tighten components and adjust as required.
- Your cables, spokes, and chain will stretch after an initial break in period of 80-160 km, and additionally bolted connections can loosen with time and usage. Therefore, we suggest you contact a certified bicycle mechanic every two months to ensure your bike is safe and problem-free for years of use.
- If the paint has become scratched, or the metal chipped, use touch-up paint to prevent rust (clear nail polish can also be used as a preventative measure).
- Damage from corrosion is not covered under warranty, therefore special care should be given to protect and extend the life of your bike.

Maintenance

◆ Battery Maintenance

1. Don't fully drain your battery. Turn off the power when the battery charge is low.
2. Fully charge the battery after each use, no matter how much power is used. This will prolong the battery life. If the battery is not used for a long time, store the battery with a full charge and charge it once a month.
3. The Kingbull Bike can be safely ridden in light rain. However, it is not recommended to ride through very heavy downpours or flooded streets, as the crank and/or motor may get wet, leading to potential problems.
4. Keep the battery away from open flames or a high-temperature heat sources. Do not expose the battery to direct sunlight or recharge immediately after use in high-temperature weather.

◆ Motor Maintenance

1. Please check your motor frequently and tighten any loose screws or nuts, to prevent the vehicle from breaking down due to disconnected wires.
2. The brushless motors are not waterproof, so avoid riding through water deeper than the lower edge of the electric wheel hub to avoid motor failure.

◆ Chain Maintenance

1. We recommend cleaning the chain after each ride, especially in rainy and humid environments. Use a dry cloth to wipe the chain and its accessories clean. Use a brush to remove sand and dirt that may be stuck to the chain. If necessary, you can use warm soapy water. Avoid using strong acidic or alkaline cleaning agents, such as rust removers, as these chemicals may damage the chain.
2. After cleaning, apply lubricating oil to prevent rust. Ensure the chain is completely dry before applying the lubricating oil to the bearings.
3. To prevent unnecessary chain wear, try to maintain a vertical chain position when shifting gears (do not use the smallest gear with the smallest flywheel, or the largest gear with the largest flywheel, etc.).

◆ Front Fork Maintenance

1. Always use a clean, oil-free, lint-free cloth with plain or soapy water to clean your bike. To prevent water from flowing into the front fork, you can turn the bike upside down. Dry it with a lint-free towel after washing. Pay specific attention to the inner tube and the dust seal to reduce wear and prevent thinning of the inner tube, which can lead to significant damage if the aluminum is exposed to air.
2. We recommend using a dust cover for the front fork to protect the inner tube. This prevents dust from entering and also shields the inner tube from potential impacts with hard objects.

Warranty

Kingbull Bikes periodically updates our official Warranty Policy. Therefore, please review the latest policy on our website:

<https://www.kingbullbike.com/pages/warranty>



Customer Service Mail: customers@kingbullbike.com



Suggestion Box: evan@kingbullbike.com