

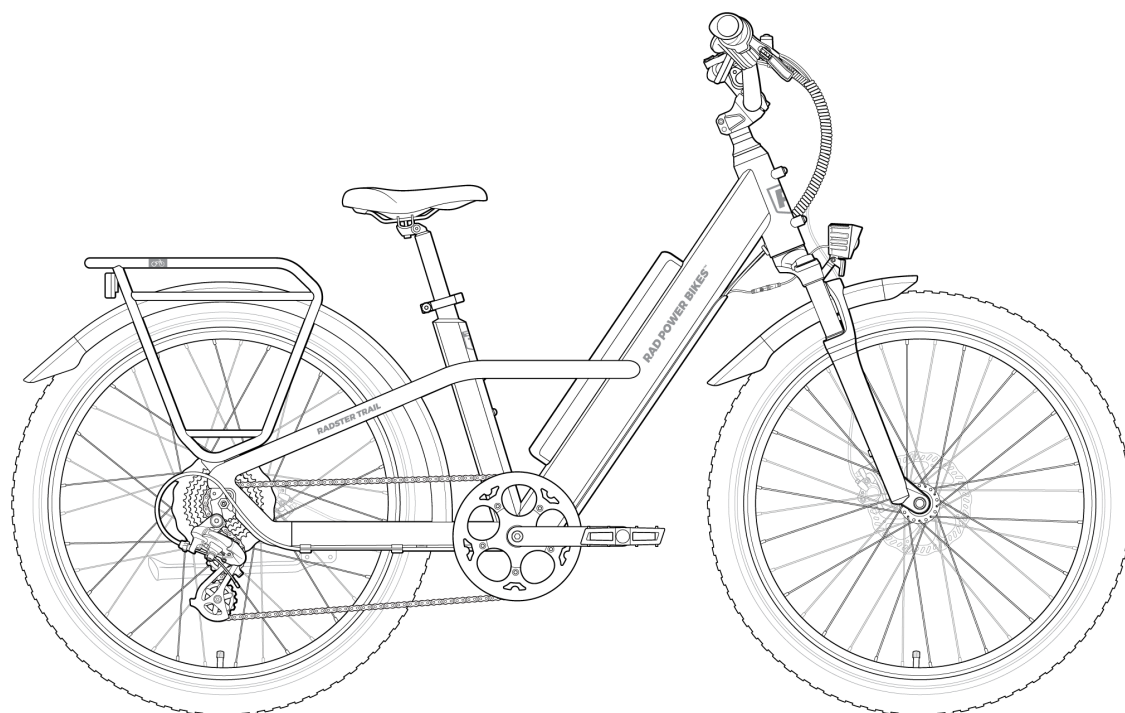



Radster™ Trail

OWNER'S MANUAL



Everyone at Rad Power Bikes cares about your safety and the safety of those around you. We want you to thoroughly enjoy your amazing ebike safely and reliably for many years to come.

SAFETY INSTRUCTIONS - SAVE THESE INSTRUCTIONS! Please read, understand, and follow all safety notices, cautions, and warnings in this manual.

 **WARNING:** DO NOT tamper with anything in your ebike's electrical system, battery, digital controls, physical components, or drive train. Tampering by altering or modifying any of these components may void your warranty, and any such modifications may result in damage to your ebike, other property, or injury or death to you or others.

 **WARNING:** This ebike is not to be operated by anyone under the age of 16. Children under the age of 16 may lack the necessary judgment and skill to safely operate the ebike, potentially resulting in damage to the ebike, damage to other property, serious injury, and/or death. Please also check your local laws, which may require a higher age. It is your responsibility to know and obey local regulations regarding rider age and other qualifications.



MINIMUM
OPERATOR AGE

 **DANGER:** Riding any bike, ebike, or similar vehicle without a helmet puts you at VERY HIGH RISK of serious head injury or death. Always wear a properly fitted helmet that covers the forehead. Many locations require specific safety devices. It is your responsibility to familiarize yourself and comply with the laws, rules, and regulations where you ride.



WEAR A HELMET

 **WARNING:** Ebike components like brakes, cables and tires may wear out faster than would be the case for non-motorized bicycles, requiring more service. You must check your ebike before each ride and according to the other checklists in this manual, and have a professional, reputable bike mechanic perform a thorough tune-up following the service intervals described here, or sooner if you discover increased wear. Failure to do so could result in property damage, serious injury, or death.



PRE-RIDE CHECK
rad-go.com/safety

Welcome to the Radventure!

Thank you for purchasing the Radster Trail from Rad Power Bikes™!

We take pride in bringing you a quality product that will offer years of enjoyment. Please read and understand this manual fully before assembling and riding your ebike. The latest version of your manual, your assembly video, and other helpful content is available at the QR code and URL at right.

Be sure to check all hardware for correct torque (see [“Tools and torque specifications” on page 11](#)) during assembly. Before each ride, follow the recommendations in the [“Safety checklists” on page 32](#). Finally, take care of your new Radster Trail by following the guidelines in [“Recommended service intervals” on page 35](#). If you're not sure you have the skills, experience, and special tools required for assembly and maintenance, get help from a local, professional, and reputable bike mechanic.



rad-go.com/assembly

WE ARE HERE TO HELP! If you have questions after reading this manual and watching the assembly video, please consult the Rad Power Bikes Help Center at radpowerbikes.com/help.

Thanks for riding Rad!

Contents

Welcome to the Radventure!	1
Using this manual	3
Assembly instructions for Radster Trail	5
Tools you need before you start	5
Assembly steps	5
Tools and torque specifications	11
Adjusting for comfort and safety	13
Seat angle and horizontal position	13
Seat height	13
Handlebar angle	14
Color Display angle	14
Brake lever angle	14
Brake lever reach	15
Suspension fork	15
Ensure all hardware is tightened properly	16
Battery information	17
Battery features	17
Safe operating temperatures	17
Removing and installing the battery	18
Before you charge	18
Charging procedure	19
Estimated charging times	20
Estimated range per full charge	21
Best practices for extending range and battery life	21
Battery storage	21
Summary: Battery recommended temperatures	22
Additional critical battery safety information	22
Operating instructions	24
How the electrical system works	24
Handlebar features	24
Color display functions and electrical controls	25
Brake light	27
Start-up procedure	27
Moving and storage instructions	28
Carrying cargo or a child	29
Weight limits	29
Carrying loads (cargo or passengers) safely	29

Carrying passengers	30
Carrying pets	31
Safety checklists	32
User maintenance instructions	35
Check and service your ebike regularly	35
Recommended service intervals	35
Checking brakes and motor cutoff switches	36
Tire and wheel care	37
Handlebar twist and push tests	38
Guard against rust, corrosion, and water damage	39
Troubleshooting	39
Error detection	40
Ride as safely as possible	42
Age and ability requirements	42
Know and obey all relevant local laws	42
Ride appropriately for conditions	42
Wear a helmet and appropriate safety gear	44
Limited Warranty Terms	45
Warranted Products	45
Limited Warranty Labor	45
Wear and Tear	45
This Limited Warranty Does Not Cover	46
Claims Process	46

Using this manual

This manual contains critical details about how to safely operate and maintain your Radster Trail. Read it carefully and familiarize yourself with your ebike before riding it. Pay special attention to the safety messages shown here.

 **NOTICE:** A “notice” is important information that can help you avoid ebike/property damage or extend the life of parts and the ebike.



CAUTION: A “caution” indicates a hazardous situation that, if not avoided, could result in minor or moderate injury or property damage.



WARNING: A “warning” indicates a hazardous situation that, if not avoided, could result in death, serious injury, or property damage.



DANGER: A “danger” statement indicates a hazard that, if not avoided, has a very high risk of death, serious injury, or property damage.

Operating any bike, trike, or other vehicle always involves some risk of serious injury or death. Your safety depends on many factors including your skill, your ebike’s maintenance, and riding conditions. There are also factors you cannot control or anticipate. This manual makes no representations about the safe use of this product under all possible conditions. If you have any questions, contact Rad Power Bikes immediately.

Assembly and first adjustment of your ebike from Rad Power Bikes requires special tools and skills. We strongly recommend that you have this done by a professional, reputable bike mechanic, or have them inspect your work if you choose to do it yourself. Keep this manual and any other documents that came with your Radster Trail. All content in

this manual is subject to change or withdrawal without notice. Visit radpowerbikes.com/help to view and download the latest version. Rad Power Bikes makes every effort to ensure the accuracy of its documentation and assumes no responsibility or liability if any errors or inaccuracies appear within.

Assembly instructions for Radster Trail

The following steps provide an overview of how to assemble your Radster Trail from Rad Power Bikes. If you're reading a printed version of this manual, it may not be current. Please download the latest version of your manual, which may contain important safety updates, and view your ebike's assembly video by going to radpowerbikes.com/help.

You must read and understand the entire manual and any documentation provided for sub-components or accessories before assembly, maintenance or riding your ebike.

Tools you need before you start

Your Radster Trail comes with many but not all of the tools you will need for assembly. In addition to the provided tools, you will need the following:

- **Flat-side cutters.** These are useful for snipping zip ties and much safer than tools like box cutters.
- **Torque wrenches with Allen bits.** For assembly and maintenance, you will need a torque wrench kit capable of adjusting bolt heads across a range of torque values (0 to 60 Nm) to ensure your bike is safe to ride.
- **15 mm pedal wrench or crowfoot bit.** Regular wrenches are too wide to fit between pedal and crank, and may make it impossible for you to properly secure your pedals without damaging them or your cranks. A 15 mm pedal wrench will fit properly, and an experienced mechanic can use such a tool to correctly tighten pedals to 35 Nm. If you do not have that level of skill, you'll need a crowfoot bit (shaped like the end of a pedal wrench) to use with your torque wrench to secure your pedals to 35 Nm.
- **Bicycle grease.** Necessary to lubricate and/or prevent corrosion on certain parts.
- **A clean shop towel or paper towel** for cleaning excess grease.
- **Bicycle floor pump with Schrader valve and pressure gauge.** Properly inflated tires are a must for safety, comfort, and performance.
- **A strong friend.**

What is torque? Torque is rotational force. In the bike industry, torque is typically measured in units of Newton meters (Nm). Applying the right amount of torque to your fasteners (bolts, nuts, etc.) is critical for your safety. To torque accurately, use a high-quality torque wrench. Torque wrench accuracy depends on your technique (e.g., wrench angle and grip location), so be sure to read the instructions that came with your torque wrench.

If you plan to do your own tune-ups, repairs, and other maintenance, please refer to [“Tools and torque specifications” on page 11](#) for information on other tools needed for servicing certain components on your Radster Trail. If you do not wish to acquire these tools for assembly and maintenance, we strongly recommend that you seek professional help to assemble and maintain your ebike.

Assembly steps

 **WARNING:** Incorrect assembly, maintenance, or use of your ebike can cause component or performance failure, loss of control, serious injury, or death. Ebikes have parts that non-motorized bikes do not have, and neither the assembly video, assembly steps, or the rest of the manual cover all potential aspects of ebike configuration, maintenance, and repair, which can require specialized tools and skills. We strongly recommend you consult a professional, reputable bike mechanic to assist in the assembly, repair, and maintenance of your ebike, or inspect your work if you choose to do it yourself.

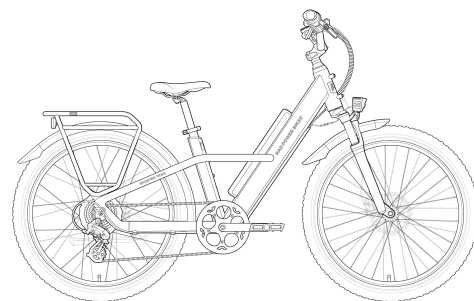

Fully assembled Radster Trail

Please note that your ebike may include components that look different from those in this manual's illustrations. Such changes help ensure uninterrupted production and shipping. Our engineers rigorously test each component to guarantee quality and compatibility.

1. **Unpack the ebike.** Use flat-side cutters to remove any packing straps from the box, remove the four plastic handle tabs on the outside of the box, and then remove the box top and set the ebike on a flat surface for assembly. Carefully remove the packaging material protecting the bike frame and components. Keep the packaging materials in case you need to ship the bike later. Otherwise, recycle these materials, especially cardboard and foam, wherever possible.
2. **Ensure all of the following items are included with the ebike.** Smaller pieces are included in the accessory box.

<ul style="list-style-type: none"> • Front wheel • Front wheel thru-axle (in fork protector plate) • Front fender 	<ul style="list-style-type: none"> • Headlight • Assembly toolkit • Charger • Pedals (left and right) 	<ul style="list-style-type: none"> • Keys (2) • NFC (near field communication) cards (2) • Owner's Manual • Rider Quick Reference Card
--	---	--

If anything is missing, please contact Rad Power Bikes.

3. **Orient the front fork properly.** The brake caliper should be on the rider's left side of the bike, and there should be no cables twisted around the head tube.

4. **Install the handlebar.**

a. **Remove the stem faceplate and hardware.**

Use an Allen wrench to unthread the stem faceplate bolts, and then remove the faceplate and set aside.

- b. **Orient the handlebar properly.** Mount the handlebar on the stem. The brake levers should face forward and the throttle should be on the right side. Trace the brake housing from the left brake lever to the front brake caliper and make sure the bundle of cables is not twisted.

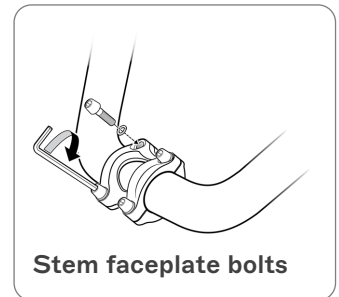
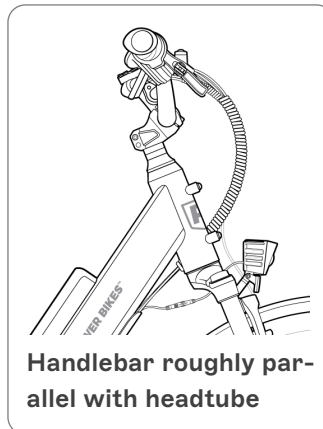

- c. **Center the handlebar on the stem.** Place the handlebar into position on the stem so it's centered. Your handlebar has the widest diameter at its center. If it isn't centered, it could come loose. Tilt the handlebar so that it is roughly parallel with the headtube when viewed from the side (see illustration). You can adjust the handlebar angle to your desired position later once you've had a chance to take a test ride.

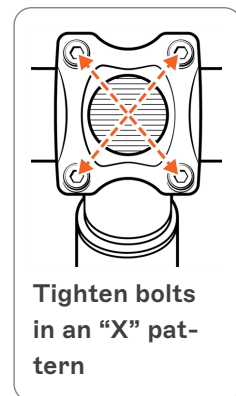

- d. **Install the stem faceplate.** Place the stem faceplate over the handlebar, and thread in the four bolts by hand. Then use the Allen wrench to tighten the bolts. Tighten each a little at a time, moving in an "X" pattern, to ensure they tighten evenly. Ensure the gap between the faceplate and stem is even.

- e. **Torque the bolts evenly.** Move in an "X" pattern again, and use the torque value listed in ["Tools and torque specifications" on page 11](#). If you decide to adjust the angle of the handlebar later (e.g., to bring it slightly closer to the seat), follow the same procedures listed here to ensure the handlebar is properly secured.



WARNING: Do not overtighten the stem faceplate bolts or stem clamp bolts beyond the torque values listed in this manual, as this can result in component failure, which can lead to property damage, serious injury or death.

5. **Install the front wheel onto the front fork** as explained below.



WARNING: Do not touch the brake rotor, which has sharp edges and can cause serious injury. Touching the brake rotor or brake pads with bare skin can also transfer natural oils. Oils or other lubricants can decrease braking performance. We recommend wearing protective gloves when working near the braking system.



- a. **Remove the thru-axle.** Use an Allen wrench to turn the thru-axle bolt in a counterclockwise motion to unthread from the fork and fork protector plate, and then fully remove the thru-axle and set aside for now. Remove the fork protector plate and recycle according to local rules.

- b. **Remove the hydraulic brake pad spacer** from the brake caliper on the front fork.

NOTICE: When the front wheel is not installed and the hydraulic brake pad spacer is absent, do NOT squeeze the brake levers. Doing so can cause the brake pads to clamp together too much and prevent the brake rotor from fitting between the pads. If this happens to you, install the brake pad spacer back between the pads to create more space between the brake pads for the brake rotor.

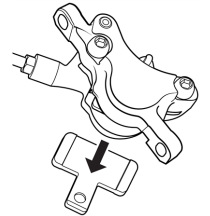

- c. **Carefully lower the fork onto the front wheel.** Guide the fork arms on to the wheel so that the hub fully enters the indented slots on the inside of the fork arms. Pay attention to the brake rotor--it needs to slide between the brake pads evenly.

NOTICE: The front wheel hub has black end caps on both sides of the hub that align with the slots on the inside of the fork. If either of these end caps have come off during shipping, reinstall them on the hub to ensure a secure fit during assembly (see illustration below).

- d. **Install the thru-axle.** Insert the thru-axle through the drive side of the fork and wheel, and push all the way until you can thread by hand into the other side of the fork. Use the Allen wrench to slowly turn in a clockwise motion to fully thread into the fork until secure.

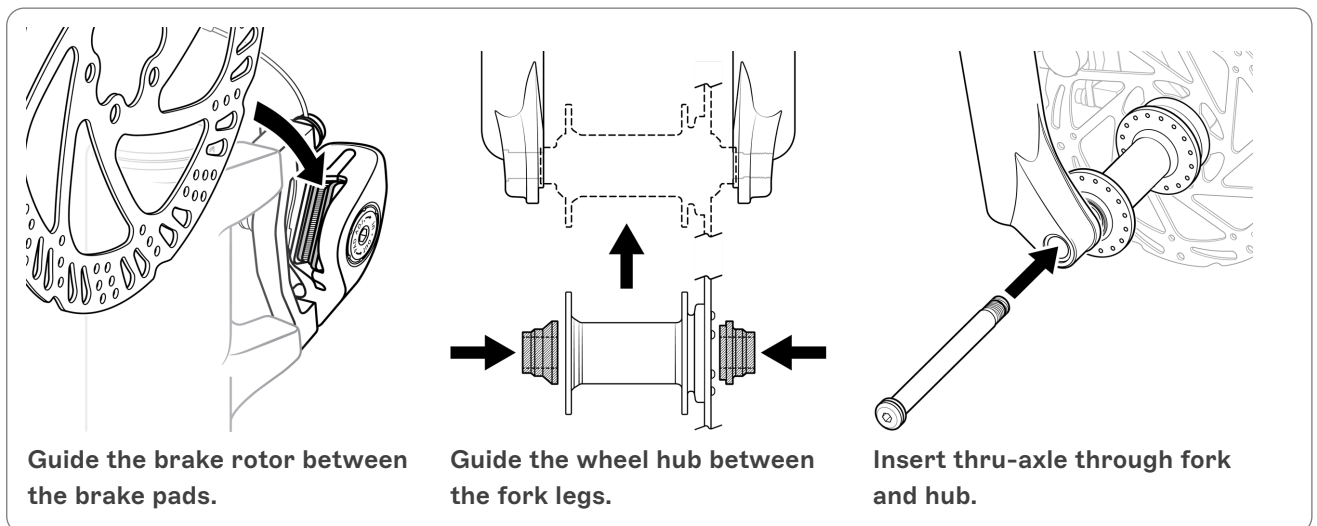

- e. **Torque the thru-axle.** Use a torque wrench with an Allen bit to torque the thru-axle to the value listed in [“Tools and torque specifications” on page 11](#)).
- f. **Test your front wheel installation** using these tests:
- With a friend holding the front of the bike up, spin the front wheel to ensure it has no wobble or looseness.
 - While straddling the bike with hands on the handlebars, squeeze the front-brake lever with your left hand. Rock the bike forward and backward. Ensure the front brake prevents the front wheel from spinning and that there's no play or wiggle in the wheel, handlebar, or front fork.
- g. **Check the security of the rear wheel.** You must also check the torque value of the rear wheel axle nut to ensure it's correctly tightened to the value listed in [“Tools and torque specifications” on page 11](#)).



WARNING: An improperly secured front or rear wheel can cause loss of control, accidents, serious injury, or death. Check that the wheels are properly secured during assembly and before each ride.

6. **Perform a handlebar twist and push test** to ensure the front wheel and handlebar stem are securely connected. Instructions for doing so are in [“Handlebar twist and push tests” on page 38.](#)
7. **Put the kickstand down.** Put the kickstand down for the rest of the assembly.
8. **Install the front fender and headlight.**

- a. **Locate the front fender and headlight.** The front fender was attached to the front wheel for shipping, and the headlight is in the accessory box.
- b. **Remove the headlight mounting hardware** from the fork bridge.
- c. **Position the front fender.** Pass the fender from the back of the wheel, forward under the fork bridge.
- d. **Install the fender/headlight mounting hardware.** Pass the bolt with a split washer and flat washer through the back of the headlight mounting bracket and the fender bracket, and then thread into the mounting point on the rear of the fork by hand. Use an Allen wrench to tighten the bolt until secure.
- e. **Check that the fender and headlight are centered.** The wheel should spin freely within the fender without touching it.

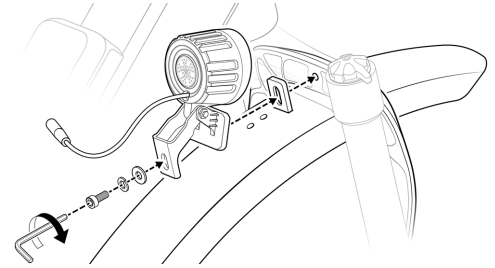

Mount headlight and fender to front fork



WARNING: A loose or improperly installed fender can interfere with the wheel or other moving parts, creating a risk of component damage, serious injury, or death.

- f. **Torque the mounting bolt** according to the value listed in [“Tools and torque specifications” on page 11.](#)
9. **Plug in the headlight connector.** Line up the internal notch and pins with the external arrows, and press directly together without twisting.
10. **Adjust the headlight angle slightly downward** so it won't blind oncoming traffic. Using the tools listed in [“Tools and torque specifications” on page 11,](#) loosen the angle adjustment bolt and locknut, angle the headlight downward, and tighten securely. Do not overtighten.

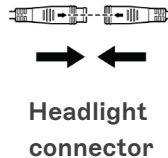

Headlight connector

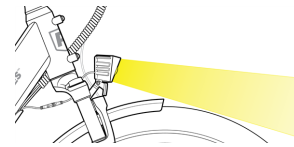

Headlight pointing slightly downward to not blind others

11. **Install the pedals.**

- a. **Locate the right-side pedal,** which is marked “R,” should have an “R” sticker attached, and has a smooth pedal axle. The right pedal goes on the crank on the drivetrain side of the bike, which has the chain and is the same as a rider's right side when seated on the bike.
- b. **Place a pea-size or slightly smaller amount of bicycle grease onto the threads of the right pedal.**
- c. **Carefully thread the right pedal onto the right crank by turning clockwise** (toward the front of the bike). Do so slowly and gently by hand. Do not cross thread or damage the threads. See the [“Right pedal installation”](#) illustrations.

RIGHT PEDAL INSTALLATION

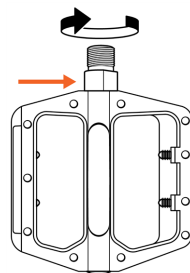

Right pedal with smooth pedal axle.

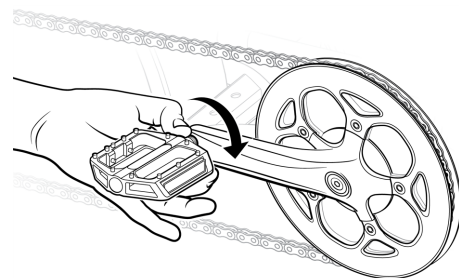

Thread the right pedal onto the right crank gently by hand, turning clockwise.

- d. Place a pea-size or slightly smaller amount of bicycle grease onto the threads of the left pedal.
- e. Carefully thread the left pedal onto the left crank by turning counterclockwise (toward the front of the bike). The reverse-threaded left pedal is marked with an “L,” should have an “L” sticker attached, and has notches on the pedal axle. Thread slowly and gently by hand without cross-threading or damaging the threads. See the [“Left pedal installation”](#) illustrations.
- f. Tighten each pedal using a pedal wrench. You can also use a torque wrench with a crowfoot bit for this task, but regular wrenches won’t fit in the narrow space and may damage your pedal or crank.
- g. Torque each pedal to 35 Nm. An experienced mechanic can torque properly with a pedal wrench, but if you’re less experienced, use a torque wrench with a crowfoot bit.
- h. Wipe off any excess bicycle grease.

LEFT PEDAL INSTALLATION

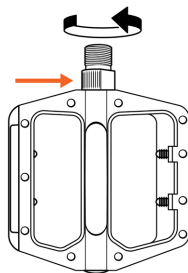

Left pedal with notches on the pedal axle.

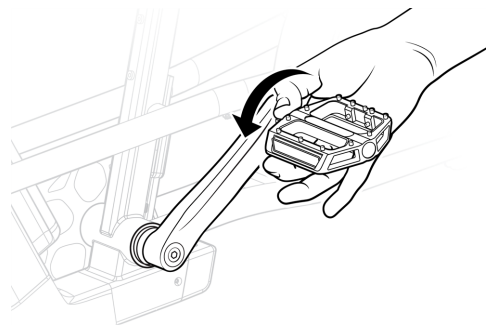

Thread the left pedal onto the left crank gently by hand, turning counterclockwise.

PEDAL WRENCH USE

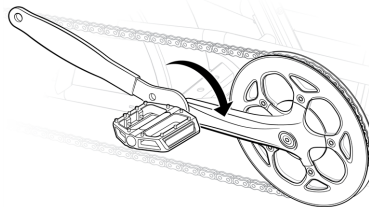

Right pedal: clockwise

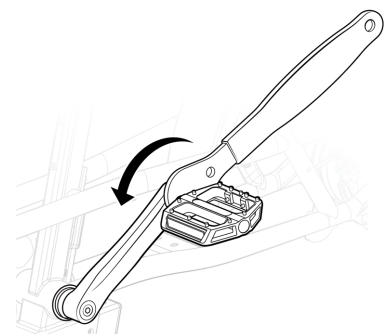

Left pedal: counterclockwise



WARNING: Improperly or inadequately tightened pedals can fall off your bike while you’re riding, leading to component damage, serious injury, or death. If you aren’t sure how to tighten your pedals or don’t have appropriate tools, please get help from a professional mechanic.

12. Inflate the tires.

- a. **Inspect tires for damage.** Check the tire sidewalls, beads and treads for any damage before inflating. If you discover any damage, contact our product support team for assistance.
- b. **Ensure the tube is fully seated in the tires.** If you cannot squeeze the tire enough to check the tube position, deflate the tire further by removing the valve cap, and then press and hold the inner valve core to let some air out.
- c. **Check tube nesting within tires.** Lift the wheel and squeeze the tire while gently rocking back and forth to ensure the tube is fully seated and not pinched anywhere between the tire and rim, and the tire bead is evenly seated within the rim. Repeat this process on the other side of each tire.

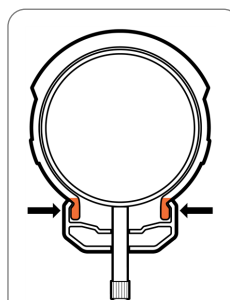

The bead is the hard, rounded end of the tire that goes into the wheel rim.

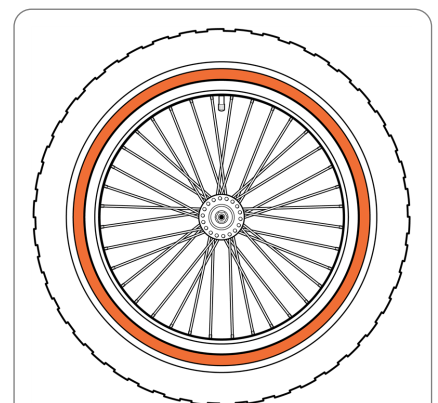

Visually inspect the sides of the tires, using the lines and markings on it as a reference to ensure the bead is inserted into the rim fully and evenly.

- d. **Inflate tires to recommended PSI.** Use a floor pump with a Schrader valve and pressure gauge to inflate each tire to the recommended PSI (pounds per square inch) indicated on the tire sidewall. Add a small amount of PSI at a time and verify that the tube is still nested within the tire properly and the tire bead is not out of alignment with the rim. Bounce the tire to help seat the tire bead more evenly (if necessary). If you discover the tube getting pinched between the tire and rim at any point, deflate the tire and start the process over again. Do not overinflate or underinflate tires. Once you've had a chance to take a test ride, you can adjust the PSI for your desired riding terrain and comfort level. For more information, see [“Tire and wheel care” on page 37.](#)
13. **Check the chain alignment.** Stand at the right side of the bike and grab the right pedal. Rotate the right pedal and crank toward the back of the bike as though pedaling backward—this will run the chain through the drivetrain without spinning the wheels. Watch the chain and ensure the chain runs through the drivetrain (the free-wheel, derailleur, and around the front chainring) smoothly. If the chain doesn't run smoothly or something seems misaligned, please consult our online Help Center (radpowerbikes.com/help).
14. **Activate your battery.** Your battery has arrived in “ship mode,” which prevents power from deploying to the motor during shipping. To exit ship mode, press and hold the battery button for at least three seconds.
15. **Prepare your ebike for use.**
- Complete all steps** in “Adjusting for comfort and safety” on page 1, including checking that all hardware has been tightened according to the values in [“Tools and torque specifications” on the next page.](#)
 - Configure display and security settings** as described in [“Color display functions and electrical controls” on page 25](#)
 - Perform the safety checks** in [“User maintenance instructions” on page 35](#) including the handlebar twist and push test in [“Handlebar twist and push tests” on page 38.](#)
 - Place the Rider Quick Reference card.** If you're assembling the ebike on behalf of the operator, be sure to use the supplied zip ties to attach the Rider Quick Reference card to the handlebars as shown in the illustration. If you are the operator, read the card and post it someplace for easy reference. We recommend hanging it with the Safety Check side facing out near wherever you prep your ebike before each ride.
 - Power on the ebike** as described in [“Start-up procedure” on page 27](#) and Ride Rad!

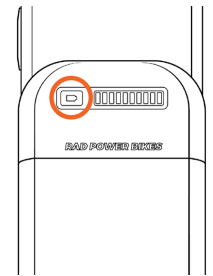

Battery button

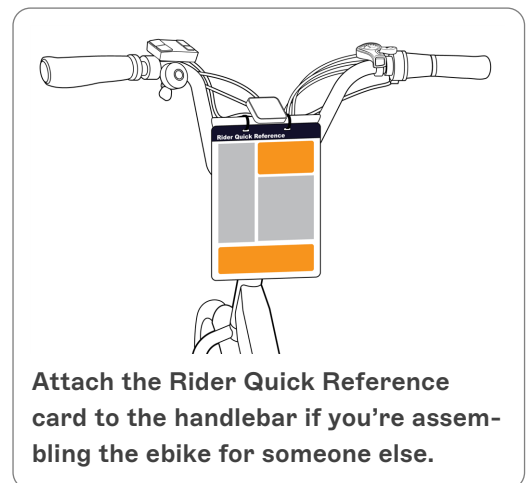

Tools and torque specifications

Applying the right amount of torque to your ebike fasteners (bolts, nuts, etc.) is critical for your safety. Brake components must be torqued to the values listed here, unless a professional, reputable bike mechanic has inspected them and advised otherwise. Fasteners can loosen over time with normal usage, so it is important to periodically check these torque values.

To “torque” accurately, use a high-quality torque wrench. Torque wrench accuracy depends on your technique (e.g., wrench angle and grip location), so be sure to read the instructions that came with your torque wrench. The tool sizing listed below is a general guide, but it is possible that the head of a particular bolt on your ebike may vary, requiring a different tool (e.g., a 4 mm Allen wrench instead of a 5 mm Allen wrench). If so, use whatever tool fits the bolt head. Such differences will not affect the torque value for that piece of hardware.

If you are installing accessories from Rad Power Bikes, any necessary instructions, important safety information, and torque specifications will come with your accessory and/or be available online at radpowerbikes.com/help.



WARNING: Do not overtighten any bolts or fasteners beyond the values listed here, as this can result in component failure, which can lead to property damage, serious injury or death.

		Tool	Rec. torque
Handlebar area	Stem faceplate bolts	5 mm Allen	8-10 Nm
	Stem clamp bolts	5 mm Allen	13-15 Nm
	Shifter clamp bolt	5 mm Allen	6 Nm
	Throttle clamp bolt	3 mm Allen	3-4 Nm
	Color Display clamp bolts	4 mm Allen	tighten securely
	Remote clamp bolts	3 mm Allen	tighten securely
	Brake lever clamp bolts	5 mm Allen	6-9 Nm
	Grip bolts	3 mm Allen wrench	3-4 Nm
	Bell	Phillips screwdriver	tighten securely
Front wheel area	Thru-axle	6 mm Allen	8-10 Nm
	Headlight angle adjustment bolt	Phillips head screwdriver and 8 mm wrench	tighten securely; do not over-tighten
	Headlight/front fender mounting bolt	5 mm Allen	8-10 Nm
Brake areas (front and rear)	Caliper to frame bolts	5 mm Allen	6-8 Nm
	Brake pads to caliper	Needle-nose pliers	90 degree bend at tip of cotter pin
	Brake rotor to hub	T25 Torx bit	6-8 Nm
Seat area	Saddle adjustment bolt	6 mm Allen	13-15 Nm
	Saddle mount nut	6 mm Allen	9-10 Nm
Frame downtube	Battery tray	Phillips head screwdriver	tighten securely
	Controller mounting bolts	3 mm Allen	2-3 Nm
	Controller cover mounting bolts	3 mm Allen	tighten securely
	Frame cable cover bolts	3 mm Allen	tighten securely
Rear rack area	Rear rack to Frame mounting bolts	5 mm Allen and 10 mm wrench	8-10 Nm
	Rear fender mounting bolts	3 mm Allen	4-5 Nm
	Taillight	8 mm wrench	3-4 Nm

Rear dropout area	Rear axle nuts	21 mm wrench	55-65 Nm
	Torque arm bolt	4 mm Allen	5 Nm
	Derailleur hanger mounting bolt	5 mm Allen	6 Nm
	Derailleur mounting bolt	5 mm Allen	10 Nm
	Derailleur cable clamp bolt	5 mm Allen	6-8 Nm
	Kickstand	5 mm Allen	8-10 Nm
Bottom bracket and crank area	Pedal into crank arm	15 mm pedal wrench	35 Nm
	Crank arm removal info	Crank puller for square taper bottom bracket	n/a
	Crank arm bolt into bottom bracket spindle	8 mm Allen	40-45 Nm
	Chainring bolts	6 mm Allen	8-10 Nm
	Bottom bracket and cups	BBT-9 Park Tool	40-45 Nm

Adjusting for comfort and safety

The following steps are critical for your comfort and safety, and **must** be performed before your first bike ride. We recommend that you consult a bike fitting professional such as a certified, reputable bike mechanic who specializes in bike fit.

Seat angle and horizontal position

Many riders prefer the seat to be roughly parallel to the ground, with its horizontal position in the middle of the range marked on the seat rails. To change the angle and horizontal position of the seat:

1. Use an appropriate size Allen wrench to loosen (but do not remove) the seat adjustment bolt on the clamp located underneath the seat.
2. Move the seat backward or forward and tilt to adjust the angle. Do not exceed the limit markings etched into one of the seat rails, which show how far you can safely move the seat forward and backward.
3. Ensure the top of the seat rail clamp is aligned directly over the bottom of the clamp so that the seat adjustment bolt will clamp the seat rails properly. Then, while holding the seat in the desired position, use the Allen wrench to tighten the seat adjustment bolt securely to the torque value listed in [“Tools and torque specifications” on page 11](#).

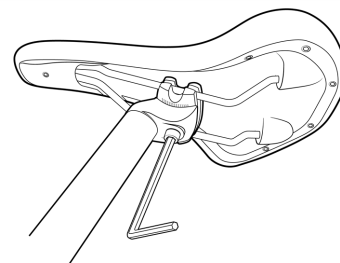

Seat adjustment bolt, Allen wrench

WARNING: A loose seat clamp or seat adjustment bolt can cause loss of control, ebike/property damage, serious injury, or death. Prior to first use, be sure to torque the seat adjustment bolt according to the specification in [“Tools and torque specifications” on page 11](#). Regularly check that bolt and make sure that the clamp on the underside of your seat is secure on the seat rails.

Seat height

An ideal seat height will allow you to be comfortable and get the best pedaling efficiency. When you are seated, you should be able to place the ball of your foot on the pedal at its lowest position while your leg is almost fully extended, with your knee slightly bent. The seat should never be so high that you need to rock side to side or fully straighten your legs while pedaling. Never pull out the seatpost so far that the minimum insertion point is visible above the seat tube (see illustration).



Seatpost out **TOO FAR**

The minimum insertion point on the seatpost must be inserted into the seat tube.

Depending on your preference, ability, and amount of experience with bike and ebike riding, you may find that lowering the seat so you can put one or both feet on the ground without dismounting may offer a safer and more comfortable experience.

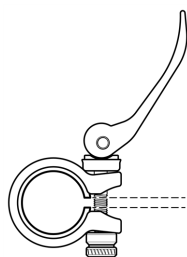

Open the quick-release lever

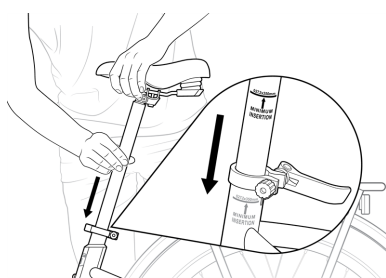

Insert the seatpost, ensuring the minimum insertion point goes into the seat tube.

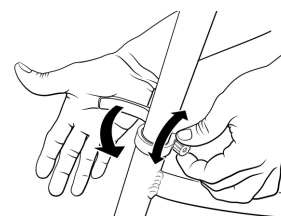

Close the quick-release lever using your palm.

1. **Open the seatpost quick-release lever.**
2. **Slide the seatpost in or out of the seat tube** to a height appropriate for your leg length and preference. *Do not extend the seatpost beyond the minimum insertion marking etched onto the seatpost* (see the [“Seatpost out TOO FAR”](#) illustration).
3. **Align the quick release clamp opening with the notch in the seat tube, and close the quick-release lever fully.** Closing the lever should require enough pressure that it leaves an imprint in your hand. When closed, the seat should not move up, down, left, or right. If needed, adjust the lever tension by turning the adjustment nut opposite the quick-release lever.



WARNING: A loose seatpost can cause your seat to drop suddenly, which can lead to loss of control, component damage, serious injury, or death. Regularly check to make sure that your seat’s quick-release lever is properly tightened.

4. **Try out your seat fit,** and repeat steps 1–3 if the seat position needs a bit more adjusting.



DANGER: Overextending the seatpost can cause it to break or fall off your ebike, which will put you at very high risk of serious injury or death. Avoid this danger by inserting your seatpost into the seat tube far enough that the minimum insertion point is no longer visible.

Handlebar angle

Most riders will feel comfortable with the handlebar angled so that it is roughly parallel with the front fork, as shown in the more vertical position of the illustration. Once you have adjusted the seat to your leg length and preference, you may decide that you would like the handlebar to be angled slightly closer to the seat. If so, follow these steps.

1. **Loosen the four stem faceplate bolts** just enough to allow the handlebar to pivot, and position it as you prefer.
2. **Re-tighten the stem faceplate bolts** using the method described in the assembly instructions.
3. **Test the positioning by sitting on the bike,** making sure it’s comfortable and that the handlebar can turn freely without touching your body.
4. **Inspect the stem faceplate bolts.** Be sure the gap between the faceplate and stem at each bolt is even and torque all faceplate bolts according to the value listed in [“Tools and torque specifications”](#) on page 11.
5. **Test the security of your handlebar by performing a handlebar twist and push test.** See [“Handlebar twist and push tests”](#) on page 38.

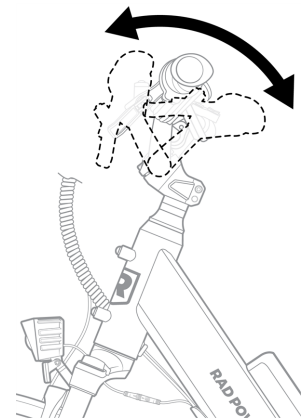

Color Display angle

For best screen visibility and to prevent glare, angle the Color Display so that it does not face you directly, but tilted slightly away from you when you’re seated and riding.

1. **Loosen the Color Display clamp bolts.** Loosen just until the display can rotate on the handlebar. Do not remove the bolts.
2. **Rotate the Color Display and test the positioning.** The angle that will minimize glare and optimize visibility of the screen will depend on the rider’s height and biking position. Tilt away from the rider, but not so far that it’s horizontal. Test the position while seated on your bike outdoors, in sunlight. Adjust as desired.
3. **Tighten the Color Display clamp bolts.** Tighten to the torque value listed in [“Tools and torque specifications”](#) on page 11.

Brake lever angle

The angle of the brake levers can be adjusted for the most comfortable hand position possible. For most riders, this will allow them to rest two or three fingers comfortably on the brake lever while keeping their wrists in a neutral position. To adjust the angle, follow these steps:

1. **Loosen the brake lever clamp bolt** using the appropriate Allen wrench.
2. **Adjust the angle of the brake lever** so it's comfortable for the rider.
3. **Retighten the brake lever clamp bolt** according to the value listed in [“Tools and torque specifications” on page 11.](#)

Brake lever reach

You can also adjust the brake lever reach (how *close* the brake levers are to the handlebar grips). For most riders, the default position of the brake levers will be comfortable. For others, especially those with small hands or sensitive joints, it may be more comfortable to move the brake levers closer to the handlebar. Here's how:

1. **Locate the brake lever reach adjustment screw** behind the brake lever (see the illustration above).
2. **Rotate the screw using an appropriate size Allen wrench.** Rotate in a clockwise direction to move the lever further from the grip. Rotate counterclockwise to bring the brake lever closer to the grip. Be sure not to adjust the brake lever reach so close to the grips that the lever hits the grips when you apply your brakes.
3. **Test brakes.** After the lever reach is adjusted, test the brakes either on a repair stand or in a safe area at low speed.

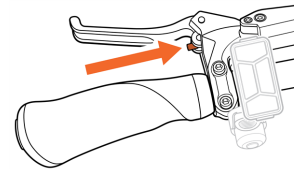

Brake lever reach adjustment screw

! DANGER: Always ensure your brake levers can't touch the handlebar grip when you squeeze firmly. A brake lever that can touch the grips may not engage the brakes fully, causing you to have difficulty slowing or stopping and putting you at very high risk of serious injury or death. Squeezing the brake lever halfway toward the handlebar grip must cause the brake pads to press firmly against the brake rotor. If you think your brakes may not be functioning properly, do not ride your ebike. Refer to our Help Center for more information (radpowerbikes.com/help).

Suspension fork

The suspension fork can move up and down to cushion bumps in the riding surface, which can make riding on a rough road or trail smoother and more comfortable. Depending on your weight or preference, you can adjust the preload (suspension fork spring compression).

! WARNING: A low preload setting (for a “softer” ride) can cause your fork to compress when you brake, and the effect will be more dramatic for heavier riders, bikes with a lot of cargo (especially in front), and at higher speeds. If the fork compresses suddenly, that could cause loss of balance or a fall, resulting in serious injury or death. We recommend you start riding with a higher preload setting. If you want to try a lower preload, practice riding at that setting in a safe location (flat and free of hazards that might require sudden braking) and begin at low to moderate speeds.

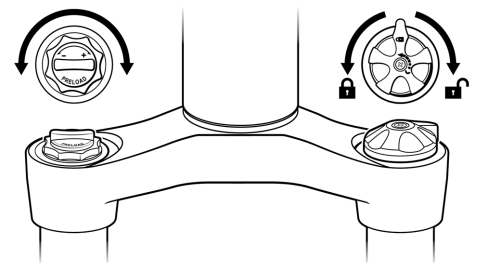

Suspension fork

The suspension fork can also be locked out as a rigid fork, which will typically yield higher pedaling efficiency.

To lock the suspension fork, turn the lockout lever counterclockwise. To unlock the suspension fork, turn the lever clockwise until it stops.

To adjust the preload of the suspension fork, follow these steps:

1. **Make sure the lockout lever is unlocked.**
2. **Turn the preload adjustment knob.**
 - To *subtract* preload (to make the suspension *softer*), turn the preload adjustment knob in the direction of the small “-” on the knob. A softer ride can be best for lighter riders or those who prefer maximum cushioning from bumps in the riding surface.
 - To *add* preload (to make the suspension *stiffer*), turn the preload adjustment knob in the direction of the small “+” on the knob. A stiffer ride can be better for heavier riders or those who prefer a stiffer, more efficient ride.

For more information on adjusting suspension forks, please see our Help Center at radpowerbikes.com/help.

Ensure all hardware is tightened properly

Ensure all hardware is tightened properly according to the values in [“Tools and torque specifications” on page 11](#).

This is a critical safety step that you must not skip. If you do not own a torque wrench or you do not have the skills to check the tightness of your hardware, consult a local, professional, reputable bike mechanic for help. You can find more information about bike fit and making adjustments to your ebike in our Help Center at radpowerbikes.com/help.

Battery information

The battery that comes with your Radster Trail is a state-of-the-art, lithium-ion battery that's designed to give you years of power with proper care and use. Follow the recommendations here for the best possible performance.

Battery features

Please familiarize yourself with all of the components of your battery. When you are seated on your ebike, the charging port of your battery will be on the right side of the battery.

CHARGE LEVEL

On the top of your battery there is a button and 10 charge indicator LED lights. When you press the button, the LEDs will give you an approximation of your charge level: zero lights indicate zero or nearly zero charge, one light indicates about a 10% charge, two lights indicate about a 20% charge, and so on. When the battery is nearly empty, the first LED will blink.

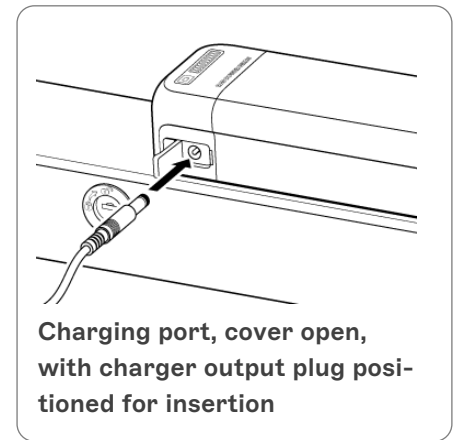
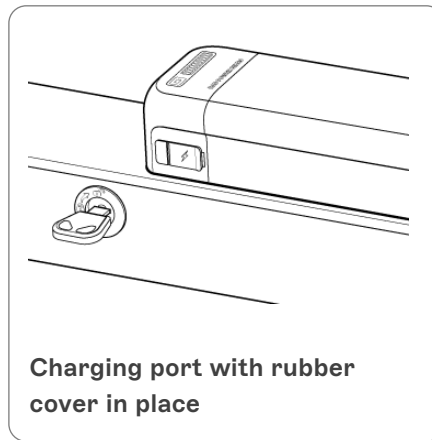

NOTICE: If you press your battery button and none of the LEDs light up, it's possible your battery is in ship mode. (If your battery is in ship mode, your bike will not power on when you press the power button on the Rad UI Remote.) To exit ship mode, press the battery button for at least three seconds.

You can also assess your battery's charge level via the Color Display on your handlebar. It's possible for your battery's indicator lights and your Color Display to report slightly different charge levels. That's okay. If you notice a significant difference, this may indicate a problem in the electrical system. Please see ["Troubleshooting" on page 39](#) for more information.

Safe operating temperatures

We recommend riding in temperatures between 5°F to 105°F (-15°C to 40°C). Colder or hotter temperatures increase risks to your health and can also cause harmful internal battery temperatures.

Riding in very hot temperatures: Know and respect your physical limits around exercising in hot temperatures, and consult your doctor if you have any concerns. To prevent damage to your battery, do not ride in temperatures above 105°F (40°C). If you choose to ride in extremely hot temperatures, use low levels of power assistance (low pedal assist levels, low use of throttle) to keep the battery as cool as possible. This may lower the risk of the battery automatically turning off to prevent use-caused heat damage.

DANGER: Do not ride in extremely hot temperatures. The more the ambient temperature exceeds 105°F (40°C), the greater your risk of exceeding a maximum internal battery temperature of 131°F (55°C). This can cause the battery to turn off as a safety precaution. Extreme heat may also cause critical failure of the battery up to or including an electrical fire. Factors that increase your risk for battery overheating include, but are not limited to, ambient temperatures above 105°F (40°C), direct sunlight for extended periods, high throttle usage, high PAS level, high payload, steeper inclines, and other environmental factors.

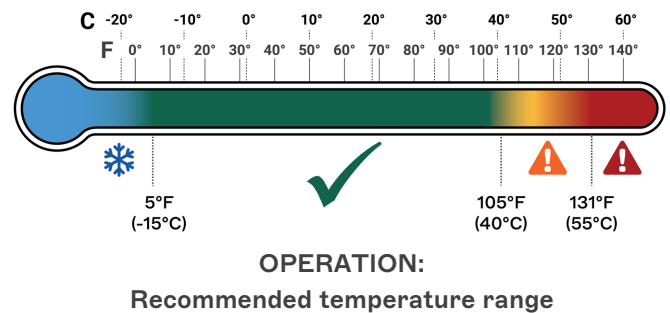



WARNING: Extreme cold of 5°F (-15°C) or below will reduce the range of your battery and can cause the battery to shut off automatically to prevent damage. Do not depend on battery power to return you back to safety if riding near those extreme temperatures. Riding in freezing temperatures can also expose your ebike to de-icing salt, which can harm your ebike and electrical components or cause an electrical fire. See [“Guard against rust, corrosion, and water damage” on page 39](#) for more information.

Removing and installing the battery

You can charge your battery either on or off your Radster Trail. If you remove it for charging, storage, transportation, security, or some other reason, keep these procedures to prevent battery damage.

BATTERY REMOVAL

To remove the battery, follow these steps.

1. **Place the key into the keyport and turn it to the unlocked position.**
2. **The battery lock will release the battery** from the frame and lift it out of the mount slightly.
3. **Carefully lift the battery up**, angling it away from and clearing the terminal contacts (“3” in the illustration).
4. **Pull the battery out of the mount.** Be careful not to drop or damage the battery when it’s loose from the bike. Do not touch or bend the terminal contacts.

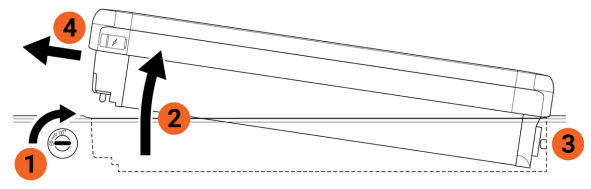

Removing the battery

NOTICE: When the battery is off its mount, protect the battery terminal contacts from damage or exposure to harmful substances including liquids and salt. Do not touch the terminal contacts. If the terminals become damaged, please discontinue use and contact Rad Power Bikes Product Support immediately.

BATTERY INSTALLATION/MOUNTING

To install the battery, you do not need the key. Check to ensure the battery mount is clean and dry, and then follow these steps.

1. **Gently insert the battery into the frame.**
2. **Align the battery with the terminal contacts.**
3. **Push down on the battery until you hear a click.** Do not force the battery into the battery mount. Ensure the battery is locked in place by gently pulling upward on it.

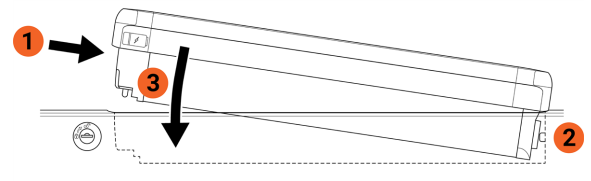

Installing the battery



CAUTION: An unlocked or improperly attached battery can fall off a moving ebike, causing damage or injury. Always check that the battery is properly attached and locked to the frame before moving or riding your ebike.

Before you charge

NOTICE: Failure to follow the battery charging best practices outlined in this manual could result in unnecessary wear to the battery and/or charger, and could lead to an underperforming or non-functional battery. Batteries damaged due to improper care will not be replaced under warranty.

Where to charge. Always charge in a safe, dry, indoor area that is away from children, direct sunlight, dirt, debris, tripping hazards (including electrical cords), or any materials that could ignite in the unlikely event of a charger or battery malfunction. Arrange the bike, battery, and charger to eliminate the potential for falls or other impacts. Make sure you stay close enough to it to check on it occasionally.

Turn the power off. Your bike must be turned off while the battery is charging.

Check the condition of your battery and charger. Make sure the battery, charger, and electrical cables show no signs of damage. The terminals on the battery and its mount must be free of dirt, rust, corrosion, and leakage.

WARNING: When charging any powerful battery, locate it somewhere you can get to it easily (or maneuver past it to safety) should there be a fire. Do not place it in a hallway or near a door such that it could block your exit in an emergency.

WARNING: Letting a battery charge unattended increases the risk that a charging problem will go undetected and lead to component damage or a fire hazard. Always charge your battery where you can monitor it.

Ensure the ambient temperature is appropriate. For best charging performance and to minimize wear and tear on components, we recommend charging at ambient temperatures of 41°F to 77°F (5°C to 25°C). Your battery generates heat while charging, but it's designed to air-cool, so keep it uncovered with the light facing upward on a flat, stable, hard, unheated surface. At relatively low temperatures, charging can take longer.

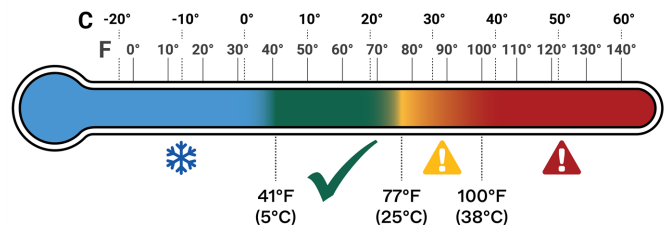

CHARGING:
Recommended temperature range

CAUTION: Do not charge your battery when it is warm from riding or in ambient temperatures above 100°F (38°C) to prevent unnecessary wear and tear on battery and charger. If the battery has turned off to prevent heat damage, wait until the battery cools down to turn the battery back on. Never charge your battery on or near heat-generating devices.

WARNING: Charging your battery with a charger other than one supplied by Rad Power Bikes and designed for your specific ebike model can cause damage to your ebike's electrical system or create a safety hazard. Only use a battery charger designed for your ebike and supplied by Rad Power Bikes.

WARNING: Using a damaged battery or charger can damage additional components or create a fire hazard. **Stop using your battery and charger and contact Rad Power Bikes immediately if any of the following occur:**

- Your charger's flexible power cord or output cable or any of the electrical cables on your ebike is frayed, has broken insulation, or any other signs of damage,
- Your battery or charger is physically damaged, non-functional, or performing abnormally,
- Your battery or charger experienced a significant impact from a fall, crash, or shipping damage, with or without obvious signs of damage,
- Your battery is leaking a clear, pungent, gel-like substance (which is potentially corrosive and flammable),
- Your battery will not fully charge (not all of the LEDs will light up) after the battery has been charging long enough so that it should be fully charged, i.e., it's been plugged in at least an hour longer than the time cited in ["Estimated charging times" on the next page](#) and/or the LED or LEDs on the charger indicate it has finished charging.
- Your battery was submerged in liquid or had extensive water exposure or damage, or
- Your charger becomes too hot to touch (it's designed to get warm with normal use), makes an unusual smell, makes a popping sound, or shows other signs of overheating.

Store any damaged or potentially damaged battery or charger in a safe, dry location away from the house and other flammable materials/structures and, as soon as possible, recycle or otherwise dispose of it according to local rules. Replacement batteries and chargers are available at radpowerbikes.com.

Charging procedure

To charge your battery, mind the advice in ["Before you charge" on the previous page](#) and then follow these steps.

1. **Turn the power off.** Press and hold the power button on the remote until the display turns off. If desired, use the key to unlock and remove the battery from the ebike frame. The battery can be charged either on or off the ebike.

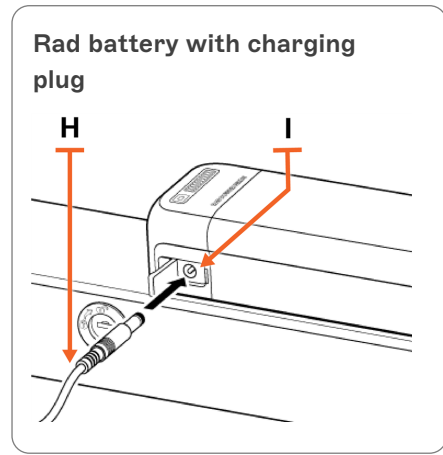
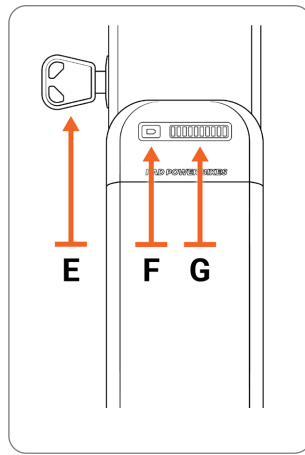
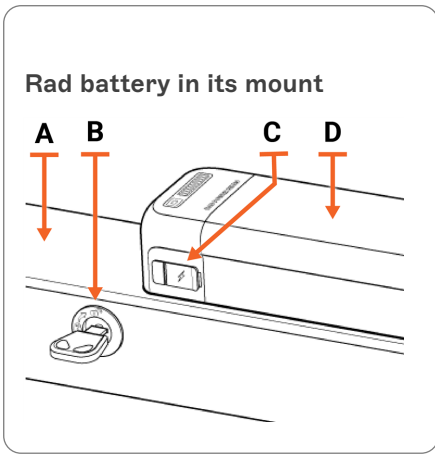

A	Bike frame
B	Keyport for locking and unlocking battery to frame (with key inserted)
C	Battery charging port with rubber cover in place
D	Battery
E	Key
F	Battery button (activates charge-level lights)
G	Charge-level lights
H	Charging plug
I	Battery charging port

2. **Locate the charging port of the battery.** The charging port is on the same side of the battery as the keyport. Note that the charging port includes a cover; the keyport does not have a cover.
3. **Place the charger on a flat, secure surface if you have removed it from your ebike.** The charging indicator light should face up.
4. **Plug the charger into the battery charging port.** Open the flexible cover on the charging port. Connect the charger's round barrel connector to the charging port on the side of the battery.
5. **Plug the charger into a power (wall) outlet.** Charging should initiate and will be indicated by the LED on the charger turning green (to indicate power source connection) and then immediately turn red to indicate active charging. When charging is complete, the LED will turn green again.
6. **When charging is complete, unplug the charger from the power (wall) outlet, and then unplug it from the battery.** Be sure to pull gently on the plugs, not on the cables themselves.

NOTICE: The charger is designed to stop charging automatically when the battery is full. Store the charger carefully, making sure its plug does not come in contact with liquids, dirt, debris, or metal objects, which can damage the plug and interfere with future operation.

Estimated charging times

The time needed to fully charge your battery depends on its age, how far it was used to travel, the nature of that travel (terrain, payload, PAS and throttle use, etc.), and other factors. The table here provides a rough estimate of charge time based on percentage of battery used. Charging at low temperatures can increase recharge time.

NOTICE: The battery may take longer to charge when fully depleted, when very new, and after 3–5 years of regular use. If your battery doesn't seem to be charging normally, is taking longer to charge than expected, or you're experiencing substantial reduction in range, discontinue use and contact Rad Power Bikes Product Support.

Capacity used	Recharge time
10%	.75 hour
20%	1.5 hours
30%	2.25 hours
40%	3 hours
50%	3.75 hours
60%	4.5 hours
70%	5.25 hours
80%	6 hours
90%	6.75 hours
100%	7.5 hours

Estimated range per full charge

We suggest that you select a lower PAS level when you're getting to know your Radster Trail and travel routes. Once you become familiar with your range requirements and the capabilities of your ebike, you can adjust your riding characteristics.

The table in this section provides range estimates to help you understand the factors that can increase or decrease range. Rad Power Bikes makes no claims about the range that individual users might experience in a particular situation.

25 mi (40 km):	<ul style="list-style-type: none"> Hilly terrain Windy 	<ul style="list-style-type: none"> Light pedaling Heavy payload 	<ul style="list-style-type: none"> PAS level 5, high throttle use
35 mi (56 km):	<ul style="list-style-type: none"> Flat terrain Not windy 	<ul style="list-style-type: none"> Moderate pedaling Normal payload 	<ul style="list-style-type: none"> PAS level 3, minimal throttle use
55-65 mi (88-104 km):	<ul style="list-style-type: none"> Flat terrain Not windy 	<ul style="list-style-type: none"> Moderate to heavy pedaling Normal payload 	<ul style="list-style-type: none"> PAS level 1, no throttle use

Best practices for extending range and battery life

Follow the best practices listed below to help extend your range and battery life.

- Whenever possible, avoid applying full throttle when the Radster Trail has slowed to very low speeds, has stalled, or stopped.
- Pedal to assist the motor when climbing hills and accelerating from a stop.
- Do not climb hills steeper than 15% in grade.
- Avoid sudden starts and stops.
- Accelerate slowly.
- Avoid riding in extremely cold or hot temperatures.

Battery storage

When storing your ebike from Rad Power between rides, follow the recommendations below to maintain the health and longevity of your battery.

SHORT-TERM STORAGE TEMPERATURES

Store the battery in a dry, indoor location between 14°F to 77°F (-10°C to 25°C).

DANGER: Storing your battery above 131°F (55°C), such as in a hot car in direct sunlight, can cause permanent range decline or critical failure, and could lead to electrical fire, serious injury, or death.

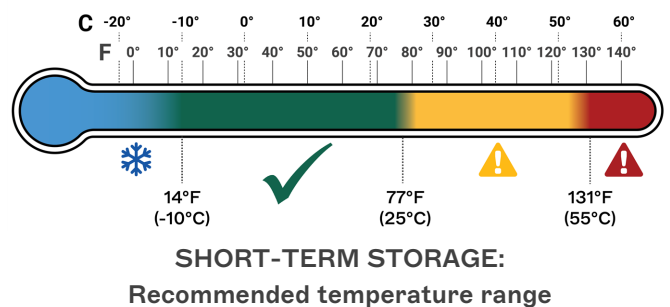

LONG-TERM STORAGE TEMPERATURES

For long-term storage (more than two weeks), choose a dry, indoor location. The ideal minimum temperature for long-term storage is a bit warmer than what's allowable for short-term storage. Make sure your battery stays between 40°F to 77°F (5°C to 25°C).

LONG-TERM STORAGE TIPS

- We recommend putting your battery in "ship" mode by pressing and holding the battery button for 3 seconds. This mode prevents the battery from releasing power to the electrical system, including any attached accessories. This can help extend its charge. To take your battery out of ship mode, press and hold the button again for 3 seconds.

- For long-term storage, we recommend that you keep your battery at approximately 40-70% charged. Check the battery's charge level monthly. If necessary, use the charger from Rad Power Bikes to charge the battery to about 40-70% charged.



CAUTION: Long-term storage of your battery at temperatures above 95°F (35°C) or below 40°F (5°C) can reduce battery performance and lifespan.



CAUTION: Don't store your battery long-term at full charge, zero charge, or very little charge. Storing your battery for long periods at *full charge* can cause range decline over time. Storing your battery for long periods at *very little or no charge* can cause permanent range decline or a non-functional battery.

Summary: Battery recommended temperatures

The temperatures listed below represent *ambient* temperatures. Internal battery temperatures are likely to be higher than ambient temperature during charging and use. The battery will automatically turn off to prevent damage when its internal temperature reaches below 5°F (-15°C) or above 131°F (55°C). Please see the preceding sections for more information.

Recommended operation (riding) range: 5°F to 105°F (-15°C to 40°C)

Recommended charging range: 41°F to 77°F (5°C to 25°C)

Recommended short-term storage range: 14°F to 77°F (-10°C to 25°C)

Recommended long-term storage range: 40°F to 77°F (5°C to 25°C)

Additional critical battery safety information

You must read and understand all safety-related messages in this section before handling, using, charging, or storing the battery that came with your Radster Trail.



DANGER: Never open the battery housing, which can expose you to caustic substances and electrical shock. It can also create a fire hazard, which can lead to serious injury or death. Opening the battery housing may void the warranty.



WARNING: Never immerse or submerge the battery in water or liquid, including water in the battery mount, which can cause damage, serious injury, or death. If the battery was immersed or submerged in water or another liquid, do not use the battery.



WARNING: Always remove the key from the keyport of the battery before riding. Do NOT operate the ebike with the key in the keyport, or injury to your leg or damage to the electrical system can occur.



CAUTION: Avoid salt water and de-icing compounds, which are very corrosive and can lead to damage, especially if they come in contact with the battery and its mount. Never ride through standing salt water, e.g., through waves at a beach.



CAUTION: Using aftermarket battery accessories or products that have not been tested by Rad Power Bikes for safety and compatibility may void your warranty, result in ebike or property damage, create a safety hazard, or cause injury. If you use products not tested and recommended by Rad Power Bikes, you do so at your own risk.



CAUTION: To reduce the risk of fire, connect only to a circuit provided with 10 amperes maximum branch circuit overcurrent protection in accordance with the National Electrical Code, ANSI/NFPA 70.

NOTICE: When the battery has no charge left, the ebike's electrical system will automatically shut down. Do not attempt to power the ebike's electrical system back on until you've recharged the battery.

NOTICE: Do not charge a USB device when the battery has very low or no charge left, as this can deplete the battery even further. Disconnect the USB device and charge the battery before attempting to charge the USB device again.

NOTICE: When the battery is off its mount, protect the battery terminal contacts from damage or exposure to harmful substances including liquids and salt. Do not touch the terminal contacts. If the terminals become damaged, please discontinue use and contact Rad Power Bikes Product Support immediately.

NOTICE: Always follow any safety information attached to the battery or charger. A sample label for the battery that shipped with your ebike is shown at right, manufacturing location and other details may differ. Do not remove this label from the battery.

Nominal Voltage: Rated 47.19V, Max 48V,
Capacity (Nominal): Rated 14.4 Ah, Max 15 Ah

Model: RAD-S15P 13INR22/71-3
RATING: 47.19V 14.4 Ah 679.5 Wh
Manufacturer: PYTES, MADE IN CHINA
Patent Pending. Designed in Seattle
by RAD POWER BIKES™

ATTENTION ⚠

- The battery pack **MUST** be locked into the frame battery mount before use.
- Ensure the battery and charger are not damaged before charging.
- Don't connect the positive and negative terminals of the battery pack.
- Don't expose the battery to high temperatures.
- Ensure the battery charger is unplugged from the battery pack and put away before you ride.
- Always charge your battery in temperatures between 10 and 25 degrees Celsius (50 and 77 degrees Fahrenheit).
- Do not subject the battery to salt water or leave the bike for extended periods in the rain.
- Only use original equipment for charging.

Icons: Recycle, No Open Flame, No Smoking, UL US LISTED LITHIUM ION LEV BATTERY, Recycle, Li-ion

Operating instructions

WARNING: Incorrect assembly, maintenance, or use of your ebike can cause component or performance failure, loss of control, serious injury, or death. Ebikes have parts that non-motorized bikes do not have, and neither the assembly video, assembly steps, or the rest of the manual cover all potential aspects of ebike configuration, maintenance, and repair, which can require specialized tools and skills. We strongly recommend you consult a professional, reputable bike mechanic to assist in the assembly, repair, and maintenance of your ebike, or inspect your work if you choose to do it yourself.

How the electrical system works

Your Radster Trail is equipped with two ways for a rider to use power assistance from the motor forward: a pedal assist system (PAS) and a twist throttle.

WARNING: Practice using the pedal assist (PAS) and throttle in a flat, clear, open area until you understand how these power sources work together. Failure to understand how to safely operate the PAS and throttle together can result in loss of control, crash, injury, and/or death.

HOW PEDAL ASSIST WORKS

You can use the pedal assist system (PAS) to call up assistance from the motor *while you are pedaling*.

Pedal assist uses a torque sensor built into the drivetrain of the ebike. The torque sensor detects how hard the rider pedals and signals the electric motor to provide a corresponding level of pedal assist (so the harder you pedal, the more pedal assistance you get).

HOW THE THROTTLE WORKS

The throttle is located on the right side of the handlebar. Twist it to propel the ebike forward. The more you twist, the more powerfully the motor will propel you. Once you release the throttle or apply the hand brake, the throttle power will stop.

NOTICE: Throttle and motor use may not be allowed in all areas. It is your responsibility to know and follow local ebike regulations, rules, and traffic laws where you ride.

Handlebar features

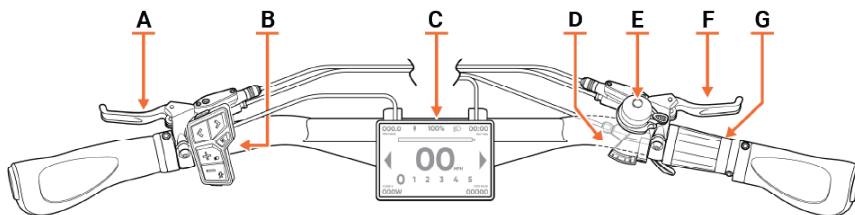

A	Left brake lever (front brake)
B	Remote
C	Color Display
D	Shifter
E	Bell
F	Right brake lever (rear brake)
G	Throttle

Color display functions and electrical controls

Using the Remote, the Color Display and other ebike features, you can power your ebike on or off, change pedal assist levels, and control other electrical functions.

REMOTE

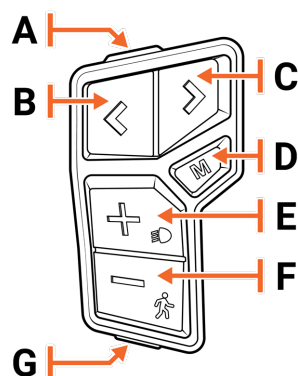

A	Power button
B	Left turn signal button
C	Right turn signal button
D	Menu (M) button
E	PAS level up/Headlight button
F	PAS level down/Walk button
G	USB Port

COLOR DISPLAY

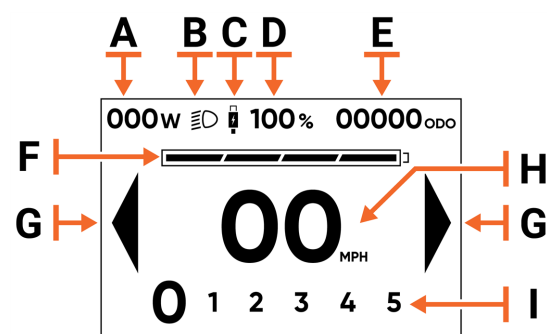

A	Wattage level
B	Headlight icon
C	USB charging indicator
D	Remaining battery percentage/remaining range estimate
E	Odometer
F	Battery level indicator
G	Turn signal indicators
H	Speedometer
I	Pedal assist system (PAS) level

Power	Power on/power off	Press and hold the Power button until the display illuminates.
	Power save timer	The Color Display will power off automatically after 5 minutes of inactivity, unless a USB device is charging, in which case the device will continue to charge in lower power mode for up to 3 hours.
Lights	Lights at startup	Headlight, taillight, and display backlight will turn on automatically when the ebike is powered on.
	Turn on headlight/taillight	When the ebike is powered on and the headlight is off, press and hold the Up/Headlight button.
	Turn off headlight/taillight	To turn off the headlight for daytime riding (which is optional), press and hold the Up/Headlight button.
	Brake light	See “Brake light” on page 27
Pedal assist system (PAS)	Increase pedal assist one level	Press the Up button on the remote.
	Decrease pedal assist one level	Press the Down button on the remote.
Turn signals	Signal a turn	Before you begin a turn, press the left or right turn signal button to activate the turn signal on the taillight.
	Turn off turn signal	Once you have completed a turn, press the left or right turn signal button to deactivate the turn signal on the taillight.



WARNING: Do not substitute turn signals instead of using hand signals when riding your ebike. Always follow local guidelines requiring the use of hand signals when riding, and never assume that other vehicles on the road can see the turn signals while riding.

Walk mode	Turn on walk mode	Press and hold the Down button on the remote. After approximately three seconds walk mode will power on and propel the ebike forward at 3 mph (4.8 km/h). This is helpful for walking up a hill with heavy cargo, for example.
	Turn off walk mode	Walk mode will stay on while the Down button is being held. Release the Down button to exit walk mode and end motor assistance, or squeeze a brake lever to cut off motor assistance.
	How walk mode is displayed	The walk mode animation () will display in the center of the Color Display.



CAUTION: Using walk mode inappropriately can cause you to lose control of the ebike, causing ebike damage or injury. Use walk mode only while dismounted from the ebike, with both hands on the handlebar, and with at least one hand on a brake lever so that you can quickly cut off power to the motor if necessary.

Battery charge level	Battery level indicators on the Color Display	The remaining battery percentage/remaining range estimate will be located at the top of the display, and the larger battery state of charge level indicators will be located above the speedometer.
	Battery level indicators on the battery	On the battery, 10 light bars (see page “Battery information” on page 17).
Wattage, USB charging and speedometer	Speedometer	Current bike speed displayed in either miles per hour (MPH) or kilometers per hour (KM/H).
	USB charging status	When a USB-enabled device is plugged into the USB charging port the display will show an icon indicating the device is being charged.
	Wattage meter	Power in watts the bike is using in real time.
Additional display options	The following additional display options are accessible by pressing the Menu (M) button to toggle between ride screens. To return to the main screen, press the Menu (M) button again.	
	Trip time	The trip time is the total elapsed time over a ride (or rides).
	Trip distance	The trip distance is the total distance traveled during a ride (or rides).
	Class level	The selected class level will display in this field.

COLOR DISPLAY PROGRAMMING

You can use the buttons on the remote to change system settings while the bike is stopped. The pedal assist and throttle functionality will be disabled while in the menu screens.

- Enter Menu screen.** Press and hold the Menu button on the remote to enter the Menu screen.
 - Menu options.** Press the Up or Down buttons to move through the menu options, and then press the Menu button to make changes to each setting:
 - Trip:** Reset both trip time and trip distance data.
 - Class:** Switch between motor class settings. Once a new class is selected, it will default the next time the ebike is turned on.
 - Class 1 = 20 MPH (32 KM/H) max speed, throttle limited
 - Class 2 = 20 MPH (32 KM/H) max speed, throttle enabled
 - Class 3 Limited = 25 MPH (40 KM/H) max speed, throttle enabled (US ebikes only)
 - Class 3 = 28 MPH (45 KM/H) max speed, throttle enabled (US ebikes only)
- NOTICE:** Maximum speed and throttle usage may not be allowed in all areas. Always follow local regulations when selecting a motor class setting for your ebike.
- Units:** Switch between displaying Kilometers per Hour (KM/H) or Miles per Hour (MPH) on the ride screen.
 - Range:** Switch between displaying remaining battery range and remaining mileage range on the ride screen.
 - Brightness:** Adjust display brightness setting.

- **Security:** Enable the optional security feature to require a passcode or NFC card to unlock the ebike at startup.
- **Passcode:** Enter a four-digit numerical passcode required to unlock the ebike at startup. You will need to use this same passcode if you want to change it in the future.
- **NFC:** Set up the provided NFC (near field communication) cards to unlock the ebike at startup when security is enabled. Navigate to one of the empty NFC tags on the display and press the Menu (M) button to select. Hold an NFC card over the display to detect it, and then press the Menu button to bind the tag to the card.

NOTICE: If you have forgotten your passcode and/or lost your NFC cards and cannot unlock your ebike, you can bring it to a Rad Power Bikes service center for assistance unlocking it. But Rad Power Bikes will not be able to unlock your ebike remotely, so keep a record of your passcode somewhere safe.

- **Information:** Display and Motor Controller specifications. This information is for reference only, and cannot be changed.
3. **Exit programming mode.** When you're done changing settings, exit the menu by pressing and holding the Menu (M) button.

Brake light

The Radster Trail is equipped with a taillight/brake light that is integrated into the electrical system. When you turn on your ebike, both the headlight and taillight will illuminate to make you more visible to other vehicles. Any time the ebike is powered on, squeezing one or both brake levers on the handlebar will activate the brake light, causing the taillight to illuminate additional areas.

The taillight also includes integrated turn signals to help improve your visibility in low light conditions. Press the turn signal buttons on the remote to activate the turn signal before starting a turn, and press again when the turn is completed to turn off the turn light.



WARNING: Do not substitute turn signals instead of using hand signals when riding your ebike. Always follow local guidelines requiring the use of hand signals when riding, and never assume that other vehicles on the road can see the turn signals while riding.

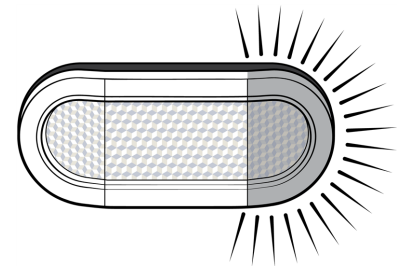

Start-up procedure

Before you can take your first ride you need to have properly assembled your ebike, tightened all components correctly, read this entire manual, and had a professional, reputable bike mechanic check the assembly. You also need to be at least 16 years old, and don't forget to put on a helmet.

Follow these steps to ride Rad!

1. **Check that the battery is locked securely.**



CAUTION: Getting onto the ebike or riding it with the key in the battery can cause injury to your leg and damage to the key or lock mechanism. Always remove the key before riding the ebike.

2. **Turn on the ebike.** Press the Power button on the remote until the color display indicates the system is starting up.
3. **Try out your bell** if you haven't already! It's an important safety tool for alerting others to your presence, especially when passing. To ring it, flick the bell lever; see the illustration "[Handlebar features](#)" on page 24.
4. **Select your desired level of pedal assistance (PAS)** from 0 through 5 using the up and down arrows on the remote. Level 0 provides no pedal assistance, level 1 provides the lowest amount of pedal assistance, and level 5 provides the highest amount. Start in PAS level 0 or 1 and increase PAS levels one at a time as you get comfortable.



5. **Begin riding carefully.** With the proper safety gear and rider knowledge, you may now operate your ebike. Start pedaling on flat ground, clear of obstacles and people, with the ebike in an easy (low) gear and at pedal assist level 0 or 1. You may also use the throttle to accelerate and maintain your desired speed.

NOTICE: While you're getting to know your ebike, don't ride with passengers or cargo (see ["Carrying cargo or a child" on the next page](#) for more information). Review, understand, and follow the safety information in ["Ride as safely as possible" on page 42](#).

6. **Use the throttle** (next to the right handlebar grip) by slowly and carefully rotating it toward the rider. Do not use the throttle unless you're on the bike, and note that the throttle can be activated with a twist any time the bike is powered on.

 **WARNING:** Be careful not to accidentally twist the throttle, which can cause sudden acceleration. If you're not prepared for this acceleration, you can lose control of the ebike, which can lead to serious injury or death. To minimize this risk, always keep at least one hand ready to squeeze the brake lever to cut off power to the motor. When you dismount, power off the bike before moving it.

 **WARNING:** Engaging the pedal assist feature, especially at a high setting, will cause acceleration that may be greater than expected, especially for relatively new riders, and that can cause loss of control, serious injury, or death. To minimize risk, start at PAS level 0 or 1.

Moving and storage instructions

Please follow these tips to ensure your ebike is well cared for when you're not using it.

PARKING AND STORAGE

- Park in accordance with local rules and regulations, especially if you're in a public place.
- Park indoors whenever possible. If you must park outdoors in rain or wet conditions, do not do so for an extended period of time, and afterward park in a dry location to allow the ebike systems to dry out. When any bike or ebike is exposed to wet conditions, it will need more frequent maintenance to prevent rust and corrosion and to ensure all systems work safely. See ["Guard against rust, corrosion, and water damage" on page 39](#).
- Avoid parking or storing your ebike in direct sunlight, which can cause damage to electrical components.
- Do not park or store your ebike in excessive heat, such as inside of a parked car on a hot day. Always store your ebike within this temperature range: 14°F to 77°F (-10°C to 25°C).

 **DANGER:** Storing your battery above 131°F (55°C), such as in a hot car in direct sunlight, can cause permanent range decline or critical failure, and could lead to electrical fire, serious injury, or death.

- Register your ebike with [BikeIndex](#), [529 Garage](#), or a regional bike registry (ask your local bike shop for recommendations) to increase the chance you'll get your ebike back in the unfortunate event it's stolen.
- Lock up your ebike to reduce risk of theft. You can purchase a lock from our website at [radpowerbikes.com](#) or consult a local bike shop.

TRANSPORTING

- When pushing or carrying the ebike, turn off the power to avoid accidental acceleration from the motor, e.g. by mistakenly twisting the throttle.
- Do not leave a battery in direct sunlight or any location that is or may become excessively hot or cold, like a parked car, for extended periods.
- Before using public transportation (buses, trains, etc.) to transport your ebike, check with the relevant transportation authority for rules that might apply to ebikes, including weight and size limits, tire widths, lithium-ion batteries, etc.
- Avoid transporting any electrical bike on a vehicle rack or truck bed during rain, which may cause water damage to the electrical components. See ["Guard against rust, corrosion, and water damage" on page 39](#) for more information. In any weather, it's safest to remove your battery before transporting your ebike. Carry the battery inside the vehicle, carefully placed to protect it from impacts, dirt, liquids, or other hazards.

Carrying cargo or a child

Carrying cargo or a child can help you have more fun on your ebike and replace trips you'd otherwise make with a car, which we think is rad. It also involves additional risks. You must read and understand this entire chapter and the rest of the manual plus any documentation that comes with any accessories you purchase before you ride your ebike with cargo or a child.



WARNING: Cargo can only be safely carried on a rear rack, front-mounted rack, or basket. Do not modify the rear rack to accommodate third-party cargo accessories, as this will void your warranty and may result in accidents, property damage, injury or death.



WARNING: Do not attach a trailer to the rear rack, as this may create unsafe riding conditions leading to accidents, property damage, injury or death.



WARNING: The maximum recommended tire size for your Radster Trail is 27.5" x 3". Tires that exceed this diameter and width may not be compatible with your wheels, and may create unsafe riding conditions leading to accidents, property damage, injury or death.

Your Radster Trail is designed to carry a single small child in the optional Thule Yepp Maxi child seat attached to the rear rack. See "[Carrying passengers](#)" on the next page for more information.

For more information on optional accessories for your ebike, please go to radpowerbikes.com.

NOTICE: Carrying a passenger, child, or cargo may not be allowed in all areas. It is your responsibility to know and follow all applicable laws where you ride your ebike.

Weight limits

The total maximum payload of your Radster Trail, listed below, includes the weight of the rider plus any passenger(s), cargo, accessories, etc. Rad Power Bikes accessory capacity limits are available with the installation instructions that come with the accessory, or online at radpowerbikes.com/collections/accessories.

Total maximum payload of the Radster Trail : 370 lb (167 kg)

Maximum rider weight: 290 lb (132 kg)

Rear rack maximum payload: 55 lb (25 kg)



WARNING: Never exceed the payload limit of any accessory or component of your ebike even if you attach to it an accessory that carries a higher weight limit. Overloading any component can cause component failure, loss of control, serious injury, or death.



WARNING: Failure to ensure that cargo can't interfere with the operator's control of the ebike can lead to serious injury or death. The operator is always responsible for securing loads, loose straps, and gear.

Carrying loads (cargo or passengers) safely

Follow these instructions to maximize safety when using your Radster Trail to carry cargo or a passenger.

LOAD AND SECURE CARGO CAREFULLY

- Hold onto the ebike when loading and carrying cargo and/or passengers. The kickstand is not designed to be used for loading cargo or passengers. Do not assume the bike is stable and balanced when using the kickstand.
- Load cargo as low as possible and evenly on both sides of the rack to keep the ebike's center of gravity low and improve stability.
- Ensure cargo loads are properly secured and periodically check that nothing loosens, risks interfering with any moving parts, or risks touching or dragging on the ground.
- Ensure cargo loads do not obscure the headlight, taillight or reflectors when riding.



WARNING: Failure to ensure that cargo or a passenger can't interfere with the rider's control of the ebike can lead to serious injury or death. The rider is always responsible for securing loads, loose straps, and assessing a passenger's ability to ride safely. Please see ["Carrying passengers" below](#) for more information.



WARNING: Loading cargo or a passenger without holding onto the Radster Trail can cause it to tip, leading to damage or serious injury. The kickstand is designed to hold up an unoccupied, unloaded ebike on a hard, flat, level surface, not to support the weight of the rider, passengers, or cargo. Always hold onto your Radster Trail when loading or unloading cargo or passengers.

PRACTICE WITH LIGHT LOADS IN A SAFE AREA

Carrying extra weight significantly affects braking, acceleration, turning, balancing, etc. These effects can be increased by challenging riding conditions, such as when roads are wet or slick. Hills that are normally easy to climb or descend without cargo can become challenging or even dangerous once extra weight is loaded onto the ebike.

Extra weight will also increase the time it takes to slow the ebike when braking.



WARNING: Carrying cargo or passengers significantly affects braking, acceleration, turning, and balancing, which can increase the risk of falls and other accidents, potentially leading to property damage, serious injury, or death. To minimize such risk, practice riding with light cargo in a flat, open area before attempting to carry heavier cargo or passengers, especially on roads or hills and in wet conditions.

USE BOTH BRAKES

With extra weight on your ebike, it's more important than ever to use both front and rear brakes, and always engage the rear brake first to prevent excessive strain on the front wheel and fork and to prevent loss of control. Ensure both front and rear brakes are properly adjusted, maintained, and applied.



WARNING: Using the front brake by itself can cause excessive stress on components, damage to the ebike and parts, loss of control, injury, or death. Always apply the rear brake before applying the front brake, using both brakes for all operations.

ADJUST YOUR ROUTES AND SPEED

When carrying heavy loads or passengers, plan your routes to avoid challenging hills and other hazards. Ride more slowly, and leave more time and distance for braking.

Carrying passengers

Your Radster Trail is designed to carry one small child in a Thule Yepp Maxi child seat.



DANGER: Using your Radster Trail to transport a passenger who is not the appropriate size or age for your child seat, or who does not have the health, motor control, or impulse control to ride safely as a passenger, can lead to serious injury or death of the operator and/or passenger. Read and understand the specifications of any child seat you purchase and all safety, cargo, and passenger-related information in this manual. It is your responsibility to assess the ability of a potential passenger to ride safely. If you're not certain, consult a physician.



DANGER: Leaving a child unattended on a bicycle creates a VERY HIGH RISK of the bike tipping over, causing serious injury or death. Always remove your child from the bike before you look away or walk away from the bike.



WARNING: To reduce the risk of injury, always closely supervise children if and when you use your Radster Trail near them.



WARNING: Serious injury or death can occur if clothing or body parts contact either wheel or other moving parts while the bike is in motion.

USING A CHILD SEAT FOR SMALL CHILDREN

The Thule Yepp Maxi child seat can be purchased from Rad Power Bikes at radpowerbikes.com.

For installation instructions, safety notices, age/weight requirements, general information, and tips on safe operation of the Thule Yepp Maxi child seat accessory, visit the manufacturer's website online at www.thule.com or visit the Rad Power Bikes Help Center at radpowerbikes.com/help.

Carrying pets

Rad Power Bikes understands that you may want to bring your pet along on your ebike adventures, and we think that's rad. We urge you to take great care to protect your furry friend and yourself. To check out the pet accessories that we have tested for safety and compatibility with our ebikes, please visit radpowerbikes.com. We cannot recommend any pet carrier or restraint system that we have not tested for compatibility and safety with your ebike from Rad Power Bikes.



WARNING: Transporting a pet using any bike or ebike puts you and your pet at risk of injury or death, especially if the pet distracts you, affects your balance, interferes with moving ebike parts, or causes you to exceed your ebike's or a component's maximum weight capacity, etc. It's impossible to anticipate every situation that can occur while riding with a pet. If you carry a pet on any bike, ebike, or similar vehicle, you assume any and all inherent risks.



WARNING: The ebike operator is always responsible for assessing a pet's ability to ride safely. Using this product to transport a pet that does not have the health and temperament to ride safely can lead to serious injury or death of the operator and/or pet(s). Consult a veterinarian or pet behavior specialist if you have any questions or concerns.



WARNING: Never leave a pet unattended in a pet basket carrier or other appropriate pet accessory on the ebike. Leaving pets unattended on the ebike creates a VERY HIGH RISK of the pet trying to escape or the ebike tipping over, leading to damage, serious injury, or death.

Safety checklists



WARNING: Ebike components like brakes, cables and tires may wear out faster than would be the case for non-motorized bicycles, requiring more service. **You must check your ebike before each ride** and according to the other checklists in this manual, and have a professional, reputable bike mechanic perform a thorough tune-up following the service intervals described here, or sooner if you discover increased wear. Failure to do so could result in property damage, serious injury, or death.



PRE-RIDE CHECK
rad-go.com/safety

IMPORTANT SAFETY INSTRUCTIONS

When using this product, basic precautions must always be followed, including the following:

- Read all the instructions in this manual before operating the ebike.
- Do not put fingers or hands inside any ebike components during operation.
- To reduce the risk of injury, close supervision is necessary when using the ebike near children.
- For safe operating temperatures, battery charging temperatures and storage temperatures, refer to the values listed in [“Safe operating temperatures” on page 17](#).

RISK OF FIRE, ELECTRIC SHOCK OR INJURY

Like any electric vehicle, your ebike can involve risk of fire, electric shock or injury in the course of normal operation. Follow these guidelines to minimize risk:

- Familiarize yourself with safe battery operation, charging and storage guidelines as described in [“Battery information” on page 17](#) to minimize the risk of electric shock and fires.
- Follow the safety checklists in this section to ensure your ebike is in good mechanical shape and safe to ride.
- If you discover any damage to the battery, charger, cable connections or any other components on your ebike during a safety check, discontinue use immediately and contact Rad Power Bikes Product Support, or take your ebike to a local, professional, reputable bike mechanic for assistance.

BEFORE YOUR FIRST RIDE

- Make sure handlebar cables were routed correctly when the handlebar was installed. Turn the handlebar fully to the left and right and make sure this doesn't pull any of the cables or wires taut.
- Make sure your pedals are secured using a pedal wrench or a torque wrench fitted with a crowfoot bit. Torque according to the values listed in [“Tools and torque specifications” on page 11](#).
- Check that the cable connectors on the ebike are all plugged in securely and that nothing loosened in shipping.
- Check the brake functions per [“Checking brakes and motor cutoff switches” on page 36](#), but note that brakes can rub a little the first few times you ride. This is okay and normal; any squeak or noise should go away with use.
- Check everything on the “Before every ride” list below.

BEFORE EVERY RIDE

Before every ride, follow the safety checklist in the table below. If you find anything amiss with your ebike, don't ride it until you're sure it's fixed. Consult a local, professional, reputable bike mechanic or explore our Help Center at radpowerbikes.com/help if you have any questions.

Fasteners

- Ensure all fasteners are correctly tightened according to [“Tools and torque specifications” on page 11](#).
- Check that the fasteners on any accessories you've added are properly tightened according to the manufacturer's instructions.

Brake system



WARNING: Ebike disc brakes may wear out faster than would be the case for non-motorized bicycles, requiring more service. Make sure to inspect brake components before every ride, and follow the maintenance intervals listed in [“Recommended service intervals” on page 35](#).

- Check brake pads and ensure the brake pad material isn't thinner than the backing plate it attaches to.
- Ensure brake pads are correctly positioned in relation to the brake rotors.
- Ensure brake hose shows no obvious wear.
- Ensure brake levers are properly positioned and tightly secured to the handlebar.
- Ensure the brake lever feel is appropriate.
- Check that the taillight brightens when you squeeze each brake lever.
- Use the techniques in [“Checking brakes and motor cutoff switches” on page 36](#) to test the brake levers, brakes, and motor cutoff switches.

Drivetrain: cranks, pedals, chain, derailleur, shifter

- Ensure pedals are securely tightened to the cranks, that cranks are not bent, and that cranks are securely tightened to the bottom bracket. See [“Tools and torque specifications” on page 11](#).
- Ensure the chain is clean, lubricated, and runs smoothly. Take extra care with chain maintenance if the ebike is used in wet, salty, dusty, or otherwise damaging conditions.
- Check that the derailleur is adjusted and functioning properly.
- Ensure the shifter is attached to the handlebar securely and is shifting properly.

Motor drive assembly & throttle

- Ensure the hub motor is spinning smoothly and is in good working order.
- Ensure the power cable running to the hub motor is secured and undamaged.
- Check the axle nuts to ensure they are correctly tightened (see [“Tools and torque specifications” on page 11](#)).
- Ensure the torque washers, torque arm, and torque arm bolt are in place and secured.
- Ensure the throttle and pedal assistance are operating normally.

Steering

- Ensure the handlebar and stem are correctly aligned, adjusted, and tightened for proper steering.
- Perform the tests in [“Handlebar twist and push tests” on page 38](#).
- Ensure the handlebar grips are secure and undamaged.

Bearings

- Check that headset, wheel, pedal, and bottom-bracket bearings are lubricated, run freely, and display no excess movement, grinding, or rattling.

Wheels and tires



WARNING: An improperly secured front or rear wheel can cause loss of control, accidents, serious injury, or death. Check that the wheels are properly secured during assembly and before each ride.

- Ensure tires are holding air and inflated to within the PSI limits displayed on the tire sidewalls.
- Ensure tires have good tread, have no bulges or excessive wear, no cracks, and are free from any other damage or foreign objects.
- Ensure rims run true and have no obvious wobbles, dents, or kinks. See [“Tire and wheel care” on page 37](#).
- Check each wheel spoke. If any are loose or broken, seek help from a professional, reputable mechanic.
- Check the security of all wheel mounting hardware (wheel axle nuts, quick-release levers). Check wheel security and hardware torque on a regular basis (see [“Tools and torque specifications” on page 11](#)). Wheels can become loose or unsecured with normal use.

Frame, fork, and seat

- Check that the frame and fork are not bent or broken.
- Check that the seat is adjusted properly, that the seatpost quick-release lever is securely tightened, and that the seat does not move when the lever is closed. Ensure that the seatpost minimum insertion marking is fully inserted into the frame.

Battery

- Ensure the battery is charged.
- Ensure there is no damage to the battery.
- Ensure the battery gauge on the and the charge status indicator on the battery read similarly.

Cables

- Look over electrical cable connectors to make sure they are fully seated and free from debris or moisture.
- Check cables and cable housing for signs of damage. Do not use the product if any power cables are frayed, have broken insulation or show signs of damage.
- Ensure cables are secured away from moving parts.
- Ensure headlight, taillight, and brake light are functioning, adjusted properly, and unobstructed.

Accessories & safety gear

- Ensure all reflectors are properly fitted and not obscured.
- Ensure all accessories and components installed on the ebike are properly secured and functioning according to their manufacturer's specifications.
- Check all safety gear, clothing, cargo, and accessories for loose or potentially loose elements and secure them.
- Ensure rider and any passengers are wearing a helmet and other required riding safety gear, and inspect these items for signs of damage.
- If your ebike has fenders: Ensure they are centered over the wheels, adjusted properly, properly secured (see [“Tools and torque specifications” on page 11](#)), and have no cracks or holes.



WARNING: Riding your ebike when any component's useful life is surpassed can cause that component to fail, resulting in loss of control, serious injury, or death. Pay attention to signs of wear such as cracks, scratches, component color change, and operational changes that could indicate a component needs replacing. Before each ride, check your ebike using the [“Safety checklists” on page 32](#). Perform regular maintenance according to [“Recommended service intervals” on the next page](#). If you're not sure you have the experience, skills, and tools to perform safety checks and regular maintenance, consult a professional, reputable bike mechanic for help.

AFTER EVERY RIDE

- Store your ebike and battery in a dry location and follow the advice in [“Moving and storage instructions” on page 28](#).
- Guard against damage from the elements. See [“Guard against rust, corrosion, and water damage” on page 39](#).
- Charge your battery in a dry, indoor location according to the directions in [“Battery information” on page 17](#).

User maintenance instructions

Follow these maintenance guidelines to ensure your Radster Trail stays safe and fun to ride.

Check and service your ebike regularly

On any bike or ebike, certain parts need to be replaced periodically due to wear, and sometimes parts become damaged for various reasons. Check your ebike before each ride by following the directions in [“Safety checklists” on page 32](#). Have your ebike regularly serviced by a professional, reputable bike mechanic. See [“Recommended service intervals” below](#) for more information.

Components of any electrical bike are subject to higher wear compared to the components of bikes without power assistance. This is because ebikes can travel at higher average speeds than regular bicycles and generally weigh more. Higher wear is not a defect in the product and is not subject to warranty. Typical components affected are the tires, brake pads and rotors, forks, spokes, wheels, and the battery.

If you need to replace a part on your ebike, visit radpowerbikes.com. If you want something that isn't listed there, contact Rad Power Bikes Product Support. Be extremely careful about using parts or accessories that Rad Power Bikes has not tested for safety and compatibility with your specific product.



WARNING: Using aftermarket accessories or components (trailers, stands, vehicle racks, etc.) that have not been tested by Rad Power Bikes for safety and compatibility with your specific ebike may void your warranty, create an unsafe riding condition, result in ebike/property damage, or cause serious injury or death. If you use replacement parts or accessories not tested and recommended by Rad Power Bikes, you do so at your own risk.

Recommended service intervals

Regular maintenance of any bike or ebike is key to ensuring the best possible performance and reducing wear and tear on systems. Ideal service intervals vary depending on use conditions. We generally recommend inspections, service, and necessary replacements be performed at the time and distance intervals described below, but have your ebike serviced more frequently if you ride aggressively, with heavy payloads, or in harsh conditions. Have your ebike inspected immediately if you notice problems or your ebike has been involved in a fall or other accident.



WARNING: Have your ebike inspected by a professional, reputable bike mechanic after any fall, crash, or accident, as these can cause damage (visible or internal/not readily apparent), make your ebike unsafe, and lead to serious injury or death. Be particularly cautious about using a battery that has experienced a significant impact from a fall or crash; a damaged battery may not show external signs of damage. Using a damaged battery or charger can create additional ebike damage or a fire hazard. For more information, see [“Battery information” on page 17](#).

AFTER BREAK-IN PERIOD OF 50–100 MILES (80–160 KM)

- Inspect** Check all cables for stretch.
- Check spoke tension and the trueness of the wheels.
- Check all bolted connections for loosening and ensure they are tightened to recommended torque values (see [“Tools and torque specifications” on page 11](#)).
- Service** Have a professional, reputable bike mechanic adjust cable tension and check torque



WARNING: Certain components can stretch or loosen during any bike or ebike's break-in period, which can lead to component failure and potential injury or death. Be sure to have a professional, reputable bike mechanic inspect your ebike and make any adjustments needed after this break-in period, or sooner if you notice any problems or if you ride aggressively, with heavy payloads, or in harsh conditions.

WEEKLY, 100–200 MILES (160–320 KM)

- Inspect** Check hardware for proper torque—see [“Tools and torque specifications” on page 11.](#)
- Check drivetrain for proper alignment and function (including chain, freewheel, chainring, and derailleur).
- Check wheel trueness and spoke tension, and check for quiet wheel operation (without spoke noise).
- Check frame for any damage.
- Service** Clean frame by wiping frame down with damp cloth.
- Clean and lubricate the chain. More information is available online at radpowerbikes.com/help.
- Replace** Replace any components confirmed to be broken or damaged beyond repair by Rad Power Bikes Product Support or a professional, reputable bike mechanic.

MONTHLY, 250–750 MILES (400–1200 KM)

- Inspect** Check brake pad wear, alignment, and the brake lever feel.
- Check for proper shifting and proper derailleur cable tension.
- Check chain stretch.
- Check shifter cables for corrosion and fraying.
- Check wheel trueness and spoke tension, and check for quiet wheel operation (without spoke noise).
- Service** Clean and lubricate drivetrain.
- Check crankset and pedal torque.
- Clean shifter cables.
- Tension spokes and true wheels if any loose spokes are found.
- Replace** Replace shifter cables if necessary.
- Replace brake pads if necessary (typically when the pad material is thinner than the backing plate).

EVERY 6 MONTHS, 750–1250 MILES (1200–2000 KM)

- Inspect** Inspect drivetrain (chain, chainring, freewheel, and derailleur).
- Inspect all cables and housings.
- Service** Basic tune-up by professional, reputable bike mechanic.
- Grease bottom bracket.
- Replace** Replace brake pads.
- Replace tires if necessary.
- Replace cables and housings if necessary.



WARNING: Ebike components like brakes, cables and tires may wear out faster than would be the case for non-motorized bicycles, requiring more service. Make sure to inspect components regularly, and have a professional, reputable bike mechanic perform a thorough tune-up following the service intervals described here, or sooner if you discover increased wear.

Checking brakes and motor cutoff switches

All vehicles, including your Radster Trail, need reliable brakes. Test your brake levers, brakes, and motor cutoff switches for proper functioning before every ride. If anything seems wrong, take your ebike to a local, professional, reputable bike mechanic, or refer to our Help Center (radpowerbikes.com/help).



WARNING: Touching the brake rotor, which has sharp edges and can get very hot while you're riding, can cause serious injury, slicing damage, or burns. The brake rotor heats up from normal friction when the brake pads press against the brake rotor to slow or stop the ebike. Touching the brake rotor with bare skin can also transfer natural oils to the rotor, and oils or other lubricants can decrease braking performance. **Do not touch the brake rotor, especially when it's in motion or after you've been riding your ebike.** Touch the brake rotor only for necessary maintenance when it is cool, not moving, and while you are wearing gloves or using other appropriate protective equipment.



Tire and wheel care

The tires and inner tubes that came with your ebike are designed for durability and safety for regular cycling activities. Wheels and tires need to be checked before each use to make sure they're in good condition. Always replace tires and inner tubes that have punctures, cuts, bulges, damage, or excessive wear before you ride.

TIRE INFLATION

Inflate tubes and tires to within the PSI (pounds per square inch) range stamped onto the tire sidewall. For additional information about tire pressure, please consult our Help Center at radpowerbikes.com/help.

NOTICE: Be sure not to confuse the PSI value on your tire sidewall with the "TPI" (threads per inch) value, which may also be listed there.



WARNING: Underinflating your tires can result in loss of control. Overinflating can make tires burst. Either scenario can lead to serious injury or death. Always maintain the correct air pressure of your tires, which is listed on the tire's sidewall, and use a regulated air source with pressure gauge so that you can measure pressure accurately.

WHEEL "TRUENESS"

Your wheels must always spin straight ("true") and must be repaired or replaced if they wobble side to side or up and down when spinning. To test them, do this:

1. Spin the wheel.
2. Brace a dull pencil against the frame or fork, with the tip just touching the rim.

If the gap between the spinning rim and pencil changes more than 5 mm, your wheels may need truing. If your wheels become untrue or if spokes loosen, which can happen with normal use, we recommend that you have a professional, reputable bike mechanic perform wheel tuning and truing operations. Do not attempt to true wheels or tighten spokes unless you have the highly specialized skills and tools to do so.

TIRE REPLACEMENT

Even tires equipped with built-in flat-preventative tire liners, like those that come with your Radster Trail, can and do get flats from punctures, pinches, impacts, and other causes. If you get a flat tire or see evidence of tire wear, you must replace your tire and/or tubes before operating the ebike again. Otherwise, you risk ebike damage, serious injury, or death.



CAUTION: Removing a tube from your wheel rim before the air has been released from it can cause the tube to burst, potentially causing serious injury. Always release air pressure before removing your tube.



WARNING: The maximum recommended tire size for your Radster Trail is 27.5" x 3". Tires that exceed this diameter and width may not be compatible with your wheels, and may create unsafe riding conditions leading to accidents, property damage, injury or death.



WARNING: Aftermarket tires or inner tubes not provided by Rad Power Bikes may not be compatible with your wheels or the performance requirements of your ebike. Such tires can fail or create unsafe riding conditions, causing serious injury or death. Always use replacement tires and tubes that are sized to be compatible with your ebike frame. For safety, and if required by law, ensure replacement tires have sufficient reflective sidewall striping.

After replacing a tire or removing the wheel for any other reason, be sure to tighten your axles according to the values listed in [“Tools and torque specifications” on page 11](#). For more information on tire or tube replacement, visit radpowerbikes.com/help.

Handlebar twist and push tests

 **WARNING:** An improperly secured wheel and/or handlebar stem can cause loss of control, accidents, serious injury, or death. Check that the front wheel and handlebar stem are properly secured during assembly and before each ride.

HANDLEBAR TWIST TEST

1. **Get the ebike ready for testing.** Turn off the ebike, remove the battery, and press and hold the power button to discharge remaining power.
2. **Brace the front wheel.** Stand at the front of the ebike, facing the handlebar, and brace the front wheel between your feet and lower legs.
3. **Try to twist the handlebar.** Hold both handlebar grips and push forward with one hand while pulling back with the other. Push and pull at the same time with about 20 lb of force with each hand.
4. **Ensure the handlebar and wheel stay properly aligned.** The handlebar and handlebar stem must be tightly secured, and the handlebar perpendicular to the front wheel.
5. **Repeat the twist test pulling/pushing with the opposite hands,** using about 20 lb of force pushing with one hand and 20 lb of force pulling with the other hand.
6. **Check for any movement or changes in alignment of the stem and handlebar relative to the front wheel.** If there was no alignment change, skip the next step, reinstall your battery, and test your ebike fully before riding. If you did *not* notice change in alignment, proceed to the next step. Be sure to tighten your bolts according to the values listed in [“Tools and torque specifications” on page 11](#).

HANDLEBAR PUSH TEST

This test will involve applying force directly to your handlebar to see whether it could pivot unexpectedly during operation. The illustration at right shows the type of motion this procedure tests for.

1. **Get the ebike ready for testing.** Turn off the ebike, remove the battery, and press and hold the power button to discharge remaining power.
2. **Make sure your handlebar is centered on the stem.** Your handlebar has the widest diameter at its center. If it isn't centered, it could come loose. Center your handlebar, loosening and re-tightening the stem faceplate bolts as necessary.
3. **Brace your front wheel.** Roll your ebike up to a wall so that your front wheel is touching the wall and is perpendicular to the wall. Stand over your frame as though you're about to ride it, and then sit down. If necessary, lower the seat so that you can sit on it while your feet are on the ground. Place both hands on the handlebar and squeeze the brake levers.
4. **Push your handlebar.** Begin by pushing with medium force, watching for any pivot in the handlebar. Increase the force until you are pushing as hard as you can, ideally with 100 lb of total force.
5. **If your handlebar did not pivot, it's tight enough.** If your handlebar did pivot, you will need to loosen and re-tighten the stem faceplate bolts as described in the assembly instructions. Be sure to torque the bolts according to [“Tools and torque specifications” on page 11](#).

 **WARNING:** Improperly securing your handlebar, stem, or stem riser can result in loss of control of your ebike, serious injury, or death. If you are not sure you have the experience, skills, and tools to correctly perform all steps to secure and verify the security of the handlebar, front wheel, and handlebar stem you **MUST** consult a professional, reputable bike mechanic to check your work and/or secure those components to the ebike properly.

Guard against rust, corrosion, and water damage



WARNING: Damage to your ebike's electrical system caused in any manner, including water intrusion, can lead to battery failure, electrical system malfunction, or electrical fire and consequent property damage, injury, or death. Follow all instructions to minimize chance of water damage. If you have any questions, contact Rad Power Bikes Product Support.

Like any vehicle used outdoors, your Radster Trail needs care to ensure it isn't damaged by the elements. Follow these steps for a long, healthy life for your ebike:

- Store under shelter and in an upright position; avoid leaving the ebike in the rain or exposed to corrosive substances such as water, salt, or de-icing substances. If exposed to rain, dry your ebike afterward, and apply an anti-rust treatment to the chain and other unpainted steel surfaces.
- To clean your ebike, turn it and the battery off and wipe the frame with a clean, damp cloth. If needed, apply a mild, non-corrosive detergent mixture to the damp cloth and wipe the frame. Dry by wiping with a clean, dry cloth. **Never use high-pressure water on your ebike.** Wipe down your ebike frequently and wipe or spray all unpainted mechanical parts with anti-rust treatment.
- If painted metal parts become scratched or chipped, use touch up paint or nail polish to prevent rust.
- **Never immerse or submerge the ebike or any components in water or liquid, which can damage the electrical system.**
- Avoid riding on the beach, in coastal areas with high-salinity fog, or on surfaces treated with salt or de-icing compounds. Doing so exposes your ebike to salt or other substances that are very corrosive. Corrosion of electrical components can lead to permanent damage that can cause battery failure, electrical system failure, or electrical fire. Damage from corrosion is not covered under warranty.

Troubleshooting

Problem	Most common solutions
Ebike doesn't work:	
Insufficient battery power	Charge the battery
Battery not fully seated in tray	Install battery correctly
Faulty connections	Clean and reconnect connectors
Improper turn-on sequence	Turn on ebike in proper sequence
Brake is squeezed	Disengage brake
Throttle stops working:	
Communications error with or without error 30 displayed	Consult our Help Center at radpowerbikes.com/help .
Irregular acceleration and/or reduced top speed:	
Insufficient battery power	Charge or replace battery
Unexpected PAS level setting	Check PAS level
Loose or damaged throttle	Replace throttle
When powered on, the motor does not respond:	
Loose wiring	Reconnect or replace cable(s)
Loose or damaged throttle	Tighten or replace throttle

Loose or damaged motor cable	Reconnect or replace motor cable
Damaged motor	Replace motor

Reduced range:

Low tire pressure	Check for tire punctures or other damage. Inflate tires to PSI stamped on sidewall.
Low battery	Charge battery
Driving with too many hills, headwind, braking, or excessive load	Assist with pedals or adjust route
Battery discharged for long period without regular charges	Recharge the battery. If range decline persists, consult our Help Center at radpowerbikes.com/help .
Brakes rubbing	Adjust the brakes
Faulty, damaged, or aged battery	Contact Rad Power Bikes Product Support to replace battery. Disconnect and store damaged battery in a safe location and recycle or dispose of as soon as possible according to local rules.

The battery won't charge:

Charger not well connected	Adjust the charger connection
Charger damaged	Replace the charger
Battery damaged	Immediately stop use. Disconnect and store battery in a safe location and recycle or dispose of as soon as possible according to local rules. Contact Rad Power Bikes Product Support to replace battery.
Wiring damaged	Replace wiring

Wheel or motor makes strange noises:

Loose motor cable connection	Reconnect cable
Damaged wheel spokes or rim	Repair or replace damaged component(s)
Damaged motor	Replace motor

Error detection

Your Radster Trail is equipped with an error detection system integrated into the Color Display and motor controller. In the case of an electronic control system fault, an error code will appear on the display. Some errors are simple to resolve on your own; others may require extra troubleshooting and/or replacement parts to resolve. If your bike displays an error code at any time, stop riding and look up the error code information at radpowerbikes.com/help.

The following error codes are the most common:

Error	Definition
6	Battery undervoltage error
10	Battery overvoltage error
12	Motor stall warning
15	Torque sensor error
16	Controller error
17	Throttle on at startup
21	Abnormal motor current
22	Throttle fault
23	Motor phase fault

Error	Definition
24	Motor hall fault
25	Brake switch fault or the brake applied while turning on
30	Communication error
34	Stuck button error

Ride as safely as possible

Operating any bike or ebike is an exciting, delightful, and practical way to get around, but like any sport, it involves risk of injury and death. By choosing to ride any bike or ebike, you assume responsibility for those risks.



WARNING: Incorrect assembly, maintenance, or use of your ebike can cause component or performance failure, loss of control, serious injury, or death. Ebikes have parts that non-motorized bikes do not have, and neither the assembly video, assembly steps, or the rest of the manual cover all potential aspects of ebike configuration, maintenance, and repair, which can require specialized tools and skills. We strongly recommend you consult a professional, reputable bike mechanic to assist in the assembly, repair, and maintenance of your ebike, or inspect your work if you choose to do it yourself.

Age and ability requirements

You must be age 16 or older to operate the Radster Trail. You must also have the physical ability, reaction time, and mental capability to understand and obey all local laws governing ebike usage and to manage traffic, variable road conditions, and sudden situations. If you have an impairment or disability (e.g., visual impairment, hearing impairment, physical impairment, cognitive or language impairment, seizure disorder) or any other limitation that could affect your ability to safely operate a vehicle, consult your physician before operating any bike, ebike, or similar vehicle.



WARNING: This ebike is not to be operated by anyone under the age of 16. Children under the age of 16 may lack the necessary judgment and skill to safely operate the ebike, potentially resulting in damage to the ebike, damage to other property, serious injury, and/or death. Please also check your local laws, which may require a higher age. It is your responsibility to know and obey local regulations regarding rider age and other qualifications.



MINIMUM
OPERATOR AGE



DANGER: Riding any vehicle under the influence of alcohol, drugs, or any substance or condition that could impair your motor function, judgment, reaction time, or ability to safely operate a vehicle puts you at VERY HIGH RISK of serious injury or death. Operate your ebike or other vehicles only when you're sober and otherwise physically and mentally prepared to ride safely.

Know and obey all relevant local laws

It is your responsibility to research and understand relevant laws where you ride your Radster Trail, which meets the criteria for a Class 3 ebike in the United States. Local laws may cover required helmets and safety gear, required lights and reflectors, required hand signals, where you can legally ride an ebike (bikes and ebikes may have different restrictions), how fast you can go, what (if any) cargo or passengers you can carry, rider age, and more. Before using public transportation—buses, trains, etc.—to transport your ebike, check with the relevant transportation authority for any rules governing weight limits, tire widths, lithium-ion batteries, or any other rules that might pertain to your Radster Trail. Make sure you know ahead of time whether and how high you will need to lift your ebike, and make sure you can do that safely.

When you ride on the road, assume you must, at minimum, follow all of the rules that cars must follow. For additional information regarding traffic and vehicle laws, contact the road traffic authority in your area.

Ride appropriately for conditions

Always travel at speeds appropriate for local terrain and conditions as well as your experience level. **When in doubt, slow down.**

Ride with your headlight on, which will make you more visible in any conditions. The headlight will turn on when the ebike is powered on. We recommend you keep it on whenever you ride.

Concentrate on the path ahead. Avoid potholes, gravel, ice, wet or oily roads, wet leaves, curbs, train tracks, speed bumps, drain gates, thorns, broken glass, and other obstacles, hazards, and puncture-flat risks.



WARNING: Crossing train tracks or similar grooved or raised surfaces at a diagonal can make the surface “grab” or deflect your wheel, causing your ebike to suddenly get stuck or crash, leading to serious injury or death. Always cross such hazards at a perpendicular angle or, when in doubt, dismount and walk your ebike across.

PATH RIDING

Be a good citizen of shared-use paths and facilities. Keep your speed reasonable and below path speed limits, pass carefully and kindly. Use your voice and/or bell to signal your presence to others, especially when passing. Keep in mind that your ebike is heavy, can go at high speeds, and can hurt others if not operated with care.

ROAD RIDING

When riding on streets, obey the same road laws as all other road vehicles as well as local rules governing bike or ebike usage. Sharing the road with other vehicles presents many hazards. Always take these precautions:

- Expect the unexpected such as opening car doors or cars backing out of driveways.
- Be extra careful at intersections and when preparing to pass other vehicles or other cyclists.
- Ride predictably, in a straight line, and with the flow of traffic. **Never ride against traffic.**
- Use correct hand signals to indicate turning, and do so well in advance of turning.
- Ride defensively. To other road users you may be hard to see.
- Increase your visibility by following the tips in [“Low-visibility conditions” below](#).

OFF-ROAD RIDING

Riding off road requires close attention and specific skills, and it presents variable conditions and hazards. Don’t ride off road unless you have the appropriate skills. If you choose to ride off road, wear appropriate safety gear and do not ride alone in remote areas.

LOW-VISIBILITY CONDITIONS



WARNING: Riding at night or in other low-visibility conditions (dawn, dusk, fog, rain, mist, snow, etc.) makes it harder to see and avoid hazards and makes it harder for others to see and avoid you, which increases risk of accidents, serious injury, or death. Wet, slippery surfaces will compound your risk of injury or death. Avoid these conditions whenever possible. If you must ride in these conditions, following the guidelines below can reduce risk.

- Wear reflective and brightly colored clothing.
- Slow down.
- Use familiar routes with street lighting if possible.
- Ensure tire wall, pedal, and other reflectors are installed and unobstructed.
- Ensure headlight and taillight/brake light are functioning correctly and unobstructed. Use them.

WET CONDITIONS

Your Radster Trail is not meant for use in puddles, heavy rain, or streams. Never immerse or submerge this product in water or liquid as the electrical system may be damaged.



WARNING: Riding in wet conditions means slippery hands, feet, and riding surfaces, which greatly increases your risk of accidents, serious injury, or death. Low-visibility conditions (night, dusk, dawn, fog, mist, rain, snow, etc.) will compound your risk of injury or death. Avoid riding in such conditions. If you choose to ride in wet conditions, you do so at your own risk. Follow the recommendations below to reduce that risk.

- Decrease riding speed to help you control the ebike in slippery conditions.
- Brake earlier since it will take longer to slow down than in dry conditions.
- Take care to be more visible to others on the road, following the tips in [“Low-visibility conditions” above](#).
- Remember that road hazards are more difficult to see when wet, so proceed with extra caution.

EXTREME RIDING

There are no appropriate conditions for extreme riding. Although many articles, advertisements, and catalogs depict extreme riding, Rad Power Bikes strongly advises against such inappropriate and dangerous use of its products.



DANGER: Extreme riding puts you at **VERY HIGH RISK** of serious injury or death. Extreme riding includes but is not limited to jumps, stunts, or any riding that exceeds your capabilities or the strength and integrity limitations of certain ebike components and/or otherwise leads to dangerous situations. Never engage in extreme riding or any type of riding that exceeds your capabilities.

Wear a helmet and appropriate safety gear

We strongly advise that you and any passenger you carry wear a properly fitting, certified bicycle safety helmet while riding your ebike, which may be required by law in your area.

Wear appropriate safety gear including closed-toe shoes. If you are wearing loose pants, secure the bottom using appropriate leg clips or bands to prevent the fabric from flapping and getting caught in the chain or other moving parts. Never use items such as headphones or hoods that can compromise your hearing or field of vision. A local, professional, reputable bike shop can help advise you on what gear is best for the weather and other riding conditions in your area.

Maximize your visibility with bright colors and reflective outerwear or vests. Never compromise your ability to be seen or heard by removing your ebike's reflectors, blocking or removing the headlight or taillight, or removing the bell.



DANGER: Riding any bike, ebike, or similar vehicle without a helmet puts you at **VERY HIGH RISK** of serious head injury or death. Always wear a properly fitted helmet that covers the forehead. Many locations require specific safety devices. It is your responsibility to familiarize yourself and comply with the laws, rules, and regulations where you ride.



WEAR A HELMET

Limited Warranty Terms

This Limited Warranty is issued by Rad Power Bikes (“RPB”), a Seattle, WA corporation. It is applicable for products listed below purchased in the U.S.A or Canada after January 1, 2024.

This Limited Warranty extends to the original purchaser of the Warranted Product(s) under this Limited Warranty and to each transferee of the Warranted Product(s) during the term(s) as provided below, provided that the product (s) were originally purchased from RPB’s online storefront, a physical RPB retail storefront, or an authorized RPB retail partner. If purchased through an RPB retail partner, a receipt of purchase must be submitted to RPB.

The Limited Warranty begins from the original owner’s receipt or purchase date (whichever is later) and will be verified by RPB (“**Warranty Begin Date**”).

Warranted Products

The Warranted Products are warranted to be free of defects in materials and/or workmanship during the periods identified below:

- **Bike Frame and Components:** 2-year Limited Warranty from Warranty Begin Date for the replacement of a defective frame, forks, stem, handlebar, headset, seat post, brakes, lights, bottom bracket, rims, wheel hub, and reflectors.
- **Battery:** 2-year Limited Warranty from Warranty Begin Date or up to 300 recharge cycles (approximately 6,000 miles of riding). Proper Battery care and charging should result in up to 75% of original capacity remaining during this timeframe.
- **Additional Frame & Component Items:** 1-year Limited Warranty from Warranty Begin Date for pedals, freewheel, crankset, cassette, derailleur, shifter, and saddle.
- **RPB Branded Optional Accessories:** 1-year Limited Warranty from Warranty Begin Date.

Limited Warranty Labor

Labor will be provided for any Warranted Product(s) above with approval from RPB prior to the service being conducted.

Wear and Tear

Wear and tear is not covered under this Limited Warranty. Wear and tear are terms to describe damage or wear that occurs as a result of normal use. As a result, not all products are covered in this Limited Warranty. For example, your tires and tubes will wear out over time, which are not covered by this Limited Warranty. In addition, items like brake pads will wear with use. As a further example, while the brake caliper is covered by the Limited Warranty, the pads are not. Furthermore, scratches and other potential damage to the paint, or bike graphics because of normal use and exposure to the elements are not covered. Listed below is a non-exhaustive list of other typical wear and tear items:

- Brake Pads
- Chains
- Chainring
- Derailleur Pulley Wheels (Part of Derailleur Assembly)
- Shift/Brake Cables and Housing
- Hydraulic Brake Hose and Fluid
- Tires
- Tubes
- Frame Paint/Decals
- Bearings (Headset, Bottom Bracket, Front Hub)
- Spokes

This Limited Warranty Does Not Cover

- Any damage or defects to Warranted Product(s) resulting from failure to follow instructions in the ebike owner's manual, acts of God, accident, misuse, neglect, abuse, commercial use, alterations, modification, improper assembly, installation of parts or accessories not originally intended or compatible with the ebike as sold, operator error, water damage, extreme riding, stunt riding, or improper follow-up maintenance.
- For the avoidance of doubt, RPB will not be liable and/or responsible for any damage, failure or loss caused by any unauthorized service or use of unauthorized parts.
- The Battery is not warranted from damage resulting from power surges, use of an improper charger, improper maintenance or other such misuse, normal wear or water damage.
- Rust or corrosion.
- Improper maintenance, assembly, or installation.
- Use of the ebike for abnormal, competitive, commercial activities, or any purposes beyond its intended design.
- Modifications from the original condition.
- Improper modification, alteration or installation of components, parts, or accessories not originally intended for or compatible with the ebike.
- Paint finishes and decal damage resulting from taking part in competitions, jumping, downhill and/or training for such activities or events, or from exposing the bike to, or riding it in, severe conditions or climates.

DETERMINING WHETHER DAMAGE OR DEFECT TO AN EBIKE OR A WARRANTED PRODUCT(S) IS PROTECTED BY THIS LIMITED WARRANTY SHALL BE IN THE SOLE DISCRETION OF RPB. PLEASE CONTACT RPB CUSTOMER SERVICE WITH ANY QUESTIONS.

Claims Process

RPB WILL NOT REPLACE ANY WARRANTED PRODUCT(S) UNDER THIS LIMITED WARRANTY WITHOUT FIRST SEEING PHOTOS OR VIDEO OF THE DAMAGED WARRANTED PRODUCT(S).

In order to exercise your right to receive a replacement for a Warranted Product(s) under this Limited Warranty, you must:

Contact the RPB Customer Service team through our Help Center (<https://support.radpowerbikes.com>). The Customer Service team will initially work with you on the problem with your ebike to identify potential simple fixes.

If the Customer Service team determines that a Warranted Product(s) must be replaced, they will provide you with a set of instructions for having a Rad Authorized Service Provider fixing the issue and/or returning the defective Warranted Product(s) and receiving the replacement.

After you receive the replacement Warranted Product(s), the Customer Service team will also assist in determining how to replace or install the new Warranted Product(s) into your ebike.

You will be responsible for shipping costs associated with returning a Warranted Product(s), unless RPB agrees in writing to pay for such shipping costs. Replacement Warranted Product(s) under this Limited Warranty shall only be shipped to the address of the original purchaser.

THE REMEDIES DESCRIBED ABOVE ARE YOUR SOLE AND EXCLUSIVE REMEDIES AND RPB'S ENTIRE LIABILITY FOR ANY BREACH OF THIS LIMITED WARRANTY. RPB'S LIABILITY SHALL UNDER NO CIRCUMSTANCES EXCEED THE ACTUAL AMOUNT PAID BY YOU FOR THE EBIKE, NOR SHALL RPB UNDER ANY CIRCUMSTANCES BE LIABLE FOR ANY CONSEQUENTIAL, INCIDENTAL, SPECIAL OR PUNITIVE DAMAGES OR LOSSES, WHETHER DIRECT OR INDIRECT.

SOME STATES DO NOT ALLOW THE EXCLUSION OR LIMITATION OF INCIDENTAL OR CONSEQUENTIAL DAMAGES, SO THE ABOVE LIMITATION OR EXCLUSION MAY NOT APPLY TO YOU.

THIS LIMITED WARRANTY GIVES YOU SPECIFIC LEGAL RIGHTS AND YOU MAY ALSO HAVE OTHER RIGHTS, WHICH VARY FROM STATE TO STATE.

TO THE EXTENT PERMISSIBLE UNDER APPLICABLE LAW, RPB DISCLAIMS ALL IMPLIED WARRANTIES, INCLUDING WITHOUT LIMITATION THE WARRANTIES OF MERCHANTABILITY AND FITNESS FOR A PARTICULAR PURPOSE FOR THE DURATION OF THIS EXPRESS LIMITED WARRANTY.

SOME STATES DO NOT ALLOW LIMITATIONS ON HOW LONG AN IMPLIED WARRANTY LASTS, SO THE ABOVE LIMITATION MAY NOT APPLY TO YOU.

Watch the assembly video!

Get your latest manual!

We do our best to make this manual as clear, comprehensive, and accurate as possible, but sometimes we learn new things, catch errors, improve explanations, or add important new safety information. The manual you're reading right may not be the latest version unless you just downloaded it.

Please go to our Help Center at radpowerbikes.com/help to download the latest manual and to watch your assembly video so you can have the safest, most enjoyable experience with your new ebike!

Thanks for riding Rad!