

**SOLENOID OPERATED VALVES
 POPPET 2-WAY NORMALLY CLOSED
 SPECIAL CAVITY**

VEI-8A-2A-09-NC-S-NSS

017-E

OD.15.05.17 - Y - S0

PATENT PENDING

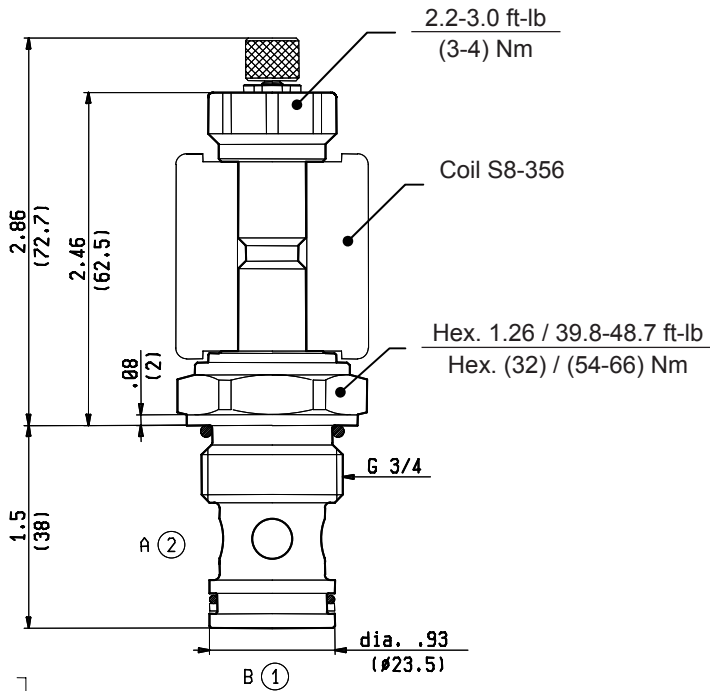

Inches
(mm)

TECHNICAL DATA

Maximum Operating Pressure	5000 psi (350 bar)
Fatigue Cycle Life at 5000 psi (350 bar) and 0.5 Hz (1 s ON - 1 s OFF)	10 million cycles
Rated Flow	19 gpm (70 l/min)
Cavity - Tooling (017-E)	page CT.S.006.U
Line bodies	page MN2.S...
Weight	0.485 lbs (0.220 kg)
Fluids - Temperatures	page 7.01.040
Testing Conditions - Seals	page 7.01.040
Internal Leakage	page 7.01.040
Filtration : 25 µm nominal or better	page 7.01.050
Minimum Voltage Required	90% of nominal
Coils must be ordered separately	page 1.71.042
Mounting Position	unrestricted

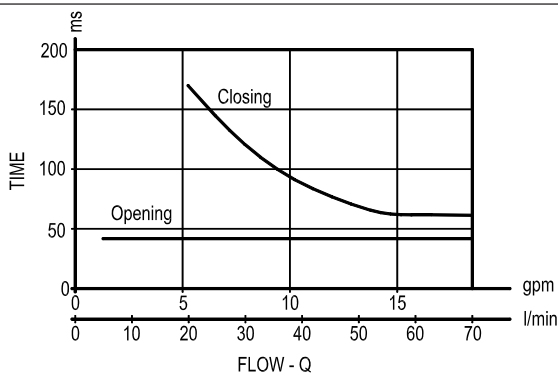
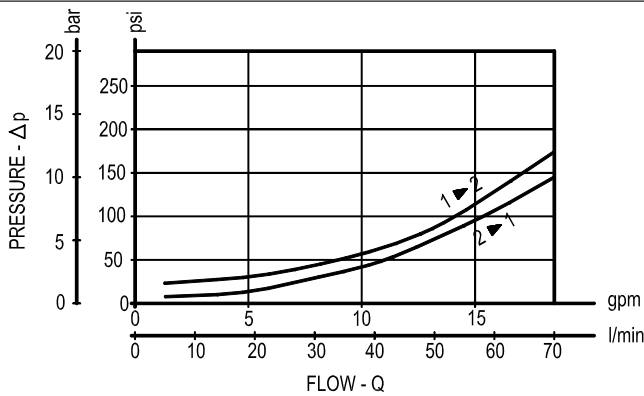

Y ORDERING OPTIONS

3A Standard

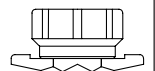

3B Knob Style Manual Override

