

76263

SAE "C" TO SAE "C" WET

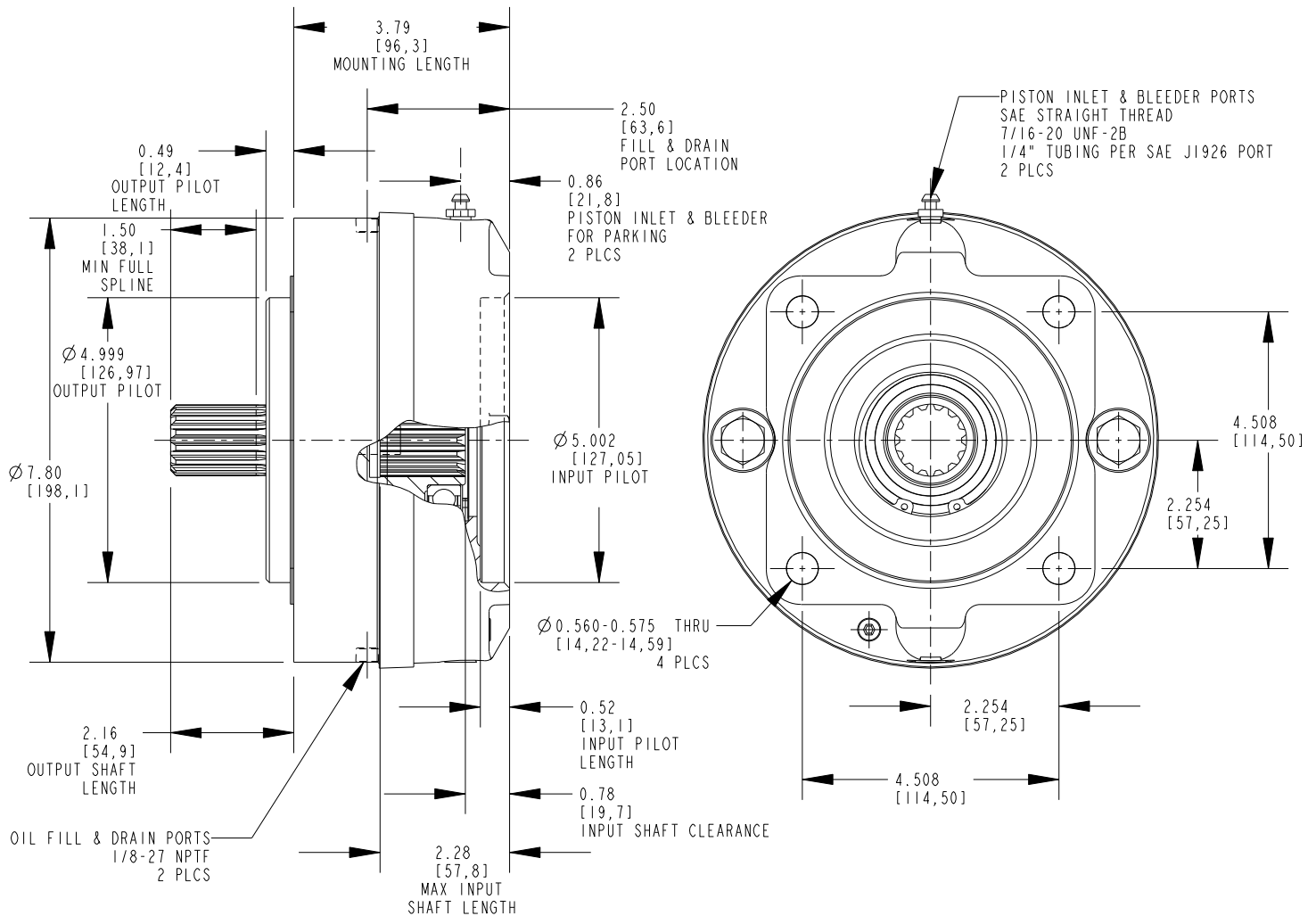

RATED TORQUE	2200 (249)
FULL RELEASE PRESSURE	120 (8)
INPUT SPLINE (INTERNAL)	14T 12/24 ANSI B92.1 SIDE FIT 30° PRESSURE ANGLE
OUTPUT SPLINE (EXTERNAL)	14T 12/24 ANSI B92.1 SIDE FIT 30° PRESSURE ANGLE
OIL FILL VOLUME HORIZONTAL (mL)	100
OIL FILL VOLUME VERTICAL (mL)	250
O-RING SERVICE KIT	PK-1368
STACK SERVICE KIT	PK-1367
BEARING SERVICE KIT	PK-933
GASKET SERVICE KIT	PK-679

- * UNITS: LENGTH, DIAMETER = IN (mm), PRESSURE = PSI (BAR), TORQUE = LBS IN (Nm)
- * MAX OPERATING PRESSURE FOR PARKING IS 3000 PSI (207 BAR).
- * PRESSURE SPIKES OR SURGES ARE NOT TO EXCEED 4000 PSI (276 BAR).
- * BRAKE CAVITY COOLING OIL PRESSURE NOT TO EXCEED 15 PSI (1 BAR).
- * MAXIMUM HORIZONTAL OPERATING SPEED IS 5000 RPM.
- * FOR VERTICAL APPLICATION, CONTACT AUSCO FOR MAX SPEED DETAILS.
- * REVIEW IMPORTANT NOTES ON GENERAL INFORMATION.