

## ErgoBed 450

*Good sleep changes everything*



### OWNER'S MANUAL

Actual product appearance and functionality may vary from photographs, illustrations and descriptions included in this manual.

<b>ENGLISH</b>	1
<b>PORTUGUESE</b>	23
<b>ESPAÑOL</b>	45
<b>LATVIAN</b>	67
<b>GREEK</b>	89
<b>ESTONIAN</b>	111
<b>ROMANIAN</b>	133
<b>FRENCH</b>	153
<b>FINNISH</b>	173
<b>GERMAN</b>	193
<b>HEBREW</b>	213

# ENGLISH

<b>Safety Precautions and Usage Statements</b>	2
<b>Parts List</b>	7
<b>Base and Remote Overview</b>	8
<b>Quick Reference Guide</b>	10
<b>Installation Guide</b>	10
<b>Remote Control</b>	13
<b>Remote Control Pairing</b>	14
<b>Power Down Box</b>	16
<b>Syncing Two Bases (Optional)</b>	17
<b>Connecting Strap (Optional)</b>	18
<b>Headboard Bracket Installation Guide (Optional)</b>	19
<b>Troubleshooting</b>	22

## Safety Precautions and Usage Statements

### **Attention: Important Safety Disclaimers**

**Read all instructions before using your adjustable base. Save these instructions.**

### **TO REDUCE THE RISK OF SHOCK, BURNS, FIRE OR INJURY:**

For optimal safety and operation, plug bed base into a surge protector (not included). The bed base should only be plugged directly into a wall outlet or surge protector (strongly recommended). Always unplug the base from the electrical outlet before servicing any part of the base. To reduce risk of electric shock, unplug the base before cleaning. To safely disconnect, ensure the base is in a flat position with all motors off, and unplug from power source. Keep the power cord away from heated surfaces. Never operate the base when the air openings are blocked. Keep air openings free of lint, hair and the like. Do not drop or insert any object into any opening. Discontinue use of the bed base and contact a qualified service center if: it has a damaged cord or plug, if it is not working properly, or it has been dropped into water. Only use this bed base for its intended use as described in this manual. Do not use accessories/attachments that are not recommended by the manufacturer. Close supervision is required when the bed base is used by or near children, convalescents, disabled persons or pets. Improper connection of the equipment can result in the risk of electrical shock, electrical fire or faulty operation of this bed base. If the plug does not fit your outlet, contact a qualified electrician to install a suitable outlet. Unauthorized modification or failure to use a wall outlet or surge protector could void the electrical portion of your warranty.

### **PETS AND CHILDREN:**

Immediately dispose of all packing materials as it may pose a smothering risk to small children and pets. To avoid injury, it is not advised to allow children and small pets to play on or under the bed. Children should not operate the bed base without adult supervision.

### **PACEMAKERS:**

Some products contain Neodymium MAGNETS which may interfere with devices such as pacemakers, ICD's and any other device sensitive to magnetic fields. It is STRONGLY recommended that owners of such medical devices consult their physician prior to using products that contain Neodymium MAGNETS. It is also possible that some pacemakers may falsely interpret the optional massage feature vibrations as movement/exercise. This is a common occurrence with any products that creates a vibrating movement and may not affect the pacemaker. Please consult your physician before using the massage feature.

## **IN-HOME USE AND HOSPITAL STANDARDS:**

Ergomotion adjustable bed bases are designed solely for in-home use. This base was not designed as a hospital bed and is not designed to meet hospital standards. Do not use this base with TENT TYPE oxygen therapy equipment or near explosive gases.

## **ADDITIONAL SAFETY FEATURES**

Casters (optional leg accessory) are equipped with locking wheels to prevent unwanted movement. Even when locked and unable to roll, it is possible for the casters to slide. Free release head and foot motors are designed to lower the mattress by retracting only with gravity, never pulling downwards, which minimizes pinch points.

## **LIFTING/LOWERING MECHANISMS**

The lift/lower feature will emit a minimal humming sound during operation. This is normal. During operation, the lift arm wheels make contact with the platform support of the base. This contact may result in metal on metal or metal on plastic contact. This applies slight tension on the moving components and resonance is reduced to a minimum level. If excessive noise or vibration is experienced, reverse the movement action (up or down) of the base with the remote control. This should realign the base's activating mechanisms to the proper operational position. In normal base operation, the wheels, which allow the bed to maintain its distance from the wall, will make contact with the steel platform supports of the base creating a contact noise. When entering, exiting or shifting weight on the base, this contact noise may be audible as the wheels make contact. This is normal.

## **MATERIALS**

Ergomotion adjustable bases are constructed from various materials including woods, metals, plastics and fabrics. Tension, pressure or movement applied to the frame, platform or shroud through general use may create an audible sound.

## **MESSAGE OPERATION AND LOCATION ENVIRONMENT**

The massage feature will emit a tone during operation. This is normal. As the massage intensity level is increased, the tone will intensify. The volume of this tone is directly related to the location environment. For example, when demonstrated in a show room, the surrounding environmental noise will cover some of the massage noise. However, when installed in a home setting with wooden floors, carpeted or not, the massage volume will be more noticeable. To minimize this resonance, place a piece of carpet, or rubber caster cups, under each leg or caster of the base. It is possible to experience vibration or noise from the exterior bed frame, headboard brackets, headboards or footboards if mounting bolts are not firmly tightened.

Levels 1-6 of massage intensity represent the revolutions of the motor per minute. Level 6 provides the maximum number of RPMs. However, this does not mean that the feeling of vibration is the strongest. Depending on the mattress material, thickness, and positioning

of the user, the feeling of vibrations will differ. We encourage the user to find the massage intensity setting that suits them best. It is important to understand the physics of vibrations. Just as an engine may run rough during idle, as the RPMs increase, the vibrations change concurrently.

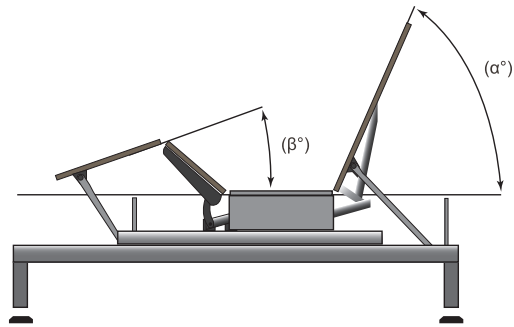

## TOLERANCE

All Ergomotion adjustable foundations, depending on make and model, are designed and manufactured to perform and function within designated quality control parameters. Bases are subject to meticulous and rigorous inspections during the quality control process to ensure bases will operate within these standards during normal operating use. Normal operating use is defined as the following: Adjustable foundation is to be operated with a mattress and load. Testing procedures require lifetime cycle tests with up to 120kg distributed load. The angle (designated “ $\alpha$ ” in figure 1) between the back section and the flat section for various configurations of the mattress support platform shall be  $\pm 3^\circ$ , which translates to a tolerance of up to  $1\frac{1}{2}''$ .

The angle (designated “ $\beta$ ” in figure 1) between the flat section and foot section for various configurations of the mattress support platform shall be  $\pm 3^\circ$ , which translates to a tolerance of up to  $\frac{3}{4}''$ .

Any adjustable foundation deemed to be within these allocated tolerances is considered to have met the manufacturer’s quality control standards.

## THAT “NEW PRODUCT” SMELL:

Some people notice a slight odor to their new adjustable base—this can come from our material manufacturing process. This smell is normal and usually disappears before the product reaches you. Sometimes, however, this smell may still be noticeable. It usually disappears after a few weeks, providing adequate ventilation of the product and the environment.

## BREAK IN PERIOD:

You can speed up the break-in period by simply spending time in the adjustable bed through activities such as reading, watching TV or playing with the kids or grandkids. The extra movement will help the adjustable base respond to weight and temperature

changes. Some of the materials in our adjustable bases such as the woods, metals and plastics used in the platform, frame and components are sensitive to moisture content and temperature and may make sounds in colder environments.

## **PAIRED OPERATION:**

When operating a “paired” split base setup there may be a time latency up to 1.5 seconds between each bases articulation.

## **WEAR AND TEAR:**

Wear and tear is damage that naturally and inevitably occurs as a result of normal use or aging.

## **FABRIC CARE:**

To prolong the life of your fabric, protect from direct sunlight whenever possible. For spot cleaning, wipe area with a light damp sponge or vacuum with a soft brush attachment to remove particles. Keep at a minimum of 30cm (12 inches) away from direct heat sources. For a deeper cleaning, blot liquid spills with a clean dry cloth. Wipe with a clean cloth dampened with warm water. Do not wet excessively. A soft bristle brush may be used to remove ingrained soil. Avoid scratching by gentle brushing. Wipe with a clean cloth dampened with warm water to remove residues. Dry in shade away from direct heat. If persistent marks remain visible after cleaning, seek professional advice.

## **PRODUCT RATINGS:**

The lift motors are not designed to operate continuously for more than [2] minutes in an [18] minute time period or approximately 10% duty cycle. Attempting to circumvent or exceed this rating will shorten the life expectancy of the product and may void the warranty. The massage motors are not designed to operate continuously for more than 30 minutes at a time. Please allow the massaging system to rest for 30 minutes after automatic massage shut off before restarting.

## **WEIGHT LIMITS:**

This product is not rated to support weights in excess of 340 kg inclusive of the mattress and bedding. The base will structurally support this weight, provided it is evenly distributed across the bed base. The adjustable base is not designed to support or lift this amount in the head or foot sections alone. Exceeding this weight restriction could damage the bed and/or cause injury and will void the warranty.

## **IMPORTANT DO'S AND DON'TS**

### **DO:**

- Plug your adjustable base into a power surge protector.
- Evenly distribute weight when sleeping in a split setup. Uneven distribution of weight can cause the base to raise unevenly.

- Call Customer Service for any technical issues. Do not try to force the base down, this can damage the motors or frame.
- Use mild soap and water to clean your adjustable base if staining occurs.
- Keep in mind that adjustable bases are recommended to be used with adjustable friendly mattresses.
- Lower to the flat (horizontal) position after use and in between presets.
- Register your warranty as soon as your adjustable base has been delivered.

#### **DON'T:**

- Sit on corners/edges of base, this may warp the frame, struts or foam.
- Tilt the base on its side. This can damage the legs and/or leg screws.
- Stand or jump on the adjustable base at any time, this can damage the frame and motors.
- Drag the base to move it. Dragging the base could damage the frame, strip the nut/bolts or break the legs. Purchase castors if you plan on moving your base routinely.
- Enter and exit the adjustable base with the head and/or foot in the articulated position. Enter or exit your adjustable in the flat (horizontal) position.
- Tinker with or modify base. This will void the warranty.
- Press down on the head or foot while actuated can damage frame and motors.

#### **FCC Compliance:**

**NOTE:** This equipment has been tested and found to comply with the limits for a Class B digital device, pursuant to part 15 of the FCC Rules. These limits are designed to provide reasonable protection against harmful interference in a residential installation. This equipment generates, uses and can radiate radio frequency energy and, if not installed and used in accordance with the instructions, may cause harmful interference to radio communications. However, there is no guarantee that interference will not occur in a particular installation. If this equipment does cause harmful interference to radio or television reception, which can be determined by turning the equipment off and on, the user is encouraged to try to correct the interference by one or more of the following measures:

- Reorient or relocate the receiving antenna.
- Increase the separation between the equipment and receiver.
- Connect the equipment into an outlet on a circuit different from that to which the receiver is connected.
- Consult the dealer or an experienced radio/TV technician for help.

**SAVE THESE INSTRUCTIONS**



# Parts List

**Before discarding the packing materials, ensure all the parts are accounted for.**

**All electronics and components that need to be installed are located in boxes under the base or attached to the frame.**

- A. Wireless Remote Control and AAA Batteries (3)
- B. Mattress Retainer Bar\*
- C. Legs (4)
- D. Power Cord
- E. Power Supply
- F. Power Down Box (9 volt alkaline batteries not included)
- G. Connecting Strap†\*
- H. Sync Cord‡



## Misc Parts (not included):

- I. Surge Protector
- J. 9 Volt Alkaline Batteries (2)

\* These items are attached to the base for shipping purposes. Carefully remove from base and set aside.

‡ Only included in the width of the bases  $\leq 1000\text{mm}$ .

## MISC Parts (NOT INCLUDED)



## Base and Remote Overview

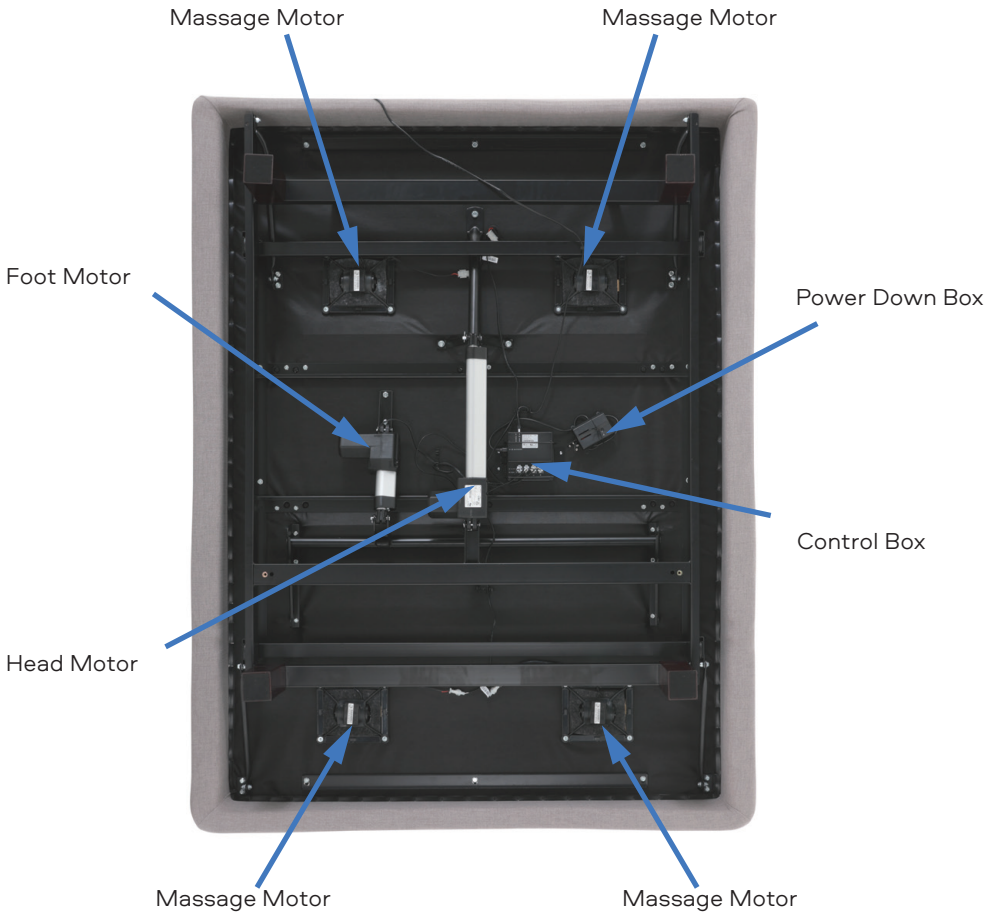

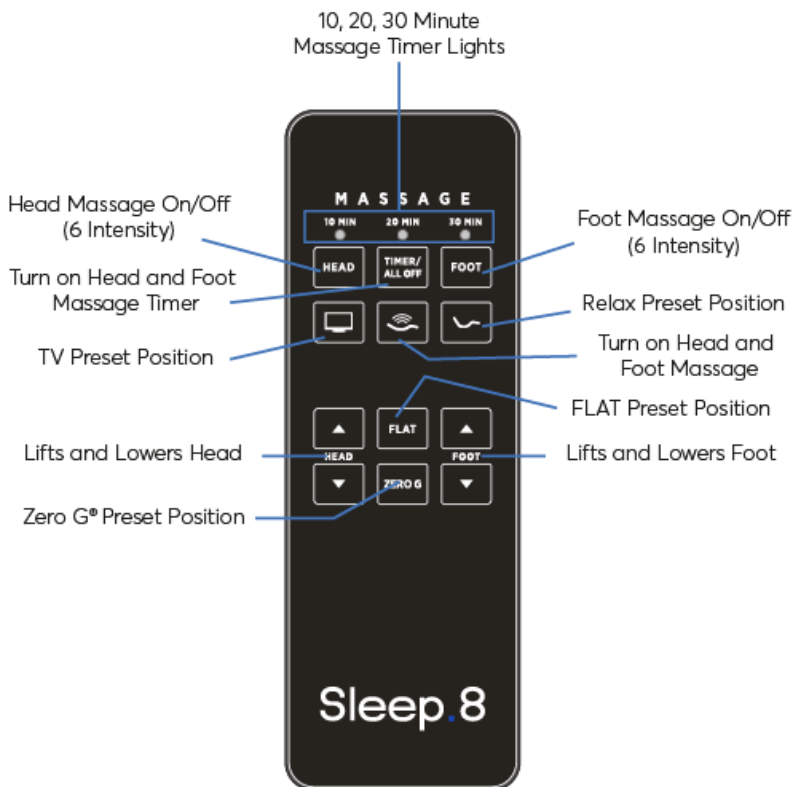

### ⚠ WARNING



- Be sure no one is near or under the bed when you lower it.
- Always engage Child Safety Lock on the remote before leaving bed.
- Store remote where children cannot reach it.
- Keep bed in flat position when not in use.

### ACTIVATE CHILD SAFETY LOCK



- Press and hold the **HEAD UP + FLAT** buttons together for three (3) seconds until the remote backlight flashes twice.
- The remote is now in **CHILD SAFETY LOCK**.
- Pressing any buttons while in Child Lock will yield no movement to your adjustable base.

### DEACTIVATE CHILD SAFETY LOCK



- Press and hold the **FOOT UP + FLAT** buttons together for three (3) seconds until the remote backlight flashes twice.
- The remote is no longer in **CHILD SAFETY LOCK**.
- The remote and adjustable base will work normally.

## Quick Reference Guide

**Not to scale. For illustration purposes only. Read all instructions before beginning installation.**

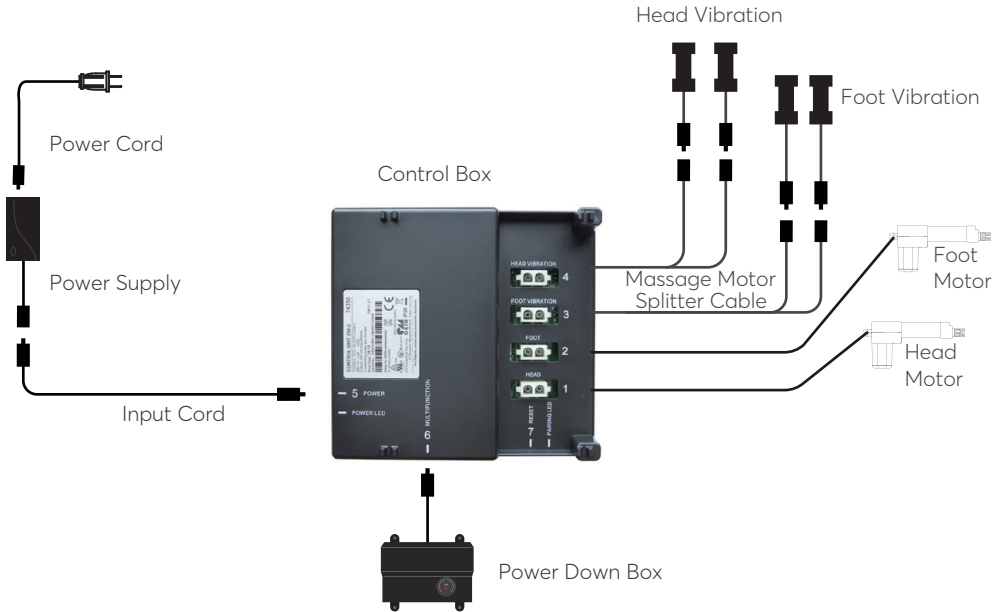

**If installing a split unit, see page 17.**

## Installation Guide

**Always use two people when setting up the base**

### STEP 1

Place the bed base box in a desired location with the top of the box facing up. Remove the binding straps and packing materials, making sure not to puncture the box with any sharp objects.

### STEP 2

Remove the bed base from the box keeping the bottom of the base facing upwards.

### STEP 3

**To install Headboard Brackets (sold separately) see instructions on page 19.**

To install the legs, thread the washer over the bolt of the leg with the recessed side facing the leg, and tighten by hand.

**Do not over tighten.**



### STEP 4

**To sync two bases see detailed installation instructions on page 17.**

Locate the Power Down Box and install (2) 9 Volt Alkaline Batteries (not included).

### STEP 5

Uncoil input Power Cord (connected to Control Box's power port) and plug into Power Supply.



## STEP 6

Uncoil the Power Cord and connect to the Power Supply. Place Power Supply on the ground and extend from the base. Ensure that the Power Supply and all attached cords are directed toward the desired surge protector.



## STEP 7

Carefully flip the base over on to its legs. Important: Two people are required to move the bed base. Do not drag across the floor. Do not rest frame on its side, excessive pressure may damage the legs.

## STEP 8

Plug the power cord into a power source.

**A surge protector is recommended.**



## STEP 9

Quickly test remote functions to verify proper setup before placing mattress on base. Return the base to a flat position before placing the mattress on top.

## STEP 10

Slide the left side of the mattress retainer bar into the bracket. Pull the retainer bar to the opposite bracket and secure the right side.



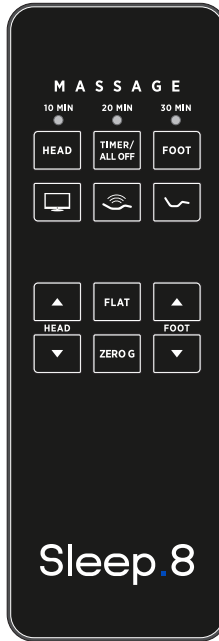

**Setup is now complete! Test all functions on remote.**

Remote Control arrives paired to the adjustable base. Three (3) AAA batteries are required to operate the remote.



## SAVE UP TO FAVORITE POSITION

To program:

Press and hold one of the buttons (  and  ) for at least 5 seconds. Position is now saved.

To restore the preset buttons back to their original factory settings: Hold FLAT and ZERO-G simultaneously for at least 5 seconds. The original presets will be restored.

## MESSAGE FEATURE



The **MESSAGE** button activates head and foot massage at levels 1, 3, 6 and then turns head and foot massage off.



The **HEAD** button will turn on the head massage. Cycle through 6 massage intensities.



The **FOOT** button will turn on the foot massage. Cycle through 6 massage intensities.



The **TIMER/ALL OFF** button Starts massage at level 3. Select a 10, 20 or 30 minute massage interval. Pressing a fourth time will turn off massage.

10 MIN

• The light on the top of the remote indicates a 10, 20 or 30 minute timer setting. Massage automatically shut off after 10 minutes if the massage timer isn't set.

## ADJUST



The **HEAD ▲▼** arrows lift and lower the head section of the base.



The **FOOT ▲▼** arrows lift and lower the foot section of the base.

## ONE TOUCH BUTTONS



One touch **ZERO G** preset position. Zero-G adjusts your legs to a higher level than your heart helping to relieve pressure off the lower back and promote circulation.



One touch **FLAT** preset position.



One touch **TV** preset position.



One touch **RELAX** preset position.

## Remote Control Pairing

### Remote Pairing

The original remote that comes in the box is already paired to the adjustable base. No further action is required. In the event that the remote is not paired with the base, follow the steps below.

### STEP 1

Locate the Power Down Box and press the button **TWICE**. A light on the Power Down Box will illuminate.

Power Down Button





## STEP 2

Remove the back cover of the remote, press and hold down the PAIR button. The PAIR button will illuminate blue and start flashing. When the PAIR button stops flashing, the illuminated light on the Power Down Box will go out. Release the PAIR button. The remote is now paired to the adjustable base.

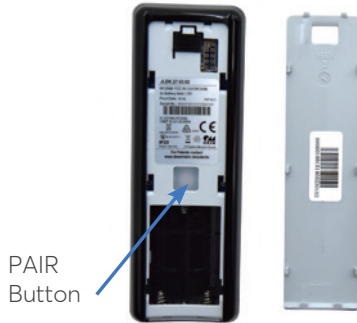

## STEP 3

Test all remote functions. If the remote buttons do not impact the adjustable base movements, please repeat the process again.

### \*ALTERNATE REMOTE PAIRING PROCESS!

Locate the Control Box (see base overview and quick reference guide for corresponding base) and press the Reset/Pairing button twice. A pairing LED light will illuminate green on the Control Box. On the back of the remote, press and hold the PAIR button. The PAIR button will illuminate blue and start flashing. When the PAIR button stops flashing, the green LED light on the Control Box will go out. Release the PAIR button. The remote is now paired to the adjustable base.

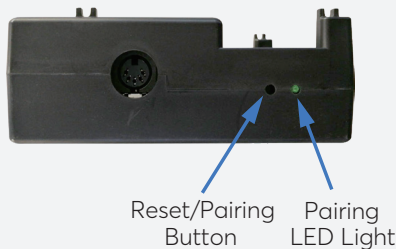

## Power Down Box

**Store the Power Down Box in a convenient location for emergency use. Two (2) 9 volt alkaline batteries are required to operate the power down feature and are NOT included.**

### OVERVIEW

For emergency use only, in case of a power outage. In the event that the base is stuck in an articulated position during a power outage, the Power Down Box will return the base to a FLAT position. Batteries are not to be used for normal operation of the base.



### STEP 1

Install the 9 volt alkaline batteries into the provided Power Down Box. Do not mix brand name batteries.

### STEP 2

Press the button on the Power Down Box to lower the base to FLAT position.

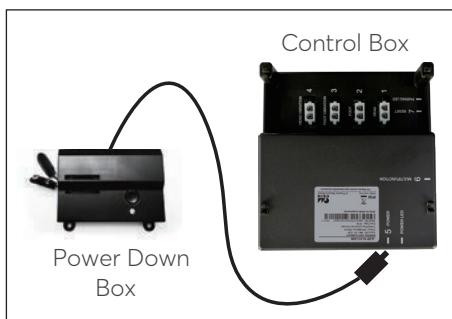

## Syncing Two Bases (Optional)

**A Sync Cord is included with the base. Not available on Queen, Full or Full-Long size bases. The Sync Cord connects the two control boxes to a single remote for the synchronization of two bases.**

### STEP 1

Unplug bases from power source.

### STEP 2

Disconnect the Power Down Box cable from each Control Box or splitter cable. Make note where the cable was plugged in.

### STEP 3

Connect the male end of each Sync Cord to Control Box or splitter cable. Insert it into the same port that you disconnected the Power Down Box from in Step 2.

### STEP 4

Connect each Power Down Box male connection to the sync cord female connection (refer to illustration at right).

### STEP 5

Plug bases back into the power source.

### STEP 6

Check to ensure all cords are securely attached. Both remotes will now operate both bases simultaneously.

**The system is now linked. Pressed buttons on either remote will control the two bases simultaneously.**

## PERFORMANCE NOTES

If bases become mismatched, pressing the FLAT button will re-sync the mechanical positions.

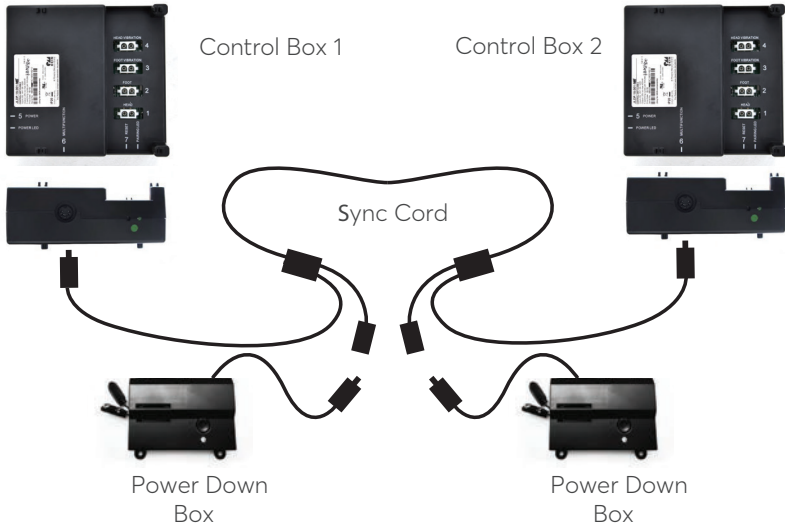

## Connecting Strap (Optional)

**If any split setup is being installed, plastic connecting straps are provided (one per base) to secure the bases together. Use both straps to secure the head and foot portions together.**

### STEP 1

With the bases in their desired location, slightly loosen both legs to allow the strap to fit on the leg bolt, between the leg washer and frame.



## STEP 2

Slide side (a) of the connecting strap onto leg bolt. Swing the strap and connect side (b) to the leg bolt. Secure the strap by shifting to the left.



## STEP 3

Re-tighten legs. **Do not over tighten.** Use the remaining strap on other end of the base. Secure the strap by shifting to the left.

## Headboard Bracket Installation Guide (Optional)

### Parts List

A

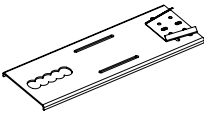

Headboard Bracket x2

B

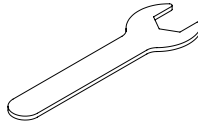

13 MM Outer hexagonal  
Simple Wrench x1

C

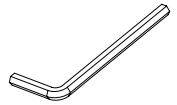

5 MM Hex Wrench x1

D

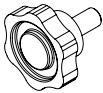

Flower Nut x4

E

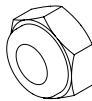

Nut x2

F

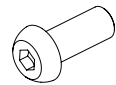

Screw x2

## STEP 1

Install the headboard bracket. Use a hexagon wrench and a simple wrench to fix the nuts and screws of the main board (Left-right symmetric installation).

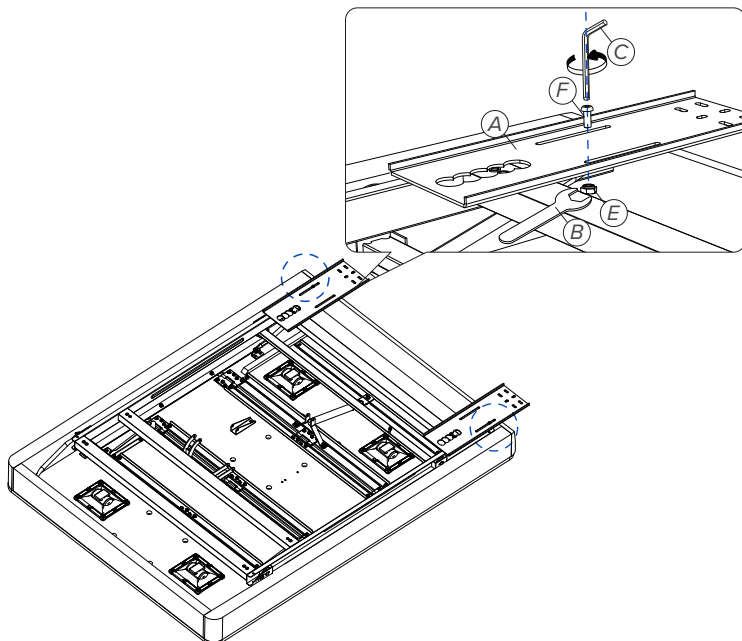

## STEP 2

Install all the legs. Make sure all legs are installed on the frame.

