

KWC CAMPUS Wall hung WC pan

Modell-Linie: **CAMPUS | CMPX592WN**
WCs and urinals | WCs

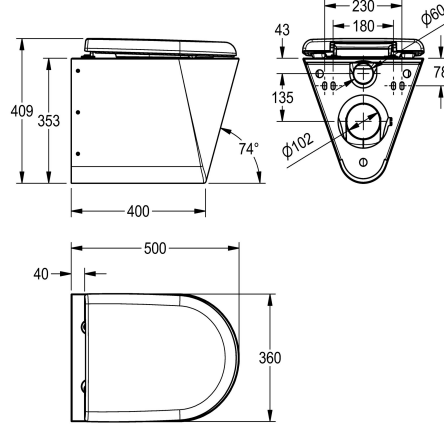

KWC-No.

2000100133
Without toilet seat

2000100134
With 2 toilet seat pads

360000629
With black toilet seat

360000650
With grey toilet seat

360000651
With white toilet seat

type of toilet seat

no seat

synthetic seat pad

synthetic hinged seat with lid

synthetic hinged seat with lid

synthetic hinged seat with lid

Wall hung WC pan, stainless steel, surface satin finished, material thickness 1.5 mm, flushing certificated to EN 997, concealed flushing rim with min. 4 liter flushing capacity, with a shrouded 100 mm diameter horizontal 'P' trap outlet, pressed seat area tapered towards centre, all edges curved, fixing with mounting plate

supplied, conform to EN 33, includes security screws. 4 litre flush EN997 approved.

With white WC-seat
Dimensions 360 x 409 x 500 mm (W x H x D)

Technical Data

inlet size
material
material code
material thickness
minimum flushing capacity
outlet size
overall depth
overall height
overall width
toilet seat colour
surface finish
type of mounting
type of toilet seat
type of WC

DN 55
stainless steel
1.4301 Chrome Nickel steel V2A
1.5 mm
4 Liter
DN 100
500 mm
409 mm
360 mm
white
satin finished
wall mounting
synthetic hinged seat with lid
wall hung

Spare Parts

KWC CAMPUS Wall hung WC pan

Modell-Linie: CAMPUS | CMPX592WN
WCs and urinals | WCs



Toilet seat

3600000624
ECMPX592-SEATGN



Toilet seat

3600000626
ECMPX592-SEATBN



Toilet seat

3600000627
ECMPX592-SEATWN

Hinge

3600000658
ECMPX0058N