

Biodrier. com

Hand Dryer User Manual

MODEL : EXECUTIVE BBE1000

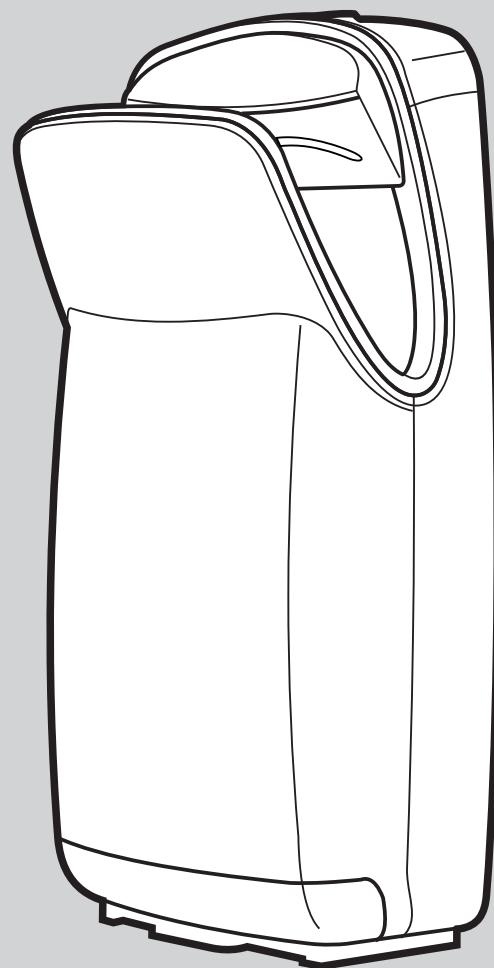

READ AND SAVE THESE INSTRUCTIONS

IMPORTANT SAFETY INSTRUCTIONS

WARNING - TO REDUCE THE RISK OF FIRE, ELECTRIC SHOCK, OR INJURY TO PERSONS OBSERVE THE FOLLOWING :

- Use this unit only in the manner intended by the manufacturer. Manufacturer is not responsible for damages caused by misuses or defective installations.
- The instructions contained within the installation Template enclosed must be followed carefully when installing this unit. Failure to accurately follow the instructions may result in the incorrect operation of this unit, damage to property and/or personal injury.
- Installation work and electrical wiring must be done by qualified person(s) in accordance with all applicable codes and standards, including fire-rated construction.
- When cutting or drilling into wall or ceiling, do not damage electrical wiring and other hidden utilities.
- This unit must be powered by a dedicated circuit branch protected by a circuit breaker with the appropriate rating. Circuit cable must be fit current consumption for this unit.
- This unit has been designed for indoor use only, covered from water, sun and extreme temperatures, do not use it outdoors or close to moisture and heat generators.
- This unit can only be revised, maintained, repaired and removed by qualified person(s). If the unit stops and works strangely, contact your regional dealer or contractor.
- This appliance is not intended for use by persons (including children) with reduced physical, sensory or mental capabilities, or lack of experience and knowledge, unless they have been given supervision or instruction concerning use of the appliance by a person responsible for their safety.

SAFETY PRECAUTIONS

WARNING - TO REDUCE THE RISK OF FIRE, ELECTRIC SHOCK, OR INJURY TO PERSONS OBSERVE THE FOLLOWING :

- Always use genuine pieces and spare parts.
- Do not use for purposes other than drying hands.
- Foreign objects must not be put neither in nor over the unit.
- Heavy objects must not be put over the unit.
- Do not use at locations where salt damage may occur or where corrosive are present.
- Do not operate in an explosive atmosphere.
- Do not use in locations with a great deal of humidity in the air or where condensation may form on the product.
- Children should be supervised to ensure that they do not play with the appliance.
- Installation of the appliance, appropriate details shall be given.
- The instructions for fixed appliances shall state how the appliance is to be fixed to its support.
- Household (indoor) use only, do not use.
- Do not immerse the appliance in water or other liquid.
- Unplug from outlet before cleaning and maintenance.
- This appliance can be used by children aged from 8 years and above and persons with reduced physical, sensory or mental capabilities or lack of experience and knowledge if they have been given supervision or instruction concerning use of the appliance in a safe way and understand the hazards involved. Children shall not play with the appliance. Cleaning and user maintenance.
- If the supply cord is damaged, it must be replaced by the manufacturer, its service agent or similarly qualified persons in order to avoid a hazard.



WARNING

This appliance must not be disposed together with the domestic waste. This appliance has to be disposed at an authorized place for recycling of electrical and electronic appliance. By collecting and recycling waste, you help save natural resources, and make sure the product is disposed in an environmental friendly and healthy way.

EUROPEAN DIRECTIVES

This unit complies with the following European Directives : GS, CE_LVD, CE_EMG

SPECIFICATIONS

Item	Specification
Voltage	AC 220~240V
Frequency	50/60Hz
Power consumption	1000W
Dimension	W330xD230xH670mm
Weight	About 9kg

INSTALLATION

A Type : Power cable not equipped

1. Secure the line and connect the power cable into the proper terminal block locations. Verify connections are correct before proceeding.

2. Cover the power connector with the provided housing cover (Power Supply Cover kit)

• Minimum wire cross section : 2x1mm²

B Type : Power cable equipped

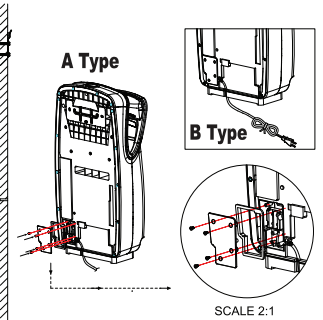

STANDARD ACCESSORIES



- Please make sure the following items are included with your hand dryer.
- If any items are missing, contact your regional dealer or contractor.

Notice

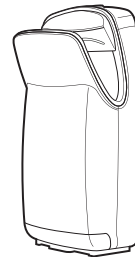

Hand Dryer



This unit includes the following standard accessories :

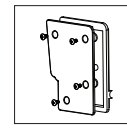

Power Supply Cover Kit

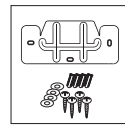

Wall Mount Kit

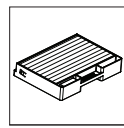

Filter Equipped



Cleaning Kit

HOW TO USE

- Insert your hands and the unit will start automatically.
- Slowly move your hands up and down through the air until your hands are dry.
- The unit automatically stops once the hands are removed and is ready for the next cycle.

Power Switch on / off
(factory default setting "ON")
Speed Control High/Low
(factory default setting "High")

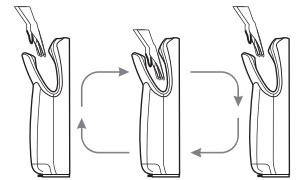
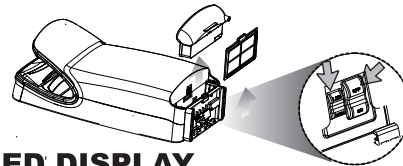

LED DISPLAY

Standby: Standby: the indicator light is OFF.

LED1: Starting operation: (Mode 1) LED 1 appears a blue icon "O" 3 times. Thereafter the LED lights rotate clockwise for 9 seconds, (one drying cycle) thereafter the 30 LED lights blink for 3 times. The LEDs rotate again and flash after 9 seconds. Thereafter the machine shuts off automatically. (Mode 2) Same as above but LED start to rotate clockwise for 10 seconds right away. If there is an electrical or motor problem occurs all 30 LED lights will blink for 30.

LED2: Filter change sign. The Filter sign will turn on after 25000 uses. After replacing the filter the filter sign will stay for 5 seconds, and then blink 3 times (the filter usage is reset).

LED3: Shows that the water tank is full. When full the water tank will blink red until the water is emptied and the tray is put back into the unit.

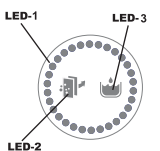

MAINTENANCE



- All surfaces of the unit should be cleaned daily with a soft cloth and a non-caustic cleaning solution
- The unit should only be in operation with filter and water.
- Regularly check filter condition and water tank status on the display panel.



Red blinking light

- Do not wash the filter with water. Clean the filter from dust and dirt once a week. The filter should be replaced after 25000 uses.
- When the unit reaches 25000 operations/cycles the red LED on the display panel will start blinking until the filter is cleaned or replaced with a new one.
- To purchase filters please contact your local supplier.
- WARNING: If the filter is not replaced on time or the airflow is blocked from heavy dust and dirt the motor can overheat and be damaged. In this case the warranty terms and conditions are not valid.

- When the water tank is full the water full sign is activated on the display panel.
- If the water tank is not emptied on time the water will overflow and create dirty and wet conditions in the washroom.
- Empty and clean the water tank before the Water Full lights on.
- If the water tank is not emptied and cleaned on a regular basis it can lead to bad smells due to the collection of bacteria.

Water Full

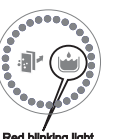

Red blinking light

WARRANTY

Warranty condition is according to the separate Warranty Card.