

## INSTRUCTION MANUAL

R.C. SYSTEMS CO. INC.

### MODEL ViewSmart 6400 (ViewSmart 6400) 16,32,48 or 64 CHANNEL CONTROLLER



**Warning: Read & understand contents of this manual prior to operation. Failure to do so could result in serious injury or death.**

PHONE: (409)986-9800 FAX: (409) 986-9880

8621 HWY 6 HITCHCOCK, TX 77563

Website: <http://www.rcsystemsco.com>

<b>SECTION 1 GENERAL DESCRIPTION.....</b>	<b>1</b>
1.1 IMPORTANT SAFETY ISSUES .....	1
1.2 GENERAL DESCRIPTION.....	2
1.3 DATA DISPLAY SCREENS.....	3
1.3.1 MAIN DATA SCREEN	3
1.3.2 24 HOUR TREND SCREEN	5
1.3.3 BAR GRAPHS SCREEN	7
1.3.4 COMBINATION SCREEN	8
1.3.5 ZONE SCREEN	9
1.4 SPECIFICATIONS .....	10
1.4.1 DC POWER SUPPLY REQUIREMENTS	10
1.4.1.1 600 WATT AC – 24VDC POWER SUPPLY	11
1.4.1.2 150 WATT AC – 24VDC POWER SUPPLY	11
1.4.1.3 RELAYS	11
1.4.2 AMBIENT TEMPERATURE RANGE	12
1.4.3 HUMIDITY RANGE	12
1.4.4 ALTITUDE	12
1.4.5 HOUSINGS	12
1.4.6 NON-INTRUSIVE MAGNETIC KEYPAD	12
1.4.7 APPROVALS	13
<b>SECTION 2 BASIC OPERATION .....</b>	<b>14</b>
2.1 MAIN MENU CONFIGURATION.....	14
2.2 CHANGING MENU VARIABLES USING THE KEYPAD .....	22
2.3 ALARM OUTPUTS .....	22
2.3.1 STANDARD RELAY 1, 2, AND 3	24
2.3.1.1 A1 A2 & A3 VOTES REQUIRED	24
2.3.1.2 ACKNOWLEDGE	24
2.3.1.3 FAILSAFE	25
2.3.1.4 ZONE 1-8	25
2.3.1.5 OVERRIDE CHANNELS 1-8	25
2.3.2 HORN/PIEZO	25
2.3.2.1 A1 A2 & A3	26
2.3.2.2 ACKNOWLEDGE	26
2.3.2.3 FAILSAFE	26
2.3.2.4 PIEZO ALARM	26
2.3.3 DISCRETE RELAY	26
2.3.4 PROGRAMMABLE RELAY	27
2.4 CHANNEL CONFIGURATION ENTRY MENU.....	27
2.4.1 CHANNEL CONFIGURATION MENUS	28
2.4.2 ALARM 1 / ALARM 2 / ALARM 3 MENU	28
2.4.2.1 SETPOINT	29
2.4.2.2 LATCHING	29
2.4.2.3 TRIP ON	29
2.4.2.4 ON/OFF DELAYS	29

2.4.2.5	HORN ON	29
2.4.2.6	COLOR	30
2.4.2.7	ENABLED	30
2.4.3	FAULT ALARM MENU	30
2.4.4	DATA FROM MENU TO SET INPUT SOURCE	30
2.4.4.1	SOURCE	31
2.4.4.2	MIN RAW & MAX RAW	31
2.4.4.3	FILTER SAMPLE COUNT	32
2.4.4.4	LOCAL CAL	32
2.4.4.5	MARKER MENU	33
2.4.4.6	REMOTE ID	34
2.4.4.7	ALIAS	34
2.4.4.8	INTERFACE	35
2.4.4.9	SLAVE BYTE ORDER	35
2.4.5	LINEARIZE	35
2.4.6	CONFIGURE MENU	35
2.4.6.1	INFO / MEASUREMENT NAME	36
2.4.6.2	ZERO / SPAN	36
2.4.6.3	DECIMAL POINTS	36
2.4.6.4	CHANNEL ON?	37
2.4.6.5	ZONE	37
2.4.6.6	DEADBAND	37
2.4.6.7	COPY TO CHANNEL	37
2.4.6.8	COPY TO GROUP	37
2.4.6.9	RESTORE CH. DEFAULTS	38
<b>2.5</b>	<b>COMMUNICATION SETTINGS MENU .....</b>	<b>38</b>
2.5.1	COM 1-4 SETTINGS	40
2.5.1.1	FUNCTION	40
2.5.1.2	BAUDRATE	41
2.5.1.3	PARITY	41
2.5.1.4	TIMEOUT	41
2.5.1.5	POLL DELAY	41
2.5.1.6	SYMPATHY ENABLED	41
2.5.1.7	RADIO SETUP	42
2.5.1.8	SLAVE BYTE ORDER	42
2.5.1.9	WIRELESS TIMEOUT	42
2.5.2	MODBUS TCP SETTINGS	43
2.5.2.1	SLAVE BYTE ORDER	43
2.5.2.2	MASTER TIMEOUT	43
2.5.2.3	MASTER POLL DELAY	43
2.5.3	NETWORK SETTINGS	44
2.5.3.1	DHCP ENABLED	44
2.5.3.2	HOSTNAME	44
2.5.3.3	IP ADDRESS	44

2.5.3.4	NETMASK	44
2.5.3.5	GATEWAY	44
2.5.4	TROUBLESHOOTING	45
2.5.4.1	VIEW COMM FAILURES	46
2.5.4.2	CLEAR FAILURE COUNTS	47
<b>2.6</b>	<b>SECURITY MENU</b> .....	<b>47</b>
2.6.1	USER NAME	47
2.6.2	LOCK CODE	47
2.6.3	MODBUS LOCK CODE	47
<b>2.7</b>	<b>SYSTEM MENU</b> .....	<b>48</b>
2.7.1	VERSION	50
2.7.2	CONFIGURE	50
2.7.2.1	NAME	51
2.7.2.2	CONTRAST	51
2.7.2.3	DATE & TIME	51
2.7.2.4	ENABLE CHANNEL COUNT	51
2.7.2.5	DISPLAY ALARM	51
2.7.2.6	WARMUP & CAL PURGE TIME	51
2.7.2.7	ZONE SCREEN ENABLED	51
2.7.2.8	BLOCK NEGATIVE	51
2.7.2.9	RELAY REFRESH	51
2.7.3	ZONE NAMES	52
2.7.4	MIMIC MODE	52
2.7.5	SD CARD	53
2.7.5.1	CARD STATUS	54
2.7.5.2	LOGGER ENABLED	54
2.7.5.3	SAVE CONFIGURATION FILE	54
2.7.5.4	LOAD CONFIGURATION FILE	54
2.7.5.5	VIEW LOG FILE TREND	55
2.7.6	VIEW EVENT LOG	56
2.7.7	CLEAR EVENT LOG	57
2.7.8	VIEW SENSOR LIFE	57
<b>SECTION 3</b>	<b>INPUT/OUTPUT BOARDS</b> .....	<b>58</b>
<b>3.1</b>	<b>MAIN I/O INTERFACE BOARD # 10-0331</b> .....	<b>58</b>
<b>3.2</b>	<b>INPUT / OUTPUT OPTION BOARDS</b> .....	<b>59</b>
3.2.1	OPTIONAL ANALOG INPUT BOARD # 10-0334	60
3.2.2	OPTIONAL DISCRETE RELAY BOARD # 10-0345	62
3.2.3	OPTIONAL *BRIDGE SENSOR INPUT BOARD #10-0347	63
3.2.4	BRIDGE SENSOR INPUT BOARD INITIAL SETUP	64
3.2.5	OPTIONAL 4-20mA ANALOG OUTPUT BOARD #10-0348	65
3.2.6	OPTIONAL PROGRAMMABLE RELAY BOARD # 10-0350	66
3.2.7	OPTIONAL 24VDC 600 WATT POWER SUPPLY	69
3.2.8	OPTIONAL 24VDC 150 WATT POWER SUPPLY #10-0172	69
3.2.9	OPTIONAL 24VDC 150 WATT POWER SUPPLY #10-0673	71

<b>SECTION 4</b>	<b>DIAGNOSTICS</b> .....	<b>72</b>
4.1	STANDARD RELAYS.....	72
4.2	DISCRETE RELAYS.....	73
4.3	PROGRAMMABLE RELAYS.....	73
4.4	ANALOG INPUTS.....	74
4.4.1	VIEW INPUTS	74
4.4.2	CALIBRATE BOARD	74
4.5	ANALOG OUTPUTS.....	75
4.6	PIEZO .....	75
4.7	LEDS .....	76
4.8	SERIAL PORTS.....	76
4.9	I/O BOARD CONFIGURATION.....	77
<b>SECTION 5</b>	<b>MODBUS</b> .....	<b>79</b>
5.1	MODBUS TCP .....	79
5.2	MODBUS SLAVE WRITES.....	79
5.3	MODBUS SLAVE REGISTER LOCATION .....	79
5.3.1	COILS	80
5.3.2	DISCRETE INPUTS	80
5.3.3	INPUT REGISTERS	83
5.3.4	HOLDING REGISTERS	87
5.3.5	STANDARD RELAY 1	88
5.3.6	STANDARD RELAY 2	91
5.3.7	STANDARD RELAY 3	94
5.3.8	DISCRETE RELAYS	96
5.3.9	HORN/PIEZO	97
5.3.10	CHANNEL CONFIGURATION	98
5.3.11	PROGRAMMABLE RELAYS	101
<b>SECTION 6</b>	<b>ENCLOSURE OPTIONS</b> .....	<b>106</b>
6.1	ViewSmart 6400PM PANEL / RACK MOUNT ENCLOSURE.....	106
6.2	ViewSmart 6400N4 NEMA 4X LARGE WALL MOUNT FIBERGLASS ENCLOSURE.....	107
6.3	ViewSmart 6400CP NEMA 4X COMPACT WALL MOUNT FIBERGLASS ENCLOSURE.....	108
6.4	ViewSmart 6400XP NEMA 7 WALL MOUNT ALUMINUM ENCLOSURE.....	111
6.5	ViewSmart 6400 MAIN I/O & OPTION PCB FOOTPRINT DIMENSIONS AND ENCLOSURE CAPACITIES .....	112
<b>SECTION 7</b>	<b>WIRELESS OPTION</b> .....	<b>114</b>
7.1	RADIO SETUP MENU .....	115
7.1.1	HOP CHANNEL	116
7.1.2	SYSTEM ID	116
7.1.3	MODE	116
7.2	WIRELESS MONITOR MODE .....	116
7.2.1	RADIO STATUS ALARMS - WIRELESS MONITOR MODE	117
7.2.1.1	COMMUNICATIONS ERROR	117
7.2.1.2	LOW BATTERY	118

7.2.1.3	CALIBRATIONS	118
<b>7.3</b>	<b>WIRELESS MODBUS SLAVE MODE</b>	<b>118</b>
<b>7.4</b>	<b>WIRELESS MODBUS MASTER MODE</b>	<b>118</b>
<b>7.5</b>	<b>ANTENNA SELECTION</b>	<b>119</b>
7.5.1	DIPOLE AND COLLINEAR ANTENNAS	119
7.5.2	YAGI ANTENNAS	119
7.5.3	MOUNTING NEAR OTHER ANTENNAS	120
7.5.4	COAX CABLES	120
<b>7.6</b>	<b>SURGE PROTECTION &amp; GROUNDING</b>	<b>121</b>
7.6.1	ANTENNA GROUNDING	121
<b>SECTION 8</b>	<b>WEBPAGE</b>	<b>123</b>
<b>8.1</b>	<b>SYSTEM SCREEN</b>	<b>123</b>
<b>8.2</b>	<b>ZONE SCREEN</b>	<b>125</b>
<b>8.3</b>	<b>CHANNEL SCREEN</b>	<b>126</b>
<b>8.4</b>	<b>EVENT LOG SCREEN</b>	<b>127</b>
<b>8.5</b>	<b>CONFIGURE</b>	<b>127</b>
8.5.1	ALARM OUTPUTS	128
8.5.2	CHANNEL CONFIGURATION	129
8.5.3	COPY CHANNELS	130
8.5.4	PROGRAMMABLE RELAYS	131
8.5.5	SYSTEM CONFIGURATION	132
8.5.6	Email Configuration	133
8.5.6.1	Email Capabilities	133
8.5.6.2	Email Server Setup	135
8.5.7	Email Setup	135
8.5.8	CONFIGURATION UPLOAD/DOWNLOAD	136
<b>SECTION 9</b>	<b>TROUBLESHOOTING</b>	<b>137</b>
<b>9.1</b>	<b>CHANNEL ERRORS</b>	<b>137</b>
9.1.1	COMM ERROR	137
9.1.2	CONFIG ERROR	137
9.1.3	I/O ERROR	137
<b>9.2</b>	<b>RESET TO FACTORY DEFAULTS</b>	<b>137</b>
<b>SECTION 10</b>	<b>NETWORK CONNECTION</b>	<b>139</b>
<b>10.1</b>	<b>DIRECT CONNECTION WITH CROSSOVER CABLE OR HUB/SWITCH</b>	<b>139</b>
<b>10.2</b>	<b>CONNECTING THE ViewSmart 6400 TO AN EXISTING LAN</b>	<b>140</b>
<b>10.3</b>	<b>CONNECTING THE ViewSmart 6400 ON AN ISOLATED NETWORK</b>	<b>141</b>
<b>10.4</b>	<b>STATIC IP CONFIGURATION</b>	<b>142</b>
10.4.1	ViewSmart 6400 STATIC IP CONFIGURATION	142
10.4.2	WINDOWS XP STATIC IP CONFIGURATION	143
10.4.3	DYNAMIC IP CONFIGURATION	145
<b>10.5</b>	<b>TESTING CONNECTIONS</b>	<b>146</b>

## SECTION 1 GENERAL DESCRIPTION

### 1.1 IMPORTANT SAFETY ISSUES

The following symbols are used in this manual to alert the user of important instrument operating issues:



This symbol is intended to alert the user to the presence of important operating and maintenance (servicing) instructions.



This symbol is intended to alert the user to the presence of dangerous voltage within the instrument enclosure that may be sufficient magnitude to constitute a risk of electric shock.

#### WARNINGS:



- **Shock Hazard** - Disconnect or turn off power before servicing this instrument.
- **WARNING- EXPLOSION HAZARD-** DO NOT REPLACE FUSE UNLESS POWER HAS BEEN SWITCHED OFF OR THE AREA IS KNOWN TO BE NON-HAZARDOUS.
- **WARNING- EXPLOSION HAZARD-** DO NOT DISCONNECT EQUIPMENT UNLESS POWER HAS BEEN SWITCHED OFF OR THE AREA IS KNOWN TO BE NON-HAZARDOUS.
- Use a properly rated CERTIFIED AC power (mains) cable installed as per local or national codes
- A certified AC power (mains) disconnect or circuit breaker should be mounted near the controller and installed following applicable local and national codes. If a switch is used instead of a circuit breaker, a properly rate CERTIFIED fuse or current limiter is required to be installed as per local or national codes. Markings for positions of the switch or breaker should state (I) for on and (O) for off.
- Clean only with a damp cloth without solvents.
- Equipment not used as prescribed within this manual may impair overall safety.

## 1.2 GENERAL DESCRIPTION

The R. C. Systems Co. Inc. ViewSmart 6400 64 channel Controller is designed to display and control alarm event switching for up to 64 sensor data points. It may also be set as a 16, 32 or 48 channel controller for applications needing fewer inputs. Three programmable standard alarms with features such as *ON* and *OFF* delays, *Alarm Acknowledge*, along with dedicated horn and fault relays make the ViewSmart 6400 well suited for many multi-point monitoring applications. Data may be input to the ViewSmart 6400 by optional analog inputs or via the multiple communication ports. These communication ports are programmable so the controller can be configured with multiple Master or Slave configurations. With a Modbus RTU *slave* RS-485 port configured, sending data to PCs, PLCs, DCSs, or even other ViewSmart 6400 Controllers is available. The Ethernet port allows the unit to be a ModbusTCP *Master and Slave* and also provides access to the embedded webpage. Options such as analog I/O and discrete relays for each alarm are easily added to the addressable I<sup>2</sup>C bus. Option boards have 16 channels and therefore require multiple boards for 64 channel applications.

In addition to traditional analog and serial methods of providing monitored values, the ViewSmart 6400 is also capable of sending and receiving wireless data.

A color 320 x 240 pixel graphic LCD readout displays monitored data as bar graphs, trends and engineering units. System configuration is through user friendly menus or via the internal webpage that can be accessed through the Ethernet connection built into the main I/O Board. All configuration data is retained in non-volatile memory during power interruptions and can also be backed up and loaded using the SD card located to the left of the display. The ViewSmart 6400 front panel is shown below in Figure1-1 displaying the Combination screen. Additional data screens are shown in section 1.



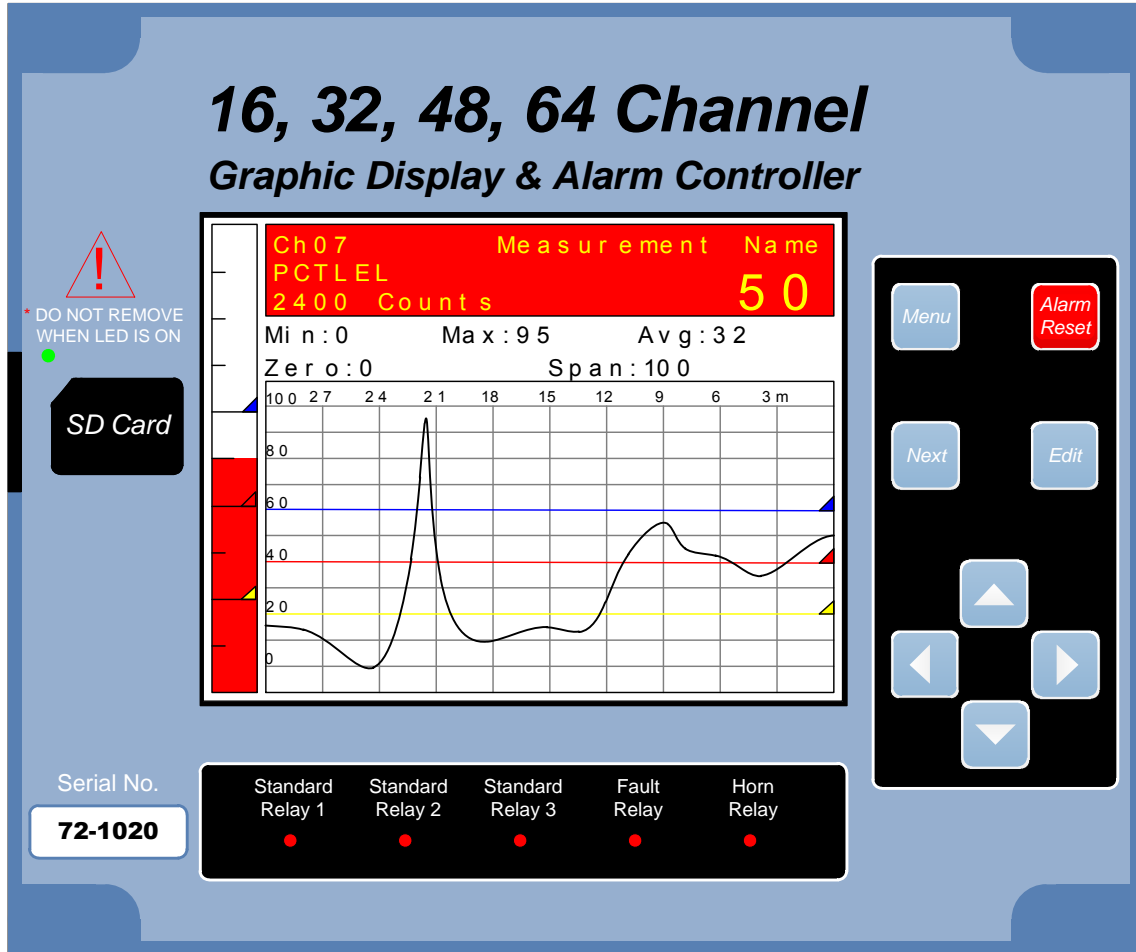



Figure1-1

### 1.3 DATA DISPLAY SCREENS

The ViewSmart 6400 Controller offers five distinct graphic displays for depicting the monitored data. These are Main Data, 24 Hour Trend, Bar Graphs, Zone and

Combination Screens. Pressing  from any of these display screens will bring you to

the Main Menu. Pressing  from the Main Data, 24 Hour Trend or Combination Screens will skip the Main Menu and bring you directly to the Channel Configuration Menu for the channel that is selected.

#### 1.3.1 MAIN DATA SCREEN

The ViewSmart 6400 Main Data screen shown below (Figure1-1) displays all active channels at once. It is capable of displaying 16, 32, 48 or 64 channels depending on the controller's configuration. This screen displays measurement name and uses a bar graph and colored cells that flash with new alarms to indicate alarm conditions. Once

the alarms have been acknowledged by an operator the cell will remain the appropriate color but will stop flashing, showing the alarm has been acknowledged. Utilizing the Display Alarm feature in the Systems Configuration menu allows new alarms to always force the LCD to the Main Data screen. This is useful for applications requiring channels with new alarms to be displayed.

While in the Main Data screen, use / / / to highlight any cell and press to go directly to that channel's configuration menu or press twice to scroll through that channel's individual data screens. The exploded channel 38 in the example below (Figure 1-2) indicates it is the channel selected and unused channels are grayed out when turned off.

Measurement	% Oxygen	Measurement	% Oxygen
Measurement	Measurement	Measurement	Measurement
Measurement	Measurement	Measurement	Measurement
Measurement	ppm H2S	Measurement	Measurement
Measurement	Measurement	Measurement	Measurement
Measurement	Measurement	46 PCTLEL	38
Measurement	Measurement	Measurement Name	Measurement
Measurement	Measurement	Measurement	Measurement
Measurement	Measurement	Measurement	Measurement
Measurement	Measurement	Measurement	% Oxygen
Measurement	Measurement	Measurement	% Oxygen
Measurement	Ppm H2S	% Oxygen	Measurement
Measurement	Measurement	Measurement	Measurement
Measurement	% Oxygen	Measurement	Measurement
Measurement	Measurement	Measurement	Measurement
Measurement	Measurement	Measurement	Measurement
Measurement	Ch. 32 off	Ch. 48 off	Measurement

Figure 1-2  
Main Data Screen (64 Ch. Mode)

### 1.3.2 24 HOUR TREND SCREEN

The ViewSmart 6400 24 Hour Trend screen shown in Figure 1-3 displays a 24 hour trend of input data for the channel selected. Vertical tic marks are each hour and horizontal tic marks are each 10% of full scale. Colored lines indicate alarm levels. The alarm level lines have triangles on the right end that indicate high and low trip for each alarm level. A triangle that points up represents a high trip alarm and one that points down represents a low trip alarm. Since each data point must be collected for several minutes before it may be displayed, it is likely input values will fluctuate during this interval. Therefore, MAX, MIN and AVERAGE values are stored in RAM memory for each subinterval. To accurately portray the trend, a vertical line is drawn between MIN & MAX values for each subinterval. The AVERAGE value pixel is then left blank, leaving a gap in the vertical line. This is demonstrated in the *noisy* area of the 24 hour trend in Figure 1-3. If the MAX & MIN values are within 2% of each other there is no need for the vertical line and only the AVERAGE value pixel is darkened as in the *quiet* areas. If there is no trend data available, the corresponding section of the graph will be grayed out. This will occur on power interruptions.

The top portion of each trend screen indicates channel number, real time reading in engineering units, measurement name, range, and MIN, MAX & AVERAGE values for the preceding 24 hour period. When a channel reaches alarm state, the colored bar

changes to the color that represents that alarm level and flashes. Once the alarm is acknowledged the bar stops flashing.

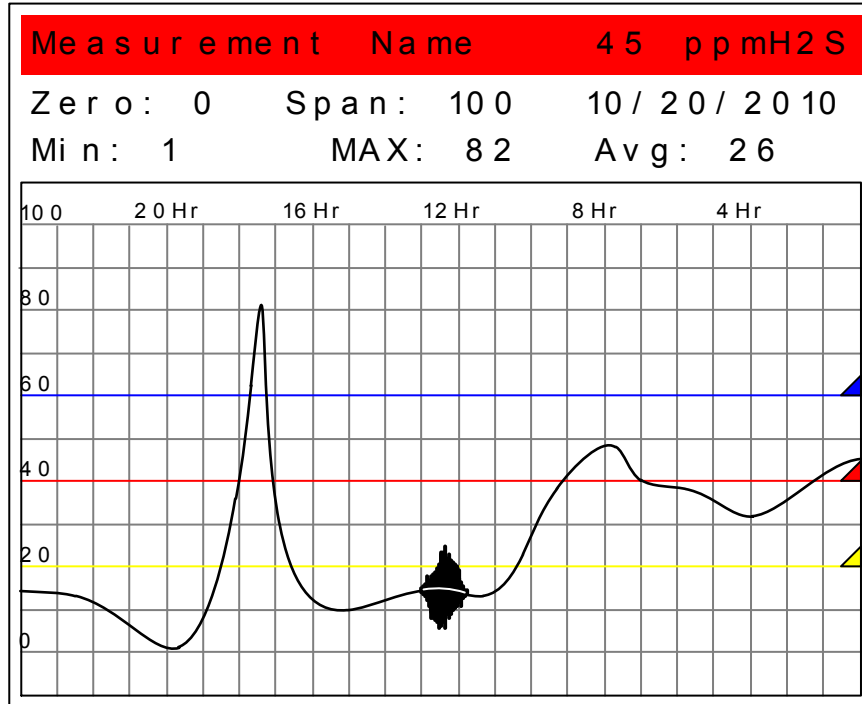

Figure 1-3  
24 Hour Trend Screen

### 1.3.3 BAR GRAPHS SCREEN

The ViewSmart 6400 Bar Graphs screen shown in Figure 1-4 allows 16 channels to be viewed simultaneously. Both engineering units and bar graph values are indicated in real time. Lines across the bars indicate the alarm trip points making it easy to identify channels near alarm. The bar graph alarm lines have colored triangles on the bottom that indicate alarm level and high or low trip for each alarm. A triangle that points right represents a high trip alarm and one that points left represents a low trip alarm. When a channel reaches alarm state, the bar graph changes to the color that represents that alarm level and flashes. Once the alarm is acknowledged the bar stops flashing. If there are more than 16 channels active the scroll bar along the right side of the screen indicates channels not in the viewing area. If one of the channels not in the viewing area goes into alarm the scroll bar arrow flashes the corresponding color of the alarm indicating which direction the user must scroll to display it. This is demonstrated by the top scroll bar arrow below.

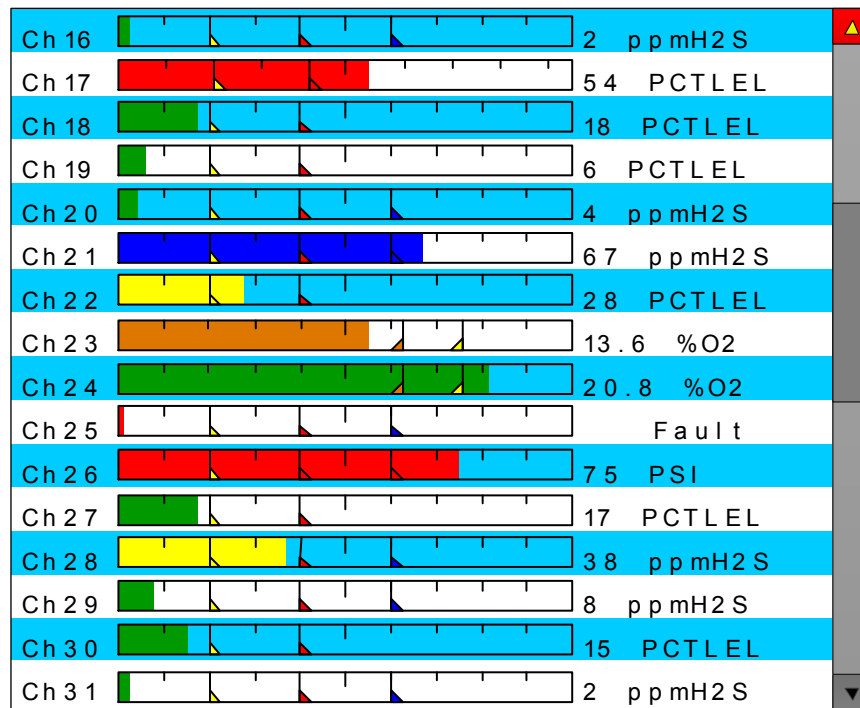

Figure 1-4

Bar Graphs Screen

### 1.3.4 COMBINATION SCREEN

The ViewSmart 6400 Combination screen shown in Figure 1-5 offers a view of a single channel but displays the data as a 30 minute trend, bar graph and large engineering units. The bar graph and the background color changes and flashes indicating alarm condition. Once the alarm is acknowledged they stop flashing. Colored lines across the bar graph and 30 minute trend indicate alarm levels. The alarm level lines have triangles on the right end that indicate high and low trip for each alarm level. A triangle that points up represents a high trip alarm and one that points down represents a low trip alarm. The Combination Screen is also useful for testing inputs for stability since MAX, MIN & AVERAGE values reset each time this screen is selected. For example, to test stability over a one hour period for an input, begin timing as soon as the channel is selected. One hour later record the MAX, MIN & AVERAGE values. The visible trend is only 30 minutes, but the difference between MAX & MIN indicates peak to peak excursions over the one hour period and AVERAGE is the average for the hour. Longer or shorter tests may also be run. A blue vertical line is drawn on the screen when the screen is selected and moves to the left indicating how long this screen has been active. The example below (Figure 1-5) has been active for 26 minutes.

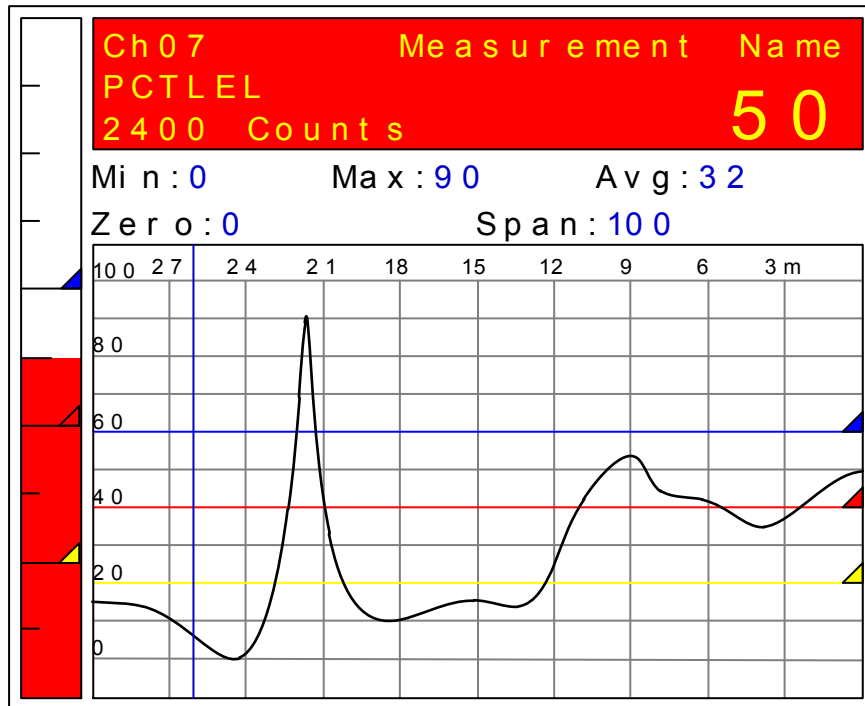

Figure 1-5  
Combination Screen

### 1.3.5 ZONE SCREEN

The ViewSmart 6400 Zone screen displays the eight possible zones simultaneously. If an alarm condition occurs the user will be able to quickly see in what zone the situation is occurring. Each active zone is divided into alarm levels which are green until an alarm is present. Inactive zones and alarm levels are grayed out. If an alarm should occur, the zone name field will flash and the corresponding box in the assigned zone will turn the color of the alarm that is present or alternate if two different colors are present. Once the alarm has been acknowledged the name field will stop flashing. Utilizing the Display Alarm feature in the Systems Configuration menu allows new alarms to always force the LCD to the Zone screen. This is useful for applications requiring zones with alarms to be displayed. If the Zone feature is not utilized this screen can be turned off in the Systems Menu.

The Zone screen is also helpful for configuring the different zones. To display all the

channels included in any zone, press  while in the Zone screen. This will cause a

blue box to outline one of the zones. Use  /  /  /  to select the correct

zone and press  again. The Main Data screen will appear with all the channels that are included in the selected zone displayed in color and the channels that are not in the

selected zone grayed out. Any channel needed to be included or excluded from the selected zone can be selected and configured from this screen.

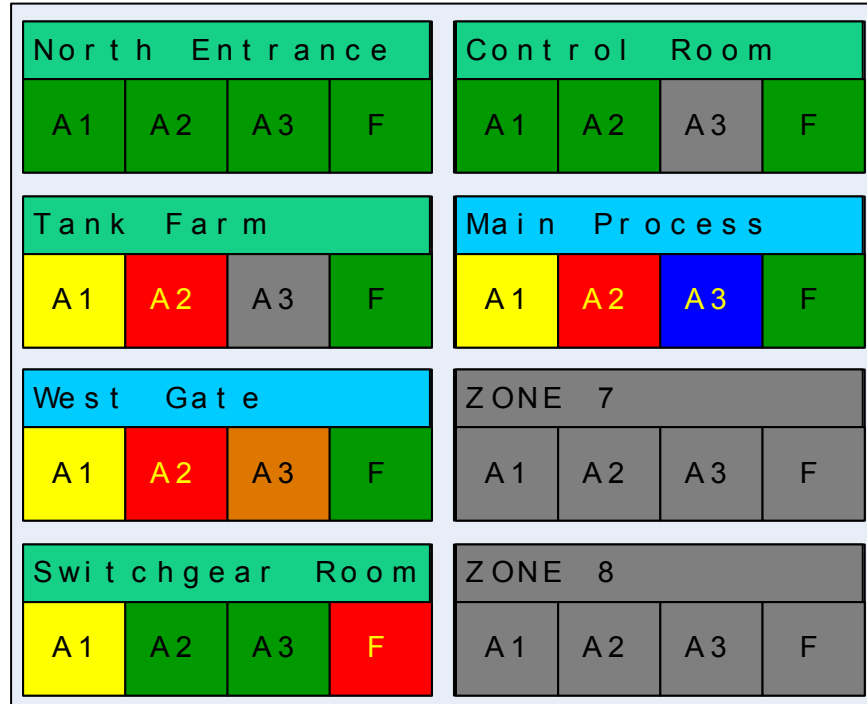

Figure 1-6

Zone Screen

## 1.4 SPECIFICATIONS

### 1.4.1 DC POWER SUPPLY REQUIREMENTS

Standard ViewSmart 6400 power requirements are 10-30VDC @ 12 watts applied to terminals 1 & 3(+) and 5 & 7(-) of TB4 on the standard I/O Board ([see section 3.0](#)).

Optional features increase power consumption as described below:

- Discrete Relay Board option; add 6.5 watts per board (assumes all 16 relays are energized).
- Programmable Relay Board option; add 6.5 watts per board (assumes all 16 relays are energized).
- Analog Input Board option; add 1/2 watts per board plus transmitter power consumption.
- 4-20mA Output Board option; add 2.5 watts per board.



- Bridge Sensor Input Board option; add 3 watts max per board with eight 10-0192 modules installed (power consumption of the sensors not included).
- Auxiliary Standard Relay Board option; add 2.5 watts.
- Isolated Serial Expansion Board; add 1.5 watts.
- TB4 terminals 2, 4, 6 & 8 of the standard I/O Board provide a maximum of 500mA fused output power for powering of auxiliary external devices such as relays, lamps or transmitters. Power consumed from these terminals should be considered when calculating system power consumption.

#### **1.4.1.1 600 WATT AC – 24VDC POWER SUPPLY**

\*110-120 VAC @8.5A max

\*220-240VAC @ 5A max

\* Universal AC input automatically selects AC input range.

The 600 watt power supply (Figure 3-7) is for powering the ViewSmart 6400 and up to 64 detectors. This power supply can be paralleled with up to three additional 600 watt power supplies providing up to 2400 watts for applications with large power requirements. It also features a built in DC-OK signal and remote on-off control.

#### **1.4.1.2 150 WATT AC – 24VDC POWER SUPPLY**

##### **1.4.1.2.1 10-0172 150W Power Supply**

\*110-120 VAC @3.2A max

\*220-240VAC @ 1.6A max

\* A slide switch on the front of the power supply selects AC input range.

The 10-0172 150 watt power supply (Figure 3-7) is for powering the ViewSmart 6400 and up to 64 detectors.

##### **1.4.1.2.2 10-0673 150W Power Supply**

100-240V~, 50/60Hz, 1.1A Auto switching power supply

Note: When equipped with 10-0673 power supply, the current consumption of the external devices powered by the equipment at 24V dc shall not exceed 2A

#### **1.4.1.3 RELAYS**

The ViewSmart 6400 comes standard with five Standard SPDT 5A relays, consisting of one dedicated HORN and one dedicated FAULT relay plus 3 programmable alarm relays. Programmable relays provide voting logic for ALARM 1, ALARM 2, and ALARM 3. Discrete relays and additional Programmable relays are optional. All relays are rated at 5 Amp for 28 VDC and 250 ~VAC RESISTIVE loads.



**IMPORTANT:** Appropriate diode (DC loads) or MOV (AC loads) snubber devices must be installed with inductive loads to prevent RFI noise spikes. Relay wiring should be kept separate from low level signal wiring.

### 1.4.2 AMBIENT TEMPERATURE RANGE

-25 to 60 degrees C

### 1.4.3 HUMIDITY RANGE

0 TO 90% R. H. Non-Condensing.

### 1.4.4 ALTITUDE

Recommended up to 2000 meters

### 1.4.5 HOUSINGS

\*General purpose panel mount weighing 7 lbs and including hardware for 19" rack mounting (

- Figure 6-1).

\*NEMA 4X wall mount in fiberglass enclosure weighing 54 lbs (

- Figure 6-2).

\*Includes non-intrusive magnetic keypad.

### 1.4.6 NON-INTRUSIVE MAGNETIC KEYPAD

The ViewSmart 6400 operator interface includes eight front panel *touch* keys



. A magnetic keypad option offers these eight keys with adjacent magnetic keys. This option is included as a standard feature. It is useful in applications where it may be inconvenient to open the enclosure's door to access the *touch* keypad.

## 1.4.7 APPROVALS

C22.2 No. 142-M1987 - Process Control Equipment

CAN/CSA-C22.2 No.152-M1984 - Combustible Gas Detection Instruments

ANSI/ISA-12.13.01-2000 - Performance Requirements for Combustible Gas Detectors

CSA-C22.2 No. 213-M1987- Non-Incendive Electrical Equipment for Use in Class I, Division 2 Hazardous Locations

UL Std No. 1604, Third Ed. - 1994 - Electrical Equipment for Use in Class I and II, Division 2; Class III Hazardous (Classified) Locations

ANSI/ISA-12.12.01-2010 - Non-Incendive Electrical Equipment for Use in Class I and II, Division 2 and Class III, Divisions 1 and 2 Hazardous (Classified) Locations



CSA File # = 219995 and may be seen at: [CSA-International.org](http://CSA-International.org).

### Notes:

- 1) The equipment is intended to be connected to supply mains with a suitable conduit according to the applicable local and national (CEC & NEC) regulations. Power supply cord and its entry inside the enclosure was not part of the investigation.
- 2) The suitability of the combination for rack mounting must be determined during the end usage.
- 3) Performance verified using Analog input board #10-0334 or Analog input PCB # 10-0158, 4-20mA input and configured in LEL mode.
- 4) When equipped with 10-0673 power supply, the current consumption of the external devices powered by the equipment at 24V dc shall not exceed 2A



## SECTION 2 BASIC OPERATION



The ViewSmart 6400 offers 5 graphic screens for viewing monitored data and several *Set-Up* menu screens for operator interface to configuration menus. The *Main Data* screen allows viewing of all active channels simultaneously. The *Trend* screen displays a 24 hour trend one channel at a time. The *Combination* screen displays a bar graph, large engineering units and a 30 minute trend one channel at a time. The *Zone* screen displays the eight possible zones simultaneously. Input channels may be displayed in

sequence from the *Trend* and *Combination* screens with  / .  switches between the 5 graphic data screens. When ViewSmart 6400 power is applied, the graphic LCD starts in the *Main Data* screen.

### 2.1 MAIN MENU CONFIGURATION

Variables inside *Main* menu tree allow optimum ViewSmart 6400 configuration for a wide range of demanding multi-point monitoring applications. The main menu is

entered by pressing . *Channel configuration* menus are entered by pressing .

from any channel's data screens, and scrolling to the desired menu using  / .

Pressing  again enters the selected menu's tree of variables. This *Setup* mode may

be exited manually by pressing  or automatically when no keys are pressed for 5 minutes. Alarm relays and front panel alarm LED indicators remain active during the *Setup* mode. A Security menu offers a password feature to prevent tampering with ViewSmart 6400 parameters. See Figure 2-1 – Figure 2-7 for a complete ViewSmart 6400 menu tree layout.

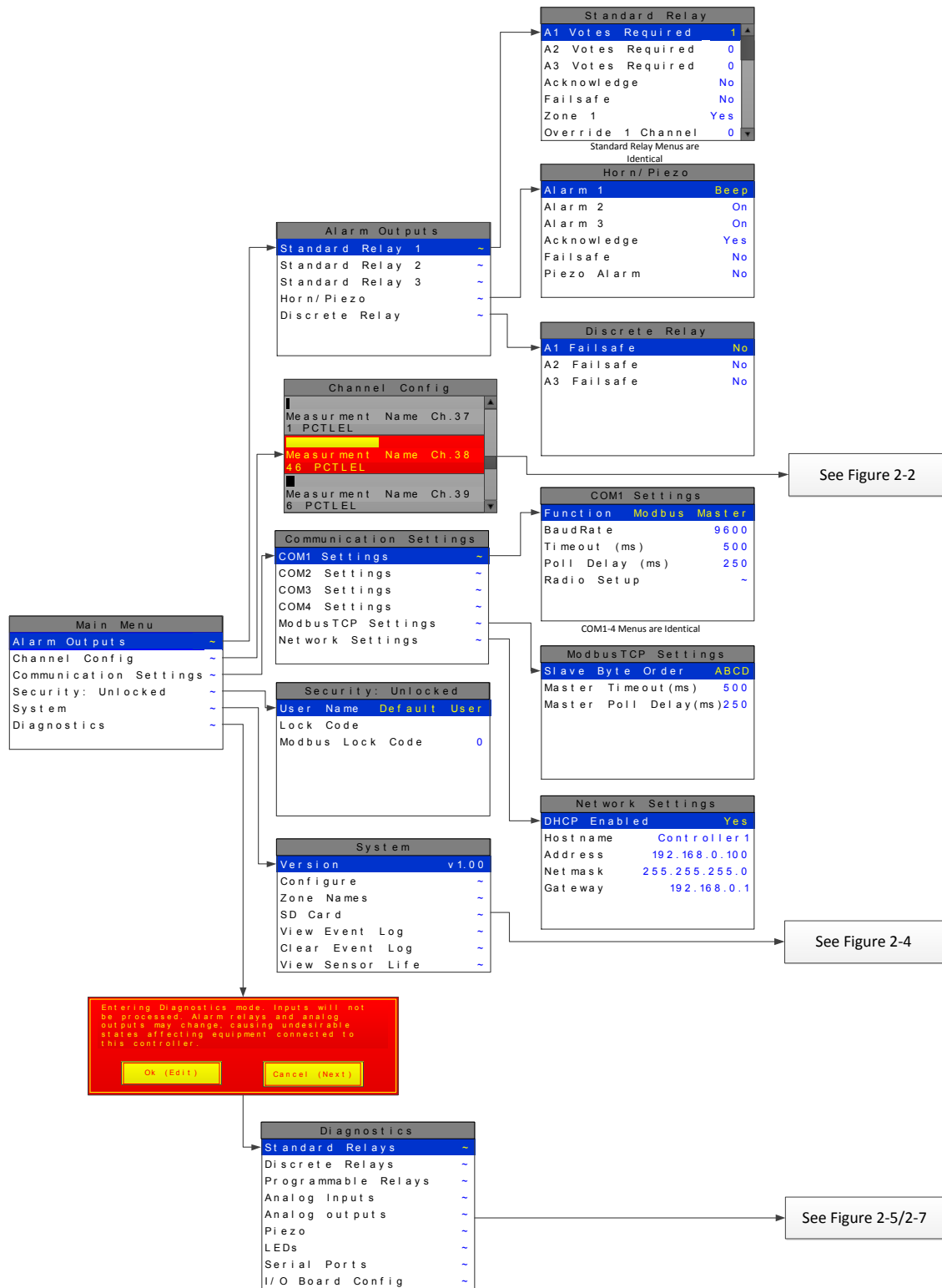

Figure 2-1

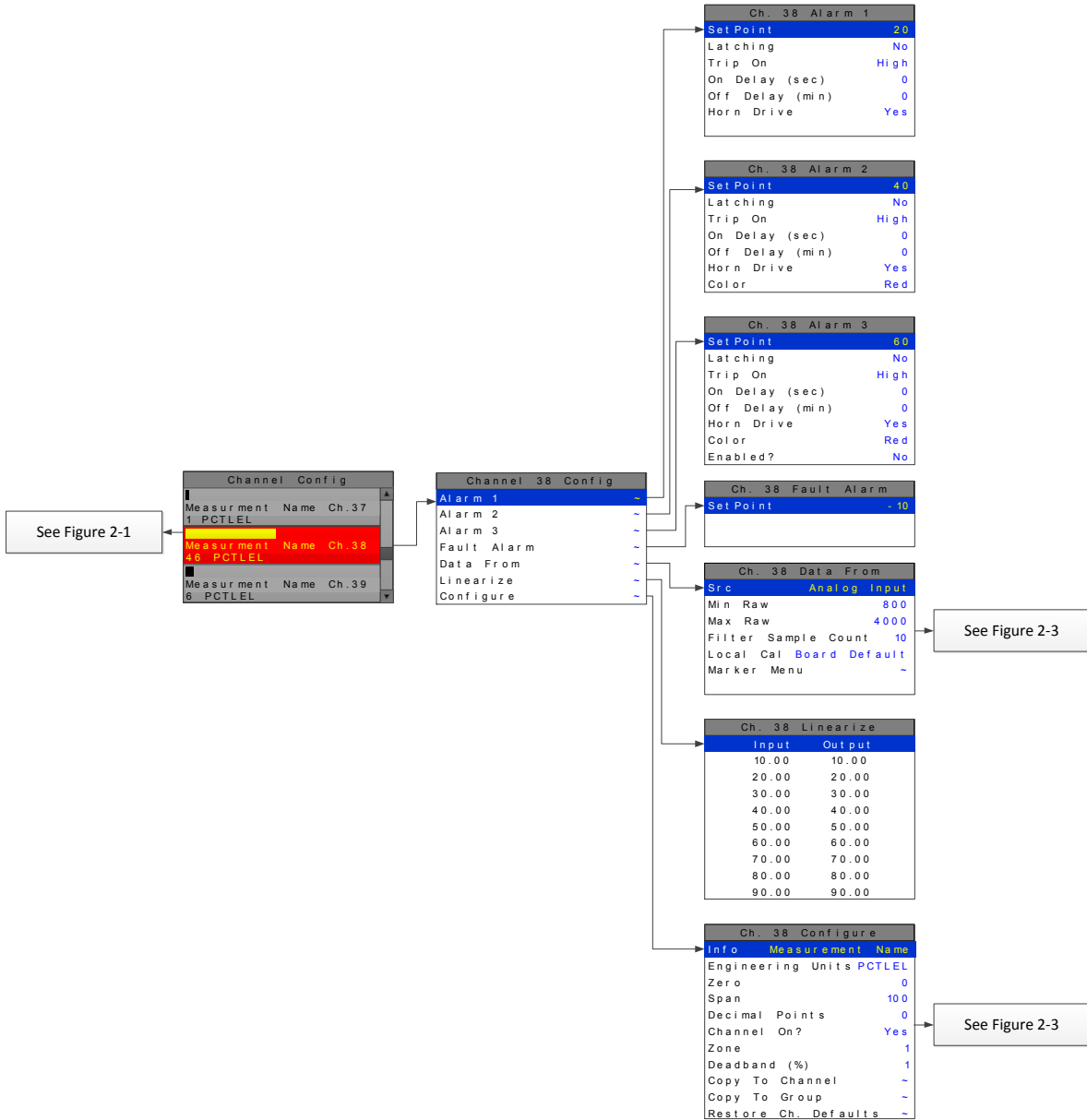

Figure 2-2

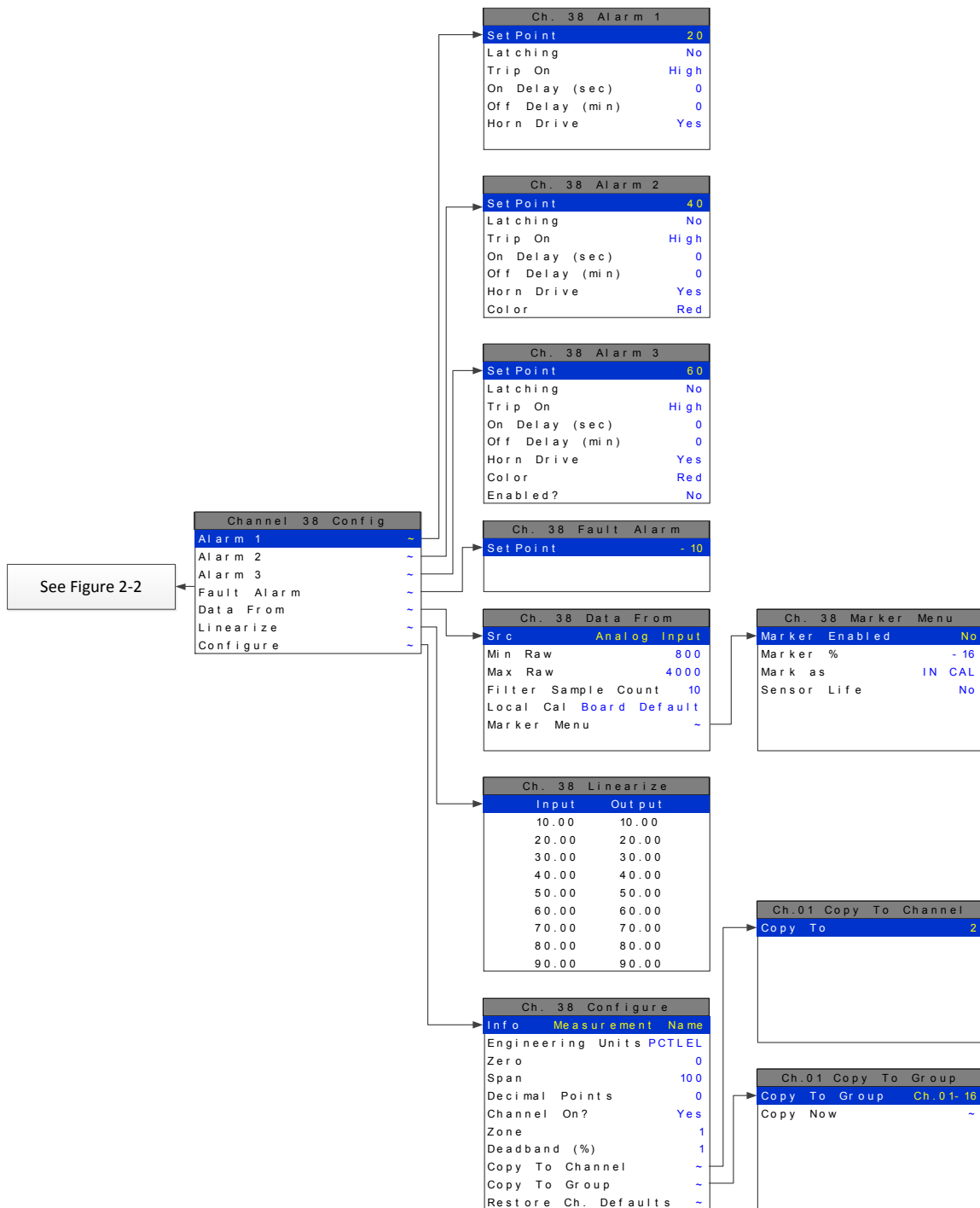

Figure 2-3





Figure 2-4

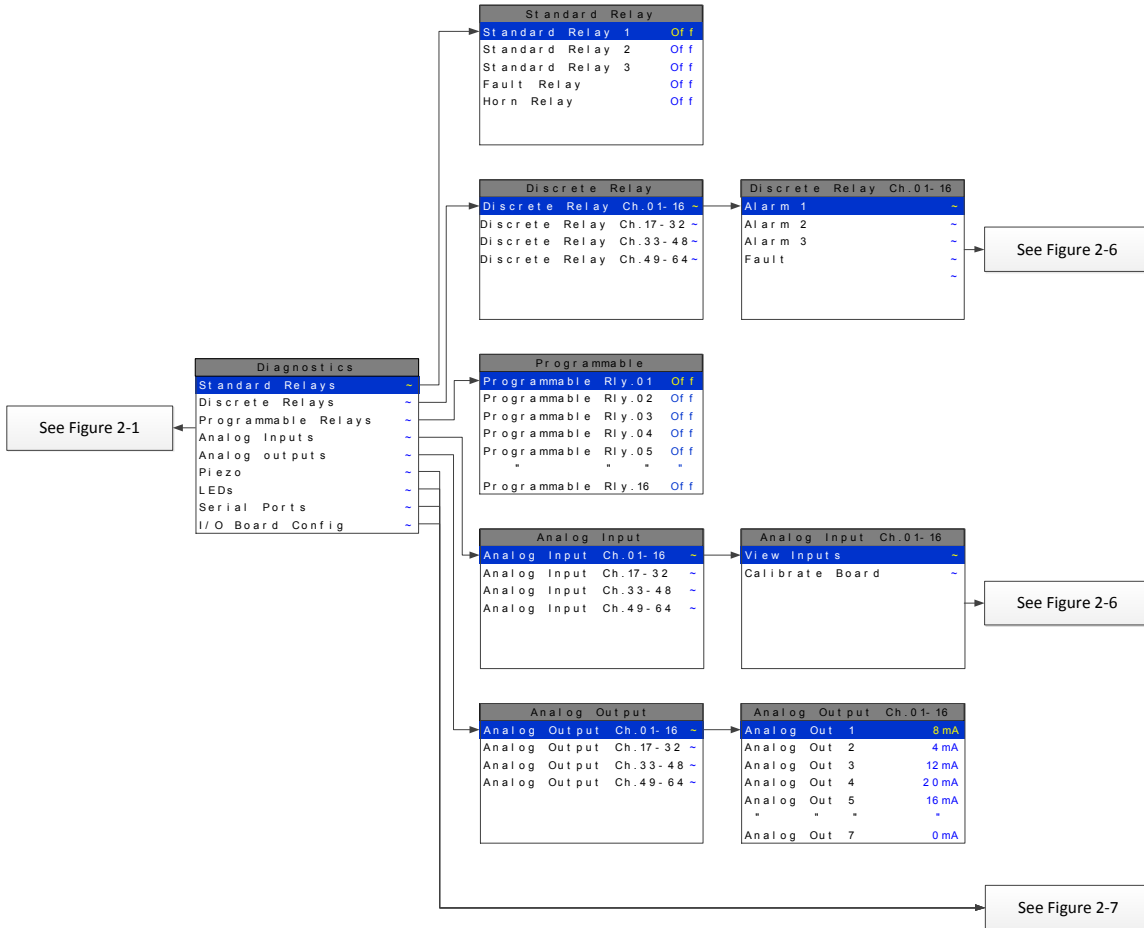

Figure 2-5

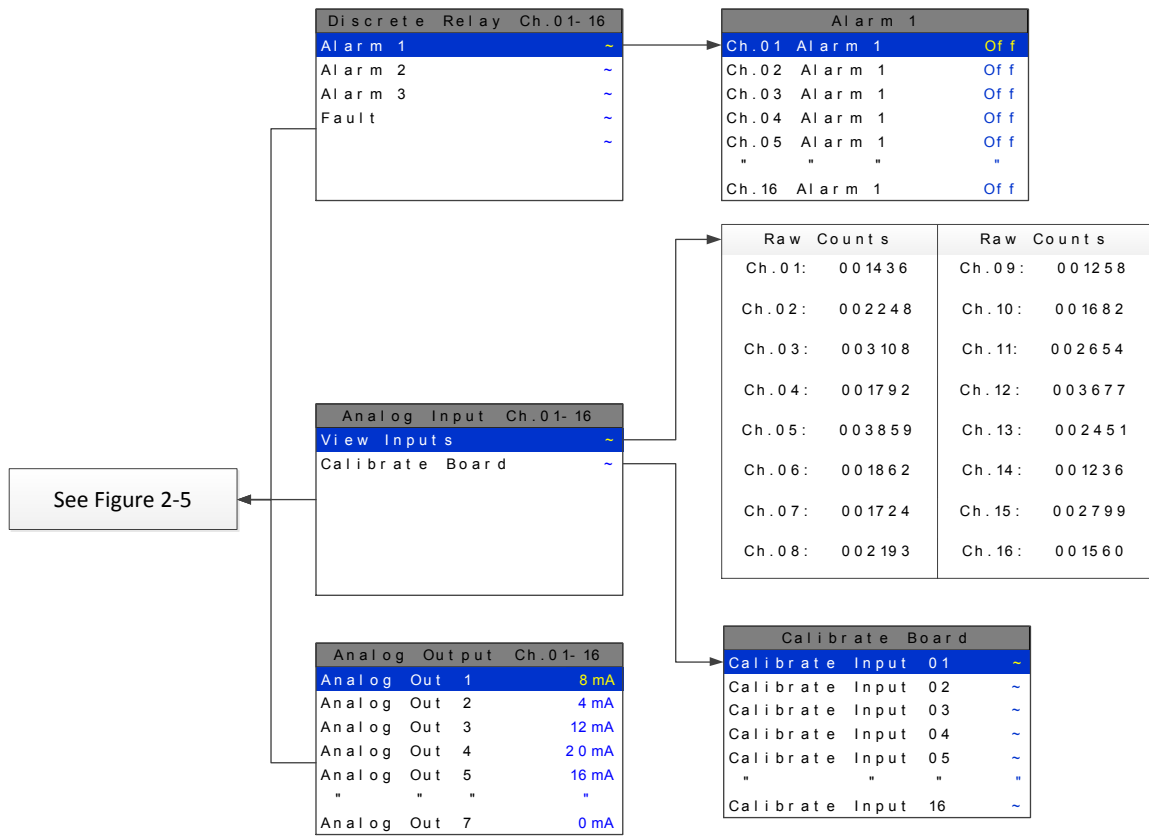

Figure 2-6

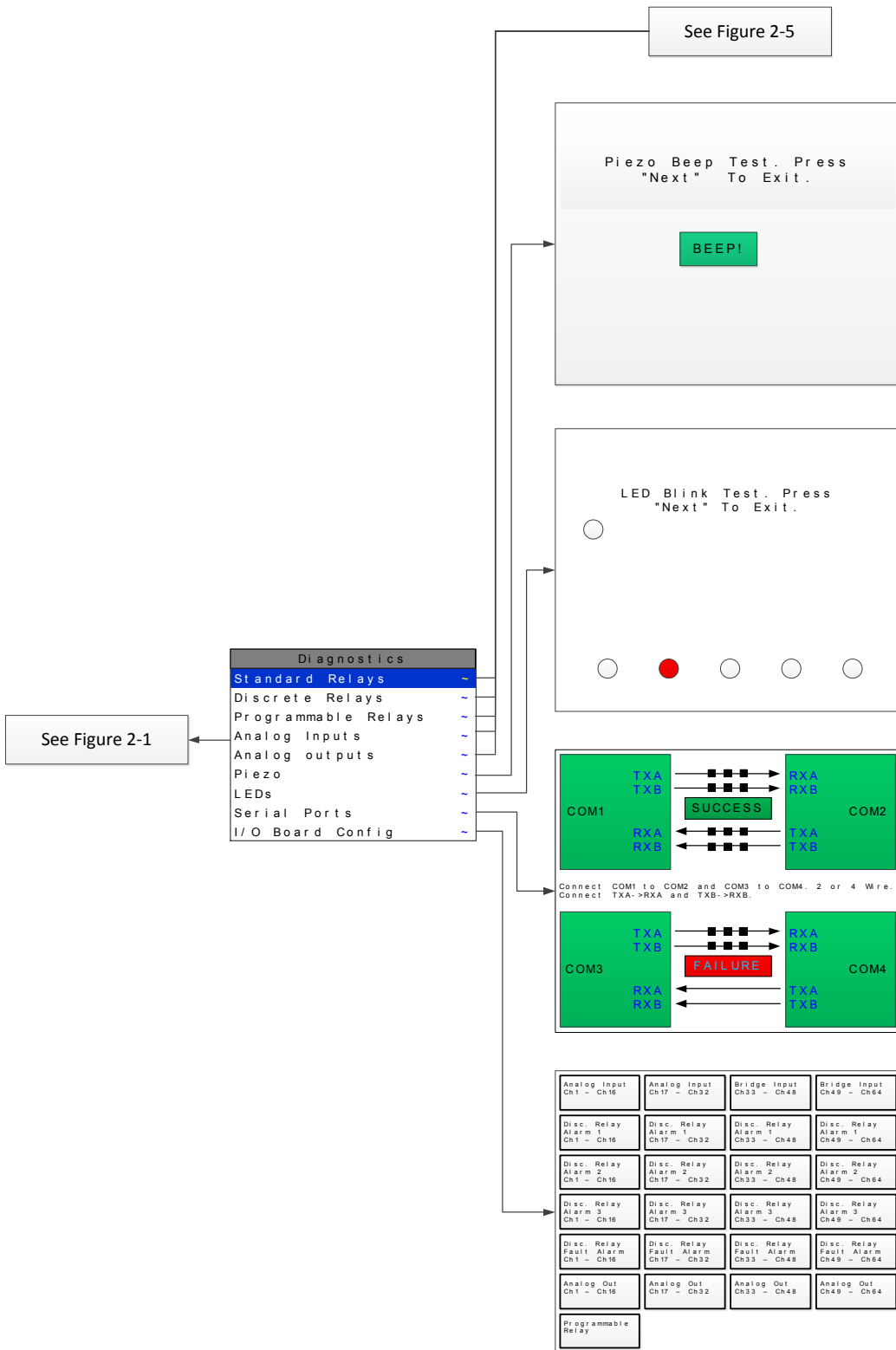













Figure 2-7

## 2.2 CHANGING MENU VARIABLES USING THE KEYPAD

Upon entering a menu, a blue highlight bar controlled by / indicates the selected variable. Some are simple **YES/NO** or **ON/OFF** entries toggled by pressing . Others, such as *Measurement Name* and *Eunits* fields may have many ASCII character possibilities. Allowed ASCII characters are as follows: ABCDEFGHIJKLMNOPQRSTUVWXYZ[\]^\_`abcdefghijklmnopqrstuvwxyz{|}~ blank space !"#->%&`()\*+,-./0123456789;<=>?@.  places a cursor over the item and / scrolls through each allowed entry. / move the cursor within a field. When the field is complete,  clears the cursor and loads it into non-volatile memory where it is retained indefinitely and  will cancel any changes that have been made in the active field. With no cursor present,  closes open menus in reverse order and returns the LCD to the most recent data display.

## 2.3 ALARM OUTPUTS

The menu item identified as **ALARM OUTPUTS** is accessed through the *Main Menu*. Selecting it allows users to configure the different types of outputs that can be connected to the ViewSmart 6400 controller through the menu shown in Figure 2-8. The variables under this menu are **STANDARD RELAY 1, STANDARD RELAY 2, STANDARD RELAY 3, HORN/PIEZO, DISCRETE RELAY,** and **PROGRAMMABLE RELAY BOARD.**

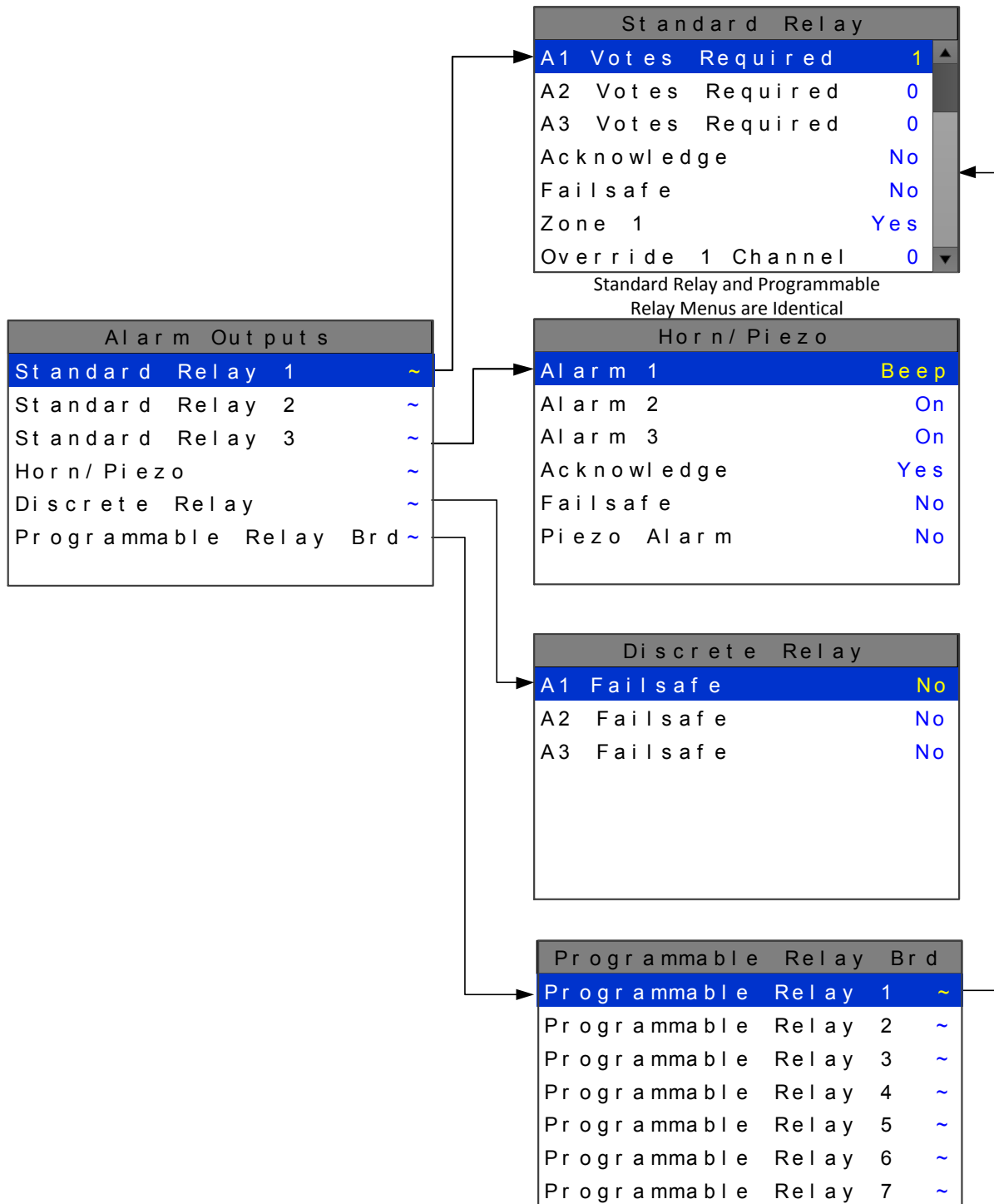

Figure 2-8

### 2.3.1 STANDARD RELAY 1, 2, AND 3

Every ViewSmart 6400 comes standard with three programmable relays that the user can individually program to suit their needs. This is achieved through the **STANDARD RELAY** menus accessed from the **ALARM OUTPUTS** menu. Only one Standard Relay menu screen is shown in Figure 2-9 because all the standard relay's menus are identical. Under the **STANDARD RELAY** menu the user can configure the following.

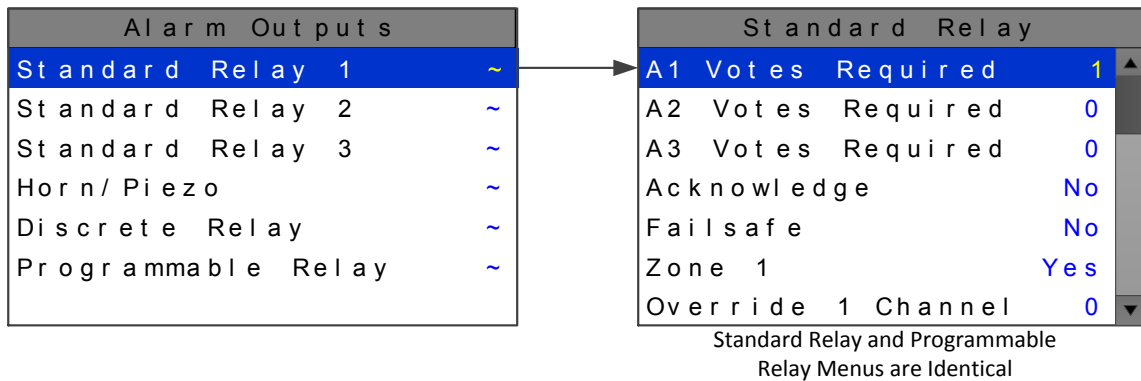

Figure 2-9

#### 2.3.1.1 A1 A2 & A3 VOTES REQUIRED

**A1 Votes Required, A2 Votes Required, & A3 Votes Required** are the number of A1, A2, & A3 level alarms that must be present for the relay to activate. This allows creation of logical AND function equations that control standard relays. Default settings for standard relay 1 are **A1 Votes = 01 A2 Votes = 00 & A3 Votes = 00** which causes relay 1 to trip if any channel has an A1 level alarm active. Default settings for standard relay 2 are **A1 Votes = 00 A2 Votes = 01 & A3 Votes = 00** which causes relay 2 to trip if any channel has an A2 level alarm active. Example: If either default setting is modified such that **A1 Votes = 02 and A2 Votes = 01**, then any two channels must have an A1 level alarm active and any one channel must have an A2 level alarm active to trip that relay. **REMEMBER!** One of the A1s and the A2 could be on the same channel. These level alarms must come from a channel included in the **Zone** entry described below.

#### 2.3.1.2 ACKNOWLEDGE

Turning **Acknowledge YES** allows the standard relay to be deactivated during alarm conditions by an **Alarm Reset**. This is useful if an audible device is being driven by the relay

### 2.3.1.3 FAILSAFE

**Failsafe** controls relay activation for this standard relay. **Failsafe YES** causes the relay to de-energize during alarm conditions and energize when there is no alarm. Thereby, a power failure forces the relay contact to the alarm position. Note the standard Fault relay is always failsafe and may be monitored separately to indicate loss of power conditions in many applications.

### 2.3.1.4 ZONE 1-8

**Zones** offer additional flexibility by controlling which channel zones trip this menu's standard alarm relay. There are eight possible zones that can be assigned to the relays individually. Some applications have different types of sensors, or sensors in different areas connected to the same ViewSmart 6400 Controller. In these cases, it may be undesirable for a sensor in one area to trip the same relay as a sensor in another area. The **Zone** menus may restrict this. For example, channels 1-32 might be set to trip standard relay 1 while channels 33-64 trip standard relay 2. This is done by assigning channels 1-32 to zone 1 and channels 33-64 to zone 2 and turning only zone 1 to **YES** for Standard relay 1 and only zone 2 to **YES** for standard relay 2. Another possibility is channels 1-32 be set to trip standard relay 1 while channels 33-64 trip relays on an optional discrete relay PCB configured for Alarm 1 ([see section 3.2.2](#)).

### 2.3.1.5 OVERRIDE CHANNELS 1-8

**Override** allows entering one of the 256 different alarms that will trip this relay regardless of the **Votes** or **Zone** entries. There are four alarms per channel and 64 channels and any one of these alarms may be used as the Over Ride. This feature is useful when one channel's alarm has more significance than the others. Up to eight override alarms may be entered per relay.

## 2.3.2 HORN/PIEZO

The ViewSmart 6400 is equipped with a low decibel audible piezo which chirps when keys are pressed and may be configured to audibly indicate alarm conditions. The standard horn relay is similar to the standard A1 & A2 relays.

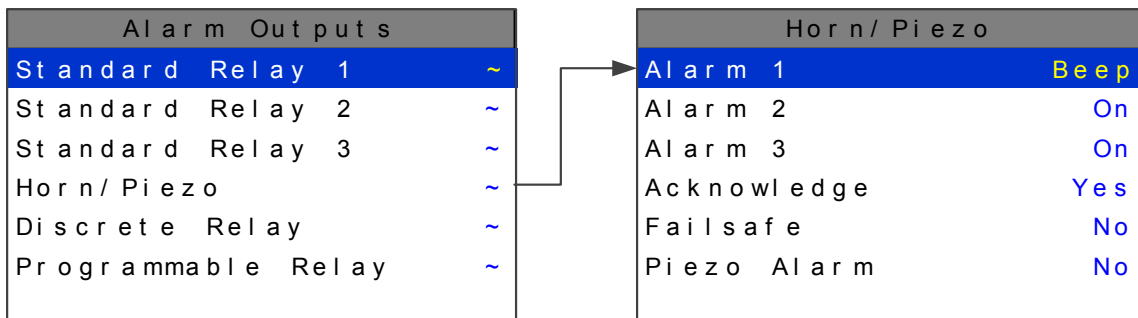

Figure 2-10

### 2.3.2.1 A1 A2 & A3

**Alarm 1, Alarm 2, & Alarm 3** menus control how this alarm level from each channel will affect the standard horn relay. Choices are **OFF**, **ON** or **BEEP** (one Hz. Pulsating). As an example, A1 conditions might pulse the horn (**BEEP**) and A2 conditions to cause a steady horn (**ON**). Any other combination of these 3 choices is possible for A1, A2, and A3 levels affecting the horn relay. This feature is very useful since it allows the horn relay to serve as another level A1, level A2, level A3 or both. Individual channel alarms may also be configured to not affect the Horn relay on a channel by channel basis ([see section 2.4.2.5](#)).

### 2.3.2.2 ACKNOWLEDGE

Turning **Acknowledge YES** allows the Horn relay to be deactivated during alarm conditions by an **Alarm Reset**. This is useful if an audible device is being driven by the relay

### 2.3.2.3 FAILSAFE

**Failsafe** controls relay activation for this relay. **Failsafe YES** causes the horn relay to de-energize during alarm conditions and energize when there is no alarm. Thereby, a power failure forces the relay contact to the alarm position.

### 2.3.2.4 PIEZO ALARM

**Piezo Alarm ON** causes the audible piezo to duplicate the action of the horn relay. This feature may be used to provide a low decibel indication of the status of the system's horn.

## 2.3.3 DISCRETE RELAY

10-00345 Discrete relay options may also be configured to function in a *Failsafe* mode using the **ALARM OUTPUTS** menu shown in Figure 2-11. Entering **YES** causes these discrete relays to have energized coils when no alarm condition exists for the associated channel and de-energized coils when the alarm occurs. *Failsafe* is useful for indicating failed relay coils and loss of power conditions.

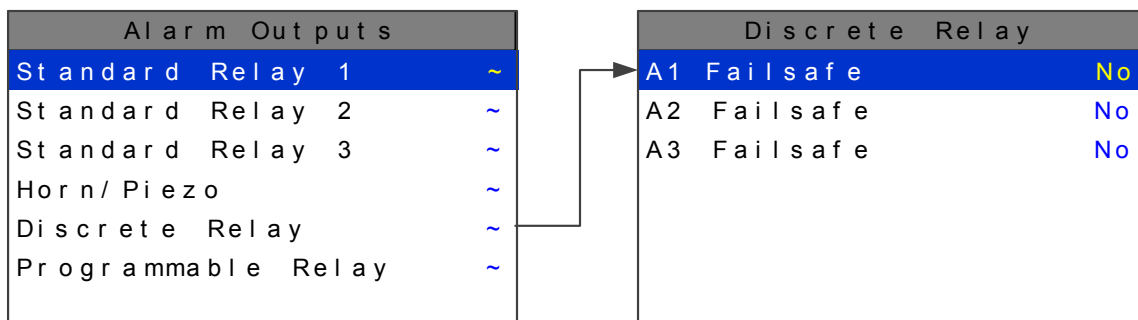

Figure 2-11



### 2.3.4 PROGRAMMABLE RELAY

The ViewSmart 6400 supports up to 2 10-0350 Programmable Relay Option Boards. The 10-0350 Programmable relay option board may be added if the user needs sixteen more programmable relays in addition to the three standard relays. These 16 relays are configured through the **PROGRAMMABLE RELAY** menus accessed from the **ALARM OUTPUTS** menu show in Figure 2-12. Only one Programmable Relay menu screen is shown because all the Programmable relay's menus are identical. Under the **PROGRAMMABLE RELAY** menu the user can configure the same parameters as **STANDARD RELAYS** discussed in [section 2.3.1](#).

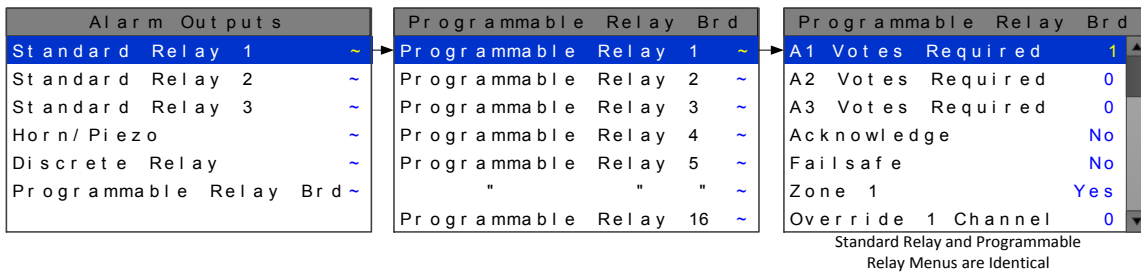





Figure 2-12

### 2.4 CHANNEL CONFIGURATION ENTRY MENU

**CHANNEL CONFIGURATION** is accessed through the **MAIN MENU**. Once in the

**CHANNEL CONFIGURATION** entry menu, show on left in Figure 2-13; use  /

 to scroll up or down to select the channel that is to be configured. Once the

correct channel is selected  brings you to that channel's configuration menu, shown on right below. These items affect only the specific channel selected. *System* specific variables are accessed through the **MAIN MENU** shown in Figure 2-1.

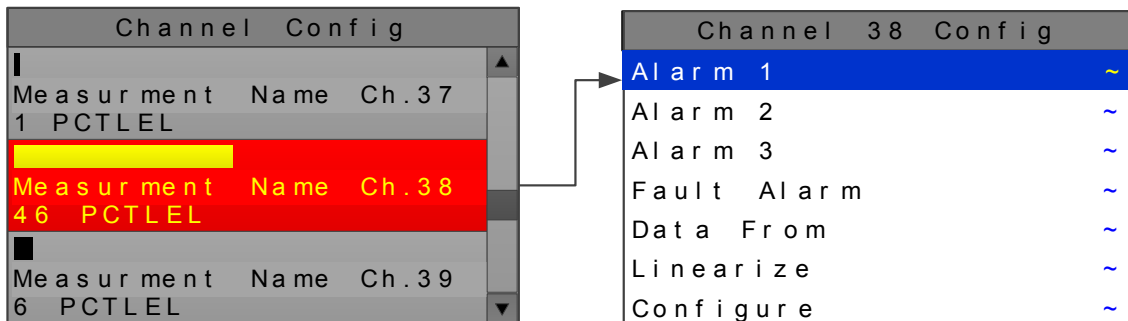

Figure 2-13

### 2.4.1 CHANNEL CONFIGURATION MENUS

Once the appropriate channel has been selected its configuration menu allows the following parameters to be accessed: **Alarm 1**, **Alarm 2**, **Alarm 3**, **Fault Alarm**, **Data From**, **Linearize**, and **Configure**.

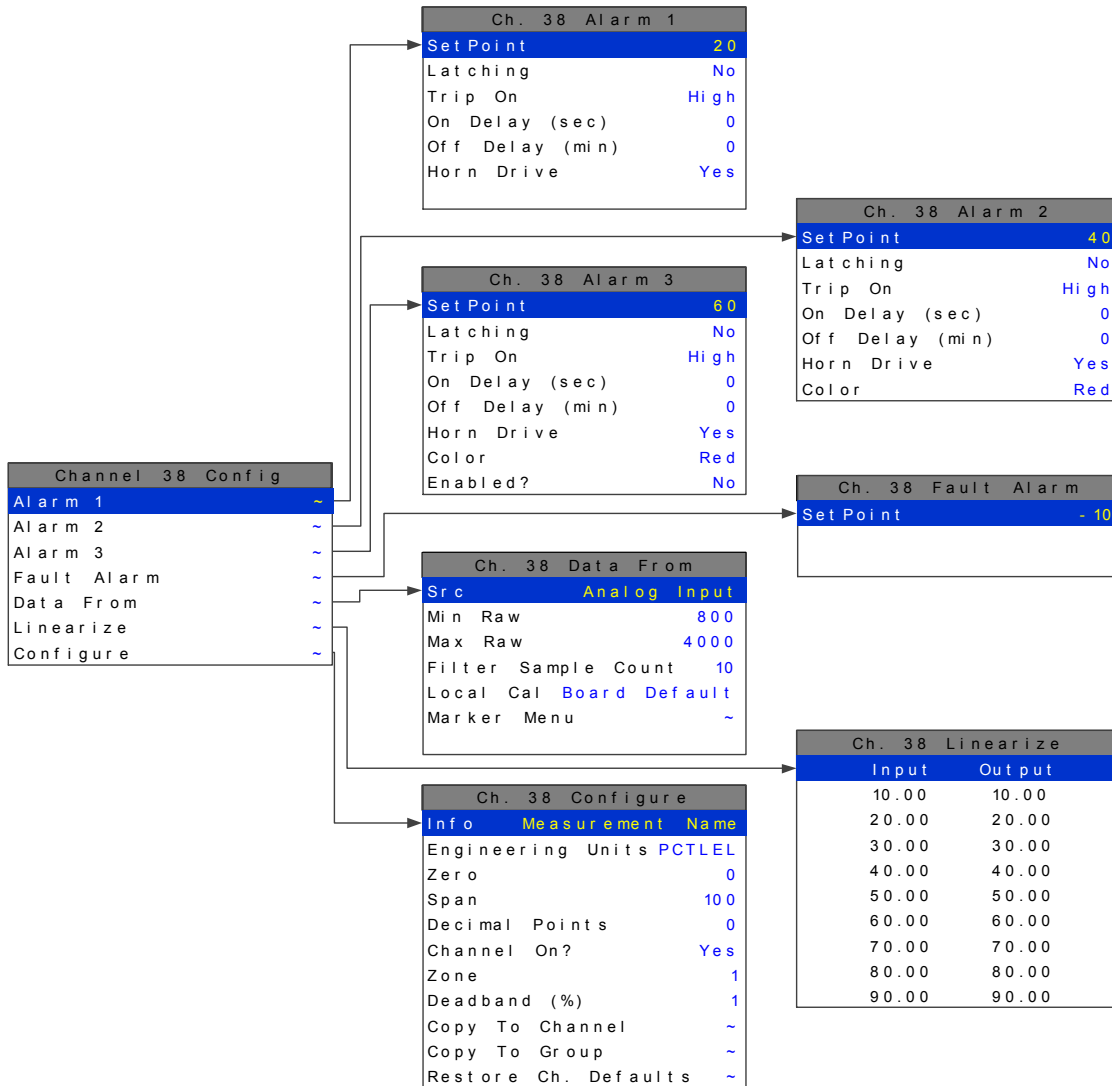

Figure 2-14

### 2.4.2 ALARM 1 / ALARM 2 / ALARM 3 MENU

The **ALARM MENU** parameters are listed only once, because alarms 1, 2, and 3 are identical except A1 does not have the option to change the color, it is always yellow,

and only A3 can be turned off if not needed. The following parameters can be accessed while in the **ALARM MENUS**.

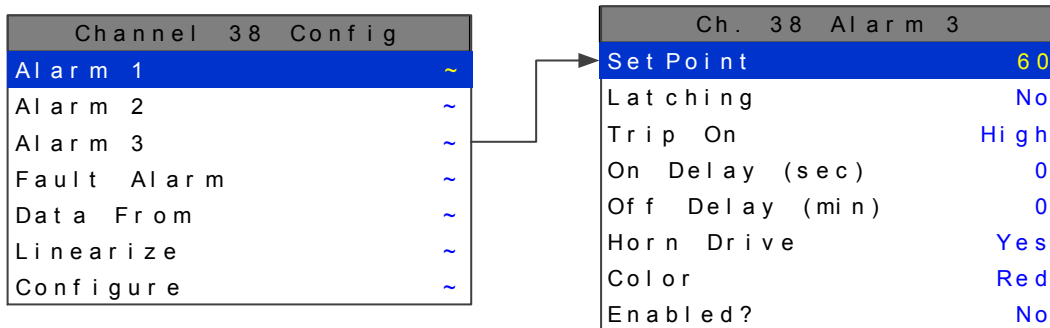

Figure 2-15

#### 2.4.2.1 SETPOINT

**SETPOINT** is the value where the alarm trips. It is entered in engineering units. For example, if a channel monitors 0-50 ppmH<sub>2</sub>S and the alarm must trip at 10 ppm, the correct entry is 10.00.

#### 2.4.2.2 LATCHING

**LATCHING** determines either manual or automatic alarm reset operation. **YES** requires a manual **Alarm Reset** to unlatch the alarm even though an alarm condition no longer exists. **YES** also causes this alarm group's common relay, front panel LED, and optional discrete relay to latch. **NO** allows all outputs for this alarm to automatically reset as soon as the alarm condition clears.

#### 2.4.2.3 TRIP ON

**TRIP ON** is set to **HIGH** for increasing alarms or **LOW** for decreasing alarms to determine if the alarm activates upon exceeding or falling below the setpoint.

#### 2.4.2.4 ON/OFF DELAYS

The **ON DELAY / OFF DELAY** entries allow **ON** and **OFF** time delays affecting how long the setpoint must be surpassed before an alarm event transition occurs. **ON** delays are limited to 10 seconds while **OFF** delays may be as long as 120 minutes. Delays are useful in many applications to prevent nuisance alarms and unwanted cycling into and out of alarm conditions.

#### 2.4.2.5 HORN ON

The **HORN ON** entry allows linking this alarm to the common horn relay. **NO** causes the alarm to have no effect upon the horn relay. Entering **YES** causes this alarm to turn the horn relay on steady, or, to pulse it depending upon horn configuration in the system menu ([see section 2.3.2.1](#)).

### 2.4.2.6 COLOR

**COLOR** gives the option of assigning A2 or A3 alarms different colors besides the default RED. The options are RED BLUE and ORANGE.

### 2.4.2.7 ENABLED

**ENABLED?** Alarm 3 only. Because most applications require only two alarm levels, A3 is turned **NO** (off) from the factory. **YES** activates the A3 alarm level if needed.

## 2.4.3 FAULT ALARM MENU

The channel alarm identified as Fault activates when the input is out of range in the negative direction. The fault level is always low trip and the dedicated common fault relay is always failsafe. The minimum setting is -10% of full scale. The factory default setting is -10; which is -10% of 100 or default full scale value. If the full scale value is changed the fault value is automatically updated to reflect the new value. For example if the fault level is -10 and the full scale value is changed from 100 to 50 the fault level will automatically changed to -5 which is -10% of the new full scale value. If the fault level is -5 (-5% of full scale) and the full scale value is changed from 100 to 50 the fault level will automatically changed to -2.5 which is -5% of the new full scale value.

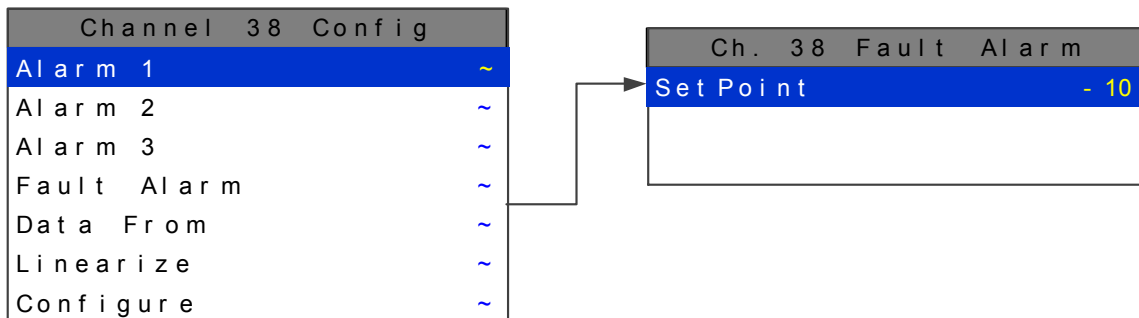

Figure 2-16

## 2.4.4 DATA FROM MENU TO SET INPUT SOURCE

Channels may be independently configured to accept input data from the following sources:

- An analog input PCB attached to the I<sup>2</sup>C bus. These include *Analog and Bridge* input boards.
- Modbus RS-485 from up to four configured master ports connected to Modbus slave devices.
- Modbus TCP/IP connected to the Ethernet port.

**Note:** Each *Modbus* menu selection also requests the RTU # and the Alias register # location of the data to be retrieved from the RTU. Alias register

numbers define the location of the variable representing the input value and must be obtained from the manufacturer of the Modbus RTU device.

- One of our Radio Modem kits may be connected to the Modbus RS-485 master port to enable wireless communication to ST-48/RF wireless sensor transmitters. [See section 7.2.](#)

Channel's inputs are configured using the following parameters in the **DATA FROM MENU**.

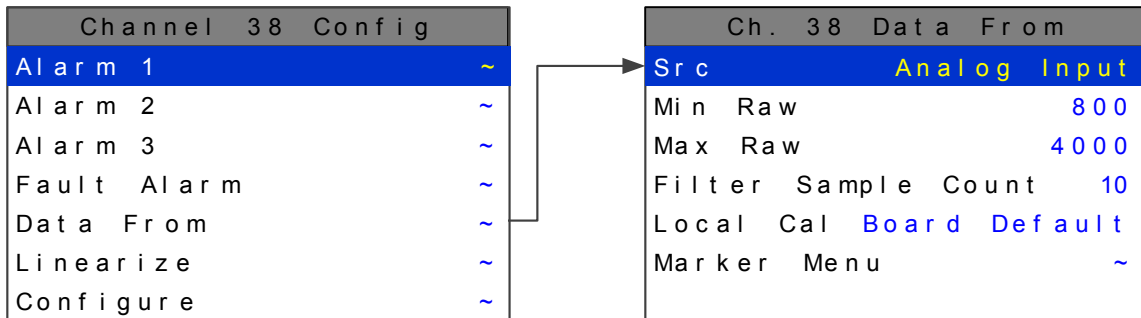

Figure 2-17

### 2.4.4.1 SOURCE

toggles the **SRC** or source entry between *Analog, Modbus 16bit, Modbus 16bit Signed, Modbus 32bit, Wireless Monitor, and Digital Input*. This parameter tells the ViewSmart 6400 where the information to be displayed comes from. Each 16 channel group can have multiple sources. For example if an application needs 12 4-20 inputs and 52 Modbus inputs the first 12 channels can be programmed for *Analog* input and the last 52 channels can be programmed to accept the Modbus inputs. For Modbus 16bit, a single register will be interpreted as an unsigned 16bit integer. For Modbus 16bit signed, a single register will be interpreted as a signed 16bit integer. For Modbus 32bit, 2 consecutive registers are read and interpreted as a 32bit IEEE Floating Point value. In 32bit Mode, the register value is read directly and not scaled with Min/Max Raw parameters.

### 2.4.4.2 MIN RAW & MAX RAW

**MIN/MAX RAW** is the Min Raw and Max Raw counts entries included in Input Data From: menus define the range of input counts that provide *Measurement Range* read-out values described in [section 2.4.6.2](#). This menu entry is determined by the A/D converter resolution of the channel's input. For example, if the input is a 10 bit Modbus® device with zero at 200 counts and 100% at 1000 counts, then this menu's MIN should be set at 200 and MAX at 1000. If communicating with the ViewSmart 6400's optional 12 bit Analog Input PCB the MIN should be 800 and the MAX 4000.

If the input device's resolution is unknown, the live counts variable on the Combination screen displays actual raw A/D counts currently being read by this channel. This reading may be used to test the input device for what A/D counts are provided for zero and 100% if these values are unknown. Forcing the input device to read zero should provide the A/D counts value needed to make this channel's display also read zero. Likewise, forcing the input device to read 100% should provide the A/D counts value needed to make the ViewSmart 6400 channel's display also read 100%.

Note: Each *Data From:* item has a matching default Min/Max counts value of 20% to 100% with  $\pm 5\%$  over/under range applied. If the default value is incorrect for the input device it should be edited.

#### 2.4.4.3 FILTER SAMPLE COUNT

The **FILTER SAMPLE COUNT** is the number of samples from an Analog Input channel that are averaged together before displayed. The valid range is 1-40 with the default value of 10. If a channel has a noisy input the sample rate can be increased causing the noise to average itself out. This higher number of samples causes the channel to react slower to input.

#### 2.4.4.4 LOCAL CAL

**LOCAL CAL** is available with the Analog Input option. There are three choices *Board Default, On, and Off*. With the Analog Input option used for both the Analog and Bridge input boards, *Board Default* automatically turns the local calibration feature **On** for the Bridge input and **Off** for the Analog Input. If there is a need to calibrate a channel locally and the board default is **Off** it can be manually changed.

ViewSmart 6400 CAL MODE features allow pushbutton calibration of zero and span values. This feature should be utilized only when there are no other zero/span controls within the monitoring system since it is inappropriate to calibrate a signal at more than one point. Therefore, if calibration is to be performed at another transmitter or monitoring device, the ViewSmart 6400 CAL MODE feature should not be used.

The CALIBRATION MENU allows entering the correct **Cal ZERO & Cal SPAN** set-point values needed to calibrate the sensor. These are entered in the same engineering units as input range. **Set Zero & Set Span** controls in this menu allow pushbutton

calibration by moving the highlight bar to each and pressing the . A live reading of the channel's value in the tool tip box allows calibration checks to see if an adjustment is needed. Unintentional calibrations are reset by the **Set Unity Gain** menu item. **Set Unity Gain** resets zero offset to 0 and span gain to 1. It is useful for returning the calibration to a known starting place. Sensor aging may be monitored by recording zero and span readings at **Unity Gain** when it is new, and again at later dates when degradation may have occurred.

To check zero calibration, apply the ZERO calibration value to the sensor and observe the live reading. If the zero reading differs from the zero setpoint, a calibration is

needed. To calibrate zero, move the highlight bar to **Set Zero** and press . A

warning message explains that pressing  again will change the zero calibration and any other key will exit. The procedure for span calibration is identical. For example, if a gas sensor is to be spanned with 50% span gas, the span set-point must be 50%. If 45% is to be used later, the span set-point must be changed to 45% to match the span calibration gas. If the reading is only 40% with the 50% gas applied, a span calibration is

needed. Move the pointer to the **Set Span** entry and press  twice. **Unity Gain** may be used at anytime to cancel incorrect calibrations and start again.

### 2.4.4.5 MARKER MENU

Some transmitters or monitoring devices providing ViewSmart 6400 inputs also indicate special modes of operation, such as *Calibration, Maintenance or Fault*, by transmitting a special <4mA or negative “Marker” value. The ViewSmart 6400 offers channel Marker menus for detecting and indicating such events (see Figure 2-18). While active, the ViewSmart 6400 displays a 6-digit ASCII message to indicate the special event and if equipped with 10-0348 4-20mA output option, the ViewSmart 6400 also transmits the same <4mA value.

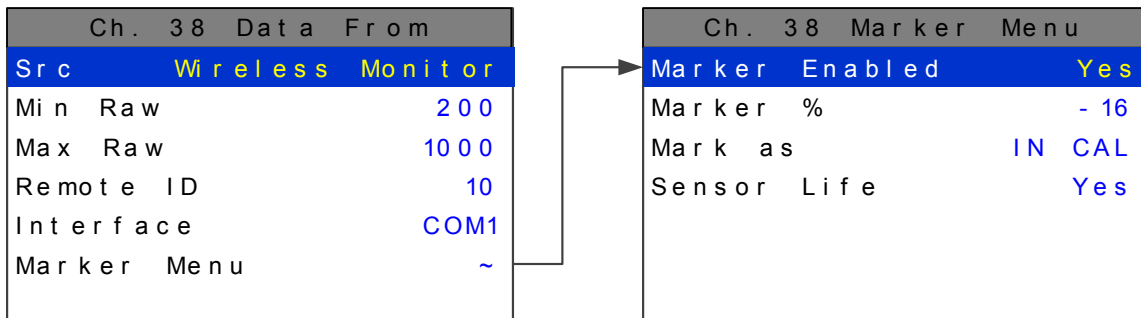

Figure 2-18

#### 2.4.4.5.1 Marker Enabled

Turns the marker feature ON and OFF

#### 2.4.4.5.2 Marker %

The negative Marker value is entered into the **Marker %** field as a negative percent of full scale. For example, -15.62% of full scale detects a marker value of 1.5mA (1.5mA is -

15.62% of full scale when 4-20mA is the range). Marker mode is active when the input value reads the Marker %  $\pm$  1% of full scale.

#### 2.4.4.5.3 Mark As

The **Mark As** menu allows user entry of the 6-digit ASCII message to be displayed when the marker is detected.

#### 2.4.4.5.4 Sensor Life

**Sensor Life** should only be activated when the Marker event is *Calibration* and when a sensor life value is transmitted after each calibration. This feature is provided primarily for use when interfacing the ViewSmart 6400 to R. C. Systems' ST-48 Sensor Transmitters which may be configured to transmit sensor life values after each calibration (Figure 2-19). For **Sensor Life** to record properly the monitor must perform as follows: After the *Calibration* Marker interval, 4.0mA transmits for 10 seconds to indicate its *calibration mode* is complete. The monitor then transmits between 4.0mA and 5.0mA for five seconds depending on remaining sensor life where 4.0mA = 0% and 5.0mA = 100% remaining sensor life. The ViewSmart 6400 reads this value and records it as the channel's **Sensor Life**. **Sensor Life** is stored in the ViewSmart 6400 Modbus database and displayed as a bar-graph in the Sensor Info screen ([see section 2.7.7](#)). It is a useful tool for planning sensor replacement schedules.

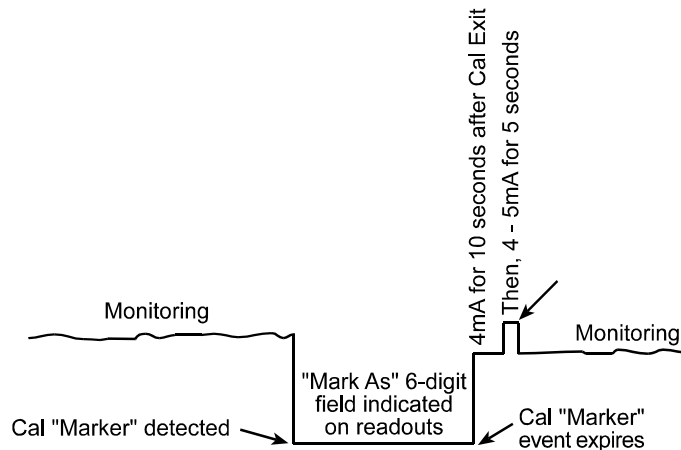

Figure 2-19

#### 2.4.4.6 REMOTE ID

When the Data From is set to receive input through the Communications ports, this is where the slave's unique ID number is entered. Remote ID numbers up to 247 are valid.

#### 2.4.4.7 ALIAS

The *Alias* register numbers define the location of the variable representing the input value of the Modbus data received through the Communications ports. This number must be obtained from the manufacturer of the Modbus RTU device.



### 2.4.4.8 INTERFACE

The *Interface* assigns what communication port the Modbus slave or Wireless radio is connected to and the channel will get its data from. The communication port that is assigned here must be configured as a Modbus Master or Wireless Monitor in the Communications Menu ([see section 2.5.1](#)).

### 2.4.4.9 SLAVE BYTE ORDER

If Modbus 32 BIT is selected, a Byte Order entry appears at the bottom of the menu. This determines WORD and BYTE alignment of data at the remote Modbus transmitter when sending its 4 byte IEEE Floating Point values. With the select bar on this entry, the  toggles between the 4 possible modes.

### 2.4.5 LINEARIZE

The linearization menu allows each channel to have its own linearization curve stored in the controller's non-volatile memory. Input versus output points must be entered in percent of full scale values. This means if the range is 0-200 ppmH<sub>2</sub>S then 100 ppm is 50% of full scale. Zero input will provide a zero output and 100% input a 100% output. Nine intermediate points may be entered to define the curve.

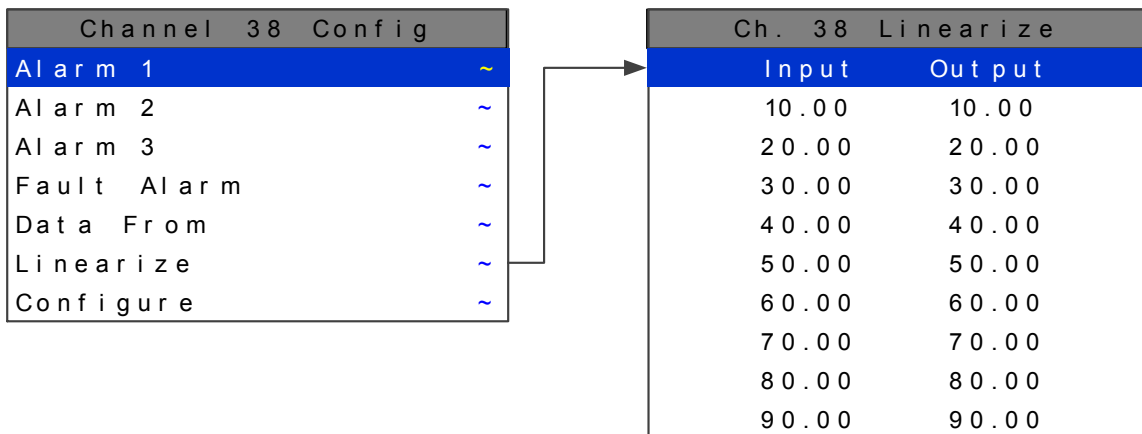

Figure 2-20

### 2.4.6 CONFIGURE MENU

From the entry level setup menu in Figure 2-14 the CONFIGURE menu may be entered for setting variables defining how the controller presents monitored data to the various graphic displays.

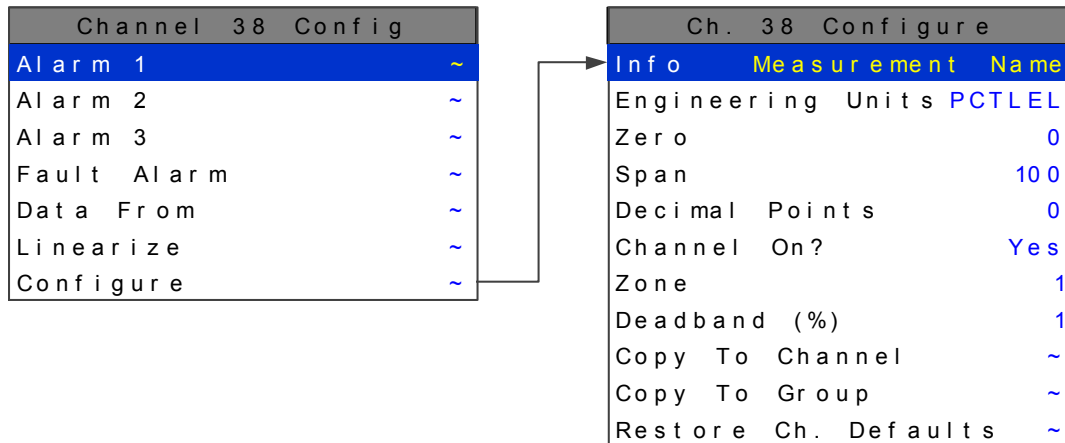

Figure 2-21

### 2.4.6.1 INFO / MEASUREMENT NAME

The first two items in this menu are for entering the 16 character *Measurement Name* and 6 character *engineering unit* ASCII fields. Eunits should define the units of measure for what this channel is to display. *Measurement Name* should describe the source of this data in the user's terminology. [Section 2.2](#) of this manual describes how to use the front keypad to modify these fields.

### 2.4.6.2 ZERO / SPAN

The **ZERO / SPAN** entries allow configuration of the measurement range displayed by this channel. Measurement Range works along with *A/D Counts* menus, described in [section 2.4.4.2](#), to define the range of the input signal's engineering units. For example, if a channel's input is 4-20mA from a transmitter monitoring 0 to 10ppm chlorine, then the **Zero** value should equal 0.000 and the **Span** value equal 10.00. The six ASCII engineering units previously entered are automatically displayed at the top of each menu as a reminder. Four digits must appear in this entry so trailing 0's may appear here that are not displayed on other data screens.

### 2.4.6.3 DECIMAL POINTS

Resolution of displayed channel values is configured in this menu by setting the number digits trailing the decimal point. Values are limited to a maximum of four digits, and a polarity sign. An auto-ranging feature displays the highest resolution allowed by this menu's decimal point entry. For example, if three decimal points are entered, and the range is 0 to 100ppm, the reading will be **0.000** at 0ppm and **100.0** at 100ppm. However, this may be undesirable due to the high resolution at zero unless the sensor's output is extremely stable. If decimal points are limited to one, the 0ppm reading

becomes **0.0** and the 100ppm reading remains **100.0**. Resolution may be limited further by setting decimal points to 0. In the above example, this would cause 0ppm to display **0** and 100ppm to display **100**.

#### 2.4.6.4 CHANNEL ON?

The **Channel On?** entry determines if this channel is to be utilized. Turning it off will cause the controller to never process inputs applied to this channel and no alarms will be tripped or data displayed. Inactive channels will be grayed out on the Main Data screen and skipped when scrolling through the 30 Minute Trend screens. Channels may be turned off in groups of 16. This is done in the System Setup menu described in [section 2.7.2.4](#).

#### 2.4.6.5 ZONE



The **ZONE** feature allows assigning of channels into up to eight possible **ZONES**. This is useful for applications that may need all of alike gases or inputs from a certain area to be grouped together. Once the channels are assigned to a certain group relays can be configured to respond to only the channels in this **ZONE** ([see section 2.3.1.4](#)).

#### 2.4.6.6 DEADBAND

DEADBAND allows forcing low values to continue to read zero. This is useful when there are small amounts of background gases that cause fluctuating readouts above zero. The highest amount of deadband allowed is 5%. The 4-20mA output is affected by this menu item and will remain at 4mA until the input gets above the programmed deadband level.



#### 2.4.6.7 COPY TO CHANNEL

This menu simplifies the Setup procedure by allowing similar channels to be copied from one to another. For example, if some channels are identical except for the *Measurement Name* entry, one channel could be configured and copied to the other channels that are the same. Only *Measurement Name* then must be configured on the

copied channels. Use  and  to select channel numbers and  once more to copy.

#### 2.4.6.8 COPY TO GROUP

This menu simplifies the Setup procedure by allowing one channel to be copied to a whole group of channels. For example, if some groups of 16 channels are identical except for the *Measurement Name* entry; one channel could be configured and copied to the whole group at one time. Only *Measurement Name* then must be configured on

the copied channels. Use  and  to select the group to be copied then



point to **Copy Now?** Press  once more to copy.

### 2.4.6.9 RESTORE CH. DEFAULTS

This menu allows the user to reset a specific channel to factory defaults without affecting any other channels. This is useful if a channel must be changed to a different input. All channel configuration will be reset and the user can configure the new parameters from the factory defaults. A confirming dialog box will appear before the channel is reset protecting against an accidental restore.

## 2.5 COMMUNICATION SETTINGS MENU

**COMMUNICATION SETTINGS** menu is accessed through the **MAIN MENU**. This menu is used to configure the four possible communication ports. Once in the

**COMMUNICATION SETTINGS** entry menu, show on left in Figure 2-22; use /  to scroll up or down to select the communication port that is to be configured.

Once the correct com port is selected  brings you to that com port's configuration

menu, shown on right below. Com ports 1-4 have identical menus and are shown only once.

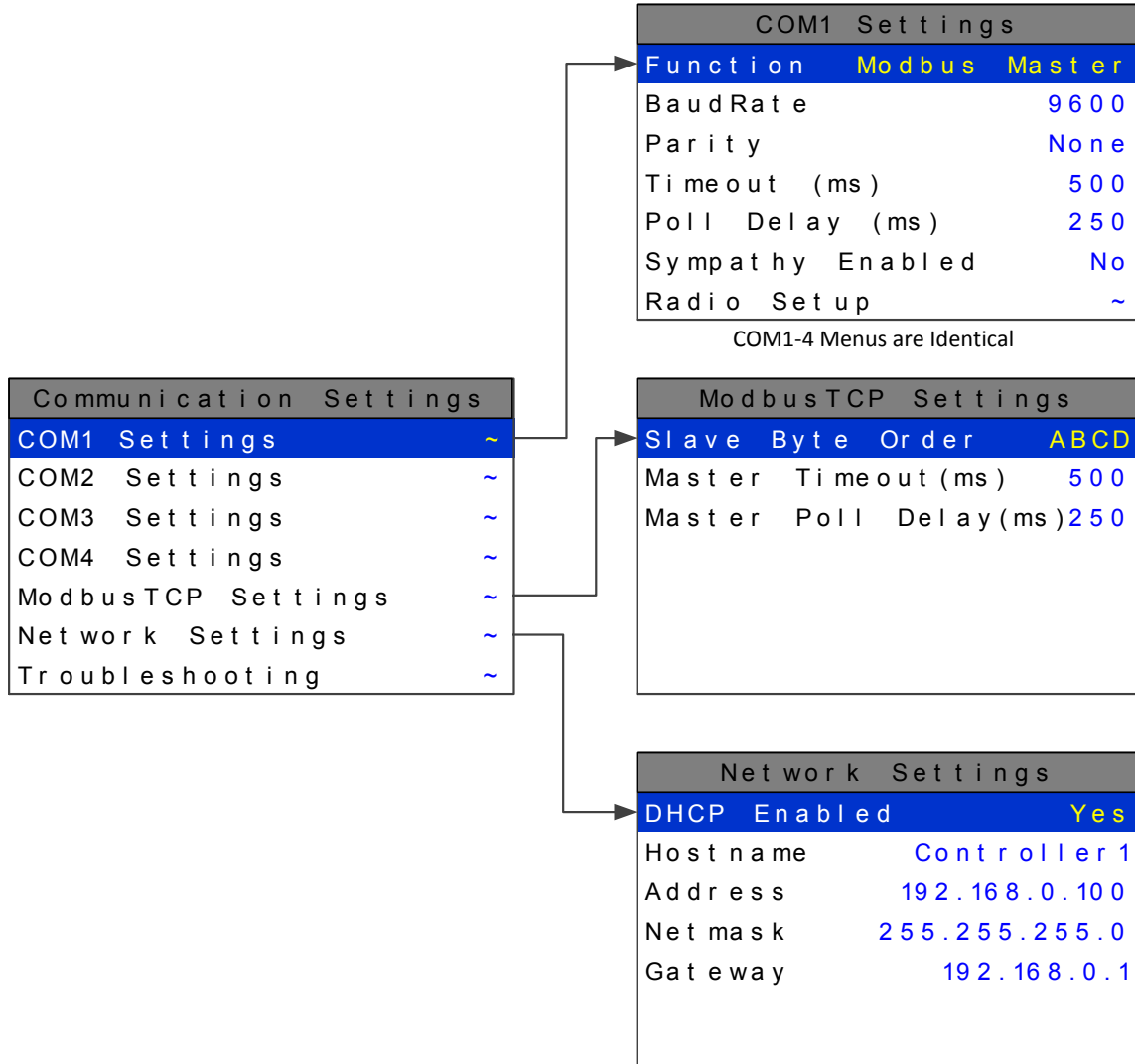

Figure 2-22

## 2.5.1 COM 1-4 SETTINGS

The four Modbus RS-485 ports can be individually configured multiple ways using the following menus.

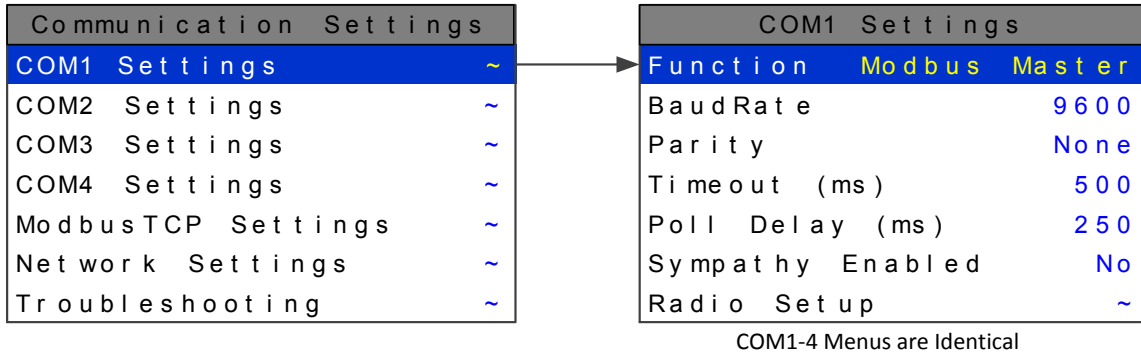

Figure 2-23

### 2.5.1.1 FUNCTION

The Function parameter allows the communication ports to be set as **Modbus Master**, **Modbus Slave**, **Wireless Monitor**, **Redundant Port**, or **Disabled**.

#### 2.5.1.1.1 Modbus Master

Master mode allows the communication port to poll any device using the Modbus RTU protocol. This setting is also utilized for Wireless Modbus Master. [See section 7.4.](#)

#### 2.5.1.1.2 Modbus Slave

Slave mode allows the communication port to be polled by any Modbus Master device using the Modbus RTU protocol. This setting is also utilized for Wireless Modbus Slave. [See section 7.3](#)

#### 2.5.1.1.3 Wireless Monitor

This mode is exclusively for wireless communication to our ST-48/RF wireless sensor transmitters (please visit [ST-48/RF](#)). [See section 7.2.](#)

#### 2.5.1.1.4 Redundant Port

This setting allows the user to create a redundant port which uses the settings from another port that is already configured. Redundant mode works with ports configured as **Modbus Master**. When configured as a redundant port, the **Primary** port communicates until it gets a communication error. The ViewSmart 6400 then switches to the redundant port and continues to poll the slave nodes. When communication has switched to the redundant port the ViewSmart 6400 trips the **Fault** relay, beeps, and displays a warning telling the user there has been a communication error. The user is able to **Ignore** the warning for 12 hours or **Test** the **Primary** port. Ignoring the problem

gives technicians time to trouble shoot and fix the problem. If the problem is not going to be fixed, the warning message can be cleared permanently by disabling the redundant port. If the user chooses to test the port and it passes, a success message will appear and the error message will be cleared.

Before a Primary port switches to its redundant port, a scan must fail 3 times. All channels setup to use the primary port are polled. At the end of the scan, if an error has occurred on any channel, the error count is incremented. After 3 scans fail, the redundant port takes over communication. If the redundant port also fails 3 times, communication is switched back to the primary port. When both ports fail, the ViewSmart 6400 will continuously switch between primary and redundant port.

Individual channels do not enter **COMM ERROR** mode unless both primary and redundant port failures occur.

Manual test can be performed on the redundant or primary port by going into the redundant port's com setting menu and selecting **TEST REDUNDANT PORT** or **TEST PRIMARY PORT**. While in this menu the ViewSmart 6400 also gives the active port on the screen.

#### 2.5.1.1.5 Disabled

Select Disable to turn the port off if not needed.

#### 2.5.1.2 BAUDRATE

This setting allows user to set the data rate of the communication port. The options include **9600**, **19200**, **38400**, **57600**, and **115200**.

#### 2.5.1.3 PARITY

A **PARITY** bit is a bit that is added to ensure that the number of bits with the value one in a set of bits is even or odd. Parity bits are used as the simplest form of error detecting code. The default is **None**.

#### 2.5.1.4 TIMEOUT

The Master **TIMEOUT** menu item affects the ViewSmart 6400's *master* Modbus ports. **TIMEOUT** is the length of time in milliseconds the controller waits before a Modbus request fails. Three consecutive failed requests must occur before a communication error is indicated. This item is useful for optimizing throughput to the ViewSmart 6400 from other slave RTUs.

#### 2.5.1.5 POLL DELAY

The time in milliseconds the unit will delay between Modbus master requests.

#### 2.5.1.6 SYMPATHY ENABLED

The sympathy feature allows multiple ST-90 Quad controllers, communicating on the same communication port, to go into an alarm condition simultaneously when any one

ST-90 controller detects an alarm condition. If SYMPATHY ENABLED is set to YES then the ViewSmart 6400 controller, which is the master in the network, broadcasts alarm flags to all ST-90s in the network. ST-90 controllers that are configured to react to these flags then energize their relays configured to trip for that alarm. The following sympathy parameters only show up if sympathy is set to **YES**.

#### 2.5.1.6.1 FAULT TRANSMIT

When set to **YES** the ViewSmart 6400 broadcasts the Fault alarm flag out of the communication port. This option is only available if SYMPATHY ENABLED is set to YES.

#### 2.5.1.6.2 A1 TRANSMIT

When set to **YES** the ViewSmart 6400 broadcasts the alarm 1 alarm flag out of the communication port. This option is only available if SYMPATHY ENABLED is set to YES.

#### 2.5.1.6.3 A2 TRANSMIT

When set to **YES** the ViewSmart 6400 t broadcasts the alarm 2 alarm flag out of the communication port. This option is only available if SYMPATHY ENABLED is set to YES.

#### 2.5.1.6.4 SYMPATHY A2 ACK

When set to **YES** the ViewSmart 6400 broadcasts the alarm acknowledge flag to acknowledge all ST-90 relays on the network configured to be acknowledgeable. This option is only available if SYMPATHY ENABLED is set to YES.

#### 2.5.1.6.5 A3 TRANSMIT

When set to **YES** the ViewSmart 6400 broadcasts the alarm 3 alarm flag out of the communication port. This option is only available if SYMPATHY ENABLED is set to YES.

#### 2.5.1.7 RADIO SETUP

**RADIO SETUP** is used to configure radio kits that are connected directly to the ViewSmart 6400. [See section 7.1.](#)

#### 2.5.1.8 SLAVE BYTE ORDER

If Modbus Slave is selected, a **BYTE ODER** entry appears in the menu. This determines WORD and BYTE alignment of data at the remote Modbus transmitter when sending its 4 byte IEEE Floating Point values. With the select bar on this entry, the toggles between the 4 possible modes. Min / Max Raw values are not used in this mode. 

#### 2.5.1.9 WIRELESS TIMEOUT

If Wireless Monitor is selected, a **WIRELESS TIMEOUT** entry appears in the menu.

The  toggles between 1m, 6m, 12m, and 18m. These represent the number of



minutes the ViewSmart 6400 will wait before going into COMM. ERROR. [See section 7.2.1.](#)

## 2.5.2 MODBUS TCP SETTINGS

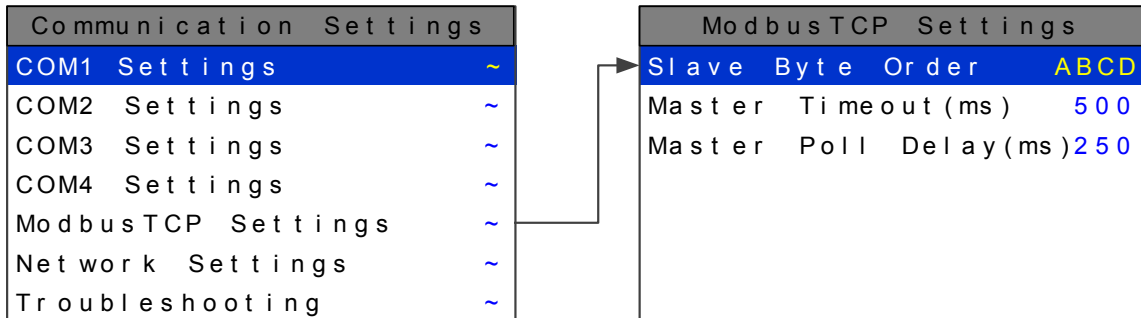



Figure 2-24

### 2.5.2.1 SLAVE BYTE ORDER

If Modbus Slave is selected, a **BYTE ORDER** entry appears in the menu. This determines WORD and BYTE alignment of data at the remote Modbus transmitter when sending its 4 byte IEEE Floating Point values. With the select bar on this entry, the toggles between the 4 possible modes. Min / Max Raw values are not used in this mode. 

### 2.5.2.2 MASTER TIMEOUT

The time in milliseconds before the unit gives up on a Modbus request and moves on to the next channel. After three consecutive timeouts, the channel enters the COM Error state.

### 2.5.2.3 MASTER POLL DELAY

The time in milliseconds the unit will delay between Modbus master requests.

### 2.5.3 NETWORK SETTINGS

See [section 10](#) for integrating a ViewSmart 6400 into an Ethernet network.

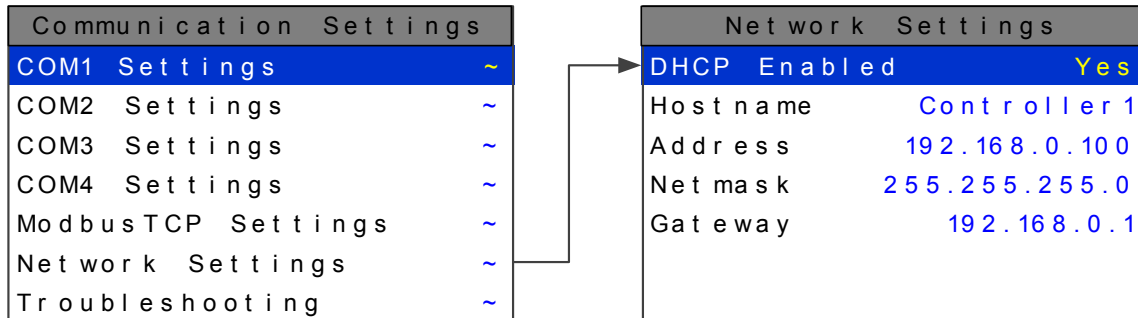

Figure 2-25

#### 2.5.3.1 DHCP ENABLED

Enable this parameter to allow the IP address to be set automatically by an external DHCP server. When this parameter is enabled, the unit can be accessed by its hostname or IP address, although the IP address will be dependent on the DHCP server and could potentially change.

#### 2.5.3.2 HOSTNAME

Hostname identifies the unit on a network as an alternative to the IP address.

#### 2.5.3.3 IP ADDRESS

IP address identifies the unit on a network. This is automatically set when DHCP is enabled.

#### 2.5.3.4 NETMASK

Specify if your network requires. Netmask specifies the subnet addressing scheme. This is automatically set when DHCP is enabled.

#### 2.5.3.5 GATEWAY

Gateway is the IP address of the device that may connect this subnet to other networks. This is automatically set when DHCP is enabled.

## 2.5.4 TROUBLESHOOTING

The **TROUBLESHOOTING** option in the communication settings menu can prove to be very helpful when setting up communications through the ViewSmart 6400's numerous communication ports. This feature allows the user to see how many messages were either corrupt when received or not received at all.

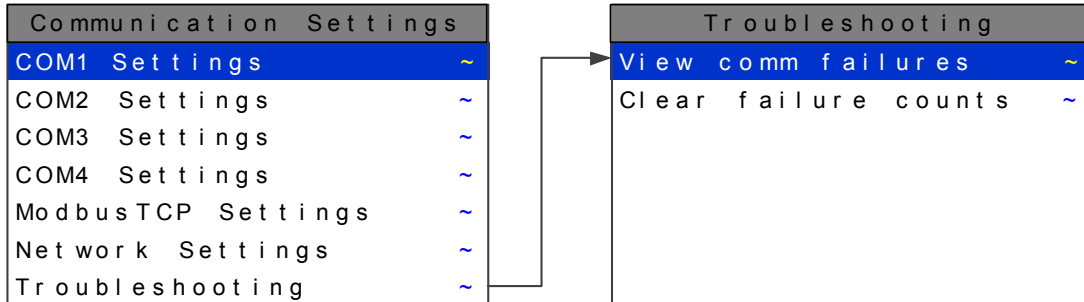

Figure 2-26

### 2.5.4.1 VIEW COMM FAILURES

When **VIEW COMM FAILURES** is selected the screen in Figure 2-27 is shown. Each individual channel is shown and it is color coded by the communication port that it is configured for in its own Data From menu ([see section 2.4.4](#)). If the channel is not configured to receive data from a communication port it is shown in grey. Communication port 1 is shown in cyan (Ch.1-11), communication port 2 in orange (Ch.12-20), communication port 3 in magenta (Ch.21-31), communication port 4 in blue (Ch. 33-41), and the Ethernet port in yellow (Ch. 42-47). The number that is shown after the channel number represents the number of times a query was sent out and either a corrupt message was received or no message was received at all. When troubleshooting a specific channel or communication port a simple test can be ran by resetting this number ([see section 2.5.4.2](#)) and then recording the number of communication failures received after a known amount of time has passes. Make a change to the system and then repeat the test for the same amount of time. Compare the results to see if the change has helped the problem.

Ch . 01 : 4	Ch . 17 : 0	Ch . 33 : 10 6 7	Ch . 4 9
Ch . 02 : 6	Ch . 18 : 0	Ch . 34 : 0	Ch . 5 0
Ch . 03 : 7	Ch . 19 : 0	Ch . 35 : 0	Ch . 5 1
Ch . 04 : 2	Ch . 20 : 0	Ch . 36 : 0	Ch . 5 2
Ch . 05 : 4	Ch . 21 : 2 13	Ch . 37 : 0	Ch . 5 3
Ch . 06 : 3	Ch . 22 : 2 0 0	Ch . 38 : 0	Ch . 5 4
Ch . 07 : 6	Ch . 23 : 2 15	Ch . 39 : 0	Ch . 5 5
Ch . 08 : 7	Ch . 24 : 2 0 4	Ch . 40 : 0	Ch . 5 6
Ch . 09 : 5	Ch . 25 : 2 10	Ch . 41 : 0	Ch . 5 7
Ch . 10 : 3	Ch . 26 : 2 0 9	Ch . 42 : 6 5 8	Ch . 5 8
Ch . 11 : 4	Ch . 27 : 2 18	Ch . 43 : 7 0 0	Ch . 5 9
Ch . 12 : 0	Ch . 28 : 2 16	Ch . 44 : 6 6 8	Ch . 6 0
Ch . 13 : 0	Ch . 29 : 2 11	Ch . 45 : 6 8 7	Ch . 6 1
Ch . 14 : 0	Ch . 30 : 2 0 4	Ch . 46 : 6 9 8	Ch . 6 2
Ch . 15 : 0	Ch . 31 : 2 0 7	Ch . 47 : 6 9 0	Ch . 6 3
Ch . 16 : 0	Ch . 3 2	Ch . 4 8	Ch . 6 4

Comm Port 1	Cyan	Comm Port 4	Blue
Comm Port 2	Orange	Ethernet Port	Yellow
Comm Port 3	Magenta	Channel Off	Grey

Figure 2-27

### 2.5.4.2 CLEAR FAILURE COUNTS

Selecting this option clears the communication failure counter so test can be run or old data can be cleared after communication ports are configured.

## 2.6 SECURITY MENU

A password entered in the **SECURITY** menu allows locking all menus. *Viewing* menus is not denied but attempts to *edit* variables flashes the **Locked** message on the LCD.

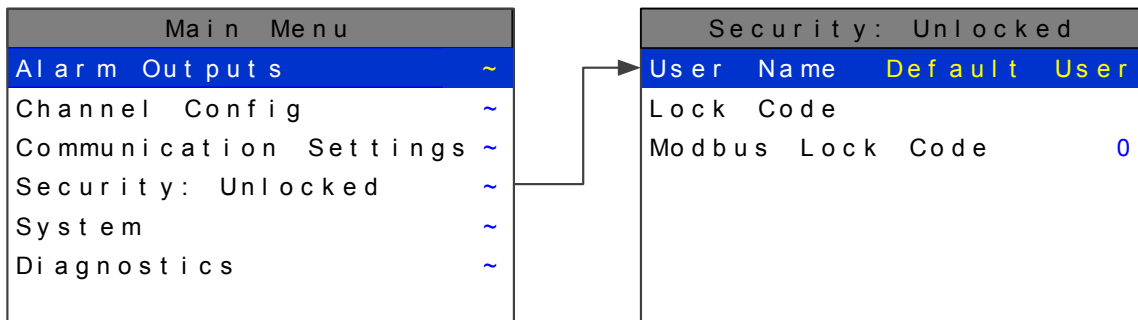

Figure 2-28

### 2.6.1 USER NAME

Authorized individuals locking the system should first enter a name, phone number, or other contact information into the 10 digit field so they can be contacted to unlock the unit at a later date.

### 2.6.2 LOCK CODE

To lock or unlock the system the correct 4 digit authorization number must be entered into the **Lock Code** field. The ViewSmart 6400 will ask this 4 digit code to be re-entered and then it will be lock. Once locked, re-entering the code will unlock the unit.

It is very important to record the 4 digit code. However, if lost the controller may be unlocked by entering the override code: **8621**

### 2.6.3 MODBUS LOCK CODE

The Modbus database is normally locked. The register 40099 is used to unlock the unit and allow writes. When written with the unlock code (found in the security menu). The database unlocks and stays unlocked while writes occur and for 10 minutes of being idle. The default Modbus lock code is "1234".

## 2.7 SYSTEM MENU

The **SYSTEM** menu is accessed through the **MAIN MENU**. Some items needing configuration are not specific to a channel but affect the entire ViewSmart 6400 system. These are located in the system entry menu shown in Figure 2-29. System menus are

accessed by pointing to the desired item and pressing .



### 2.7.1 VERSION

The **VERSION** line in the System menu displays the version of firmware that is programmed in the controller.

System	
Version	v 1.00
Configure	~
Zone Names	~
Mimic Mode	~
SD Card	~
View Event Log	~
Clear Event Log	~
View Sensor Life	~

Figure 2-30

### 2.7.2 CONFIGURE

Some items needing configuration are not specific to a channel but affect the entire ViewSmart 6400 system. These are located in the **CONFIGURE** entry menu shown on the right side of Figure 2-31. System Configuration menus are accessed by pointing to

the desired item and pressing .

System		Configure	
Version	v 1.00	Name	Unit - 72 - 3967
Configure	~	Contrast	50
Zone Names	~	Date	10 / 20 / 2010
Mimic Mode	~	Time	09:43:28
SD Card	~	Enable Channel Count	64
View Event Log	~	Display Alarm	Main Data
Clear Event Log	~	Warmup Time (min)	1
View Sensor Life	~	Cal Purge Time (min)	1
		Zone Screen Enabled	Yes
		Block Negative	Yes
		Relay Refresh (min)	0

Figure 2-31



### 2.7.2.1 NAME

Assign the controller a name for use in the backup configuration file name on the SD card. The controller name is limited to 16 characters.

### 2.7.2.2 CONTRAST

The Configure menu item identified as **CONTRAST** allows users to adjust the LCD contrast to a level suitable to the ambient lighting. Selecting **CONTRAST** and pressing



causes the



keys to increase and decrease LCD contrast.

### 2.7.2.3 DATE & TIME

Adjust the date and time here for use in DATA and EVENT LOGGING. This is a factory setting but may need to be adjusted for the end users location.

### 2.7.2.4 ENABLE CHANNEL COUNT

For applications that do not need **64** channels, the ViewSmart 6400 can be configured to display **16, 32, or 48**. With fewer channels to be displayed in MAIN DATA screen the cells expand for better resolution.

### 2.7.2.5 DISPLAY ALARM

Utilizing the display alarm feature in the System menu allows the ViewSmart 6400 controller to force the LCD to the MAIN DATA or ZONE screens when an alarm level is reached. This proves to be useful if channel or zone must be displayed when in alarm. The MAIN DATA screen is the default alarm screen from the factory.

### 2.7.2.6 WARMUP & CAL PURGE TIME

**WARMUP & CAL PURGE TIME** are available to prevent unwanted alarm trips during these times. This time can be adjusted up to five minutes for sensors that take a long time to warmup or drift back down after a calibration.

### 2.7.2.7 ZONE SCREEN ENABLED

In some applications all points are linked together in one large ZONE so the ZONE screen does not need to be displayed. Turning **ZONE SCREEN ENABLED** to **NO** causes scrolling through the screens to skip the ZONE screen.

### 2.7.2.8 BLOCK NEGATIVE

This setting prevents negative channel values from being displayed. It applies to all channels.

### 2.7.2.9 RELAY REFRESH

**RELAY REFRESH** menu allows reactivation of Acknowledged alarms after the time period expires. This feature is used primarily to restart audible alarm devices after having been silenced by an acknowledge function (via serial port or pressing the Alarm Reset button). An entry of 0 seconds effectively disables the Alarm Refresh function. Maximum of 60 minutes allowed.

### 2.7.3 ZONE NAMES

ZONES 1-8 names can be edited for a quick reference while in the zone screen. These 16 character names show up in the title bar of each zone.

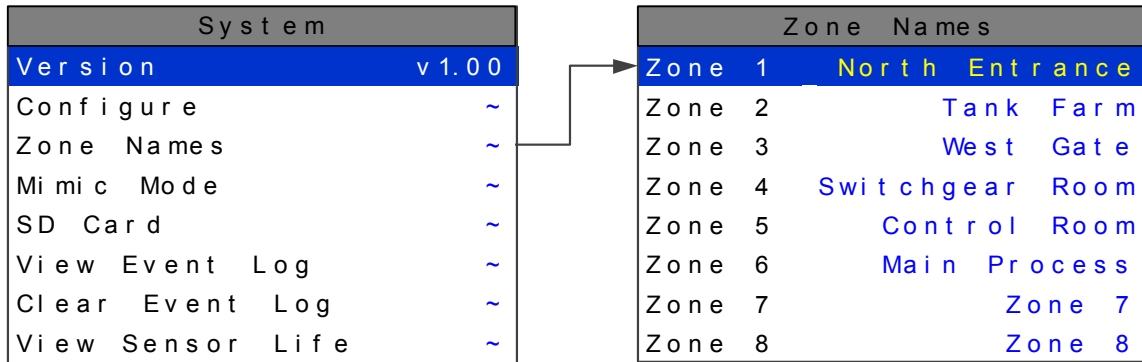

Figure 2-32

### 2.7.4 MIMIC MODE

When mimic mode is enabled, the ViewSmart 6400 will duplicate the data and alarms of another ViewSmart 6400 which can be connected with RS485 or TCP/IP. Entering the communications port and slave ID allows the ViewSmart 6400 to automatically retrieve programmed configuration parameters from the Main controller. The Mimic controller's communication port must be configured as the Modbus Master and the Main controller's communication port is set to Modbus Slave. Once connected the Mimic controller will update automatically one minute after any parameter is changed in the Main controller. Alarm Reset from either controller will acknowledge any relay set to **Acknowledge YES** ([see section 2.3.1.2](#)).

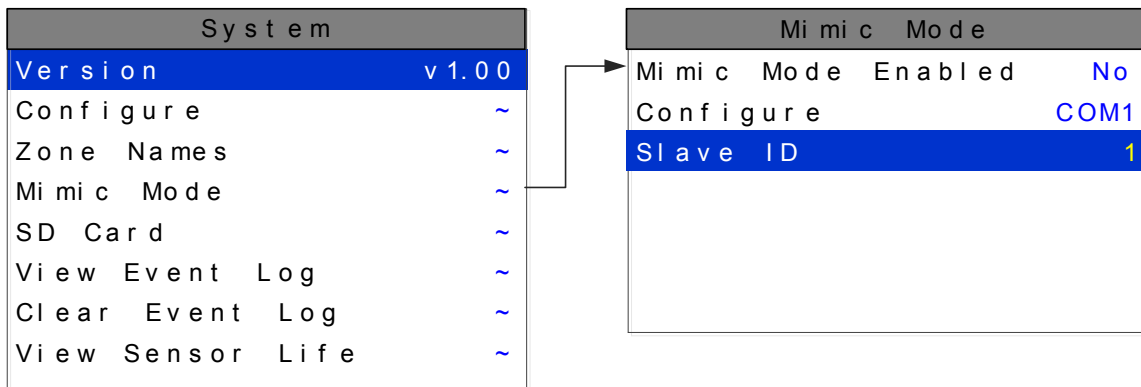

Figure 2-33

## 2.7.5 SD CARD

A two gigabyte SD card comes standard with each ViewSmart 6400. This SD card is not needed for normal operation, but is useful for data logging and backing up configuration.

When the data logger is enabled, every ten minutes the Min, Max, Average, Alarm 1/2/3 status, Fault status, Calibration status, and Alarm reset for each active channel is written to the SD card in one minute intervals. The log files are stored on the SD card by date.

Each day a new file is created and stored in a directory structure as follows:

**UNIT\_NAME\YEAR\MONTH\DAY.csv**. The files are comma delimited text files and work with MS Excel, which can be used to create historical plots of the data.

The first line in the file contains a date stamp. The next line is the header. The header shows the name of each column. The AVG fields in the header list the zero and span values for that channel. The zero and span can be used when creating plots. Another

line exists for each minute of the day. Those lines are time stamped with the hour and minute.

The numeric format of the MIN, MAX, and AVG values are based on channel settings. The decimal precision is the same that is viewed from the unit. This can be adjusted with the decimal points parameter in each channel's Configure menu.

The SD Card can store more than 1 year of historical data, but backups of the card should be performed on occasion. Backing up logs requires removing the SD card and inserting it in a PC that has a card reader interface.

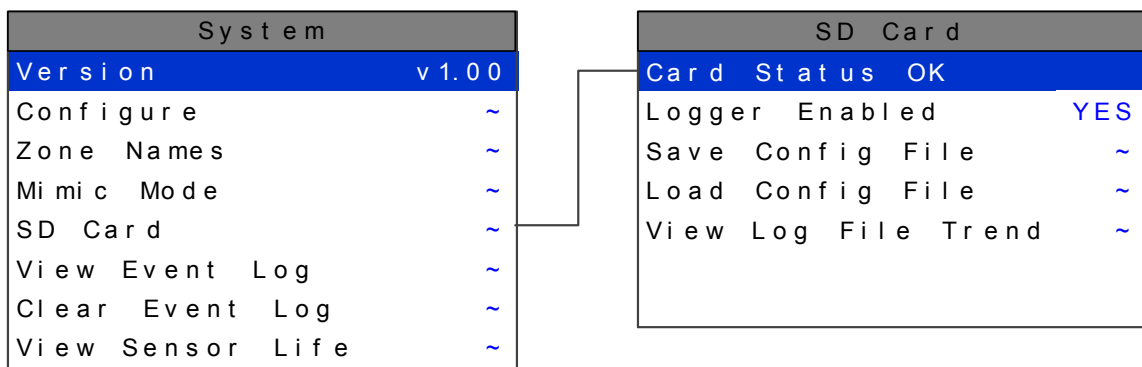

Figure 2-34

### 2.7.5.1 CARD STATUS

When the SD card is properly inserted into the card slot **CARD STATUS** will display **OK**. If the SD card is removed or becomes corrupt the green LED (Figure1-1) will blink continuously and **CARD STATUS** will say **CARD NOT FOUND**.

### 2.7.5.2 LOGGER ENABLED

Enabling the Data Logger allows the ViewSmart 6400 to record the channel data for all active channels.

### 2.7.5.3 SAVE CONFIGURATION FILE

By selecting **SAVE CONFIG FILE** the current configuration file will be backed up on the SD card. This can be beneficial in the event of a board failure or if multiple ViewSmart 6400s must be programmed the same. The filename of the saved will be **UniteNameDDMMYY.cfg** where DDMMYY is the current date. Saving configuration will overwrite previous saves from the same date. It is recommended to backup configuration once a unit is fully configured.



### 2.7.5.4 LOAD CONFIGURATION FILE

Once a file is backed up on the SD card it can be loaded back into the ViewSmart 6400 to change the current configuration to a previous configuration or the SD card can be



moved to another unit and the configuration can be copied to the second unit. This is done by selecting **LOAD CONFIG FILE** then select the name and date of the configuration file that is to be copied.

#### 2.7.5.5 VIEW LOG FILE TREND

**VIEW LOG FILE TREND** displays historic 24 hours of data using the 24 Hour Trend screen format shown in Figure 1-3. The user selects the date to be displayed and all

active channels for that day are loaded into the ViewSmart 6400. Use the / to scroll through the 64 channels of Historic data. The ViewSmart 6400 24 Hour Historic Trend data screen is identified by the cyan background color in the graph area. All alarm processing is active during viewing of historic trend and if a new alarm becomes present a prompt will ask the user if they would like to continue viewing the historic data or exit this mode and view real time readings.

### 2.7.6 VIEW EVENT LOG

The ViewSmart 6400 logs the last 2000 events, first in first out, in non-volatile memory so a SD card is **NOT** necessary to view the event log. The events are time and date stamped and if channel specific the number is shown in the right column. Use  /  to scroll through the events.

The following events are logged: Alarm 1 In, Alarm 1 Out, Alarm 2 In, Alarm 2 Out, Alarm 3 In, Alarm 3 Out, Fault In, Fault Out, Comm Error, Config Error, IO Error, Cal In, Cal Out, System Boot, Cold Boot, Alarm Reset, Remote Alarm Reset, Alarm Refresh, Marker, Configuration Change, and Event Log Cleared.

System		Time	Date	Event	Ch.
Version	v 1.00	09:42	07/13/2010	Alarm 1 out	19
Configure	~	09:30	07/13/2010	Alarm Reset	19
Zone Names	~	09:28	07/13/2010	Alarm 1 in	19
Mimic Mode	~	08:15	07/13/2010	System Boot	--
SD Card	~	21:37	07/12/2010	Alarm 1 out	07
View Event Log	~	21:35	07/12/2010	Alarm 2 out	07
Clear Event Log	~	21:30	07/12/2010	Alarm 2 in	07
View Sensor Life	~	21:28	07/12/2010	Alarm 1 in	07
		17:56	07/09/2010	Comm Error	16
		15:53	07/02/2010	Config Error	22
		11:15	06/12/2010	Cold Boot	--
		09:37	06/01/2010	Cal out	46
		09:30	06/01/2010	Cal in	46
		05:36	05/24/2010	Fault out	32
		05:35	05/24/2010	Fault in	32

Figure 2-35

### 2.7.7 CLEAR EVENT LOG

After initial setup and testing of the controller, **CLEAR EVENT LOG** is used to manually clear all events in the log file. If the event log is not cleared the older events will be pushed out as new ones occur.

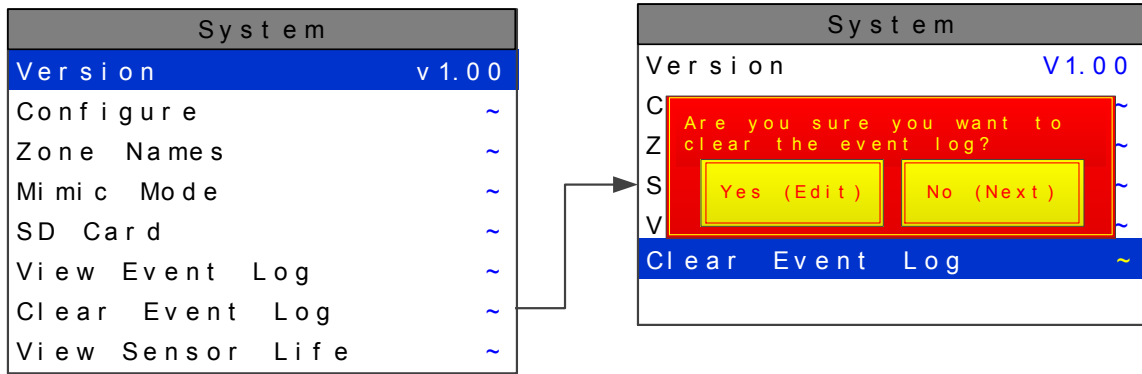

Figure 2-36

### 2.7.8 VIEW SENSOR LIFE

**Sensor Life** is available when at least one channel has **Sensor Life** activated in the **Marker menu** (see section 2.4.4.5). The **Sensor Info** screen displays each channel's sensor status as illustrated in Figure 2-37. Channels with **Sensor Life** disabled are indicated by **Ch. # Disabled** below the bar. **Cal Required** indicates no Calibration Marker value has been received by the ViewSmart 6400.

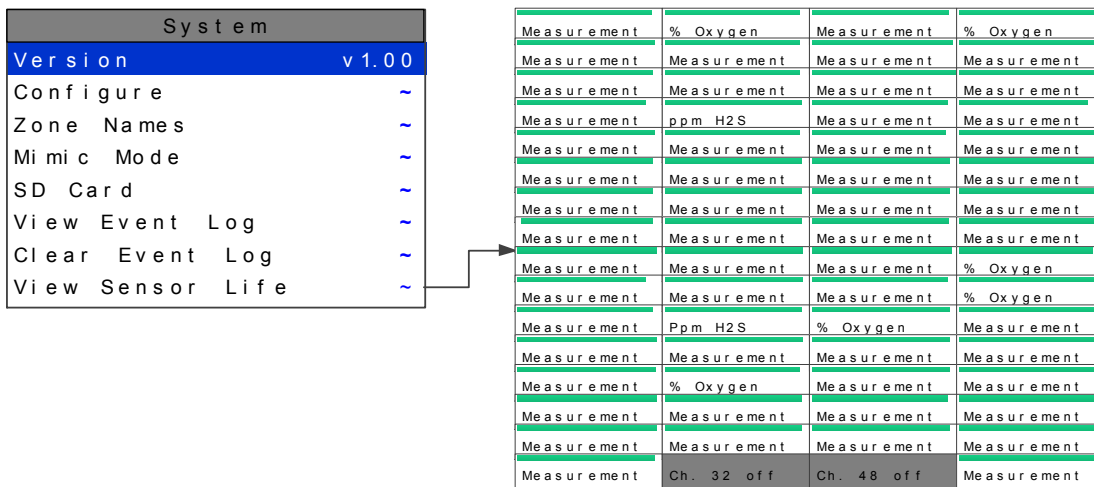

Figure 2-37

## SECTION 3 INPUT/OUTPUT BOARDS

### 3.1 MAIN I/O INTERFACE BOARD # 10-0331



The most basic ViewSmart 6400 Controller requires only the I/O Board shown in Figure 3-1 for interfacing to field wiring. The ViewSmart 6400 primary power supply is applied to terminals 1 & 3(+) and 5 & 7(-) of TB4. This may be from 10 – 30 VDC. **WARNING! HIGH VOLTAGES SUCH AS 115 VAC APPLIED TO THESE TERMINALS MAY CAUSE SEVERE DAMAGE!** DC output terminals 2 & 4(+) and 6 & 8(-) on TB4 provide up to 500mA of fused output power for powering remote devices such as lamps, transmitters etc.

This Board includes two RS-485 ports that can be independently configured either *master* or *slave*, one Ethernet port, five Standard SPDT 5A relays, consisting of one dedicated HORN and FAULT relay plus 3 programmable alarm relays, and power supply I/O terminals. The Ethernet port allows the unit to be a ModbusTCP *Master and Slave* and also provides access to the embedded webpage. The failsafe Fault circuit detects firmware and CPU failures along with transmitter failures. JP1 allows the RS-485 ports to be configured for 2 or 4 wire operation. A 40 pin ribbon cable connects the I/O Board to the ViewSmart 6400 CPU and Display nest assembly. Two I<sup>2</sup>C bus connectors allow addition of optional functions such as analog I/O and discrete alarm relays for each channel.

Horizontal jumpers installed in position 1 at JP1 connect the RS-485 port's RX & TX lines, simplifying 2 wire daisy chains by providing additional terminals for incoming and outgoing cables. For example, installing the two COM 1 jumpers connects screw terminals 1 & 5 and terminals 3 & 7 at TB3. RS-485 terminating resistors R5 (COM 1) and R11 (COM 2) are located on the MAIN I/O Board and installed by moving the jumpers at JP2 to position 1. These resistors should not be installed if the port is not at the end of the communication line.

TB1 of the Main I/O Board allows the ViewSmart 6400 to be acknowledged remotely. A low signal at this input will simulate an Alarm Reset event ([see section 2.3.1.2](#)). The '+' input of TB1 is pulled up to +5V. An external circuit or relay can pull the '+' input low (to the '-' input) to activate the Alarm Reset event. The wiring to the external circuitry should be no longer than 10 feet.

An optional Auxiliary Standard Relay *piggyback* Board (part # 10-0332) may be added to the I/O Board via ribbon cable J3. This option adds another five SPDT 5A relays that mimic the five standard relays. Auxiliary Standard Relay contacts are available at TB1 on the optional 10-0332 shown in Figure 3-1.

An optional RS-485 Isolated *piggyback* Board (part # 10-0368) may be added to the I/O Board via ribbon cable J5. This option adds two additional isolated RS-485 ports for a total of four. These two additional serial ports can also be configured for either Master or Slave. Horizontal jumpers installed in position 1 at JP2 & JP3 (com port 3) and JP5 &



JP6 (com port 4) connects the RS-485 port's RX & TX lines, simplifying 2 wire daisy chains by providing additional terminals for incoming and outgoing cables. For example, installing the two COM 1 jumpers connects screw terminals 1 & 5 and terminals 3 & 7 at TB1. RS-485 terminating resistors are installed by moving the jumpers at JP1 (com port 3) and JP4 (com port 4) to position 1. These resistors should not be installed if the port is not at the end of the communication line.

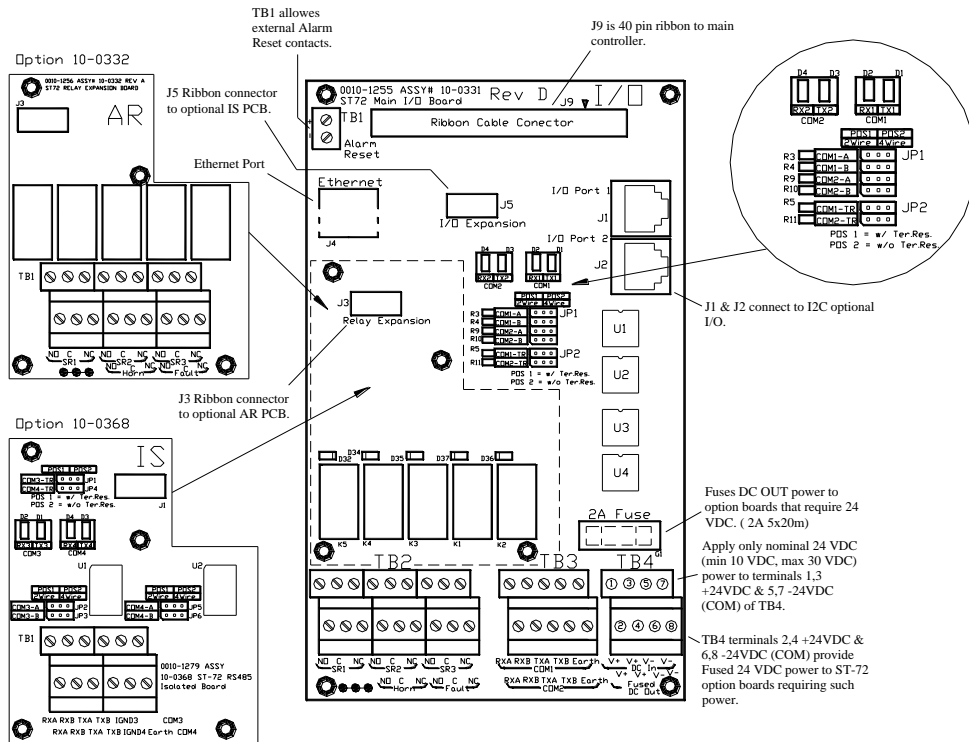

Figure 3-1

Main I/O Board

### 3.2 INPUT / OUTPUT OPTION BOARDS

Telephone style RJ11 connections (J3 and J4 on all option Boards) are used to add optional 16 channel analog and digital I/O. All option Boards must have 24 VDC applied to TB3 or TB4 which are tied together making daisy chaining the 24 VDC from one option board to another possible. All I/O options except the Programmable Relay Board have LEDs to indicate which channel and alarm they are assigned to. The Programmable Relay is not limited to groups of 16 channels like the other options so the LEDs are not required. The connected I/O screen in the *Diagnostics Menu* is also useful for displaying and programming the connected I/O Boards.

### 3.2.1 OPTIONAL ANALOG INPUT BOARD # 10-0334



**In compliance with CSA C22.2 No. 152 certification, the 4-20 ma input does not include or imply approval of the LEL gas detection apparatus such as sensors, transmitters, or devices connected to the system. In order to maintain CSA Certification of the system, all 4-20 ma gas detection instruments connected to the input must also be CSA Certified.**

Many transmitters or sensors have analog output signals and the 12 bit *Analog Input* Board, shown in Figure 3-2, is available to accept these. TB1 and TB2 with 24 positions each, offers 3 terminals per channel for distributing power and receiving analog inputs. These are **EXC** and **HI / LO** inputs. TB3 and TB4 with only two positions each, is for daisy chaining the power supply from one option board to another. When the transmitters are hi power three wire units it is recommended this power be supplied to each option board with its own pair of wires connected directly to the DC power supply. Precision 150 ohm 5 watt resistors (R1 – R16) between each channel's **IN LO** and **IN HI** terminals are termination resistors for 4-20mA inputs.

**EXC** and **IN LO** terminals are bussed together internally. **EXC** terminals are tied directly to TB3 and TB4 +24 VDC and **IN LO** terminals are tied to TB3 and TB4 power supply common. Bussing allows transmitter power to be brought into the system at a single point (TB3 or TB4) and distributed back out at each channel's **EXC / IN LO** terminals to simplify field wiring. Figure 3-2 includes typical wiring to 2 & 3 wire 4-20mA transmitters.

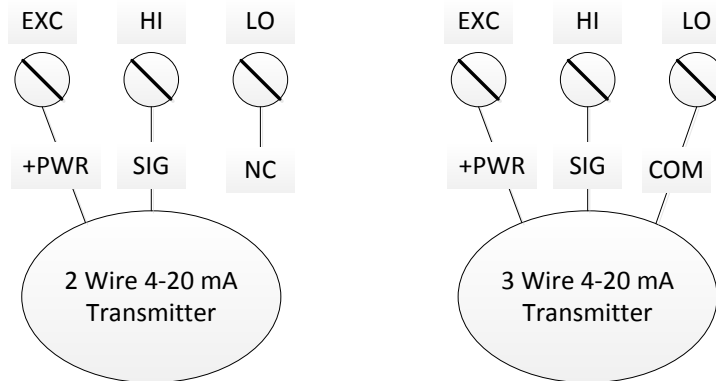
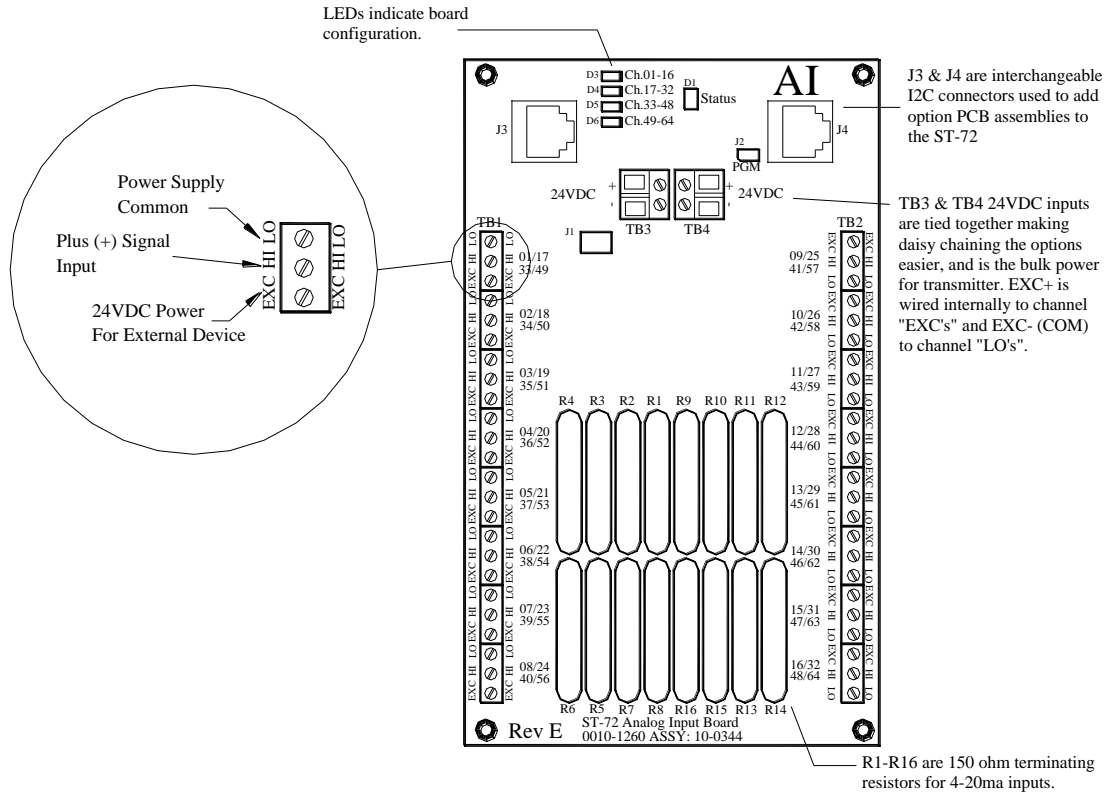

Figure 3-2

### 3.2.2 OPTIONAL DISCRETE RELAY BOARD # 10-0345

An optional *Discrete Relay Board*, shown in Figure 3-3, adds sixteen 5 amp (resistive) form C relays per sixteen channel alarm board. Each BOARD may be configured via Diagnostics Menu in the ViewSmart 6400 for ALARM 1, ALARM 2, ALARM 3 or FAULT for channels 1-16, 17-32, 33-48 or 49-64. Each relay has a LED associated with it indicating whether the relay is energized. An illuminated LED indicates energized. Alarm groups, or zones, may be created by connecting adjacent channels together using JP5 as shown. This creates an *OR* function with selected channels, causing *any* alarm included within the zone to actuate *ALL* zoned relays. *Failsafe* operation of 10-0345 discrete relays may be programmed in the *system configuration* menu as described in [section 2.3.3](#). Many ViewSmart 6400 applications utilize the five standard alarm relays ([see section 3.0](#)) and sixteen optional programmable relay board, and do not require discrete relays for each of the 64 alarm events (64 A1s, 64 A2s, 64 A3s & 64 Faults). If discrete relays are needed for all 64 alarms, then sixteen boards are required. Each 10-0345 is powered with 24 VDC at TB3 and TB4.

TB5 provides an open collector failure detection output. If communication is lost with the CPU board or if the relay board's processor fails, the positive terminal of TB5 is pulled low.



All relays are rated at 5 Amp for 28 VDC and 250 ~VAC **RESISTIVE** loads. **IMPORTANT:** Appropriate diode (DC loads) or MOV (AC loads) snubber devices must be installed with inductive loads to prevent RFI noise spikes. Relay wiring should be kept separate from low level signal wiring.

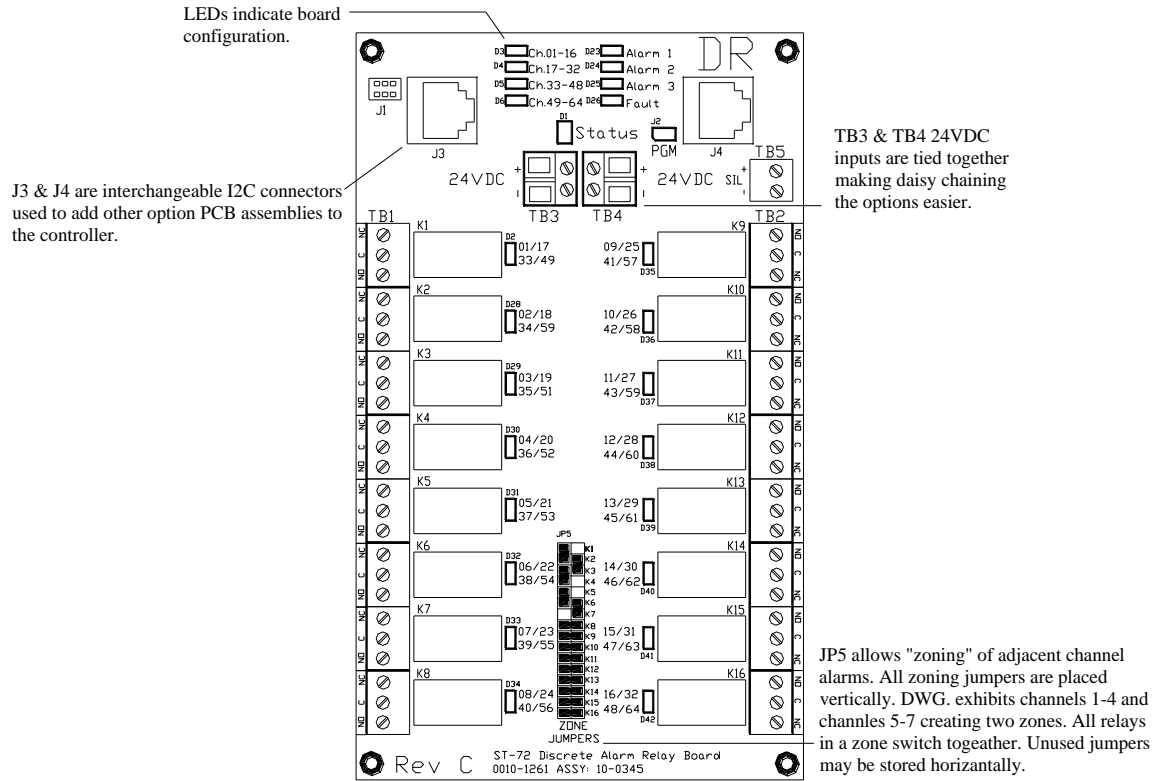

Figure 3-3

### 3.2.3 OPTIONAL \*BRIDGE SENSOR INPUT BOARD #10-0347

An optional 16-channel, 12 bit *Bridge Sensor Input board* allows popular gas detectors to be connected directly to the ViewSmart 6400 without additional signal conditioning or transmitters. Up to eight dual channel 10-0192 modules may be installed in each 16-channel 10-0347. Each 10-0192 channel is equipped with a bridge amplifier and balance potentiometer and an adjustable switching regulator for setting the correct sensor excitation voltage. A three position coarse gain jumper allows setting the gain of the bridge amplifier. Fault supervision circuitry forces the ViewSmart 6400 into a FAULT condition upon sensor failure or removal.

This option may also be configured to accept 4-20mA inputs for mixing bridge sensors and current loops into the same board. Placing any channel's 2 position Bridge/4-20mA jumper into 4-20mA position and installing the associated precision 100 ohm socketed resistor allows 4-20mA signals to be applied to its C & A terminals. The 10-0192 sensor modules are not required for channels accepting 4-20mA.

Channels receiving input data from this board should have the *Data From:* menu set for *Analog Input*, as described in [section 2.4.4](#). The board default activates *Cal Mode* described in [section 2.4.4.4](#) needed to *zero* and *span* sensor readings. After performing

the one time only *Initial Setup* as described below, all subsequent calibrations are by the ViewSmart 6400's electronic Cal Mode menus.

\*Catalytic sensors connected directly to the ViewSmart 6400 should be limited to ranges of 0-1000ppm.

### 3.2.4 BRIDGE SENSOR INPUT BOARD INITIAL SETUP

Catalytic bead sensors vary widely in power requirements and sensitivity. It is therefore important to configure each channel to match the sensor with which it will operate.

1. Prior to connecting sensors, apply power to the system. Note this board requires 24VDC power be connected to its TB3 or TB4 terminals 1 & 2 as shown in Figure 3-4. Measure the voltage between each channel's A and R terminals and set the *Voltage Adjust* potentiometers for the correct sensor excitation voltage. This may range from 1.5 volts to 7.5 volts depending upon sensor specifications.



- Sensors may be damaged by accidental over voltage conditions. It is recommended the *Voltage Adjust* potentiometer screws be covered by a dollop of RTV or similar material after completion of this procedure to avoid accidental over voltage conditions.**
2. Remove system power and connect sensor wires to the R-C-A terminals. Reapply system power and confirm correct voltage across each sensor's A & R terminals. Note: If sensor wires are long, it may be necessary to measure the excitation voltage at the sensor end to compensate for  $I^2R$  losses in the wiring.
  3. With the minus voltmeter lead on TB3 common, connect the plus lead to the channel's red test point. With zero air on that sensor, adjust its *Balance* potentiometer for .4 volts at the test point.
  4. Apply 50% span gas to the sensor and allow the test point voltage to stabilize. Two volts = 100% input to the A – D Converter and .4 volts = 0%. Therefore, 1.2 volts = 50%. Place the 3 position *Coarse Gain* jumper into the position which reads between .8 volts and 1.2 volts on the test point with 50% gas on the sensor. Gain settings for each jumper position are as follows: no jumper = 1, LOW = 7, MED = 21, HI = 41. Multiple jumpers have an additive affect upon gain, so the LOW and MED jumpers together provide a gain of 28.

Initial setup is now complete and normally only requires repeating if a sensor is replaced. Final calibration of this channel may now be performed using the ViewSmart 6400's electronic Cal Mode feature described in [section 2.4.4.4](#).

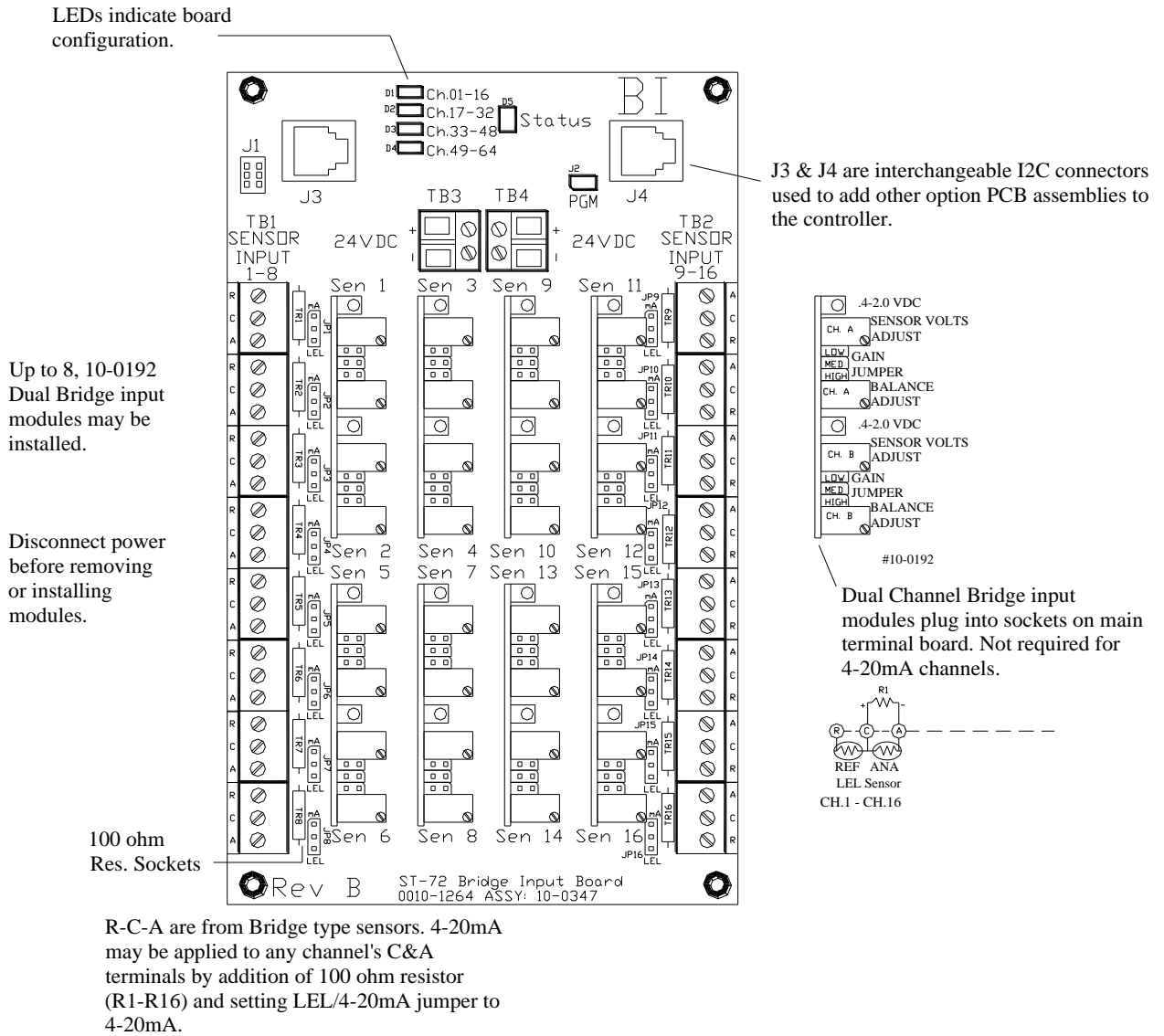

Figure 3-4

### 3.2.5 OPTIONAL 4-20mA ANALOG OUTPUT BOARD #10-0348

An optional 16 bit 4-20mA analog output board, shown in Figure 3-5, may be connected to the I<sup>2</sup>C bus. Each channel's output will transmit 4mA for 0% readings and 20mA for 100% readings. Loop drive capability depends upon the level of the ViewSmart 6400's primary DC power supply. With at least 20 volts DC primary power they are capable of driving 20mA through a 750 ohm load. Outputs are self powered and DC power should not be provided by the receiving device. Note: This board requires nominal 24VDC

power be connected to TB3 or TB4 terminals as shown in Figure 3-5. Since the board has 16 channels, four are required for 64 channel applications.

The analog output board has a failure detection circuit. If the output board's processor fails, or if communication is lost with the CPU board, then the outputs of all channels go to 0mA.

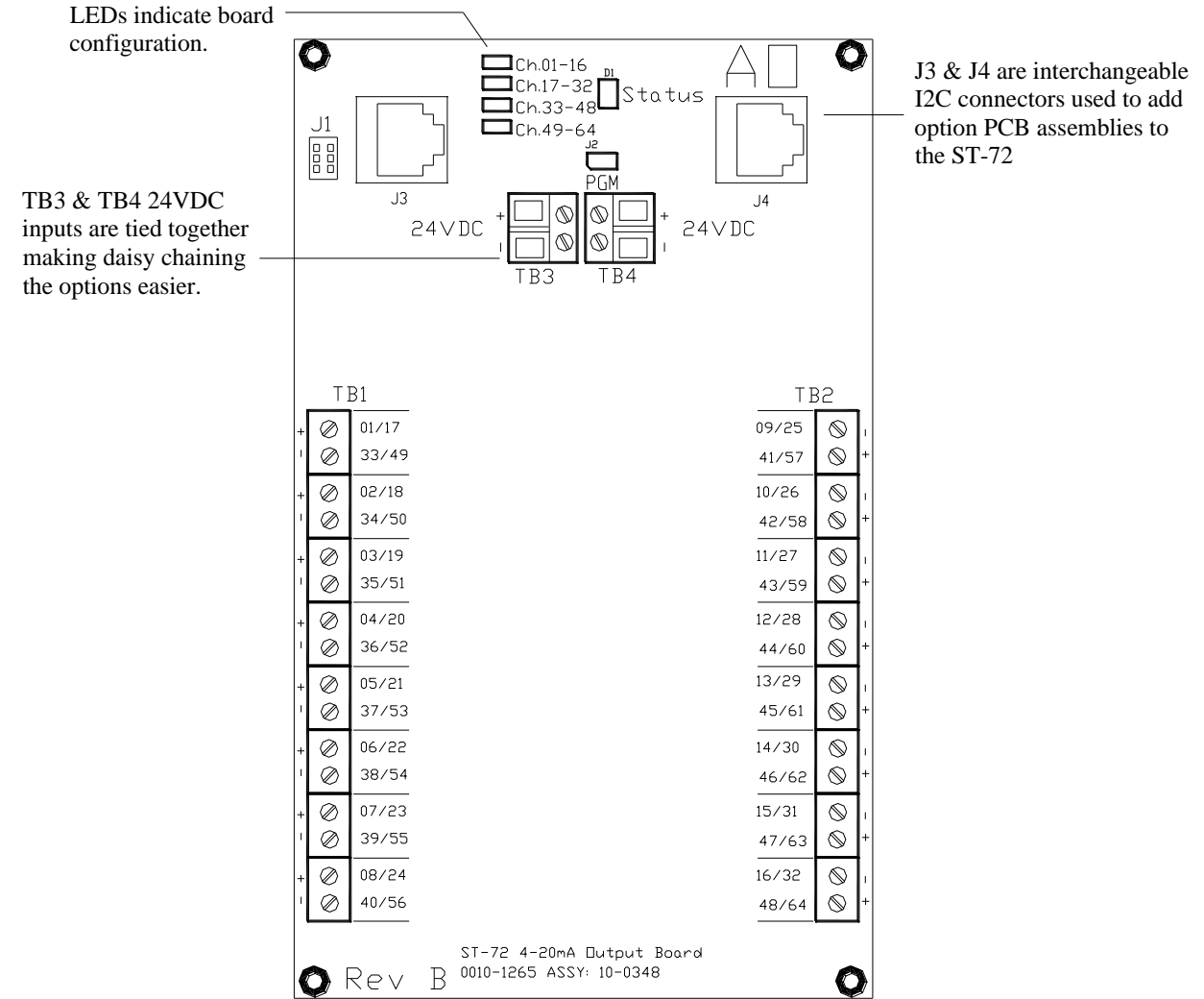

Figure 3-5

### 3.2.6 OPTIONAL PROGRAMMABLE RELAY BOARD # 10-0350

An optional *Programmable Relay Board*, shown in Figure 3-6, adds 16 programmable 5 amp (resistive) form C relays per 16 channel alarm board. Each relay may be configured via the Alarm Outputs Menu in the ViewSmart 6400 Main Menu for ALARM 1 VOTES,



ALARM 2 VOTES, ALARM 3 VOTES, ACKNOWLEDGE, FAILSAFE, ZONES and OVERRIDES. Each relay can be individually programmed for any channel or combination of channels using the zone and override parameters. Many ViewSmart 6400 applications need more than the five standard relays that are provided on the Main I/O Board, but do not need a separate relay contact for each channel. The Programmable Relay Board is a viable cost effective option. It gives the flexibility of an additional 16 fully programmable relays.

Each 10-0350 is powered with 24 VDC at TB3 and TB4. Each relay has a LED associated with it indicating whether the relay is energized. An illuminated LED indicates energized relays.

TB5 provides an open collector failure detection output. If communication is lost with the CPU board or if the relay board's processor fails, the positive terminal of TB5 is pulled low.

All relays are rated at 5 Amp for 28 VDC and 250 ~VAC **RESISTIVE** loads.

**IMPORTANT:** Appropriate diode (DC loads) or MOV (AC loads) snubber devices must



be installed with inductive loads to prevent RFI noise spikes. Relay wiring should be kept separate from low level signal wiring.

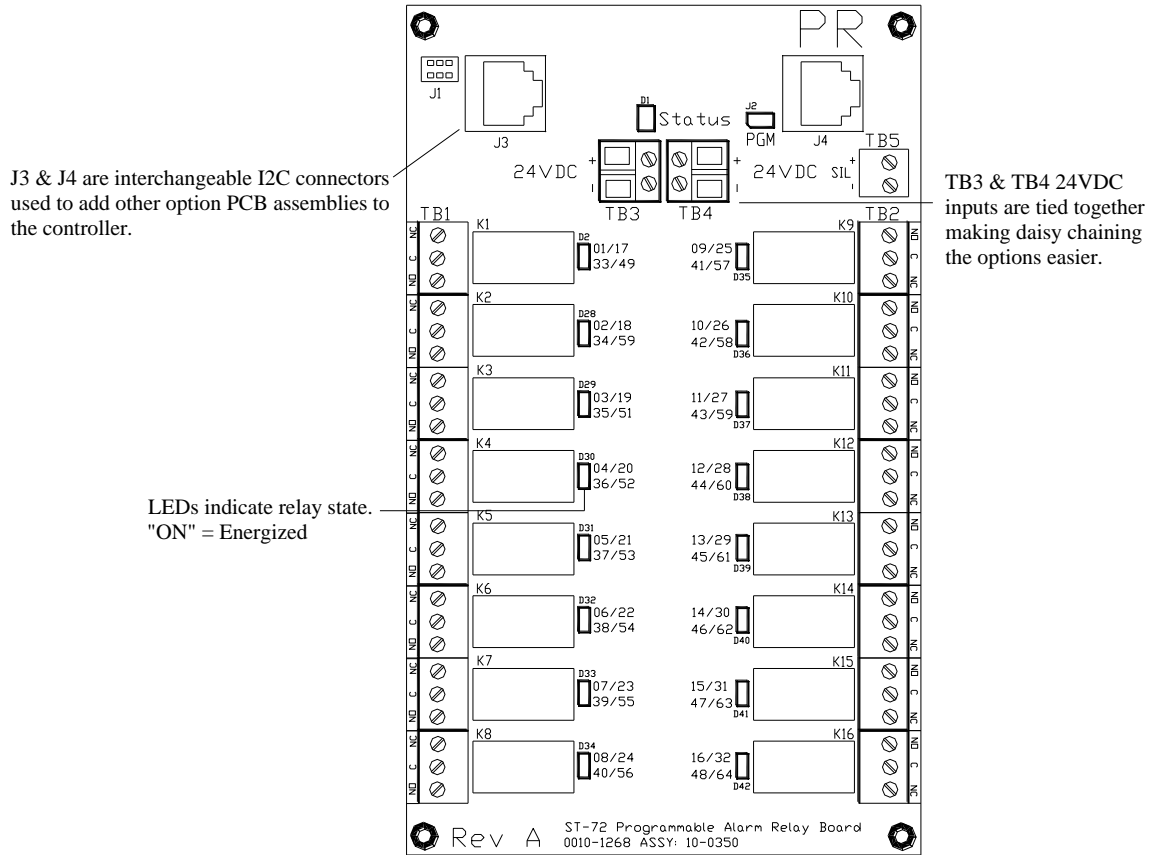

Figure 3-6

### 3.2.7 OPTIONAL 24VDC 600 WATT POWER SUPPLY

The ViewSmart 6400 Controller may be powered from 10-30VDC. However, many applications require 24VDC power for the monitors or transmitters providing inputs to the ViewSmart 6400. A 600 watt AC / DC power supply may be included for these applications (115VAC or 230VAC). When ordered from the factory, it is pre-wired to provide 24VDC primary power for the ViewSmart 6400 controller as well as any transmitters or monitors that may be connected by the end user.

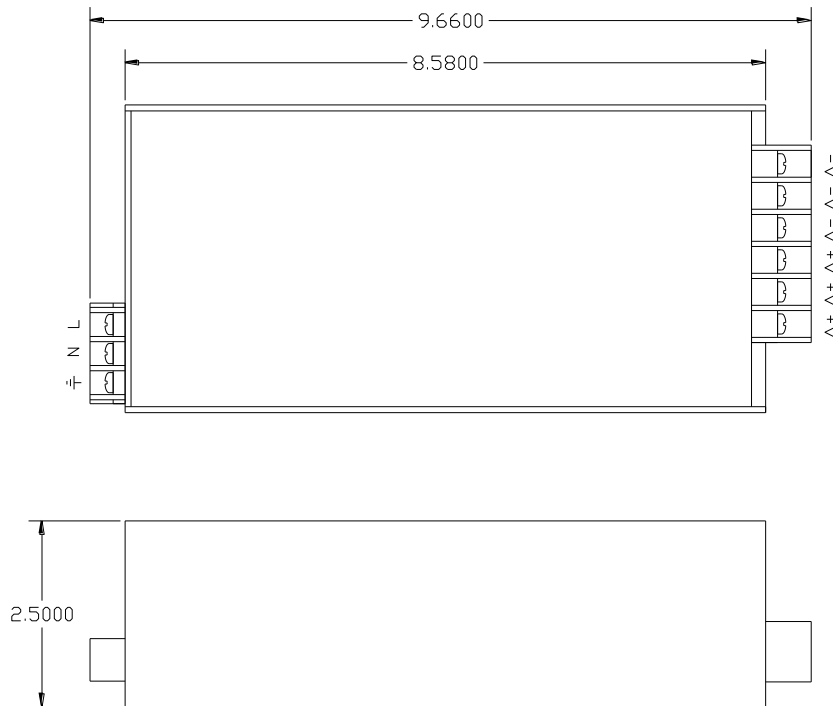

Figure 3-7

600 Watt 24VDC Power Supply

### 3.2.8 OPTIONAL 24VDC 150 WATT POWER SUPPLY #10-0172

The ViewSmart 6400 Controller may be powered from 10-30VDC. However, many applications require 24VDC power for the monitors or transmitters providing inputs to the ViewSmart 6400. A 150 watt AC / DC power supply may be included for these applications (115VAC or 230 VAC selected via slide switch). When ordered from the factory, it is pre-wired to provide 24VDC primary power for the ViewSmart 6400

controller as well as any transmitters or monitors that may be connected by the end user.

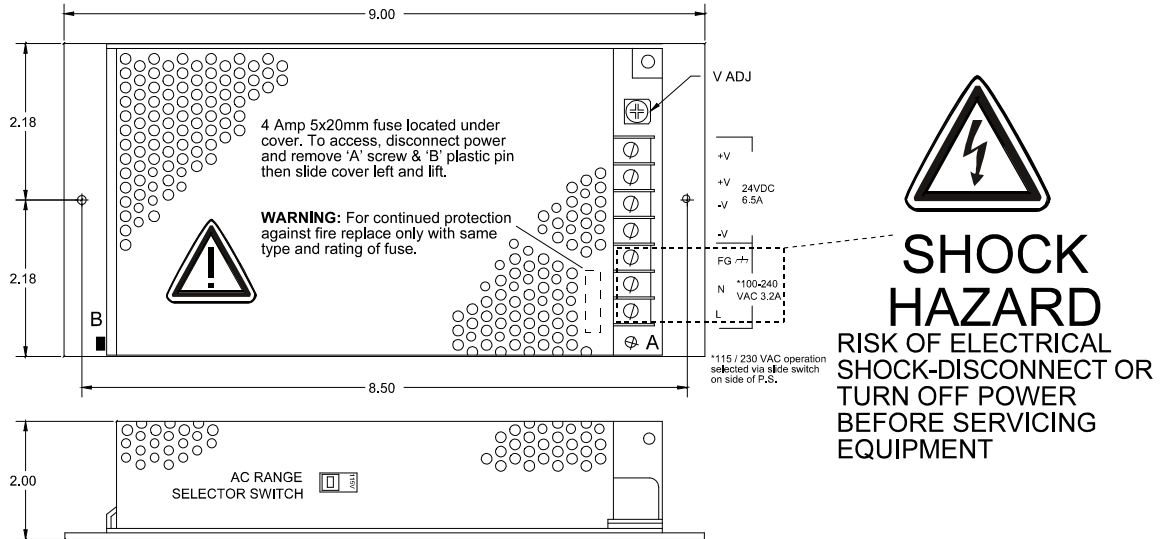

**150 Watt 24 VDC Power Supply Option # 10-0172**

**Figure 3-8**

### 3.2.9 OPTIONAL 24VDC 150 WATT POWER SUPPLY #10-0673

The ViewSmart 6400 Controller may be powered from 10-30VDC. However, many applications require 24VDC power for the monitors or transmitters providing inputs to the ViewSmart 6400. A 150 watt AC / DC power supply may be included for these applications (100-240 VAC auto-ranging). When ordered from the factory, it is pre-wired to provide 24VDC primary power for the ViewSmart 6400 controller as well as any transmitters or monitors that may be connected by the end user.

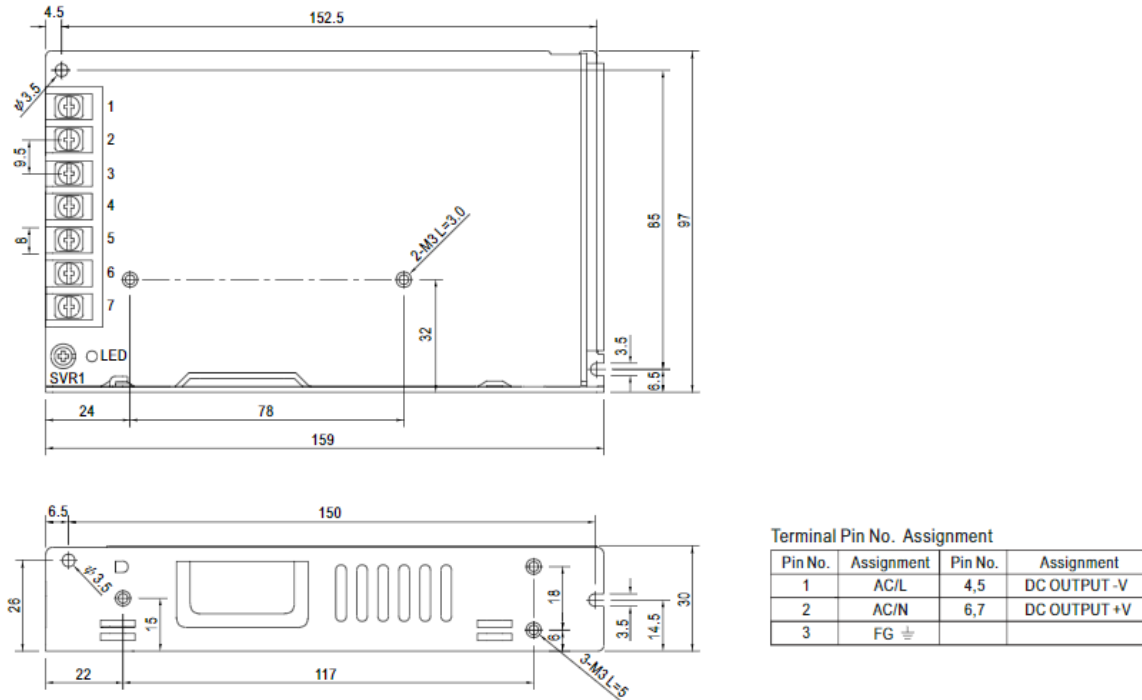



Figure 3-9 Optional 10-0673 150W 24VDC Power Supply Dimensions

## SECTION 4 DIAGNOSTICS

A *System Diagnostic Mode* shown in Figure 2-5 - Figure 2-7 may be entered during normal operation from the MAIN menu. The entry menu, shown below, offers useful routines for testing front panel LED's, relays, serial ports and analog I/O. It is exited

 manually by pressing  and automatically if no keys are pressed for 5 minutes. The unit will reboot when diagnostics is exited. It is very important to understand that **CHANNEL INPUT DATA IS NOT PROCESSED DURING THE DIAGNOSTICS MODE**. It is possible to miss important input values while utilizing this mode and appropriate safeguards should be in place. However, the Diagnostics Mode can prove invaluable when testing I/O since relays and analog outputs may be stimulated without driving inputs to precise levels.

### 4.1 STANDARD RELAYS

**STANDARD RELAY** allows manual actuation of the Standard Relays while in the

Diagnostic mode. Highlight the relay to be actuated and press  LEDs on the Main I/O board confirm relay actuation.

Standard Relay	
Standard Relay 1	Off
Standard Relay 2	Off
Standard Relay 3	Off
Fault Relay	Off
Horn Relay	Off

Figure 4-1

### 4.2 DISCRETE RELAYS

**DISCRETE RELAYS** allows manual actuation of the connected Discrete Relays while in the Diagnostic mode. Highlight the channel group to be actuated and press .

Then select the alarm group and press . These steps bring you to the screen on the right in Figure4-2 and allow the actuation of each relay in the group to be activated individually. LEDs on the Discrete Relay board confirm relay actuation.

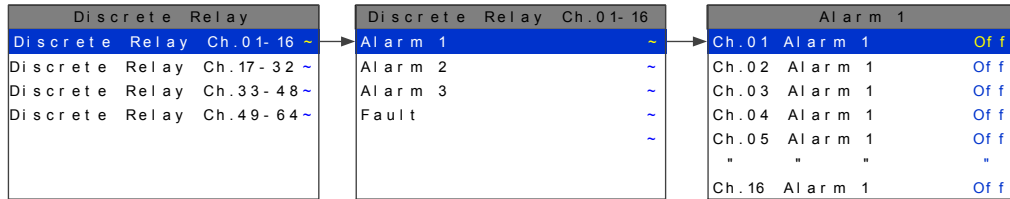



Figure4-2

### 4.3 PROGRAMMABLE RELAYS

**PROGRAMMABLE RELAY** allows manual actuation of the Programmable Relays

while in the Diagnostic mode. Highlight the relay to be actuated and press  LEDs on the Programmable Relay board confirm relay actuation.

Programmable		
Programmable	Rly.01	Of f
Programmable	Rly.02	Of f
Programmable	Rly.03	Of f
Programmable	Rly.04	Of f
Programmable	Rly.05	Of f
"	"	"
Programmable	Rly.16	Of f

Figure 4-3

## 4.4 ANALOG INPUTS

By selecting a channel group you can **VIEW INPUTS** or **CALIBRATE BOARD**.

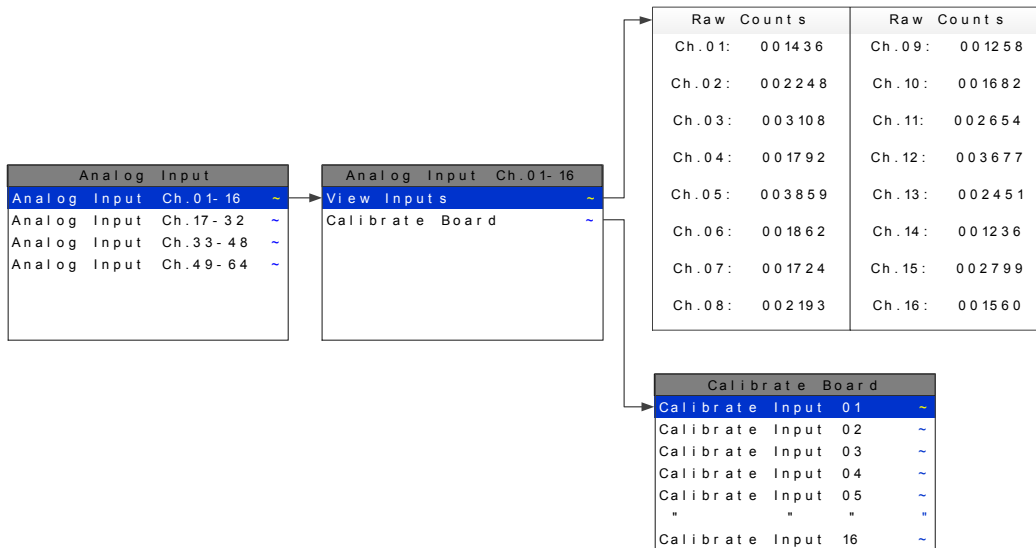

Figure 4-4

### 4.4.1 VIEW INPUTS

The channel inputs are displayed as raw counts and can be useful for trouble shooting. These counts have no calibration applied to them so the user can see if a particular channel's Analog to Digital counts.

### 4.4.2 CALIBRATE BOARD

Initial calibrating of each analog input channel is done at the factory by selecting each channel, one at a time, and applying 20mA. The analog input board self adjust its output and stored this value in non volatile memory.



### 4.5 ANALOG OUTPUTS

If the ViewSmart 6400 is equipped with an analog output option board the output can be manually stimulated by selecting the channel group then the channel to be ramped up. Pressing the  increases the output value in 4mA increments from 0mA to 20mA.

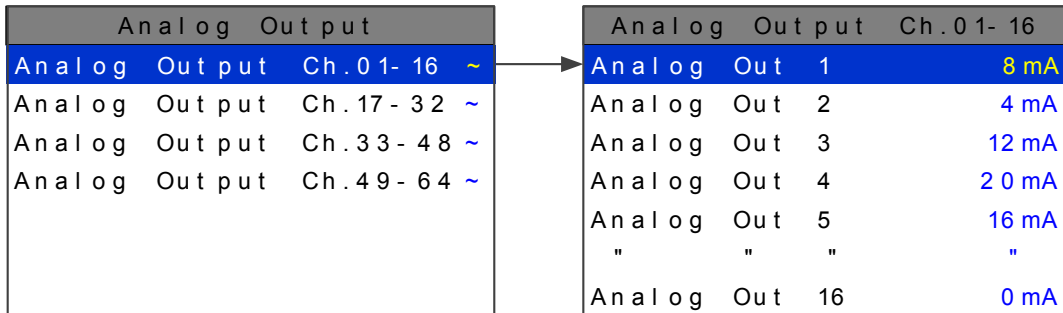

Figure 4-5

### 4.6 PIEZO

Selecting **PIEZO** pulses the controller's local Piezo buzzer.



Figure 4-6

## 4.7 LEDS

Selecting LEDs from the diagnostics menu causes the six LEDs on the front panel to blink without affecting their corresponding relays. All six relay will cycle individually as indicated on the screen.

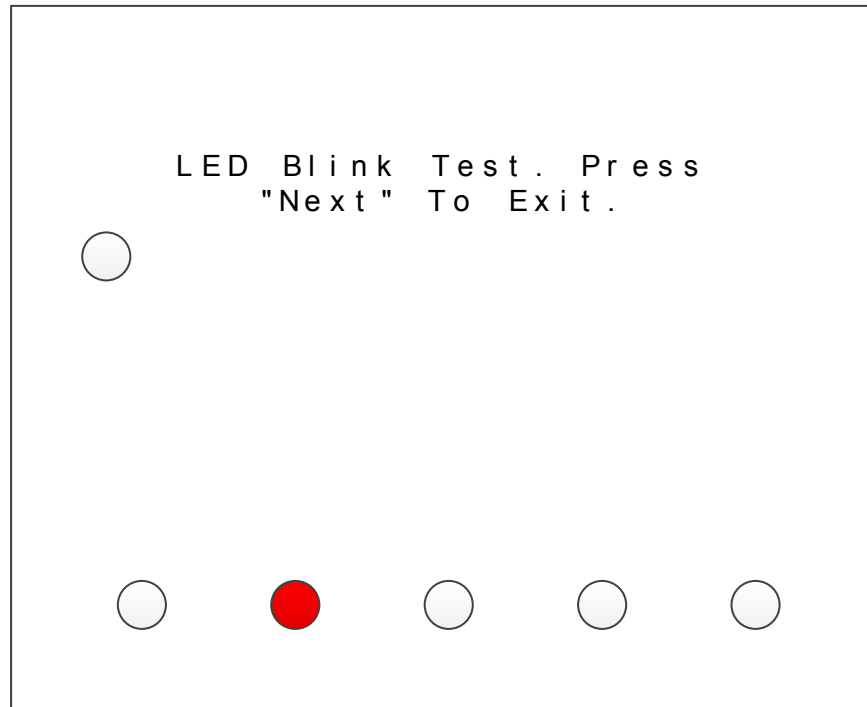

Figure 4-7

## 4.8 SERIAL PORTS

Testing the controllers 2 standard and 2 optional communication ports is made easy by connecting the ports together as shown in Figure 4-8 and selecting **SERIAL PORTS** in the diagnostic menu. The controller does a self diagnostic by polling one communication port with the other to ensure correct operation. It gives a **SUCCESS** or

**FAILURE** report. If the optional communication ports 3 and 4 are not installed they will show a failure as illustrated in Figure 4-8.

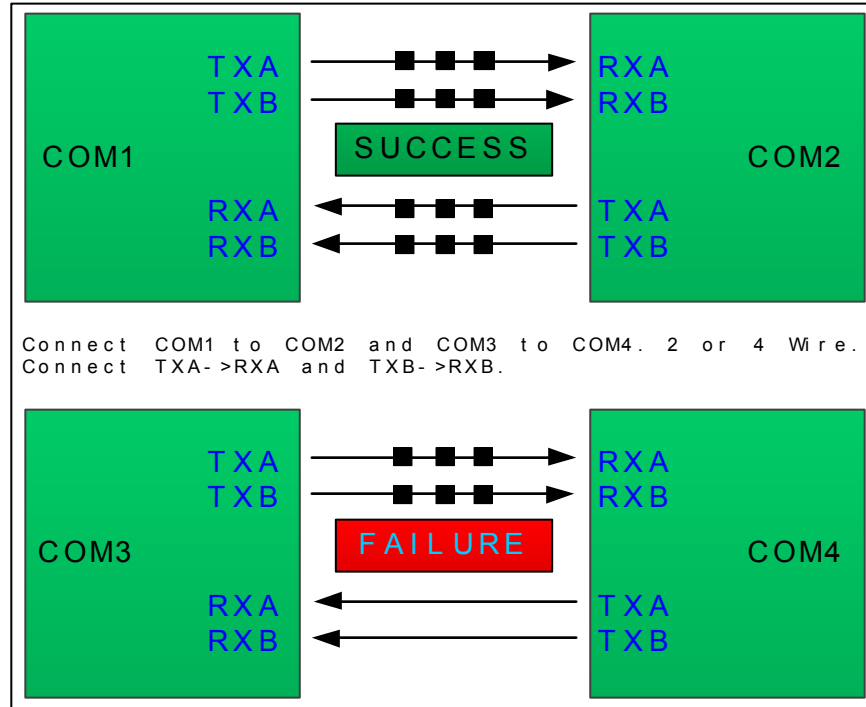

Figure 4-8

### 4.9 I/O BOARD CONFIGURATION

The board configuration screen shows all connected I/O options. This is also the menu where the user must go if they want to change the configuration or channel group of an option board. To change the configuration of an option board first go to the I/O Board configuration screen. All the connected I/O boards are displayed. Second remove the PGM jumper J2 on the option board you want to configure. A box will be displayed as

show below in Figure 4-9. Use / to select the parameter to be changed and

press the to toggle through the options. Third replace the PGM jumper J2, once the correct configuration is selected. The box will disappear once the jumper is reinstalled.

These three steps can be repeated for as many options as necessary, but only one PGM jumper J2 can be removed at a time.

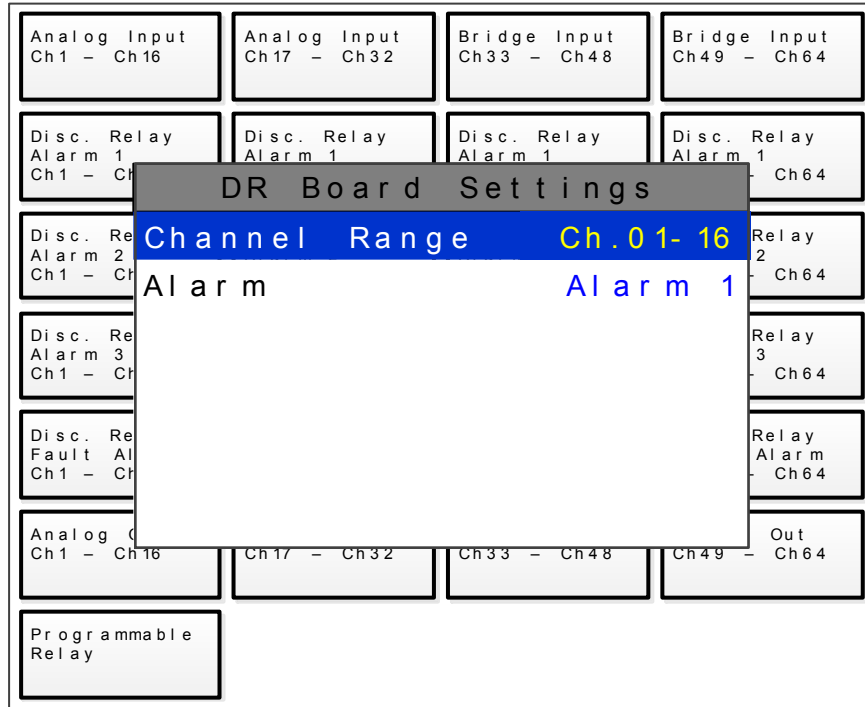

Figure 4-9

## SECTION 5 MODBUS



**In compliance with CSA C22.2 No. 152 certification, the Wireless / MODBUS interface to a LEL gas detector may only be used for data collection or record keeping with regard to combustible gas detection and not for performance verification.**

The ViewSmart 6400 is equipped with two standard RS-485 ports that can be independently configured as Modbus *master* or *slave*, an optional RS-485 Isolated *piggyback* Board (part # 10-0368) may be added to the I/O Board via ribbon cable J5. This option adds two additional isolated RS-485 ports for a total of four. These two additional serial ports can also be configured for either Master or Slave. Section 5.0 defines register locations of data available via the ViewSmart 6400 slave port.

### 5.1 MODBUS TCP

In addition to the RS-485 ports, the ViewSmart 6400 supports both *master* and *slave* ModbusTCP. ModbusTCP is always enabled through the Ethernet port. [See section 2.5](#) for Modbus configuration options. The ModbusTCP slave is always active on port 502. The unit can be polled by its IP Address or hostname. When ModbusTCP slave is used, the slave ID field of the message is ignored. Channels can be configured to poll using the ViewSmart 6400's ModbusTCP master interface. Devices are polled by IP Address, not hostname.

### 5.2 MODBUS SLAVE WRITES

The Modbus slave ports allow function code 5 (write coil), as well as function code 6, and 16 (write holding registers). These function codes can be used to write configuration parameters to the ViewSmart 6400. By default, all Modbus writes are disabled except the unlock parameter 40099. The Modbus lock code can be written to register 40099 to enable writes to other registers. The unit will be unlocked for 10 minutes after the last write occurs. After the 10 minute timeout, the unit will automatically save any parameters that have been written. All written parameters can be saved manually by writing a value of 1 to coil 95 or register 40095.

Writing parameters that span multiple registers (such as 32bit floating points) requires function code 16. All of the registers must be written at once.

### 5.3 MODBUS SLAVE REGISTER LOCATION

The following tables describe the ViewSmart 6400's Modbus slave database. Any portion of this data may be read by a Modbus master device such as a PC, PLC or DCS. Since the Modbus port is RS-485, many ViewSmart 6400s may be multi-dropped onto the same cable.

### 5.3.1 COILS

All coils are duplicated in the holding register table. These values can be read or written using either the coil register or the holding register.

Actions							
Alarm Reset	N/A	1	1	N/A	1	5	Write 1 to simulate pressing the alarm reset button
Save Config	N/A	95	95	N/A	1	5	Saves configuration now
Config Changed	N/A	96	96	N/A	1	5	This register is set to 1 when a configuration parameter has changed. The user can clear it by writing 0.

### 5.3.2 DISCRETE INPUTS

All discrete inputs are duplicated in the input register table. These values can be read using either discrete register or the holding register.

Type	Channel	First	Last	Block Size	Read FC	Write FC	Notes
Lock Status	N/A	12005	12005	N/A	2	N/A	Indicates the lock state for Modbus writes. Locked = 1 Unlocked = 0
Standard Relay 1 State	N/A	12020	12020	N/A	2	N/A	Off = 0, On = 1, doesn't take into account failsafe
Standard Relay 2 State	N/A	12021	12021	N/A	2	N/A	Off = 0, On = 1, doesn't take into account failsafe
Standard Relay 3 State	N/A	12022	12022	N/A	2	N/A	Off = 0, On = 1, doesn't take into account failsafe
Fault Relay State	N/A	12023	12023	N/A	2	N/A	Off = 0, On = 1, doesn't take into account failsafe

Horn Relay State	N/A	12024	12024	N/A	2	N/A	Off = 0, On = 1, doesn't take into account failsafe
Warmup	N/A	12025	12025	N/A	2	N/A	Not in warmup = 0 In warmup = 1
Standard Relay 1 Flashing	N/A	12026	12020	N/A	4	N/A	False = 0, True = 1. Indicates whether standard relay 1 has been acknowledged.
Standard Relay 2 Flashing	N/A	12027	12027	N/A	4	N/A	False = 0, True = 1. Indicates whether standard relay 2 has been acknowledged.
Standard Relay 3 Flashing	N/A	12028	12028	N/A	4	N/A	False = 0, True = 1. Indicates whether standard relay 3 has been acknowledged.
Fault Relay Flashing	N/A	12029	12029	N/A	4	N/A	False = 0, True = 1. Indicates whether the fault has been acknowledged.
Horn Relay Flashing	N/A	12034	12034	N/A	4	N/A	False = 0, True = 1. Indicates whether the horn relay has been acknowledged.
<b>Channel Data</b>							
Alarm 1 Status	1-64	13449	13512	1	2	N/A	Off = 0, On = 1
Alarm 1 Flashing	1-64	13513	13576	1	2	N/A	Off = 0, On = 1
Alarm 2 Status	1-64	13577	13640	1	2	N/A	Off = 0, On = 1
Alarm 2 Flashing	1-64	13641	13704	1	2	N/A	Off = 0, On = 1
Alarm 3 Status	1-64	13705	13768	1	2	N/A	Off = 0, On = 1
Alarm 3 Flashing	1-64	13769	13832	1	2	N/A	Off = 0, On = 1

Fault Status	1-64	13833	13896	1	2	N/A	Off = 0, On = 1
Comm Error	1-64	13897	13960	1	2	N/A	Off = 0, On = 1
Config Error	1-64	13961	14024	1	2	N/A	Off = 0, On = 1
IO Error	1-64	14025	14088	1	2	N/A	Off = 0, On = 1
Cal Flag	1-64	14089	14152	1	2	N/A	Off = 0, On = 1
Marker Detected	1-64	14153	14216	1	2	N/A	Off = 0, On = 1
Linearizing	1-64	14217	14280	1	2	N/A	Set if the channel's linearize map is non default. Off = 0, On = 1
Error Flashing	1-64	14281	14344	1	2	N/A	Unacknowledged error. Off = 0, On = 1



### 5.3.3 INPUT REGISTERS

Type	Channel	First	Last	Block Size	Read FC	Write FC	Notes
Product ID	N/A	32001	32001	N/A	4	N/A	Reads value 72
Version	N/A	32002	32002	N/A	4	N/A	Reads version * 100
Custom Feature	N/A	32003	32003	N/A	4	N/A	N/A
Customer ID	N/A	32004	32004	N/A	4	N/A	N/A
Lock Status	N/A	32005	32005	N/A	4	N/A	Indicates the lock state for Modbus writes.  Locked = 1 Unlocked = 0
Boot Date, Year	N/A	32006	32006	N/A	4	N/A	System boot timestamp 0000 - 9999
Boot Date, Mon	N/A	32007	32007	N/A	4	N/A	System boot timestamp 0 – 12
Boot Date, Day	N/A	32008	32008	N/A	4	N/A	System boot timestamp 0 – 31
Boot Time, Hour	N/A	32009	32009	N/A	4	N/A	System boot timestamp 0 – 23
Boot Time, Min	N/A	32010	32010	N/A	4	N/A	System boot timestamp 0 – 59
Boot Time, Sec	N/A	32011	32011	N/A	4	N/A	System boot timestamp 0 – 59
Standard Relay 1 State	N/A	32020	32020	N/A	4	N/A	Off = 0, On = 1, doesn't take into account failsafe
Standard Relay 2 State	N/A	32021	32021	N/A	4	N/A	Off = 0, On = 1, doesn't take into account failsafe
Standard Relay 3 State	N/A	32022	32022	N/A	4	N/A	Off = 0, On = 1, doesn't take into account failsafe

Fault Relay State	N/A	32023	32023	N/A	4	N/A	Off = 0, On = 1, doesn't take into account failsafe
Horn Relay State	N/A	32024	32024	N/A	4	N/A	Off = 0, On = 1, doesn't take into account failsafe
Warmup	N/A	32025	32025	N/A	4	N/A	Not in warmup = 0 In warmup = 1
Standard Relay 1 Flashing	N/A	32026	32020	N/A	4	N/A	False = 0, True = 1. Indicates whether standard relay 1 has been acknowledged.
Standard Relay 2 Flashing	N/A	32027	32027	N/A	4	N/A	False = 0, True = 1. Indicates whether standard relay 2 has been acknowledged.
Standard Relay 3 Flashing	N/A	32028	32028	N/A	4	N/A	False = 0, True = 1. Indicates whether standard relay 3 has been acknowledged.
Fault Relay Flashing	N/A	32029	32029	N/A	4	N/A	False = 0, True = 1. Indicates whether the fault has been acknowledged.
Horn Relay Flashing	N/A	32034	32034	N/A	4	N/A	False = 0, True = 1. Indicates whether the horn relay has been acknowledged.
Active Port for COM1	N/A	32030	32030	N/A	4	N/A	When a redundant port is enabled, this value indicates which port is in use. (0) or the port number of the redundant port (1-3). (PortNumber – 1)
Active Port for COM2	N/A	32031	32031	N/A	4	N/A	See active port for COM1. (1) or the port number of the redundant port (0,2,3). (PortNumber – 1)

Active Port for COM3	N/A	32032	32032	N/A	4	N/A	See active port for COM1. (2) or the port number of the redundant port (0,1,3). (PortNumber – 1)
Active Port for COM4	N/A	32033	32033	N/A	4	N/A	See active port for COM1. (3) or the port number of the redundant port (0-2). (PortNumber – 1)
<b>Channel Data</b>							
Analog Output	1-64	31001	31064	1	4	N/A	16bit integer value tracking analog output. Uses a range of 800 – 4000 to represent 4-20mA.
Channel Value	1-64	33001	33064	1	4	N/A	16bit representation of float w/ +-5% over/under range. * see formula
Channel Value	1-64	33065	33192	2	4	N/A	32bit IEEE Floating point
Channel Value	1-64	33193	33384	3	4	N/A	Character string representation of value. 2 ASCII characters per register
Alarm 1 Status	1-64	33449	33512	1	4	N/A	Off = 0, On = 1
Alarm 1 Flashing	1-64	33513	33576	1	4	N/A	Off = 0, On = 1
Alarm 2 Status	1-64	33577	33640	1	4	N/A	Off = 0, On = 1
Alarm 2 Flashing	1-64	33641	33704	1	4	N/A	Off = 0, On = 1
Alarm 3 Status	1-64	33705	33768	1	4	N/A	Off = 0, On = 1
Alarm 3 Flashing	1-64	33769	33832	1	4	N/A	Off = 0, On = 1
Fault Status	1-64	33833	33896	1	4	N/A	Off = 0, On = 1

Comm Error	1-64	33897	33960	1	4	N/A	Off = 0, On = 1
Config Error	1-64	33961	34024	1	4	N/A	Off = 0, On = 1
IO Error	1-64	34025	34088	1	4	N/A	Off = 0, On = 1
Cal Flag	1-64	34089	34152	1	4	N/A	Off = 0, On = 1
Marker Detected	1-64	34153	34216	1	2	N/A	Off = 0, On = 1
Linearizing	1-64	34217	34280	1	2	N/A	Set if the channel's linearize map is non default. Off = 0, On = 1
Error Flashing	1-64	34281	34344	1	2	N/A	Unacknowledged error. Off = 0, On = 1
Sensor Life	1-64	34401	34464	1	4	N/A	-2 = Disabled, -1 = Cal Required, 0 – 100 = Sensor life

\* 16bit representation of float w/ +-5% over/under range is calculated as follows:

$$DisplayValue = ModbusValue * \frac{(SpanValue - ZeroValue) * 1.1}{32767} + ZeroValue - (SpanValue - ZeroValue) * .5$$

### 5.3.4 HOLDING REGISTERS

Type	Channel	First	Last	Block Size	Read FC	Write FC	Notes
Alarm Reset	N/A	40001	40001	N/A	3	6, 16	Simulates the alarm reset button. Write a value of 1 to activate.
System Name	N/A	40010	40017	N/A	3	6, 16	Character string, 2 characters per register
Date, Year	N/A	40020	40020	N/A	3	6, 16	0000 - 9999
Date, Mon	N/A	40021	40021	N/A	3	6, 16	0 – 12
Date, Day	N/A	40022	40022	N/A	3	6, 16	0 – 31
Time, Hour	N/A	40023	40023	N/A	3	6, 16	0 – 23
Time, Min	N/A	40024	40024	N/A	3	6, 16	0 – 59
Time, Sec	N/A	40025	40025	N/A	3	6, 16	0 – 59
Warmup Time	N/A	40027	40027	N/A	3	6, 16	Time in minutes. 0 – 5
Cal Purge Time	N/A	40028	40028	N/A	3	6, 16	Time in minutes. 0 – 5
Block Negative	N/A	40029	40029	N/A	3	6, 16	<b>No</b> = 0, <b>Yes</b> = 1
<b>Zone Names</b>							
Zone 1 Name	N/A	40030	40037	N/A	3	6, 16	Character string, 2 characters per register
Zone 2 Name	N/A	40038	40045	N/A	3	6, 16	Character string, 2 characters per register
Zone 3 Name	N/A	40046	40053	N/A	3	6, 16	Character string, 2 characters per register
Zone 4 Name	N/A	40054	40062	N/A	3	6, 16	Character string, 2 characters per register
Zone 5 Name	N/A	40062	40069	N/A	3	6, 16	Character string, 2 characters per register
Zone 6 Name	N/A	40070	40077	N/A	3	6, 16	Character string, 2 characters per register

Zone 7 Name	N/A	40078	40085	N/A	3	6, 16	Character string, 2 characters per register
Zone 8 Name	N/A	40086	40093	N/A	3	6, 16	Character string, 2 characters per register
<b>Actions</b>							
Save Config	N/A	40095	40095	N/A	3	6	Saves configuration now
Config Changed	N/A	40096	40096	N/A	3	6	This register is set to 1 when a configuration parameter has changed. The user can clear it by writing 0.
Security Unlock	N/A	40099	40099	N/A	3	6	This register must be written with the Modbus unlock code before any parameter can be written using function codes 6 or 16. 0000 – 9999, <b>1234</b>

### 5.3.5 STANDARD RELAY 1

Type	Channel	First	Last	Block Size	Read FC	Write FC	Notes
A1 Votes	N/A	40100	40100	N/A	3	6, 16	Alarm 1 channels required. 0 - 64
A2 Votes	N/A	40101	40101	N/A	3	6, 16	Alarm 2 channels required. 0 – 64
A3 Votes	N/A	40102	40102	N/A	3	6, 16	Alarm 3 channels required. 0 - 64
Acknowledge	N/A	40103	40103	N/A	3	6, 16	Relay is acknowledgeable. <b>No</b> = 0, <b>Yes</b> = 1
Failsafe	N/A	40104	40104	N/A	3	6, 16	Relay is failsafe. <b>No</b> = 0, <b>Yes</b> = 1
Zone 1 Enable	N/A	40105	40105	N/A	3	6, 16	Use zone 1 channels for voting. <b>No</b> = 0, <b>Yes</b> = 1
Zone 2 Enable	N/A	40106	40106	N/A	3	6, 16	Use zone 2 channels for voting. <b>No</b> = 0, <b>Yes</b> = 1

Zone 3 Enable	N/A	40107	40107	N/A	3	6, 16	Use zone 3 channels for voting. No = 0, Yes = 1
Zone 4 Enable	N/A	40108	40108	N/A	3	6, 16	Use zone 4 channels for voting. No = 0, Yes = 1
Zone 5 Enable	N/A	40109	40109	N/A	3	6, 16	Use zone 5 channels for voting. No = 0, Yes = 1
Zone 6 Enable	N/A	40110	40110	N/A	3	6, 16	Use zone 6 channels for voting. No = 0, Yes = 1
Zone 7 Enable	N/A	40111	40111	N/A	3	6, 16	Use zone 7 channels for voting. No = 0, Yes = 1
Zone 8 Enable	N/A	40112	40112	N/A	3	6, 16	Use zone 8 channels for voting. No = 0, Yes = 1
Override 1 Channel	N/A	40113	40113	N/A	3	6, 16	Create an override channel. <b>0</b> is disabled. 0 - 64
Override 1 Alarm	N/A	40114	40114	N/A	3	6, 16	Alarm for this override channel to use. <b>Alarm 1</b> = 0, Alarm 2 = 1, Alarm 3 = 2
Override 2 Channel	N/A	40115	40115	N/A	3	6, 16	Create an override channel. <b>0</b> is disabled. 0 - 64
Override 2 Alarm	N/A	40116	40116	N/A	3	6, 16	Alarm for this override channel to use. <b>Alarm 1</b> = 0, Alarm 2 = 1, Alarm 3 = 2
Override 3 Channel	N/A	40117	40117	N/A	3	6, 16	Create an override channel. <b>0</b> is disabled. 0 - 64

Override 3 Alarm	N/A	40118	40118	N/A	3	6, 16	Alarm for this override channel to use. <b>Alarm 1</b> = 0, Alarm 2 = 1, Alarm 3 = 2
Override 4 Channel	N/A	40119	40119	N/A	3	6, 16	Create an override channel. <b>0</b> is disabled. 0 - 64
Override 4 Alarm	N/A	40120	40120	N/A	3	6, 16	Alarm for this override channel to use. <b>Alarm 1</b> = 0, Alarm 2 = 1, Alarm 3 = 2
Override 5 Channel	N/A	40121	40121	N/A	3	6, 16	Create an override channel. <b>0</b> is disabled. 0 - 64
Override 5 Alarm	N/A	40122	40122	N/A	3	6, 16	Alarm for this override channel to use. <b>Alarm 1</b> = 0, Alarm 2 = 1, Alarm 3 = 2
Override 6 Channel	N/A	40123	40123	N/A	3	6, 16	Create an override channel. <b>0</b> is disabled. 0 - 64
Override 6 Alarm	N/A	40124	40124	N/A	3	6, 16	Alarm for this override channel to use. <b>Alarm 1</b> = 0, Alarm 2 = 1, Alarm 3 = 2
Override 7 Channel	N/A	40125	40125	N/A	3	6, 16	Create an override channel. <b>0</b> is disabled. 0 - 64



Override 7 Alarm	N/A	40126	40126	N/A	3	6, 16	Alarm for this override channel to use. <b>Alarm 1</b> = 0, Alarm 2 = 1, Alarm 3 = 2
Override 8 Channel	N/A	40127	40127	N/A	3	6, 16	Create an override channel. <b>0</b> is disabled. 0 - 64
Override 8 Alarm	N/A	40128	40128	N/A	3	6, 16	Alarm for this override channel to use. <b>Alarm 1</b> = 0, Alarm 2 = 1, Alarm 3 = 2

### 5.3.6 STANDARD RELAY 2

Type	Channel	First	Last	Block Size	Read FC	Write FC	Notes
A1 Votes	N/A	40140	40140	N/A	3	6, 16	Alarm 1 channels required. 0 - 64
A2 Votes	N/A	40141	40141	N/A	3	6, 16	Alarm 2 channels required. 0 - 64
A3 Votes	N/A	40142	40142	N/A	3	6, 16	Alarm 3 channels required. 0 - 64
Acknowledge	N/A	40143	40143	N/A	3	6, 16	Relay is acknowledgeable. <b>No</b> = 0, <b>Yes</b> = 1
Failsafe	N/A	40144	40144	N/A	3	6, 16	Relay is failsafe. <b>No</b> = 0, <b>Yes</b> = 1
Zone 1 Enable	N/A	40145	40145	N/A	3	6, 16	Use zone 1 channels for voting. <b>No</b> = 0, <b>Yes</b> = 1
Zone 2 Enable	N/A	40146	40146	N/A	3	6, 16	Use zone 2 channels for voting. <b>No</b> = 0, <b>Yes</b> = 1
Zone 3 Enable	N/A	40147	40147	N/A	3	6, 16	Use zone 3 channels for voting. <b>No</b> = 0, <b>Yes</b> = 1
Zone 4 Enable	N/A	40148	40148	N/A	3	6, 16	Use zone 4 channels for voting. <b>No</b> = 0, <b>Yes</b> = 1

Zone 5 Enable	N/A	40149	40149	N/A	3	6, 16	Use zone 5 channels for voting. No = 0, Yes = 1
Zone 6 Enable	N/A	40150	40150	N/A	3	6, 16	Use zone 6 channels for voting. No = 0, Yes = 1
Zone 7 Enable	N/A	40151	40151	N/A	3	6, 16	Use zone 7 channels for voting. No = 0, Yes = 1
Zone 8 Enable	N/A	40152	40152	N/A	3	6, 16	Use zone 8 channels for voting. No = 0, Yes = 1
Override 1 Channel	N/A	40153	40153	N/A	3	6, 16	Create an override channel. <b>0</b> is disabled. 0 - 64
Override 1 Alarm	N/A	40154	40154	N/A	3	6, 16	Alarm for this override channel to use. <b>Alarm 1</b> = 0, Alarm 2 = 1, Alarm 3 = 2
Override 2 Channel	N/A	40155	40155	N/A	3	6, 16	Create an override channel. <b>0</b> is disabled. 0 - 64
Override 2 Alarm	N/A	40156	40156	N/A	3	6, 16	Alarm for this override channel to use. <b>Alarm 1</b> = 0, Alarm 2 = 1, Alarm 3 = 2
Override 3 Channel	N/A	40157	40157	N/A	3	6, 16	Create an override channel. <b>0</b> is disabled. 0 - 64
Override 3 Alarm	N/A	40158	40158	N/A	3	6, 16	Alarm for this override channel to use. <b>Alarm 1</b> = 0, Alarm 2 = 1, Alarm 3 = 2
Override 4 Channel	N/A	40159	40159	N/A	3	6, 16	Create an override channel. <b>0</b> is disabled. 0 - 64

Override 4 Alarm	N/A	40160	40160	N/A	3	6, 16	Alarm for this override channel to use. <b>Alarm 1</b> = 0, Alarm 2 = 1, Alarm 3 = 2
Override 5 Channel	N/A	40161	40161	N/A	3	6, 16	Create an override channel. <b>0</b> is disabled. 0 - 64
Override 5 Alarm	N/A	40162	40162	N/A	3	6, 16	Alarm for this override channel to use. <b>Alarm 1</b> = 0, Alarm 2 = 1, Alarm 3 = 2
Override 6 Channel	N/A	40163	40163	N/A	3	6, 16	Create an override channel. <b>0</b> is disabled. 0 - 64
Override 6 Alarm	N/A	40164	40164	N/A	3	6, 16	Alarm for this override channel to use. <b>Alarm 1</b> = 0, Alarm 2 = 1, Alarm 3 = 2
Override 7 Channel	N/A	40165	40165	N/A	3	6, 16	Create an override channel. <b>0</b> is disabled. 0 - 64
Override 7 Alarm	N/A	40166	40166	N/A	3	6, 16	Alarm for this override channel to use. <b>Alarm 1</b> = 0, Alarm 2 = 1, Alarm 3 = 2
Override 8 Channel	N/A	40167	40167	N/A	3	6, 16	Create an override channel. <b>0</b> is disabled. 0 - 64

Override 8 Alarm	N/A	40168	40168	N/A	3	6, 16	Alarm for this override channel to use. <b>Alarm 1</b> = 0, Alarm 2 = 1, Alarm 3 = 2
------------------	-----	-------	-------	-----	---	-------	---

### 5.3.7 STANDARD RELAY 3

Type	Channel	First	Last	Block Size	Read FC	Write FC	Notes
A1 Votes	N/A	40180	40180	N/A	3	6, 16	Alarm 1 channels required. 0 - 64
A2 Votes	N/A	40181	40181	N/A	3	6, 16	Alarm 2 channels required. 0 - 64
A3 Votes	N/A	40182	40182	N/A	3	6, 16	Alarm 3 channels required. 0 - 64
Acknowledge	N/A	40183	40183	N/A	3	6, 16	Relay is acknowledgeable. <b>No</b> = 0, <b>Yes</b> = 1
Failsafe	N/A	40184	40184	N/A	3	6, 16	Relay is failsafe. <b>No</b> = 0, <b>Yes</b> = 1
Zone 1 Enable	N/A	40185	40185	N/A	3	6, 16	Use zone 1 channels for voting. <b>No</b> = 0, <b>Yes</b> = 1
Zone 2 Enable	N/A	40186	40186	N/A	3	6, 16	Use zone 2 channels for voting. <b>No</b> = 0, <b>Yes</b> = 1
Zone 3 Enable	N/A	40187	40187	N/A	3	6, 16	Use zone 3 channels for voting. <b>No</b> = 0, <b>Yes</b> = 1
Zone 4 Enable	N/A	40188	40188	N/A	3	6, 16	Use zone 4 channels for voting. <b>No</b> = 0, <b>Yes</b> = 1
Zone 5 Enable	N/A	40189	40189	N/A	3	6, 16	Use zone 5 channels for voting. <b>No</b> = 0, <b>Yes</b> = 1
Zone 6 Enable	N/A	40190	40190	N/A	3	6, 16	Use zone 6 channels for voting. <b>No</b> = 0, <b>Yes</b> = 1
Zone 7 Enable	N/A	40191	40191	N/A	3	6, 16	Use zone 7 channels for voting. <b>No</b> = 0, <b>Yes</b> = 1
Zone 8 Enable	N/A	40192	40192	N/A	3	6, 16	Use zone 8 channels for voting. <b>No</b> = 0, <b>Yes</b> = 1

Override 1 Channel	N/A	40193	40193	N/A	3	6, 16	Create an override channel. <b>0</b> is disabled. 0 - 64
Override 1 Alarm	N/A	40194	40194	N/A	3	6, 16	Alarm for this override channel to use. <b>Alarm 1</b> = 0, Alarm 2 = 1, Alarm 3 = 2
Override 2 Channel	N/A	40195	40195	N/A	3	6, 16	Create an override channel. <b>0</b> is disabled. 0 - 64
Override 2 Alarm	N/A	40196	40196	N/A	3	6, 16	Alarm for this override channel to use. <b>Alarm 1</b> = 0, Alarm 2 = 1, Alarm 3 = 2
Override 3 Channel	N/A	40197	40197	N/A	3	6, 16	Create an override channel. <b>0</b> is disabled. 0 - 64
Override 3 Alarm	N/A	40198	40198	N/A	3	6, 16	Alarm for this override channel to use. <b>Alarm 1</b> = 0, Alarm 2 = 1, Alarm 3 = 2
Override 4 Channel	N/A	40199	40199	N/A	3	6, 16	Create an override channel. <b>0</b> is disabled. 0 - 64
Override 4 Alarm	N/A	40200	40200	N/A	3	6, 16	Alarm for this override channel to use. <b>Alarm 1</b> = 0, Alarm 2 = 1, Alarm 3 = 2
Override 5 Channel	N/A	40201	40201	N/A	3	6, 16	Create an override channel. <b>0</b> is disabled. 0 - 64

Override 5 Alarm	N/A	40202	40202	N/A	3	6, 16	Alarm for this override channel to use. <b>Alarm 1</b> = 0, Alarm 2 = 1, Alarm 3 = 2
Override 6 Channel	N/A	40203	40203	N/A	3	6, 16	Create an override channel. <b>0</b> is disabled. 0 - 64
Override 6 Alarm	N/A	40204	40204	N/A	3	6, 16	Alarm for this override channel to use. <b>Alarm 1</b> = 0, Alarm 2 = 1, Alarm 3 = 2
Override 7 Channel	N/A	40205	40205	N/A	3	6, 16	Create an override channel. <b>0</b> is disabled. 0 - 64
Override 7 Alarm	N/A	40206	40206	N/A	3	6, 16	Alarm for this override channel to use. <b>Alarm 1</b> = 0, Alarm 2 = 1, Alarm 3 = 2
Override 8 Channel	N/A	40207	40207	N/A	3	6, 16	Create an override channel. <b>0</b> is disabled. 0 - 64
Override 8 Alarm	N/A	40208	40208	N/A	3	6, 16	Alarm for this override channel to use. <b>Alarm 1</b> = 0, Alarm 2 = 1, Alarm 3 = 2

### 5.3.8 DISCRETE RELAYS

Type	Channel	First	Last	Block Size	Read FC	Write FC	Notes
------	---------	-------	------	------------	---------	----------	-------

A1 Failsafe	N/A	40220	40220	N/A	3	6, 16	Makes discrete relays boards that use alarm 1 failsafe. <b>No</b> = 0, <b>Yes</b> = 1
A2 Failsafe	N/A	40221	40221	N/A	3	6, 16	Makes discrete relays boards that use alarm 2 failsafe. <b>No</b> = 0, <b>Yes</b> = 1
A3 Failsafe	N/A	40222	40222	N/A	3	6, 16	Makes discrete relays boards that use alarm 3 failsafe. <b>No</b> = 0, <b>Yes</b> = 1

### 5.3.9 HORN/PIEZO

Type	Channel	First	Last	Block Size	Read FC	Write FC	Notes
Alarm 1 Mode	N/A	40230	40230	N/A	3	6, 16	Off = 0, On = 1, <b>Beep</b> = 2
Alarm 2 Mode	N/A	40231	40231	N/A	3	6, 16	Off = 0, <b>On</b> = 1, Beep = 2
Alarm 3 Mode	N/A	40232	40232	N/A	3	6, 16	Off = 0, <b>On</b> = 1, Beep = 2
Acknowledge	N/A	40233	40233	N/A	3	6, 16	Off = 0, <b>On</b> = 1
Failsafe	N/A	40234	40234	N/A	3	6, 16	<b>No</b> = 0, <b>Yes</b> = 1
Piezo Alarm	N/A	40235	40235	N/A	3	6, 16	<b>No</b> = 0, <b>Yes</b> = 1

### 5.3.10 CHANNEL CONFIGURATION

Type	Channel	First	Last	Block Size	Read FC	Write FC	Notes
Tag	1-64	40401	40912	8	3	16	2 characters per register
Eng. Units	1-64	40913	41104	3	3	16	2 characters per register
Zero Value	1-64	41297	41424	2	3	16	Integer and divisor
Zero Value	1-64	41425	41552	2	3	16	32bit IEEE Float
Span Value	1-64	41553	41680	2	3	16	Integer and divisor
Span Value	1-64	41681	41808	2	3	16	32bit IEEE Float
<b>Alarm 1</b>							
Setpoint	1-64	41809	41936	2	3	16	Integer and divisor
Setpoint	1-64	41937	42064	2	3	16	32bit IEEE Float
Latching	1-64	42065	42128	1	3	6, 16	<b>No</b> = 0, <b>Yes</b> = 1
Trip	1-64	42129	42192	1	3	6, 16	Low = 0, <b>high</b> = 1
On Delay	1-64	42193	42256	1	3	6, 16	Time in seconds. 0 – 10
Off Delay	1-64	42257	42320	1	3	6, 16	Time in minutes. 0 - 120
Horn Drive	1-64	42321	42448	1	3	6, 16	No = 0, <b>Yes</b> = 1
<b>Alarm 2</b>							
Setpoint	1-64	42449	42576	2	3	16	Integer and divisor
Setpoint	1-64	42577	42704	2	3	16	32bit IEEE Float
Latching	1-64	42705	42768	1	3	6, 16	<b>No</b> = 0, <b>Yes</b> = 1
Trip	1-64	42769	42832	1	3	6, 16	Low = 0, <b>high</b> = 1
On Delay	1-64	42833	42896	1	3	6, 16	Time in seconds. 0 – 10
Off Delay	1-64	42897	42960	1	3	6, 16	Time in minutes. 0 - 120
Horn Drive	1-64	42961	43024	1	3	6, 16	No = 0, <b>Yes</b> = 1



Color	1-64	43025	43088	1	3	6, 16	Alarm color displayed on the unit <b>Red</b> = 0, Blue = 1, Orange = 2
<b>Alarm 3</b>							
Setpoint	1-64	43089	43216	2	3	16	Integer and divisor
Setpoint	1-64	43217	43344	2	3	16	32bit IEEE Float
Latching	1-64	43345	43408	1	3	6, 16	<b>No</b> = 0, <b>Yes</b> = 1
Trip	1-64	43409	43472	1	3	6, 16	Low = 0, <b>high</b> = 1
On Delay	1-64	43473	43536	1	3	6, 16	Time in seconds. 0 – 10
Off Delay	1-64	43537	43600	1	3	6, 16	Time in minutes. 0 - 120
Horn Drive	1-64	43601	43664	1	3	6, 16	No = 0, <b>Yes</b> = 1
Color	1-64	43665	43728	1	3	6, 16	Alarm color displayed on the unit <b>Red</b> = 0, Blue = 1, Orange = 2
Enable	1-64	43729	43792	1	3	6, 16	<b>No</b> = 0, <b>Yes</b> = 1
<b>Fault</b>							
Setpoint	1-64	43793	43920	2	3	16	Integer and divisor
Setpoint	1-64	43921	44048	2	3	16	32bit IEEE Float
<b>Data From</b>							
Source	1-64	44369	44432	1	3	6, 16	<b>Analog In</b> = 0, Modbus 16bit = 1, Signed Modbus 16bit = 2, Modbus 32bit = 3, Wireless Monitor = 4, Digital In = 5

Min Raw	1-64	44433	44496	1	3	6, 16	Integer
Max Raw	1-64	44497	44560	1	3	6, 16	Integer
Remote ID	1-64	44561	44624	1	3	6, 16	0 – 247
Interface	1-64	44625	44688	1	3	6, 16	<b>COM1</b> = 0 COM2 = 1 COM3 = 2 COM4 = 3 TCP/IP = 4
Filter Count	1-64	44689	44752	1	3	6,16	1 – 40
Local Cal	1-64	44753	44816	1	3	6,16	No = 0, Yes = 1, <b>Board Default</b> = 2
Byte Order	1-64	44881	44944	1	3	6,16	ABCD = 0 CDAB = 1 <b>BADC</b> = 2 DCBA = 3
Alias	1-64	44945	45072	2	3	16	Modbus alias. 0 – 65535
IP Address	1-64	45073	45200	2	3	16	Target address for ModbusTCP
TCP/IP Port	1-64	45201	45328	1	3	6, 16	TCP/IP port for ModbusTCP. 0 - 65535
<b>Linearize Map</b>							
Point 1	1-64	45329	45584	4	3	16	2x 32bit IEEE Floats, Input and Output
Point 2	1-64	45585	45840	4	3	16	2x 32bit IEEE Floats, Input and Output
Point 3	1-64	45841	46096	4	3	16	2x 32bit IEEE Floats, Input and Output
Point 4	1-64	46097	46352	4	3	16	2x 32bit IEEE Floats, Input and Output
Point 5	1-64	46353	46608	4	3	16	2x 32bit IEEE Floats, Input and Output

Point 6	1-64	46609	46864	4	3	16	2x 32bit IEEE Floats, Input and Output
Point 7	1-64	46865	47120	4	3	16	2x 32bit IEEE Floats, Input and Output
Point 8	1-64	47121	47376	4	3	16	2x 32bit IEEE Floats, Input and Output
Point 9	1-64	47377	47632	4	3	16	2x 32bit IEEE Floats, Input and Output
<b>Configure</b>							
Decimal Points	1-64	47633	47696	1	3	6, 16	<b>0</b> = 0, 1 = 1, 2 = 2, 3 = 3,
Channel Enable	1-64	47697	47760	1	3	6, 16	No = 0, <b>Yes</b> = 1
Zone	1-64	47761	47824	1	3	6, 16	<b>Zone 1</b> = 0, Zone 2 = 1, Zone 3 = 2, Zone 4 = 3, Zone 5 = 4, Zone 6 = 5, Zone 7 = 6, Zone 8 = 7,
Deadband%	1-64	47825	47952	2	3	16	32bit IEEE Float (0.0 – 5.0)

### 5.3.11 PROGRAMMABLE RELAYS

The programmable relay option allows 16 relays to be configured. The configuration parameters are the same for all 16 relays. The following table shows the base address of each programmable relay.

Programmable Relay Number	Base Modbus Address
Relay 1	49000

Relay 2	49040
Relay 3	49080
Relay 4	49120
Relay 5	49160
Relay 6	49200
Relay 7	49240
Relay 8	49280
Relay 9	49320
Relay 10	49360
Relay 11	49400
Relay 12	49440
Relay 13	49480
Relay 14	49520
Relay 15	49560
Relay 16	49600

The register for each relay parameter is determined by adding the offset to that relay's base address.

Type	Channel	Address Offset	Block Size	Read FC	Write FC	Notes
A1 Votes	N/A	0	N/A	3	6, 16	Alarm 1 channels required. 0 - 64
A2 Votes	N/A	1	N/A	3	6, 16	Alarm 2 channels required. 0 - 64
A3 Votes	N/A	2	N/A	3	6, 16	Alarm 3 channels required. 0 - 64
Acknowledge	N/A	3	N/A	3	6, 16	Relay is acknowledgeable. <b>No</b> = 0, <b>Yes</b> = 1
Failsafe	N/A	4	N/A	3	6, 16	Relay is failsafe. <b>No</b> = 0, <b>Yes</b> = 1
Zone 1 Enable	N/A	5	N/A	3	6, 16	Use zone 1 channels for voting. <b>No</b> = 0, <b>Yes</b> = 1
Zone 2 Enable	N/A	6	N/A	3	6, 16	Use zone 2 channels for voting. <b>No</b> = 0, <b>Yes</b> = 1

Zone 3 Enable	N/A	7	N/A	3	6, 16	Use zone 3 channels for voting. No = 0, <b>Yes</b> = 1
Zone 4 Enable	N/A	8	N/A	3	6, 16	Use zone 4 channels for voting. No = 0, <b>Yes</b> = 1
Zone 5 Enable	N/A	9	N/A	3	6, 16	Use zone 5 channels for voting. No = 0, <b>Yes</b> = 1
Zone 6 Enable	N/A	10	N/A	3	6, 16	Use zone 6 channels for voting. No = 0, <b>Yes</b> = 1
Zone 7 Enable	N/A	11	N/A	3	6, 16	Use zone 7 channels for voting. No = 0, <b>Yes</b> = 1
Zone 8 Enable	N/A	12	N/A	3	6, 16	Use zone 8 channels for voting. No = 0, <b>Yes</b> = 1
Override 1 Channel	N/A	13	N/A	3	6, 16	Create an override channel. <b>0</b> is disabled. 0 - 64
Override 1 Alarm	N/A	14	N/A	3	6, 16	Alarm for this override channel to use. <b>Alarm 1</b> = 0, Alarm 2 = 1, Alarm 3 = 2
Override 2 Channel	N/A	15	N/A	3	6, 16	Create an override channel. <b>0</b> is disabled. 0 - 64
Override 2 Alarm	N/A	16	N/A	3	6, 16	Alarm for this override channel to use. <b>Alarm 1</b> = 0, Alarm 2 = 1, Alarm 3 = 2
Override 3 Channel	N/A	17	N/A	3	6, 16	Create an override channel. <b>0</b> is disabled. 0 - 64
Override 3 Alarm	N/A	18	N/A	3	6, 16	Alarm for this override channel to use. <b>Alarm 1</b> = 0, Alarm 2 = 1, Alarm 3 = 2
Override 4 Channel	N/A	19	N/A	3	6, 16	Create an override channel. <b>0</b> is disabled. 0 - 64

Override 4 Alarm	N/A	20	N/A	3	6, 16	Alarm for this override channel to use.  <b>Alarm 1</b> = 0, Alarm 2 = 1, Alarm 3 = 2
Override 5 Channel	N/A	21	N/A	3	6, 16	Create an override channel. <b>0</b> is disabled. 0 - 64
Override 5 Alarm	N/A	22	N/A	3	6, 16	Alarm for this override channel to use.  <b>Alarm 1</b> = 0, Alarm 2 = 1, Alarm 3 = 2
Override 6 Channel	N/A	23	N/A	3	6, 16	Create an override channel. <b>0</b> is disabled. 0 - 64
Override 6 Alarm	N/A	24	N/A	3	6, 16	Alarm for this override channel to use.  <b>Alarm 1</b> = 0, Alarm 2 = 1, Alarm 3 = 2
Override 7 Channel	N/A	25	N/A	3	6, 16	Create an override channel. <b>0</b> is disabled. 0 - 64
Override 7 Alarm	N/A	26	N/A	3	6, 16	Alarm for this override channel to use.  <b>Alarm 1</b> = 0, Alarm 2 = 1, Alarm 3 = 2
Override 8 Channel	N/A	27	N/A	3	6, 16	Create an override channel. <b>0</b> is disabled. 0 - 64
Override 8 Alarm	N/A	28	N/A	3	6, 16	Alarm for this override channel to use.  <b>Alarm 1</b> = 0, Alarm 2 = 1, Alarm 3 = 2



## SECTION 6 ENCLOSURE OPTIONS

### 6.1 ViewSmart 6400PM PANEL / RACK MOUNT ENCLOSURE

The ViewSmart 6400PM shown in

Figure 6-1 is a half width 19" rack enclosure. It is supplied with hardware that allows mounting in either a 1/2 width 19" rack style cabinet or it may be panel mounted in a rectangular cutout (7.1" x 9.3"). Only one 16 channel I/O option Boards such as analog input or discrete relays may be mounted directly to the back of the enclosure.

Additional 16 channel I/O option boards must be located external from the assembly on another mounting plate. An extension I<sup>2</sup>C cable up to 10' is required for this purpose. Weight is approximately 7 pounds. Properly ground the enclosure and follow national and local electrical codes.

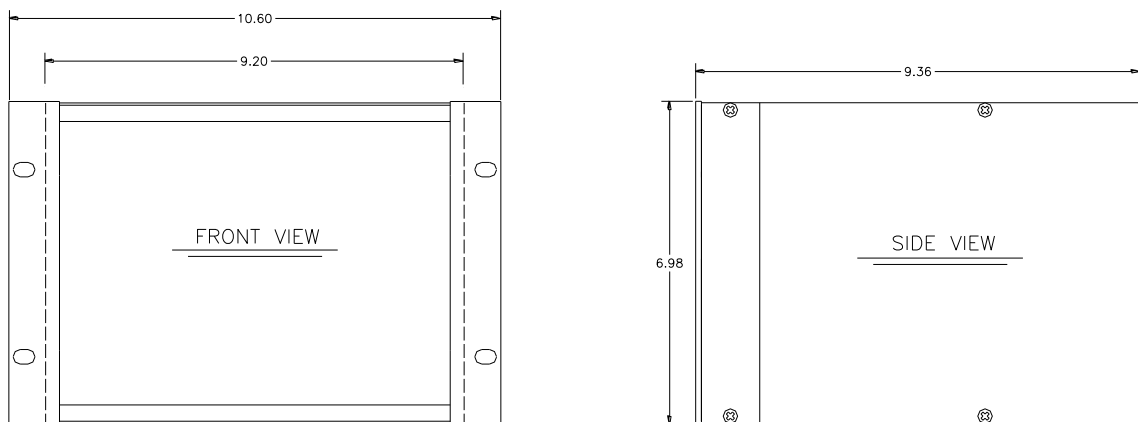

Figure 6-1

Rack/Panel Mount

(Panel Mount Bezel Not Shown)



## 6.2 ViewSmart 6400N4 NEMA 4X LARGE WALL MOUNT FIBERGLASS ENCLOSURE

The ViewSmart 6400N4 shown in

Figure 6-2 is a fiberglass NEMA 4X wall mount enclosure. Eleven, 16 channel I/O option boards, such as analog input or discrete relays, may be mounted inside this enclosure with the addition of a 0010-1269 expansion plate. It is suitable for mounting outdoors but an above mounted weather deflector shield is recommended. Weight is approximately 55 pounds. Figure 6-4 provides important warning information concerning correct grounding procedures for non-metallic enclosures. Conduit entries are not provided so installers may place entries as needed. Bottom or lower side areas are recommended. Care must be taken to avoid drilling into circuit boards mounted inside the enclosure. Properly ground the enclosure and follow national and local electrical codes.

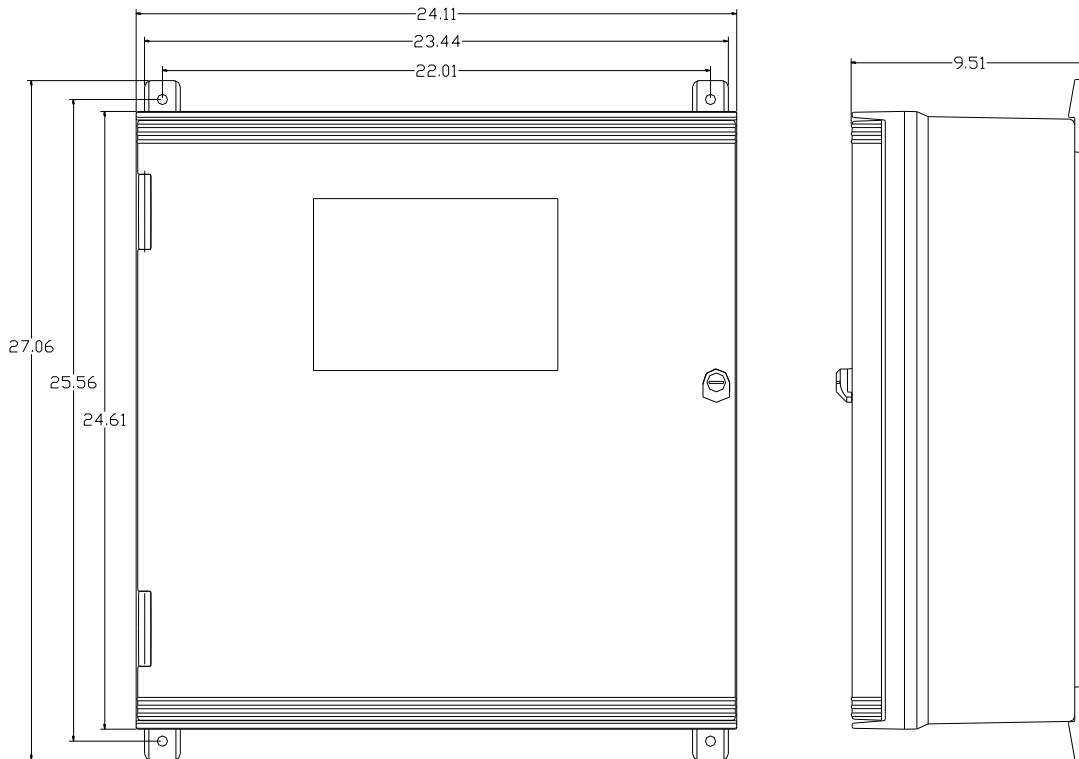

Figure 6-2

NEMA 4X Wall Mount

### **6.3 ViewSmart 6400CP NEMA 4X COMPACT WALL MOUNT FIBERGLASS ENCLOSURE**

The ViewSmart 6400CP shown in Figure 6-3 is a fiberglass NEMA 4X wall mount enclosure. One, 16 channel I/O option PCB's, such as analog input or relays, may be mounted inside this enclosure making it ideal for Modbus or wireless applications. It is suitable for mounting outdoors but an above mounted weather deflector shield is recommended. Weight is approximately 17 pounds. Figure 6-4 provides important warning information concerning correct grounding procedures for non-metallic enclosures. Conduit entries are not provided so installers may place entries as needed. Bottom or lower side areas are recommended. Care must be taken to avoid drilling into

circuit boards mounted inside the enclosure. Properly ground the enclosure and follow national and local electrical codes.

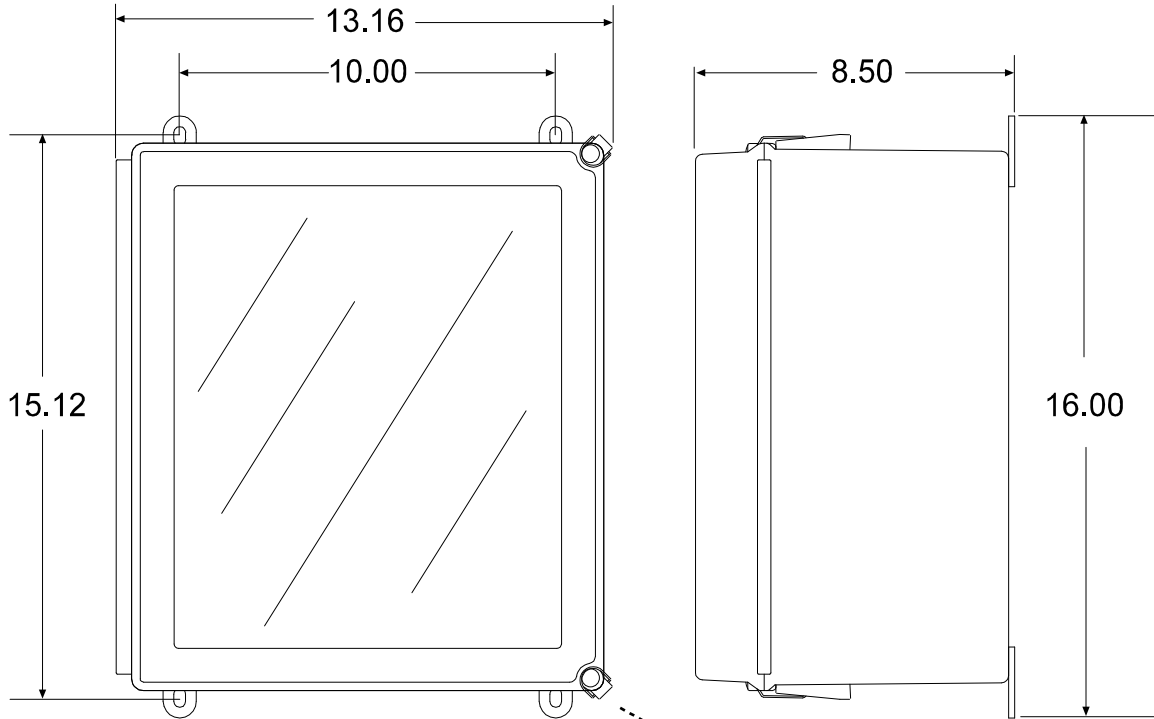

Note: 4 mounting holes are .31 diameter

**SHOCK HAZARD**

ADD LOCKING DEVICE TO CLASP ON BOTTOM RIGHT SIDE TO PREVENT CONTACT WITH DANGEROUS VOLTAGES. REMOVE AC POWER BEFORE SERVICING EQUIPMENT.

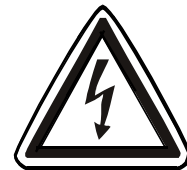

**NEMA 4X WALL MOUNT**

Figure 6-3



**GROUNDING OF EQUIPMENT AND CONDUIT**

Ground in accordance with the requirements of the National Electrical Code.  
 Conduit hubs for metallic conduit must have a grounding bushing attached to the hub on the inside of the enclosure. Grounding bushings have provisions for connection of a grounding wire. Non-metallic conduit and hubs require the use of a grounding wire in the conduit. Grounding bushings are not required. System grounding is provided by connection wires from all conduit entries to the subpanel or to other suitable point which provides continuity. Any device having a metal portion or portions extending out of the enclosure must also be properly grounded.

**TYPICAL GROUNDING ILLUSTRATIONS**  
**METALLIC CONDUIT                      NON-METALLIC CONDUIT**

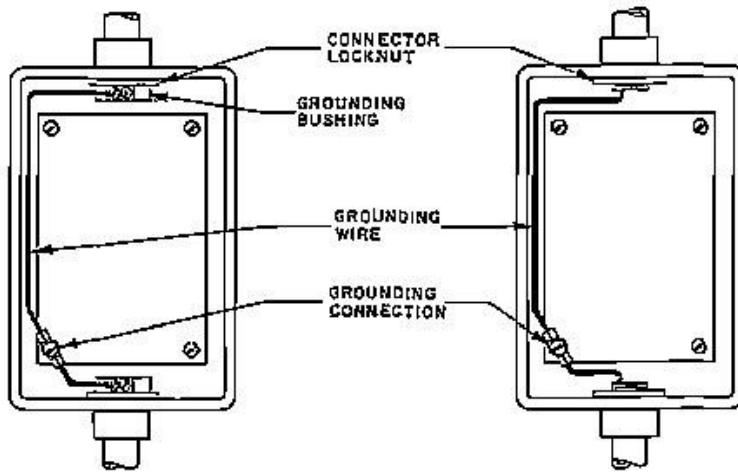

Figure 6-4

## 6.4 ViewSmart 6400XP NEMA 7 WALL MOUNT ALUMINUM ENCLOSURE

The ViewSmart 6400XP shown in

Figure 6-5 is an aluminum NEMA 4X / 7 wall mount enclosure designed for mounting into DIV 1&2 Groups B,C,D potentially hazardous areas. Five, 16 channel I/O option PCB's, such as analog inputs or discrete relays, may be mounted inside this enclosure with the addition of a 0010-1284 expansion plate. It is suitable for mounting outdoors but an above mounted weather deflector shield is recommended. Weight is approximately 110 pounds. Properly ground the enclosure and follow national and local electrical codes.

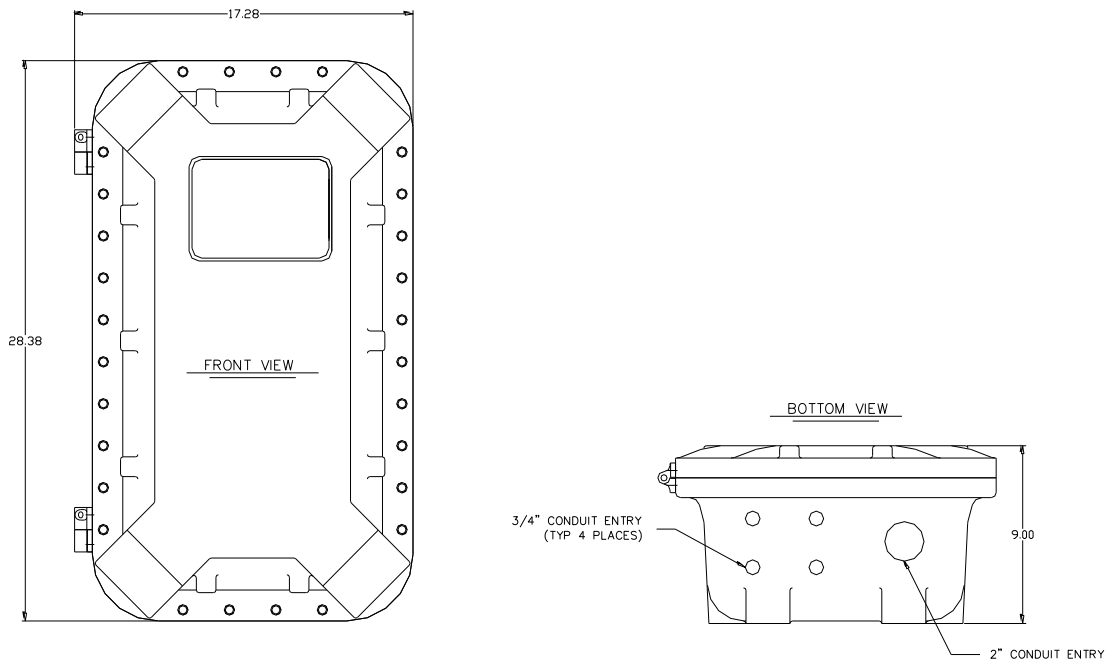

Figure 6-5  
NEMA 7 Wall Mount

## **6.5 ViewSmart 6400 MAIN I/O & OPTION PCB FOOTPRINT DIMENSIONS AND ENCLOSURE CAPACITIES**

ViewSmart 6400 controllers have virtually unlimited possibilities for configuration of options such as analog I/O, relays, and others. Figure 6-6 provides the Main I/O and all option PCB dimensions and mounting footprint. All ViewSmart 6400 enclosure styles require the Main I/O PCB (Figure 3-1) but also support the mounting of additional option PCB's as described below:

- 72-01 Panel mount
  - One option + I/O
  - Use aluminum 19" expansion plate adds Four options (RCS Part #0010-0321)
- 72-02 Full 19" Rack mount (one ViewSmart 6400)
  - Three options + I/O
  - Use aluminum 19" expansion plate adds Four options (RCS Part #0010-0321)
- 72-03 Full 19" Rack mount (two ViewSmart 6400s)
  - Two options + 2 I/O
  - Use aluminum 19" expansion plate adds Four options (RCS Part #0010-0321)
- 72-04 NEMA 4X Large fiberglass enclosure
  - Six options + I/O
  - Or two single/dual radio options + five regular options + I/O
  - Use NEMA 4X expansion plate adds Five options (RCS Part #0010-1269)
- 72-05 NEMA 4X Stainless steel enclosure
  - Six options + I/O
  - Or two single/dual radio options + five regular options + I/O
  - Use NEMA 4X expansion plate adds Five options (RCS Part #0010-1269)
- 72-06 NEMA 7 Div. 1 enclosure
  - Three options + I/O
  - Use NEMA 7 expansion plate adds Two options (RCS Part #0010-1284)
- 72-07 NEMA 4X compact fiberglass enclosure
  - One single/dual radio option + I/O
  - Use NEMA 4X compact expansion plate adds One option (RCS Part #0010-1323)

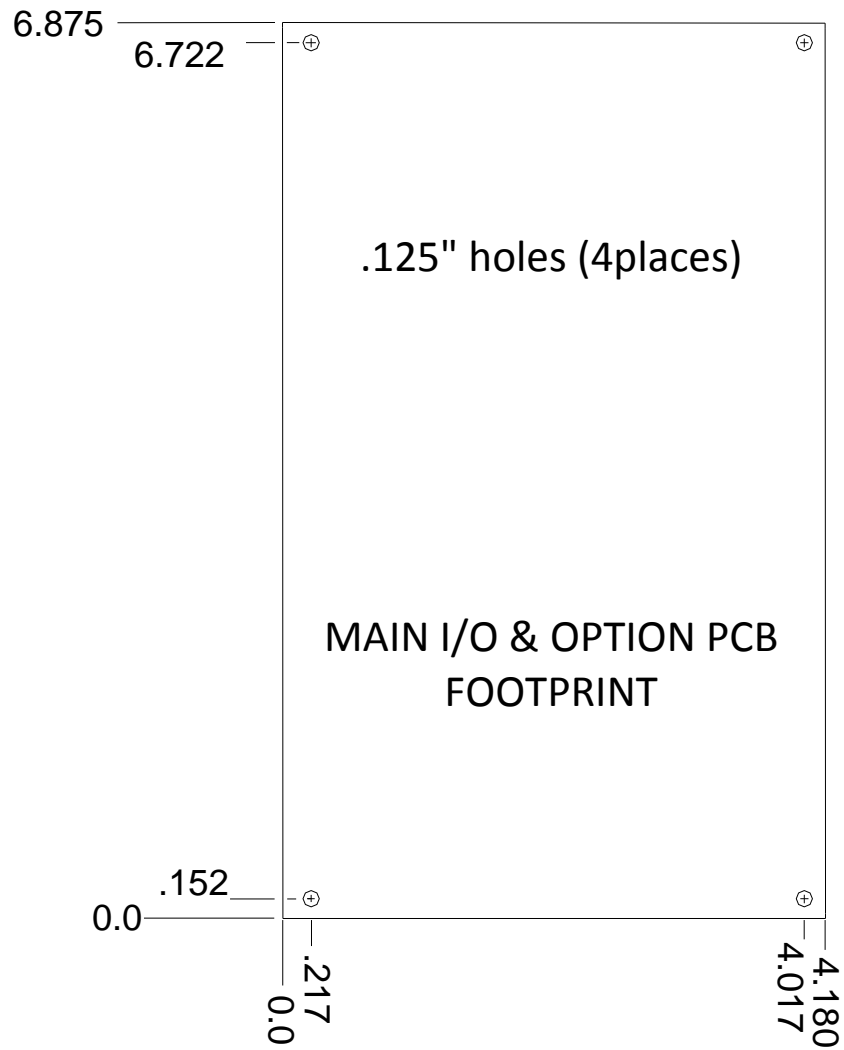

Figure 6-6

Option Board Dimensions and Mounting Footprint

## SECTION 7 WIRELESS OPTION

ViewSmart 6400's communication ports may be connected to a FHSS (Frequency Hopping Spread Spectrum) wireless radio modem shown in

Figure7-1. There are two different frequency options offered, 900 MHz and 2.4 GHz. 900 MHz is available in a single port modem (10-0364) or dual port modem (10-0365). 2.4 GHz is also available in a single port (10-0357) or dual port modem (10-0358). The dual port radio modems have two radio modules installed and can be used to receive and transmit data simultaneously. The radio kit options allow three separate modes of wireless operation. These are "Wireless Monitor" ([section 7.2](#)) accepting data from [ST-48/RF](#) sensor transmitters, "Wireless Modbus Slave" ([section 7.3](#)) providing data to a Modbus *master* (*master* side of network requires additional radio), and "Wireless Modbus Master" ([section 7.4](#)) accepting wireless data from Modbus *slaves* (*slaves* side of network requires additional radio). When used in the "Wireless Receiver" mode the radio must be connected to a port configured for **WIRELESS MONITOR**. "Wireless Modbus Master" mode requires the radio be connected to the ViewSmart 6400's RS-485 port configured for **MODBUS MASTER** and "Wireless Modbus Slave" mode connects it to the RS-485 port configured for **MODBUS SLAVE** ([Section 2.5.1.1](#)). It is important to remember RADIO SETUP functions described in [section 7.1](#) may be performed from the **COMMUNICATION SETTINGS** menu.

Each transceiver on a wireless network must have their **RADIO SETUP** menus configured to share the same hopping channel (0-32) and System ID (0-255) to communicate. All R.C. Systems wireless transceivers utilize a Server-Client network where Clients synchronize their hopping to the Server. The Server transmits a beacon at the beginning of every hop (50 times per second). Client transceivers listen for this beacon and upon hearing it will indicate **InRange** with the LED on the radio modem board and synchronize their hopping with the Server. Each network should consist of only one Server. There should never be two servers on the same RF Channel number in the same coverage area as the interference between the two servers will severely hinder RF communications. The Server must be in a powered location (as opposed to a battery powered ST-48/RF utilizing a "sleep" mode) and Servers typically should be centrally located since all Clients must receive the beacon in order to communicate.



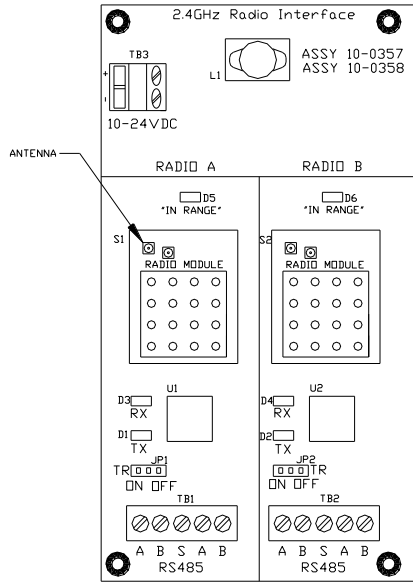

2.4 GHz Radio Modem

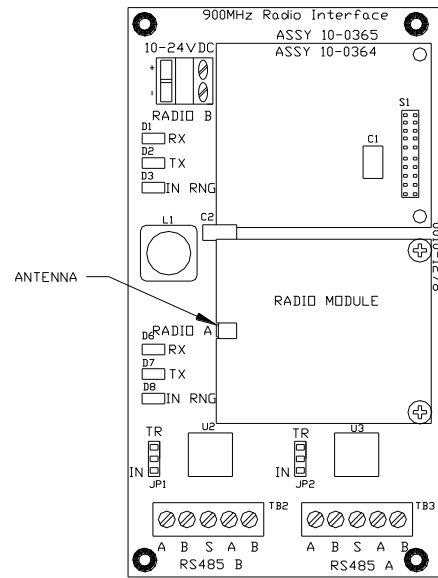

900 MHz Radio Modem

**Note:**

- 10-0357 Has One Radio Module Installed
- 10-0358 Has Two Radio Modules Installed

**Note:**

- 10-0364 Has One Radio Module Installed
- 10-0365 Has Two Radio Modules Installed

Figure7-1

## 7.1 RADIO SETUP MENU

Radio modules connected to the ViewSmart 6400's communication port may be

configured through the **RADIO SETUP** menu. Pressing the  key with the arrow pointing to the **Radio Setup** menu brings the **RADIO SETUP** menus to the screen (right side of Figure 7-2).

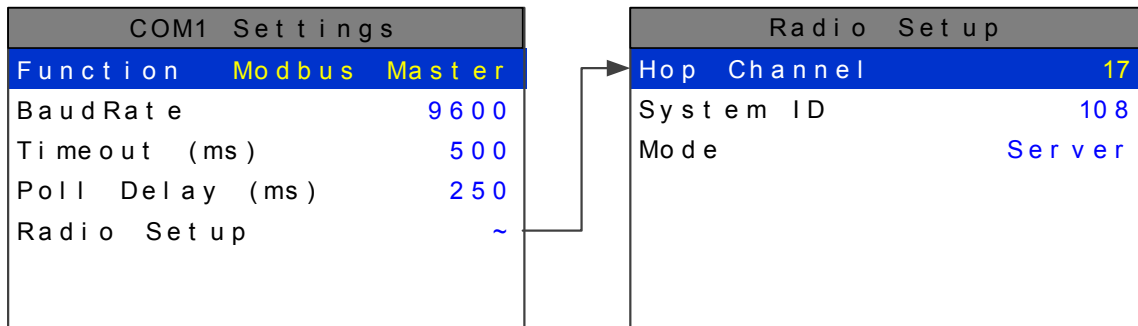

COM1-4 Menus are Identical

Figure 7-2

### 7.1.1 HOP CHANNEL

**Hop Channel** may be set from 1-32 using the ViewSmart 6400 keypad and assigns the pseudo-random radio frequency hopping pattern. A transceiver will not go **InRange** of or communicate with a transceiver operating on a different **Hop Channel**.

### 7.1.2 SYSTEM ID

**System ID** may be set from 1-255 using the ViewSmart 6400 keypad and is similar to a password character or network number and makes network eavesdropping more difficult. A transceiver will not go in range of or communicate with a transceiver operating on a different **System ID**.

### 7.1.3 MODE

**Mode** may be set for **CLIENT** or **SERVER**. For a single ViewSmart 6400 communicating to up to 64 battery powered ST-48/RF transceivers, **Mode** must = **Server**. To prolong battery life, ST-48/RFs sleep most of the time and therefore may not be **Servers**. If an application calls for multiple ViewSmart 6400 locations, only one may be set for **Server** and all others must be **Clients**. This single **Server** transmits a beacon which all of the network's **Clients** synchronize to. **ONLY ONE SERVER PER NETWORK**.

## 7.2 WIRELESS MONITOR MODE

**Wireless Monitor** mode is exclusively for wireless communication to our ST-48/RF wireless sensor transmitters (please visit [ST-48/RF](#)). In **Monitor** mode the radio connects to the ViewSmart 6400's communication port and receives input data from up to 64 ST-48/RF sensor transmitters. Wired and wireless inputs may be mixed between the ViewSmart 6400's 64 channels so it is possible to also accept wired signals from analog input option PCBs described in [section 3.2](#).

Use the **WIRELESS MONITOR** setting shown in Figure 7-3 ONLY FOR COMMUNICATION TO ST-48/RF WIRELESS TRANSCEIVERS. [See section 7.4](#) for setting up wireless networks with other Modbus slave devices.

ST-48/RFs transmit 200 counts for 0% and 1000 counts for 100% full scale readings so **Input Min/Max** menu values should be 200 & 1000. The **Remote ID** menu entry must match the **Remote Id** address setting in the ST-48/RF providing data to this ViewSmart 6400 channel. **Input Req** is typically set to **VALUE** but also allows a **Battery Voltage** entry into this field. Entering **Battery Voltage** causes the channel to display (and alarm) from battery voltage levels at this ST-48/RF. Voltage level of the 3.6 volt lithium battery in this ST-48/RF is also displayed on this screen.

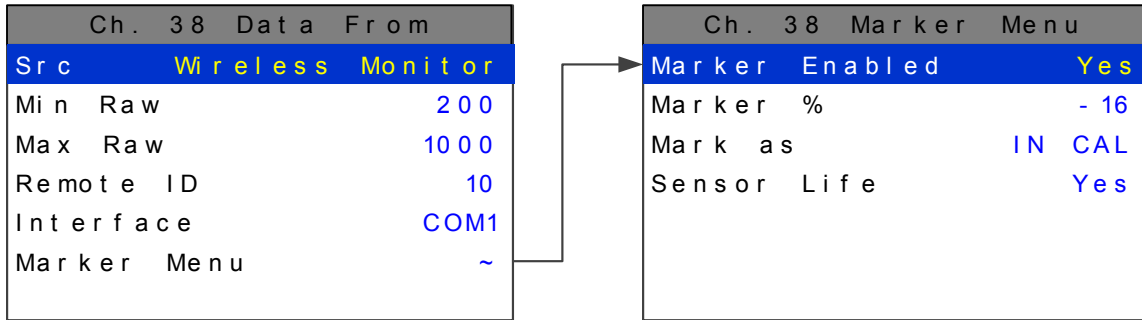

Figure 7-3

### 7.2.1 RADIO STATUS ALARMS - WIRELESS MONITOR MODE

When an ViewSmart 6400 channel's **INPUT DATA FROM** menu is set for **WIRELESS MONITOR**, in addition to processing the ST-48/RF's 10-bit "counts" value, it also receives status bits indicating **Communications Error, Low Battery** and **Calibration**.

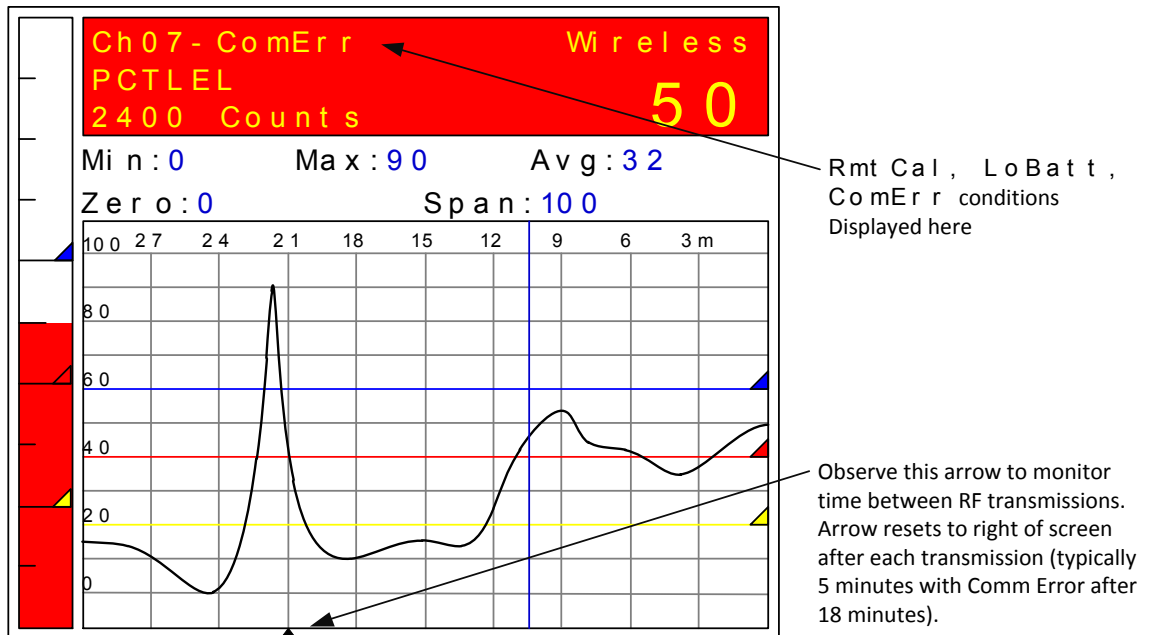

Figure 7-4

#### 7.2.1.1 COMMUNICATIONS ERROR

Each channel's 30-minute trend screen (Figure 7-4) is very useful for diagnosing wireless problems since it indicates amount of time since the most recent transmission was

received. The arrow on the bottom of the trend screen resets to far right each time a transmission is received by that channel. When not in alarm, ST-48/RFs transmit every 5-minutes so the arrow should never progress past the 5-minute interval. The ViewSmart 6400 activates the channel's FAULT alarm and indicates ComErr if no transmission has been received in 18 consecutive minutes. This interval can be adjusted in the communication settings menu for transmitters that are configured to communicate more often. [See section 2.5.1.12.](#)

### 7.2.1.2 LOW BATTERY

Indicates the ST-48/RFs integral 3.6V lithium D cell (part # 10-0293) has dropped to below 3.3V and should be replaced very soon. LoBatt is indicated on the ViewSmart 6400's LCD readout and the background color turns red. Relays are not energized by low battery conditions. The actual battery voltage of each ST-48/RF may be seen in the **INPUT DATA FROM** screen described above in [section 7.2.](#)

### 7.2.1.3 CALIBRATIONS

**Calibrations** performed at the ST-48/RF force a transmission of 75 counts (negative 15.62%) which may be indicated on the ViewSmart 6400's LCD readout by In Cal by using the "Marker Menu" described in [section 2.4.4.5.](#) Alarms are inhibited while the "Marker Value" of -15.62% is activated.

## 7.3 WIRELESS MODBUS SLAVE MODE

**Wireless Modbus** allows one or many ViewSmart 6400s to function as wireless Modbus slaves by connecting their RS-485 Modbus slave ports to a radio modem. These wireless networks require a Modbus master such as a DCS, HMI or another ViewSmart 6400 64 Channel Controller; also equipped with a radio modem. As in all R. C. Systems wireless networks, one transceiver must be designated as Server and all others as Clients. No special configuration is required by the *master* or *slave* since this is a standard Modbus RTU network. However, radios must have the same **Hop Channel** and **System ID** settings to communicate.

The entire ViewSmart 6400 Modbus database, including registers and supported Function Codes, is documented in [section 5.3.](#)

## 7.4 WIRELESS MODBUS MASTER MODE

ViewSmart 6400 applications as a "Wireless Modbus master" are similar to the "Wireless Monitor" mode described in [section 7.2](#) and wiring to the radio modem is identical. The radio setup menus described in [section 7.1](#) may also be used for configuring hop channel and system ID settings. The difference is each Channel's **INPUT DATA FROM** menu must be configured with the correct **MODBUS** values to match the slave device instead of **Wireless Monitor**. Wired and wireless inputs may

be mixed between the ViewSmart 6400's 64 channels so it is also possible to accept wired signals from analog input option PCB's described in [section 3.2](#).

This is a popular application when the Modbus slave is another remote ViewSmart 6400, ST-71 or our ST-90/QUAD controller available with built in radio modem compatible with the ViewSmart 6400 Radio Kit. Other Modbus slave devices may also be converted to wireless by addition of another Radio Kit at the slave's location.

## **7.5 ANTENNA SELECTION**

### **7.5.1 DIPOLE AND COLLINEAR ANTENNAS**

These antennas are connected to the Radio via a length of coax cable. If the cable is larger than 6mm diameter (1/4 inch), do not connect the cable directly to the radio connection on the ViewSmart 6400 enclosure. Thick cables have large bending radii and sideways force on the connector can cause a poor connection. Use a short flexible pigtail between the thick cable and the radio.

The polarity of these antennas is the same as the main axis, and they are normally installed vertically. They can be mounted horizontally (horizontal polarity), however the antenna at the other end of the wireless link would need to be mounted perfectly parallel for optimum performance. This is very difficult to achieve over distance. If the antenna is mounted vertically, it is only necessary to mount the other antennas vertically for optimum "coupling" – this is easy to achieve.

Dipole and collinear antennas provide best performance when installed with at least 1 to 2 "wavelengths" clearance of walls or steelwork. The wavelength is based on the frequency:

Wavelength in meters =  $300 / \text{frequency in MHz}$

Wavelength in feet =  $1000 / \text{frequency in MHz}$

Therefore, 900 MHz antennas require at least 2/3 meter (2 feet) and 2.4GHz 15 cm (6 inches). Antennas may be mounted with less clearance but radiation will be reduced. If the radio path is short this won't matter. It is important the antenna mounting bracket to well connected to "earth" or "ground" for good lightning surge protection.

### **7.5.2 YAGI ANTENNAS**

Yagi antennas are directional along the central beam of the antenna. The folded element is towards the back and the antenna should be "pointed" in the direction of the transmission. Yagis should also be mounted with at least 1 to 2 wavelengths of clearance from other objects. The polarity of the antenna is the same as the direction of

the orthogonal elements. For example, if the elements are vertical the Yagi transmits with vertical polarity.

In networks spread over wide areas, it is common for a central unit to have an omni-directional antenna and the remote units to have Yagi antennas. In this case, as the omni-directional antenna will be mounted with vertical polarity, then the Yagis must also have vertical polarity. Care needs to be taken to ensure the Yagi is aligned correctly to achieve optimum performance.

Two Yagis can be used for a point-to-to link. In this case they can be mounted with the elements horizontally to give horizontal polarity. There is a large degree of RF isolation between horizontal and vertical polarity (approx  $-30\text{dB}$ ) so this installation method is a good idea if there is a large amount of interference from another system close by transmitting vertical polarity.

An important mounting tip – if a Yagi has drainage holes in the dipole element, do not mount the antenna with the drainage holes.

### **7.5.3 MOUNTING NEAR OTHER ANTENNAS**

Avoid mounting your network's antenna near any other antenna even when the other antenna is transmitting on a different radio band. High RF energy of the transmission from a close antenna can "deafen" a receiver. This is a common cause of problems with wireless systems.

Because antennas are designed to transmit parallel to the ground rather than up or down, vertical separation between antennas is a lot more effective than horizontal separation. If mounting near another antenna cannot be avoided, mounting it beneath or above the other antenna is better than mounting beside it. Using different polarity to the other antenna (if possible) will also help to isolate the RF coupling.

### **7.5.4 COAX CABLES**

If a coax cable connects to the antenna via connectors, it is very important to weatherproof the connection using our 1000-2314 or equivalent sealing tape. Moisture ingress into a coax cable connection is the most common cause of problems with antenna installations. A three layer sealing process is recommended – an initial layer of electrical PVC tape, followed by a second layer of self-vulcanizing weatherproofing tape (1000-2314), with a final layer of electrical PVC tape.

Allowing a drip "U loop" of cable before the connection is also a good idea. The loop allows water to drip off the bottom of the U instead of into the connection, reduces

installation strain and provides spare cable length in case later the original connectors need to be removed, the cable cut back and new connectors fitted.

Avoid installing coax cables together in long parallel paths. Leakage from one cable to another has a similar effect as mounting an antenna near another antenna.

## **7.6 SURGE PROTECTION & GROUNDING**

Voltage surges can enter the ViewSmart 6400 via the antenna connection, power supply connection, connections to other equipment and even the “earth” or “ground” connection. Surges are electrical energy following a path to earth and the best protection is achieved by “draining” the surge energy to earth via an alternate path. Wireless devices need to have a solid connection to earth via a ground stake or ground grid if the soil has poor conductivity. Solid connection means a large capacity conductor (not a small wire) with no coils or sharp bends. All other devices connected to the ViewSmart 6400 need to be grounded to the same ground point. There can be significant resistance between different ground points leading to very large voltage differences during lightning activity. As many wireless units are damaged by earth potential surges due to incorrect grounding as direct surge voltage.

It is very difficult to protect against direct lightning strikes but the probability of a direct strike at any one location is very small. Unfortunately, power line surges and electromagnetic energy in the air can induce high voltage surges from lightning activity several miles away.

### **7.6.1 ANTENNA GROUNDING**

Electromagnetic energy in the air will be drained to ground via any and every earth path. An earth path exists between the antenna and the ViewSmart 6400 and to protect against damage this earth path current must be kept as small as possible. This is achieved by providing better alternate earth paths. It is important to ground the antenna to the same ground point as the ViewSmart 6400. Antennas are normally mounted to a metal bracket which should be grounded to the ViewSmart 6400 earth connection. Surge energy induced into the antenna will be drained first by the mount's ground connection, second by the outside shield of the coax cable to the ground connection on the radio and third by the internal conductor of the coax cable via the radio electronics. This third earth path causes damage unless the other two paths provide a better earth connection allowing surge energy to bypass the electronics.

When an antenna is located outside of a building and outside of an industrial plant environment, external coax surge diverters are recommended to further minimize the effect of surge current in the inner conductor of the coax cable.

Coax surge diverters have gas-discharge element which breaks down in the presence of high surge voltage and diverts any current directly to a ground connection. A surge diverter is not normally required when the antenna is within a plant or factory environment, as the plant steelwork provides multiple parallel ground paths and good earthing will provide adequate protection without a surge diverter.

### ***Connections to other equipment***

Surges can enter the wireless unit from connected devices, via I/O, serial or Ethernet connections. Other data devices connected to the wireless unit should be well grounded to the same ground point as the wireless unit.

Special care needs to be taken where the connected data device is remote from the wireless unit requiring a long data cable. As the data device and the wireless unit cannot be connected to the same ground point, different earth potentials can exist during surge conditions.

There is also the possibility of surge voltages being induced on long lengths of wire from nearby power cables. Surge diverters can be fitted to the data cable to protect against surges entering the wireless unit.

The same principle applies to I/O device is not close to the wireless unit, the risk of surge increases. Surge diverters for I/O wiring are available to protect the wireless unit.



## SECTION 8 WEBPAGE

All ViewSmart 6400 controllers come standard with an embedded webpage. The webpage gives remote access to view and configure parameters inside the controller. There are two levels of security clearance. The first level allows the user to view channel status and configuration while the second level allows the user to change configuration parameters directly from the computer.

The webpage requires a modern web browser. Supported browsers include Internet Explorer 8\*, Google Chrome, or Mozilla Firefox 2+. Viewing pages in an outdated browser will result in improperly drawn pages.

In order to view the webpage first the user must know the IP address or, if DHCP enabled, the controller's hostname. This information can be viewed from the Network Settings menu ([see section 2.5.3](#)). Once the name or address is entered into a browser a pop up box ask the user for the username and password. The name and password are fixed. The **NAME: admin** and the **PASSWORD: controller64**. After access is gained the user will be able to see channel data, event logs and configuration. If a parameter needs to be changed the user must login before the controller will accept the change. This login password can be changed in the Security menu under Modbus Lock Code ([see section 2.6.3](#)). The default Modbus Lock Code is **1234**.

\* Internet Explorer does not allow access to hostnames that contain a '\_' character.

### 8.1 SYSTEM SCREEN

The System screen shown below (Figure 8-1) displays all active channels at once. It is capable of displaying 16, 32, 48 or 64 channels depending on the controller's configuration. This screen, very similar to the Main Data screen, displays measurement name and uses a colored cells that flash with new alarms to indicate alarm conditions.

Once the alarms have been acknowledged by an operator the cell will remain the appropriate color but will stop flashing, showing the alarm has been acknowledged.

The five standard relays states are shown at the bottom of the screen. The boxes duplicate the LED behavior as seen when looking at the unit. A flashing box indicates an unacknowledged relay, a red box indicates an energized (de-energized for failsafe) relay.

While in the System screen, use the mouse to click on any cell to go directly to that channel's individual data screens. The unused channels are grayed out when turned off.

Viewing only channels belonging to a certain zone can be enabled using the zone drop down box. Selecting a zone will cause channels belonging to other zones to dim.

The System screen is updated automatically every 15 seconds.

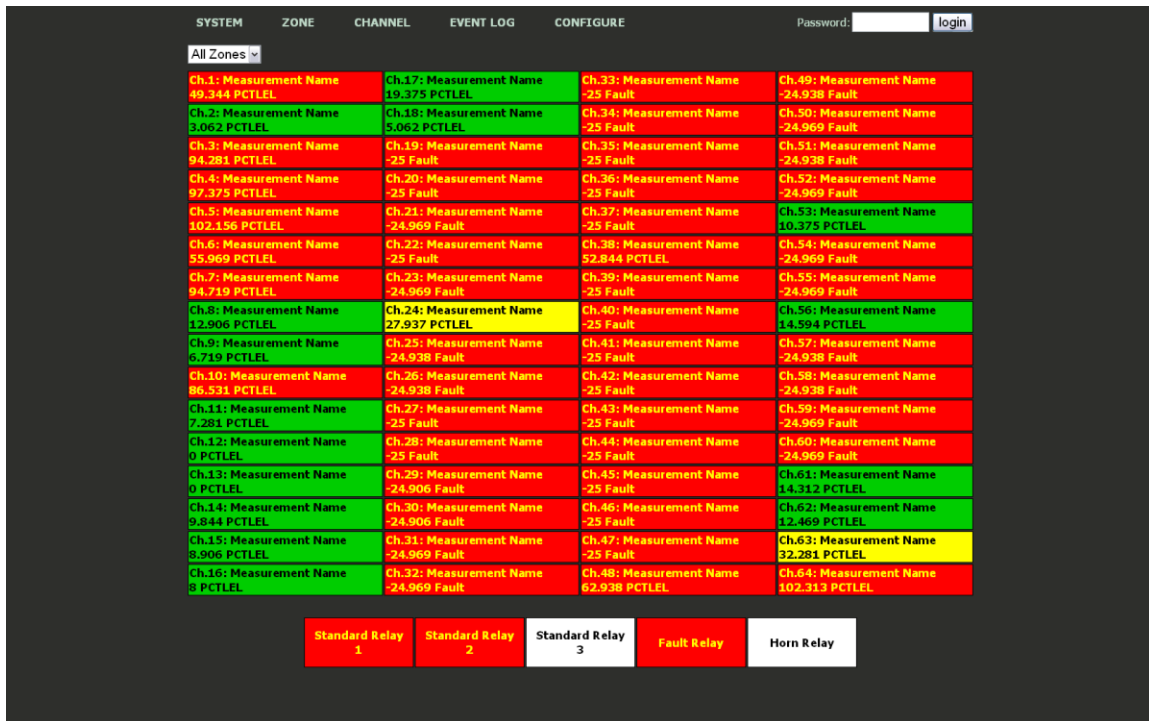

Figure 8-1

## 8.2 ZONE SCREEN

The webpage's Zone screen (Figure 8-2) displays the eight possible zones simultaneously [see section 1.3.5](#). If an alarm condition occurs the user will be able to quickly see in what zone the situation is occurring. Each active zone is divided into alarm levels which are green until an alarm is present. Inactive zones and alarm levels are grayed out. If an alarm should occur, the zone name field will flash and the corresponding box in the assigned zone will turn the color of the alarm that is present or alternate if two different colors are present. Once the alarm has been acknowledged the name field will stop flashing.

To display all the channels included in any zone, use the mouse to click that zone box. The System screen will appear with all the channels that are included in the selected zone displayed in color and the channels that are not in the selected zone dimmed.

The zone screen is updated automatically every 15 seconds.



Figure 8-2

### 8.3 CHANNEL SCREEN

The Channel screen shown in Figure 8-3 displays a 24 hour trend of input data for the channel selected. Vertical tic marks are each hour and horizontal tic marks are each 10% of full scale. Colored lines indicate alarm levels. Since each data point must be collected for several minutes before it may be displayed, it is likely input values will fluctuate during this interval. Therefore, MAX, MIN and AVERAGE values are stored in the controller for each subinterval. Checking the Min, Max and Avg box in the lower left corner turns the respective lines on and off. If there is no trend data available, the corresponding section of the graph will be grayed out. This will occur on power interruptions.

The top portion of each trend screen indicates channel number, real time reading in engineering units, and measurement name. When a channel reaches alarm state, the colored bar changes to the color that represents that alarm level and flashes. Once the alarm is acknowledged the bar stops flashing.

The top portion of the page updates automatically every 15 seconds. The trend is updated when a channel is changed or the 'Refresh Trend' button is pressed.

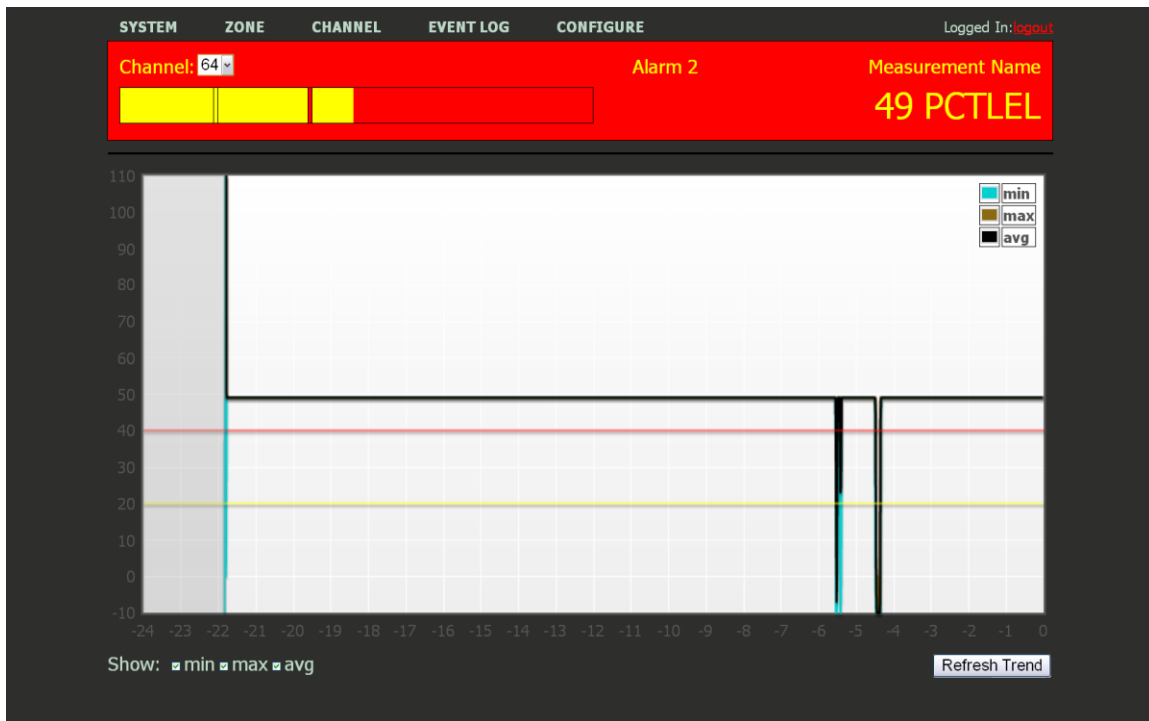
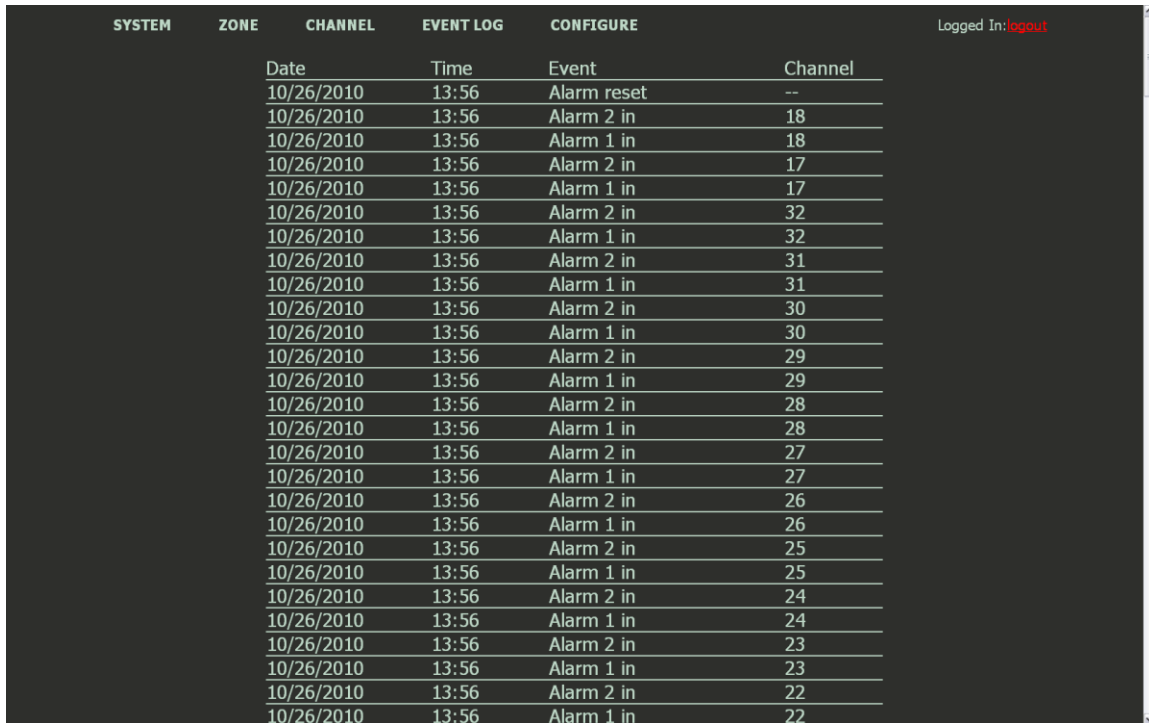

Figure 8-3

## 8.4 EVENT LOG SCREEN

Displays the last 2000 events logged in the ViewSmart 6400. The events are logged in a first in first out format, in non-volatile memory so a SD card is not necessary to view the event log. These events include Alarms In and Out, Alarm Resets, Calibrations, System and Cold Boots, and Communication and Configuration Error. The events are time and date stamped and if channel specific the number is shown in the right column in Figure 8-4.



SYSTEM	ZONE	CHANNEL	EVENT LOG	CONFIGURE
			Date	Time
			Event	Channel
			10/26/2010	13:56
			Alarm reset	--
			10/26/2010	13:56
			Alarm 2 in	18
			10/26/2010	13:56
			Alarm 1 in	18
			10/26/2010	13:56
			Alarm 2 in	17
			10/26/2010	13:56
			Alarm 1 in	17
			10/26/2010	13:56
			Alarm 2 in	32
			10/26/2010	13:56
			Alarm 1 in	32
			10/26/2010	13:56
			Alarm 2 in	31
			10/26/2010	13:56
			Alarm 1 in	31
			10/26/2010	13:56
			Alarm 2 in	30
			10/26/2010	13:56
			Alarm 1 in	30
			10/26/2010	13:56
			Alarm 2 in	29
			10/26/2010	13:56
			Alarm 1 in	29
			10/26/2010	13:56
			Alarm 2 in	28
			10/26/2010	13:56
			Alarm 1 in	28
			10/26/2010	13:56
			Alarm 2 in	27
			10/26/2010	13:56
			Alarm 1 in	27
			10/26/2010	13:56
			Alarm 2 in	26
			10/26/2010	13:56
			Alarm 1 in	26
			10/26/2010	13:56
			Alarm 2 in	25
			10/26/2010	13:56
			Alarm 1 in	25
			10/26/2010	13:56
			Alarm 2 in	24
			10/26/2010	13:56
			Alarm 1 in	24
			10/26/2010	13:56
			Alarm 2 in	23
			10/26/2010	13:56
			Alarm 1 in	23
			10/26/2010	13:56
			Alarm 2 in	22
			10/26/2010	13:56
			Alarm 1 in	22

Figure 8-4

## 8.5 CONFIGURE

The configuration pages allow viewing and editing of most system parameters. The exceptions are communication and security settings which must be set from the unit's

keypad interface. All changes made to the configuration parameters will not be saved until the user has entered the correct login password.

### 8.5.1 ALARM OUTPUTS

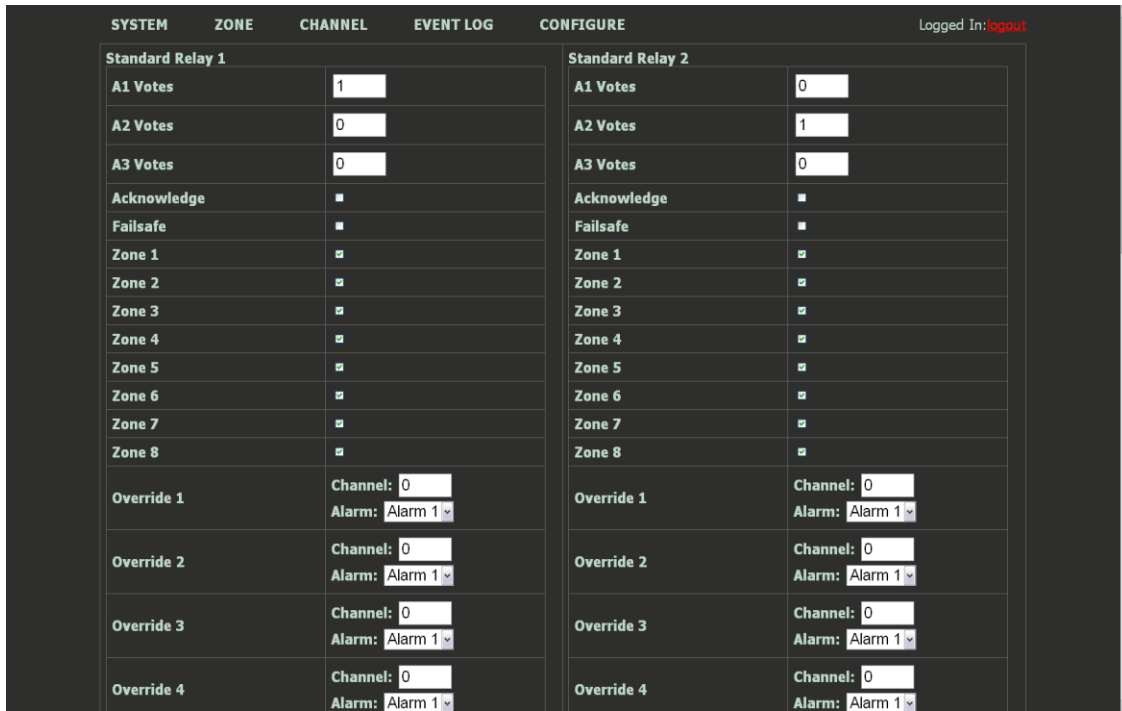

Figure 8-5

## 8.5.2 CHANNEL CONFIGURATION

SYSTEM	ZONE	CHANNEL	EVENT LOG	CONFIGURE
Channel: 1				
<b>Alarm 1</b>				
Setpoint		20.000		
Latching		<input type="checkbox"/>		
Trip On		High		
On Delay (seconds)		0		
Off Delay (minutes)		0		
Horn Drive		<input type="checkbox"/>		
<b>Alarm 2</b>				
Setpoint		40.000		
Latching		<input type="checkbox"/>		
Trip On		High		
On Delay (seconds)		0		
Off Delay (minutes)		0		
Horn Drive		<input type="checkbox"/>		
Color		Red		
<b>Alarm 3</b>				
Enabled		<input type="checkbox"/>		
Setpoint		60.000		
Latching		<input type="checkbox"/>		
<b>Configure</b>				
Channel Enabled		<input checked="" type="checkbox"/>		
Tag		Measurement Name		
Engineering Units		PCTLEL		
Zero		0.000		
Span		25.000		
Decimal Places		0		
Zone		Zone 1		
Deadband		1.000		
<b>Data From</b>				
Source		Analog Input		
Min Raw		800		
Max Raw		4000		
Filter Sample Count		10		
Local Cal		On		
<b>Fault</b>				
Fault Level		-2.500		

Figure 8-6

### 8.5.3 COPY CHANNELS

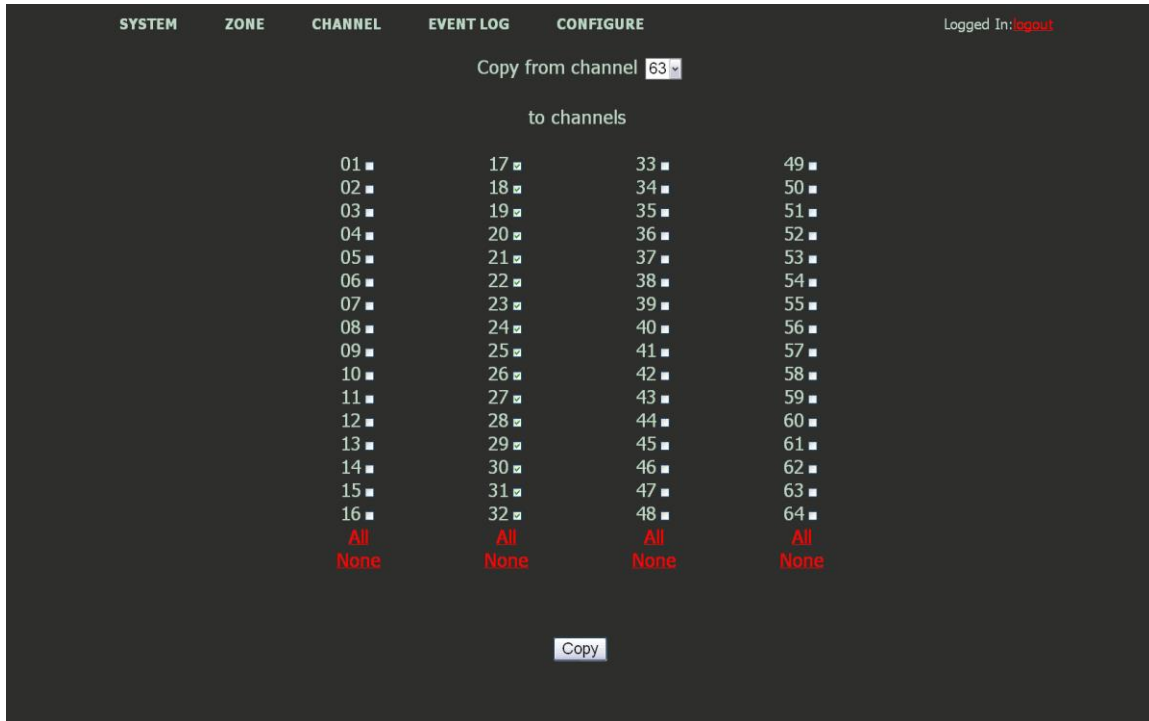

Figure 8-7



### 8.5.4 PROGRAMMABLE RELAYS

SYSTEM    ZONE    CHANNEL    EVENT LOG    CONFIGURE    Logged In: [logout](#)

Programmable Relay 1 ▾

**Programmable Relay board not found.**

A1 Votes	<input type="text" value="1"/>	Override 1	Channel: <input type="text" value="0"/> Alarm: Alarm 1 ▾
A2 Votes	<input type="text" value="0"/>	Override 2	Channel: <input type="text" value="0"/> Alarm: Alarm 1 ▾
A3 Votes	<input type="text" value="0"/>	Override 3	Channel: <input type="text" value="0"/> Alarm: Alarm 1 ▾
Acknowledge	<input type="checkbox"/>	Override 4	Channel: <input type="text" value="0"/> Alarm: Alarm 1 ▾
Failsafe	<input type="checkbox"/>	Override 5	Channel: <input type="text" value="0"/> Alarm: Alarm 1 ▾
Zone 1	<input checked="" type="checkbox"/>	Override 5	Channel: <input type="text" value="0"/> Alarm: Alarm 1 ▾
Zone 2	<input checked="" type="checkbox"/>	Override 7	Channel: <input type="text" value="0"/> Alarm: Alarm 1 ▾
Zone 3	<input checked="" type="checkbox"/>	Override 8	Channel: <input type="text" value="0"/> Alarm: Alarm 1 ▾
Zone 4	<input checked="" type="checkbox"/>		
Zone 5	<input checked="" type="checkbox"/>		
Zone 6	<input checked="" type="checkbox"/>		
Zone 7	<input checked="" type="checkbox"/>		
Zone 8	<input checked="" type="checkbox"/>		

Figure 8-8

## 8.5.5 SYSTEM CONFIGURATION

SYSTEM	ZONE	CHANNEL	EVENT LOG	CONFIGURE	Logged In: <a href="#">logout</a>
System Config:			Zone Names:		
Name	Unit-72-1000		Zone 1 Name	Zone 1	
Date	10	/ 26 / 2010	Zone 2 Name	Zone 2	
Time	14	: 1 : 38	Zone 3 Name	Zone 3	
Channel Count	64		Zone 4 Name	Zone 4	
Cal Purge Time (min)	1		Zone 5 Name	Zone 5	
Warmup Time (min)	1		Zone 6 Name	Zone 6	
Zone Screen Enabled	<input checked="" type="checkbox"/>		Zone 7 Name	Zone 7	
Block Negative	<input checked="" type="checkbox"/>		Zone 8 Name	Zone 8	
<input type="button" value="Save"/>					

Figure 8-9

## 8.5.6 Email Configuration

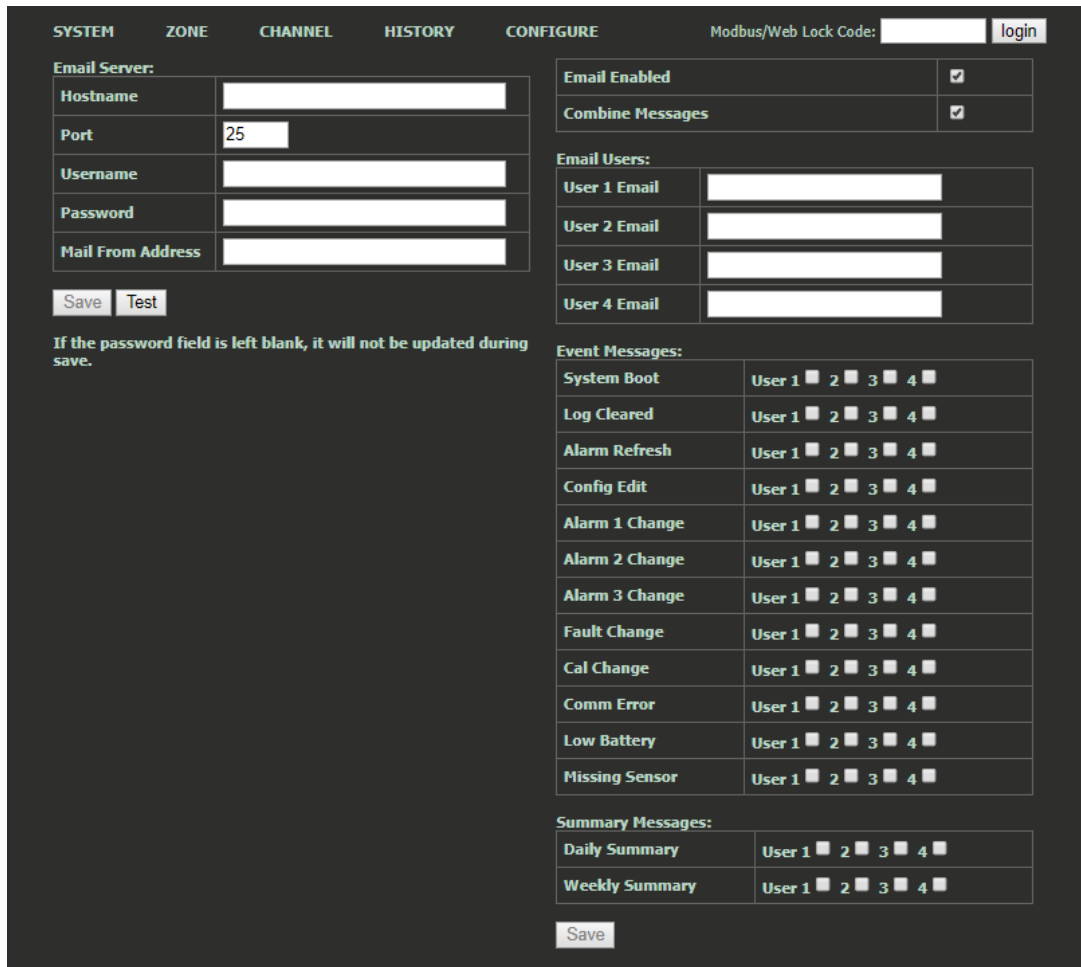

The screenshot shows the 'CONFIGURE' tab of the ViewSmart 6400 web interface. At the top, there are navigation tabs: SYSTEM, ZONE, CHANNEL, HISTORY, and CONFIGURE. To the right of these tabs is a 'Modbus/Web Lock Code:' field with a 'login' button. Below the tabs, the 'Email Server' section contains fields for Hostname, Port (set to 25), Username, Password, and Mail From Address. There are 'Save' and 'Test' buttons below these fields. A note states: 'If the password field is left blank, it will not be updated during save.' To the right of the Email Server section, there are checkboxes for 'Email Enabled' and 'Combine Messages', both of which are checked. Below these are the 'Email Users' fields, labeled 'User 1 Email' through 'User 4 Email'. The 'Event Messages' section contains a table with event types and checkboxes for each of the four users. The 'Summary Messages' section contains a table with 'Daily Summary' and 'Weekly Summary' and checkboxes for each of the four users. A 'Save' button is located at the bottom of the form.

Event Messages:	User 1	2	3	4
System Boot	<input type="checkbox"/>	<input type="checkbox"/>	<input type="checkbox"/>	<input type="checkbox"/>
Log Cleared	<input type="checkbox"/>	<input type="checkbox"/>	<input type="checkbox"/>	<input type="checkbox"/>
Alarm Refresh	<input type="checkbox"/>	<input type="checkbox"/>	<input type="checkbox"/>	<input type="checkbox"/>
Config Edit	<input type="checkbox"/>	<input type="checkbox"/>	<input type="checkbox"/>	<input type="checkbox"/>
Alarm 1 Change	<input type="checkbox"/>	<input type="checkbox"/>	<input type="checkbox"/>	<input type="checkbox"/>
Alarm 2 Change	<input type="checkbox"/>	<input type="checkbox"/>	<input type="checkbox"/>	<input type="checkbox"/>
Alarm 3 Change	<input type="checkbox"/>	<input type="checkbox"/>	<input type="checkbox"/>	<input type="checkbox"/>
Fault Change	<input type="checkbox"/>	<input type="checkbox"/>	<input type="checkbox"/>	<input type="checkbox"/>
Cal Change	<input type="checkbox"/>	<input type="checkbox"/>	<input type="checkbox"/>	<input type="checkbox"/>
Comm Error	<input type="checkbox"/>	<input type="checkbox"/>	<input type="checkbox"/>	<input type="checkbox"/>
Low Battery	<input type="checkbox"/>	<input type="checkbox"/>	<input type="checkbox"/>	<input type="checkbox"/>
Missing Sensor	<input type="checkbox"/>	<input type="checkbox"/>	<input type="checkbox"/>	<input type="checkbox"/>

Summary Messages:	User 1	2	3	4
Daily Summary	<input type="checkbox"/>	<input type="checkbox"/>	<input type="checkbox"/>	<input type="checkbox"/>
Weekly Summary	<input type="checkbox"/>	<input type="checkbox"/>	<input type="checkbox"/>	<input type="checkbox"/>

Figure 10 Webpage Email Configuration Menu

### 8.5.6.1 Email Capabilities

#### 8.5.6.1.1 Connection Capabilities

The email client uses ESMTP protocol to connect to a mail server. The user must provide their own mail server and sending account.

#### 8.5.6.1.2 TLS (Transport Layer Security) Certificates

Implicit TLS (SSL) can be selected if the server expects a TLS connection to be opened. The default certificate processing does not validate server certificates with a certificate authority.

The email client will connect to the server using Implicit TLS (SSL). This is typically port 465. The email client will not connect to an unencrypted port (port 25) or send a STARTTLS command.

### 8.5.6.1.3 Users

- Up to 4 destination email users may be configured.
- Each email trigger can be programmed to send to any of all of the 4 users.
- Email addresses are limited to 40 characters

### 8.5.6.1.4 Events

Any system event can trigger an email. These are the same events that are entered into the event log. Event emails provide a predefined set of information relating to the event. For events such as alarms which have an in/out state event, the subscription will trigger both in and out type event emails.

### 8.5.6.1.5 Relay States

Changes to any standard or programmable relay can trigger an email. Emails are sent when the state of the relay changes. Programmable relay emails can be configured even if the relay option is not installed in the system. These settings are configured on the relay configuration web pages.

The subject and body are both customizable

- Subject length is limited to 19 characters in addition to 16 characters for system name
- Body length is limited to 129 characters

### 8.5.6.1.6 Summaries

Summary emails combine up to 50 system events into a single email. If more than 50 events occur in this period, only the last 50 are sent.

- Daily summary sends at midnight.
- Weekly summary sends at midnight on Saturday

### 8.5.6.1.7 Combined Messages

This option will merge emails per user if multiple events or relays trigger rapidly. Combining messages will reduce the number of emails a user receives in these situations. This option is recommended unless the emails are forwarding to a SMS text messaging address. Up to 20 events may be merged into a single email

### 8.5.6.1.8 Text Messaging

Emails can typically be forwarded to a SMS text message. This is accomplished by using the cellular provider's email forwarding address for an email user. An example for a Verizon customer is [4095550100@vtext.com](mailto:4095550100@vtext.com)

### 8.5.6.1.9 Discarded Messages

In some situations, emails will be discarded. The following cases may cause an email to not be sent.

- **Rapid email triggers:** If emails are being triggered more rapidly than they can be sent, only 50 messages may be queued at once. Once 50 messages are queued, the oldest messages will be replaced by newer messages. The messages will be sent from the queue in the order they occurred. This is only likely if the connection to the server is very slow.
- **Combined email limits:** If the combined email option is selected and the total length of the combined email is more than 2048 characters, the message will be truncated.
- **Email Server Connection Error:** If the email server connection is giving errors then all pending messages will be discarded. This only applies to server or authentication errors. Errors such as DNS timeout or SMTP timeout will result in a retry and the messages will not be discarded

### 8.5.6.2 Email Server Setup

To configure the email function included with the ViewSmart 6400 it is first required to enter information about the outbound email server you will be using.

Hostname is the name of the host server of the outgoing email server you will be using (e.g. smtp.gmail.com for Gmail's SMTP server). Check with your email service provider for more details. The Port is the server port that will be used.

Username and Password are the Username and Password associated with the email address that will be sending the emails (e.g. Username: [outgoingemail@gmail.com](mailto:outgoingemail@gmail.com) password: Password).

Once these settings are entered, click Save.

Click Test to ensure the configuration is working properly.

### 8.5.7 Email Setup

1. Check the Email Enabled checkbox to enable the email function
2. Check the Combine Messages checkbox to combine multiple emails into a single email
3. Assign up to four email recipients by entering their email addresses in the Email Users fields
4. Check the Event Message Box associated with the users who need to receive email notifications for the associated events
5. Check the Summary Message Box associated with the users who need to receive email summaries of events daily and/or weekly
6. Configure emails for relay states on the Alarm Outputs configuration page and the Programmable Relay configuration page

### 8.5.8 CONFIGURATION UPLOAD/DOWNLOAD

The configuration upload/download page allows transferring system configuration to or from the unit via the webpage. When the download link is clicked, the unit saves the current configuration into a file and transfers it to the user. It should be saved as a .cfg file. When uploading configuration, select a .cfg file and press upload. Note that the maximum length of a filename for an uploaded file is 28 characters. After a successful upload, the unit will restart and the webpage will attempt to refresh after 30 seconds.

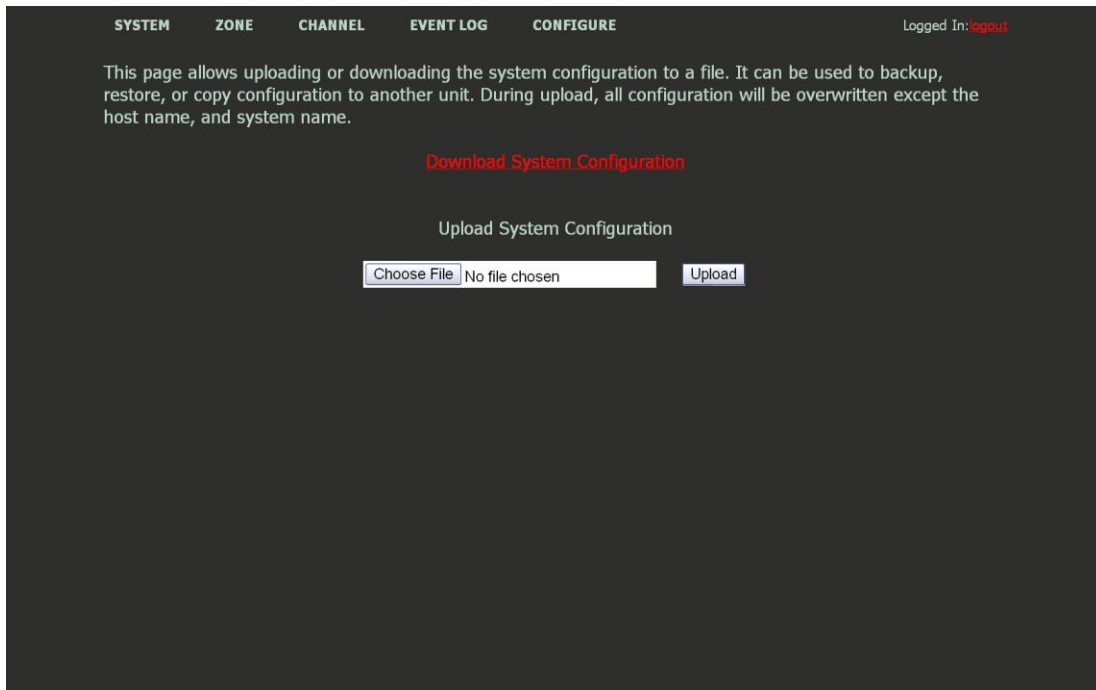

Figure 8-11

## SECTION 9 TROUBLESHOOTING

### 9.1 CHANNEL ERRORS

The following errors indicate potential hardware or configuration problems. If an error occurs, a message is displayed for that channel.

#### 9.1.1 COMM ERROR

Comm Error can occur for Modbus or wireless channels. This error indicates the data was not received. Comm Error can indicate a timeout or an invalid reply from a device. Check communication settings for the port used as well as the **Data from** menu for that channel. The ports themselves can be tested from the **Diagnostics** menu.



#### 9.1.2 CONFIG ERROR

Config error can occur for Modbus or wireless channels only. This error indicates that the Interface selected is configured for something else. For example, if **COM1** is set to Modbus slave and a channel 1 is set with a **Source** of **Modbus 16bit** and an **Interface** of **COM1**. To correct this, either edit the COM port in **Communication Settings** menu or edit the channel's **Interface** in the **Data From** menu.

#### 9.1.3 I/O ERROR

I/O Error indicates a problem communicating with the analog input boards. This error will affect an entire group of 16 channels at a time, assuming they are all setup for analog input. Check wiring from the Main I/O Board to the affected Analog Input board. Verify that the analog input board is setup to for the correct channel group. Only a single input board in a system can be set to use each channel group. See **I/O Board Config** in the **Diagnostics** Menu.

### 9.2 RESET TO FACTORY DEFAULTS

All ViewSmart 6400 configuration can be reset to factory defaults at once. This is done through the **Coldboot** menu shown in Figure 9-1. To access the Coldboot menu, hold the  and cycle power. The  can be released once the *Loading Configuration Data* progress bar appears. If a SD Card is installed, this menu will allow backing up the

current configuration before starting the Coldboot. If only one channel's configuration needs to be reset refer to [section 2.4.6.9](#).

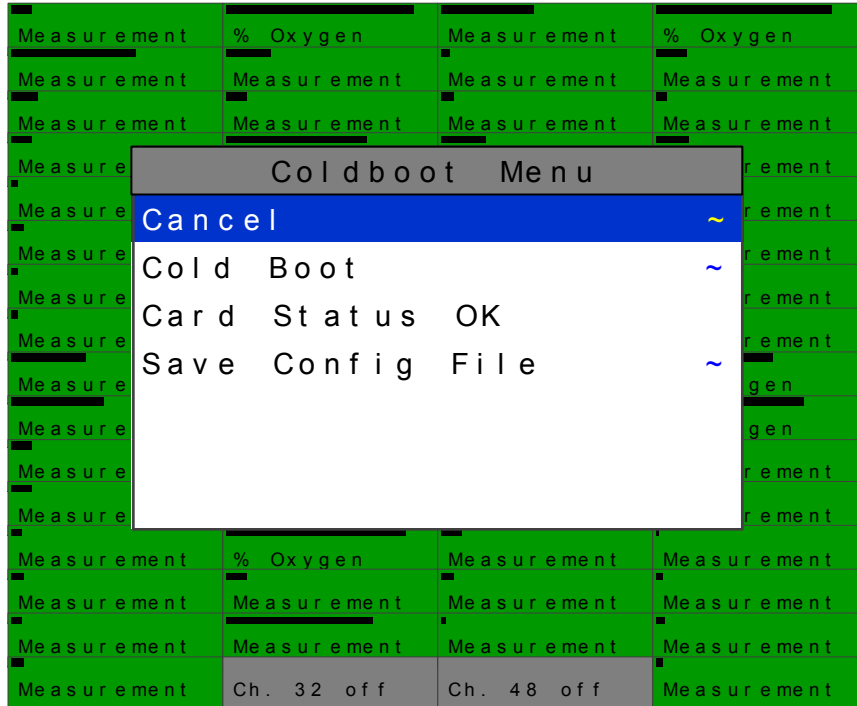

Figure 9-1



## SECTION 10 NETWORK CONNECTION

### 10.1 DIRECT CONNECTION WITH CROSSOVER CABLE OR HUB/SWITCH

If a network is not available, or if it is desired to keep the ViewSmart 6400 and PC(s) completely separated from other computers, a simple network can be created.

The simplest network can be created by connecting the ViewSmart 6400 to a PC directly using an Ethernet crossover cable. Many modern computers have automatic detection/switching on the port. In most cases a normal patch cable can directly connect the ViewSmart 6400 to a PC.

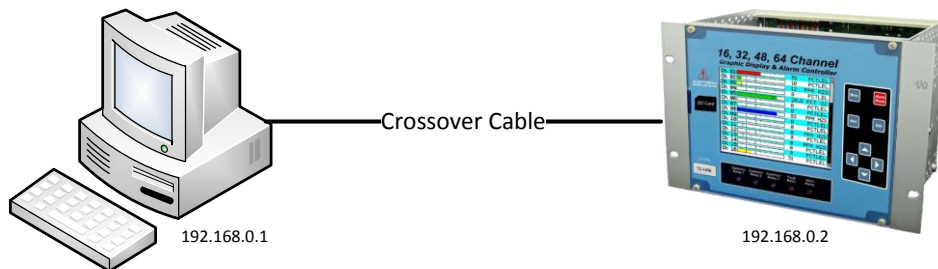

Figure 10-1

If a crossover cable is not available, or if multiple computers need access to the ViewSmart 6400, a switch can be connected to the ViewSmart 6400 and one or more computers using standard patch cables.

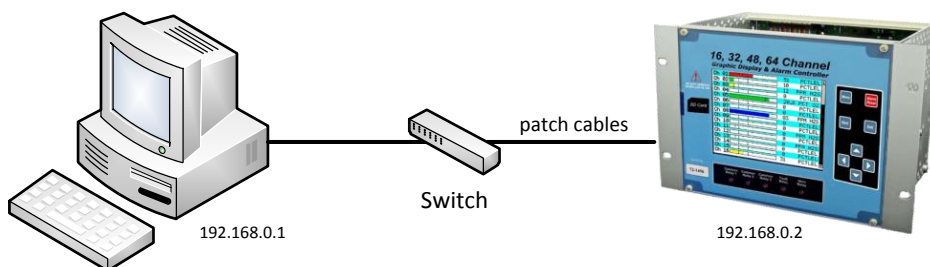

Figure 10-2

These simple networks will not likely have access to a DHCP server. In this case, if the ViewSmart 6400 is configured for DHCP, it will automatically select an IP address on the subnet 169.254.x.x. This subnet uses a netmask of 255.255.0.0 and is compatible with the default IP addresses chosen by Microsoft Windows. If connecting to a new ViewSmart 6400 with firmware version 2.12 or later, no configuration changes will be needed to connect a PC. Simply connect the PC with a patch cable. Then view the

ViewSmart 6400 'Communication Settings'->'Network Settings' menu. The IP address field will show a value which can be entered into the web browser to view the webpage.

The recommended option for a permanent network is to setup a static IP on the ViewSmart 6400 and any other devices (or computers) on the network. [See section 10.4.](#)

## 10.2 CONNECTING THE ViewSmart 6400 TO AN EXISTING LAN

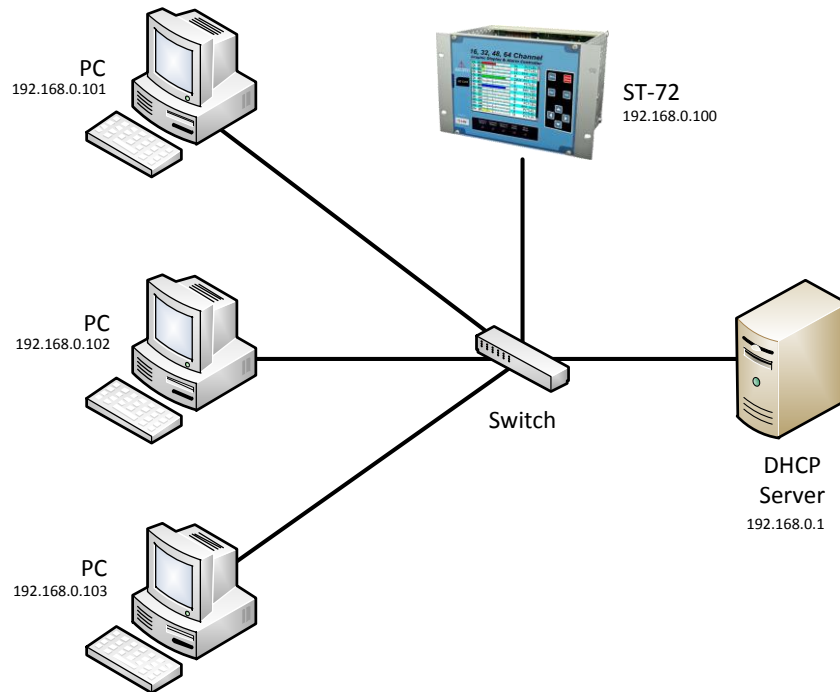

Figure 10-3

A typical network will have a DHCP server, a switch (sometimes combined) and several devices connected to that switch. An ViewSmart 6400 can normally be added to such a network simply by connecting the Ethernet port to the switch using an Ethernet patch cable. The ViewSmart 6400's default settings will allow it obtain an IP address from the DHCP server. Once this happens, the ViewSmart 6400 can be accessed from computers and other devices on the network. Computers access the ViewSmart 6400 by hostname, or by IP address.

If more than one ViewSmart 6400 is on the network, and if they need to communicate with each other, it is recommended to use a static IP configuration ([see section 10.4.](#)). This is because there is a possibility that a dynamic address will be changed by the DHCP server. If the IP address is changed, communication will fail. Static configuration is necessary when using ModbusTCP master or Mimic mode over TCP/IP.

If accessing the ViewSmart 6400 from a computer or other device that can resolve its hostname, dynamic configuration is fine.

### 10.3 CONNECTING THE ViewSmart 6400 ON AN ISOLATED NETWORK

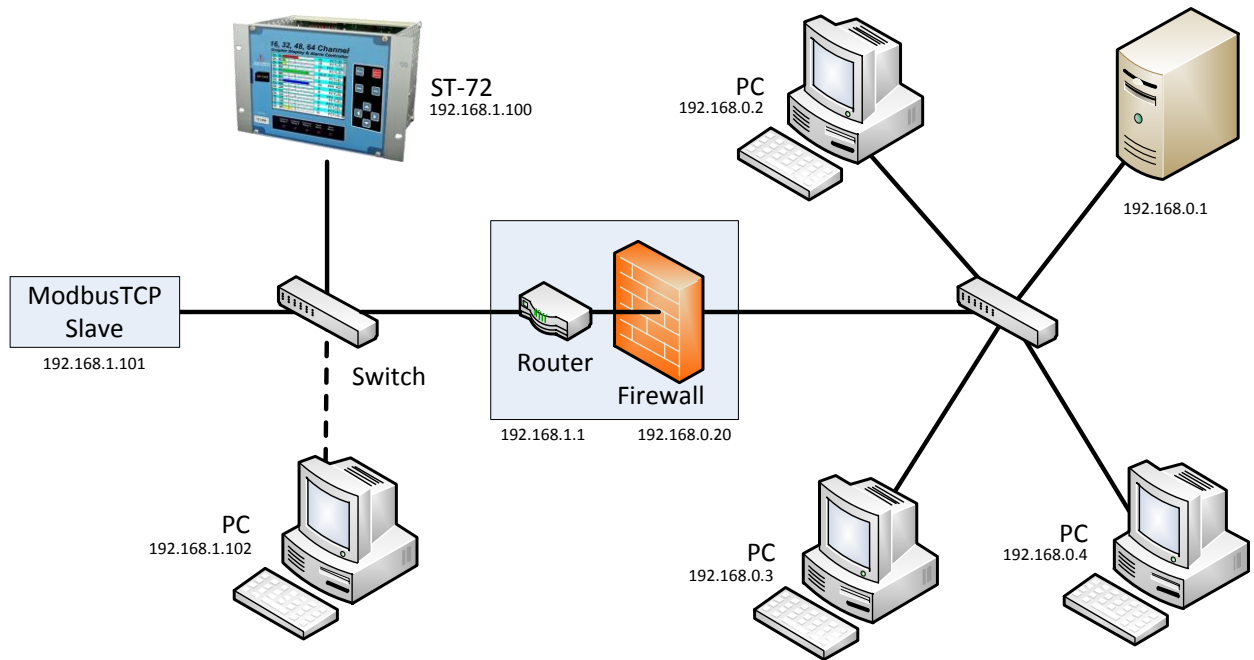

Figure 10-4

Another possible network configuration for the ViewSmart 6400 involves connecting the controller, with ModbusTCP slave devices, and possibly computers on a network. This network can then be isolated from a larger company network using a router/firewall. The isolated network will not see any traffic from the company network unless port forwarding rules are setup in the router. This configuration offers greater security and improved network performance when the company network has a large amount of traffic.

When creating an isolated network, make sure to use a different private IP address range than the outside network. For example; if the main network uses 192.168.0.0 – 192.168.0.255 with a netmask of 255.255.255.0, the isolated network could use 192.168.1.0 – 192.168.1.255 with the same netmask.

Port forwarding rules can usually be configured to only allow certain computers outside the firewall access to the ViewSmart 6400. The method for creating forwarding rules is heavily dependent on the router/firewall being used. See router documentation. The IP

address or MAC address of the source (outside computer), Incoming port, destination (ViewSmart 6400) IP address, destination port, and protocol will need to be set. The source IP address should be set to allow a range or single IP Address. Some firewalls can restrict access by MAC address. This can be used instead of or in addition to the source IP address. The protocols for forwarding rules should be TCP/IP. The destination ports should be 80 for access to the web server, and 502 for access to ModbusTCP.

In most cases, a router and firewall will separate the network from the internet. It is not recommended to forward ports from the internet to an ViewSmart 6400. In cases where offsite access is needed, a VPN or tunnel connection could be used to get inside the network.

## 10.4 STATIC IP CONFIGURATION

If you are setting up static IPs on a larger company network, make sure to consult your IT administrator to obtain an IP address. The IT administrator can also provide the correct netmask, and gateway. In this case, do not choose your own addresses or you could cause an address conflict with other devices on the network.

### 10.4.1 ViewSmart 6400 STATIC IP CONFIGURATION

On the ViewSmart 6400, in the network settings menu, disable DHCP. The IP address should be set to 192.168.0.x where 'x' is any number from 0-255. A typical address would be 192.168.0.2. The netmask should be set to 255.255.255.0. The gateway can be left as 0.0.0.0 unless the ViewSmart 6400 will be accessing ModbusTCP devices outside a router/firewall. If the ViewSmart 6400 needs to poll outside devices, the gateway IP should be set. This is typically the IP address of a router.

Network Settings	
DHCP Enabled	No
Host name	Unit - 72 - 1000
Address	192.168.0.2
Net mask	255.255.255.0
Gateway	0.0.0.0

Figure 10-5



After making changes to the network settings menu a power cycle is required. Make sure to exit the menu before cycling power so that the changes are saved.

### 10.4.2 WINDOWS XP STATIC IP CONFIGURATION

These steps are similar but not exactly the same in other versions of windows.

To connect a PC to a ViewSmart 6400 using static IP configuration, the PC must also be configured. First, access the PC's network adapter settings. In windows XP, this can be found in the control panel -> network connections. Open the network adapter which is usually called 'Local Area Connection'.

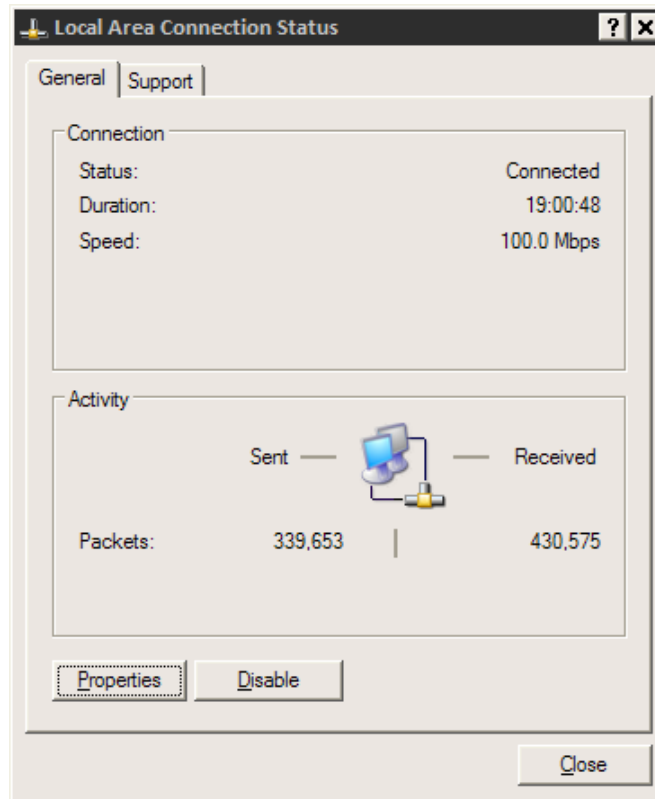

Figure 10-6

Click the properties button.

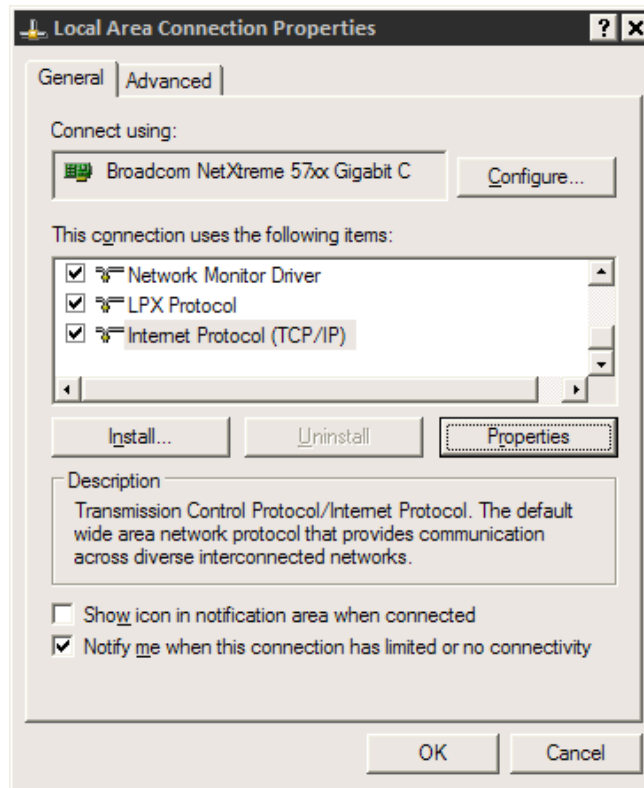

Figure 10-7

Select "Internet Protocol (TCP/IP)", and then click the properties button.

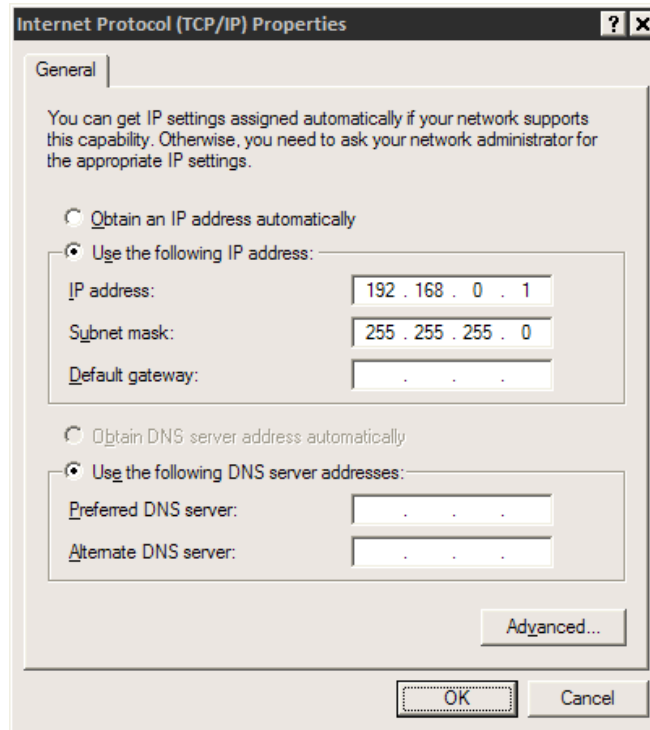

Figure 10-8

Select “Use the following IP Address”. The IP address should be chosen different than the one set on the ViewSmart 6400. For the network created in the ‘ViewSmart 6400 Static IP configuration’, only the last digit can be changed. A typical choice is 192.168.0.1. The Subnet mask is set to 255.255.255.0. If a gateway is present, its address should be set; otherwise it can be left blank. Click OK, and then OK again to apply these changes.

### 10.4.3 DYNAMIC IP CONFIGURATION

The ViewSmart 6400 defaults to use a dynamic IP address. This setting may be used if a DHCP server is available on the network. It is recommended for ViewSmart 6400s unless there are multiple ViewSmart 6400s that need to communicate with each other.

Network Settings	
DHCP Enabled	Yes
Host name	Unit - 72 - 1000
Address	192.168.0.100
Net mask	255.255.255.0
Gateway	192.168.0.1

Figure 10-9

To enable dynamic IP, set DHCP to Yes in the network settings menu. Power must be cycled before this change takes effect. Make sure to exit the menu so the settings are saved before cycling power.

A PC will normally have DHCP enabled by default. If not, follow the steps in [section 10.4.2](#), except choose “Obtain IP address automatically” in the last step.

## 10.5 TESTING CONNECTIONS

To verify that an ViewSmart 6400 is accessible, bring up a command prompt. In windows, this can be found by going to ‘start’ -> ‘run’. Then type ‘cmd’ and press ok. From the command prompt, type ping and then the IP address of the unit. Verify that 4 reply lines are printed.

```
C:\>ping 192.168.0.2

Pinging 192.168.0.2 with 32 bytes of data:

Reply from 192.168.0.2: bytes=32 time<1ms TTL=128
Reply from 192.168.0.2: bytes=32 time<1ms TTL=128
Reply from 192.168.0.2: bytes=32 time<1ms TTL=128
Reply from 192.168.0.2: bytes=32 time<1ms TTL=128

Ping statistics for 192.168.0.2:
    Packets: Sent = 4, Received = 4, Lost = 0 (0% loss),
Approximate round trip times in milli-seconds:
    Minimum = 0ms, Maximum = 0ms, Average = 0ms
```



To test access by hostname: Type ping and then the hostname of the unit.

```
C:\>ping unit-72-1000

Pinging unit-72-1000 [192.168.0.2] with 32 bytes of data:

Reply from 192.168.0.2: bytes=32 time<1ms TTL=128
Reply from 192.168.0.2: bytes=32 time<1ms TTL=128
Reply from 192.168.0.2: bytes=32 time<1ms TTL=128
Reply from 192.168.0.2: bytes=32 time<1ms TTL=128

Ping statistics for 192.168.0.2:
    Packets: Sent = 4, Received = 4, Lost = 0 (0% loss),
    Approximate round trip times in milli-seconds:
        Minimum = 0ms, Maximum = 0ms, Average = 0ms
```

If pinging the hostname fails, but pinging the IP address does not, it may indicate a DNS problem. The command 'ipconfig /flushdns' may help if network settings have been changed recently on the ViewSmart 6400. Otherwise, the webpage can be accessed by IP address rather than hostname.

The web links for the ViewSmart 6400 when using the configuration as shown in [section 10.4.1](#) are <http://192.168.0.2/> or <http://unit-72-1000/>.