

PDCR 800 SERIES

General Purpose Pressure Transducers

- Excellent linearity and hysteresis
±0.1% B.S.L. for ranges to 60 bar
- High overload capability
- Rationalised outputs
- Good thermal stability
±1.5% total error band -20° to +80° C
- Parameter selection available



PDCR 800 SERIES

INTRODUCTION

Every PDCR 800 transducer is based on a high performance pressure sensor (core) which has subsequently been completed for a specific application by the addition of an electron beam welded pressure connector and an electrical connector assembly. The core itself is an accurate pressure transducer incorporating a high integrity silicon diaphragm and titanium module, a pcb assembly and advanced compensation techniques which give excellent performance over extended temperature ranges. The final assembly is electron beam welded and encapsulated. These cores are produced in large quantities and following automatic calibration over the whole temperature range the data is stored in the computer data base.

The benefits are a high performance to cost ratio series of the transducers listed below, including the core which can be selected and adapted in many different ways and supplied on short delivery.

Type Number and Specification

PDCR 800/801 - Basic core
 PDCR 810/811 - General purpose
 PDCR 820/821 - General purpose
 PDCR 830/831 - Depth
 PDCR 860/861 - Integral connector
 This type numbering system denotes the following details:-

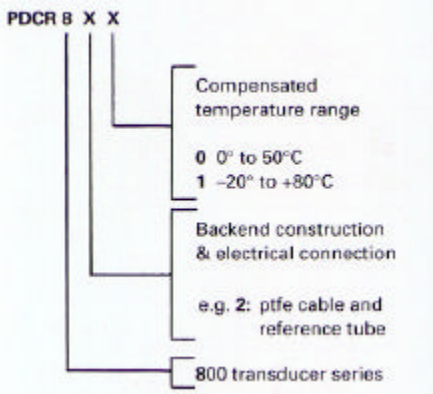

Please refer to temperature effects, ordering information, assembly diagram and installation drawings to fulfil your requirements.

STANDARD SPECIFICATION

Operating Pressure Ranges
 70mbar, 175mbar, 350mbar, 700mbar, 1, 1.5, 2, 3.5, 5, 7, 10, 15, 20, 35 and 60 bar gauge.
Other pressure units can be specified, e.g. psi, kPa, mH₂O.
Absolute, differential and sealed gauge transducers are available.
For higher ranges refer to PDCR 900 data sheet.

Negative Pressure
 All transducers will accurately respond to pressures below gauge (negative pressures) and will operate with a vacuum applied. The reference side of the PDCR 82X is suitable for atmospheric reference pressures only.

Overpressure
 The rated pressure range can be exceeded by the following multiples causing negligible calibration change:-
 10 x for 70 and 175mbar ranges
 6 x for 350mbar range
 4 x for 700 mbar range and above.
 Flush fitting version:-
 35 bar range and above maximum pressure 70 bar.
For differential pressures refer to PDCR 10/L/340 data sheets.

Burst Pressure
 In excess of 10 x rated pressure.

Positive Pressure Media
 Fluids compatible with silicon and titanium.

Reference Pressure Media
 Dry, non-corrosive, non-conducting gases.
For liquid pressure media on reference, refer to PDCR 120/WL data sheet.

Conducting Pressure Media
 When operating with a conducting pressure media use a fully floating system or earth the + Ve supply.
If this method is not practicable please refer to PDCR 900 data sheet.

Transduction Principle
 Integrated silicon strain gauge bridge.

Excitation Voltage
 10 Volts @ 5mA nominal.

Output Voltage
 17mV for 70mbar range
 25mV for 175mbar range
 50mV for 350mbar range
 100mV for 700mbar ranges and above.

The above outputs are for 10 Volts and are proportional to excitation voltage.

For amplified outputs please refer to PDCR 130 data sheet.

Common Mode Voltage
 Typically + 6.5 Volts with respect to the -Ve supply at 10 Volts excitation.

Output Impedance
 2000 ohms nominal.

Load Impedance
 Greater than 100K ohms for quoted performance.

Resolution
 Infinite.

Combined Non-linearity, Hysteresis and Repeatability
 ±0.1%B.S.L. for all ranges.

Zero Offset and Span Setting
 ±3mV maximum.

Operating Temperature Range
 -20° to +80°C standard.

This temperature range can be extended to 125°C for the PDCR 82X and PDCR 86X.

Temperature Effects

PDCR 8X0
 ±0.5% total error band 0° to 50°C for 175mbar ranges and above.
 ±1% total error band 0° to 50°C for 70mbar range.
 PDCR 830±0.6%, -2° to +30°C for 70mbar range, ±0.3%, -2 to +30°C for 175mbar range and above.

PDCR 8X1
 ±1.5% total error band -20° to +80°C for 175mbar ranges and above.
Typical thermal zero and span coefficients of ±0.015%/F.S./°C.
For -54° to +125°C temperature range please refer to PDCR 8X2 product note.

Natural Frequency
 28 kHz for 350mbar increasing to 360 kHz for 35 bar.

For more detailed information please refer to manufacturer.

Acceleration Sensitivity
 0.006% F.S./g for 350mbar decreasing to 0.0002% F.S./g for 35 bar.

Mechanical Shock
 1000g for 1msec half sine pulse in each of 3 mutually perpendicular axis will not affect calibration.

Vibration
 Response less than 0.05% F.S./g at 30g peak 10Hz-2kHz, limited by 12mm double amplitude (MIL-STD 810C Proc 514.2-2 Curve L).

Weight
 100 gms. nominal.

Electrical Connection
 1 metre integral cable supplied.

See ordering information for specification details.
Longer lengths available on request.

6 pin Bayonet fixed plug to MIL-C 26482 or DEF 5325 shell size 10 supplied with PDCR 86X, and mating socket Amphenol type 62GB-16F10-6S supplied as standard.

Pressure Connection
 G¹/₈B 60° Internal cone
 G¹/₈B } Flat End
 1/16" N.P.T. }
 G¹/₈B 60° Internal cone
 7/16" U.N.F. as MS.33656-4
 M12 x 1.5 Ermeto
 M14 x 1.5 mm DIN 3863-8
 Flush fitting
 Depth cone

Others available on request.

Continuing development sometimes necessitates specification changes without notice.

PDCR 800 SERIES: Specification Options

The following summarises the possibilities and for further details and ordering information please contact our Sales Office.

1. Parameter Selection

The PDCR 800 series transducer is calibrated to the nominal full range pressure, and the temperature effects of zero and span are monitored at five temperatures between -20° and +80°C. This information is stored in a computer and enables us, where it is important, to optimise the performance parameters to suite specific applications. Selection can either be for improved performance in accuracy or temperature drift from standard transducers or to optimise certain parameters by using the transducers in the overrange condition.

2. Improved Accuracy

The standard linearity and hysteresis is $\pm 0.1\%$ B.S.L., but this can be improved to $\pm 0.06\%$ B.S.L., or even better by selection. In some cases this may result in a reduction of the full scale output.

3. Higher Overload Pressure

The lowest overload pressure for standard devices is 400% but this can be increased up to 100% where necessary. This will reduce the full scale output and increase the zero drift with temperature unless this is maintained by selection.

4. Higher Output

All cores can be overranged by three times nominal full scale, giving outputs of up to 300mV for most ranges. This will improve the zero stability, reduce the overload, and the linearity will be slightly degraded.

5. Excitation Voltage

The transducers can be operated from any d.c. excitation up to 12 Volts maximum. The output is proportional to excitation, but the exact offset and span should be measured at the desired excitation.

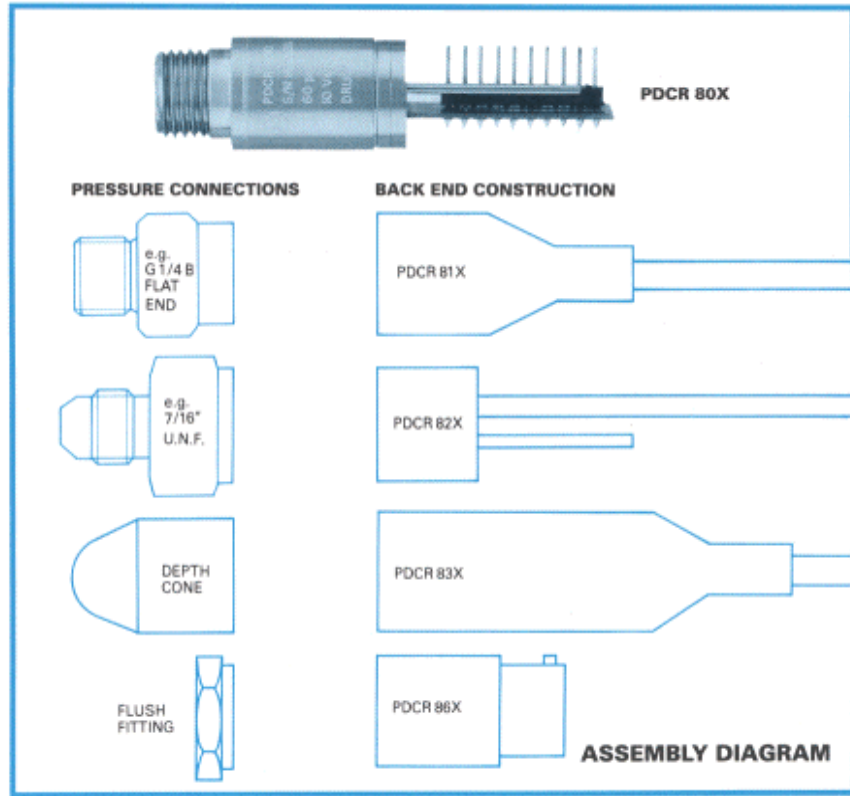

6. Improved Temperature Effects

Improved thermal error bands can be selected from the data base.

e.g. $\pm 0.3\%$ 0° to 50°C
 $\pm 1\%$ -20° to +80°C

Other error bands over different temperature ranges can also be selected.

7. Improved Zero Stability

Thermal zero shift and long term zero stability are improved proportionally with overload.

8. Long Term Stability

The standard PDCR 800 series offers typically 0.2mV per year stability at 10 Volt operation, but this can be improved considerably by operating in the overrange condition at a reduced supply voltage.

9. Thermal Hysteresis

The calibration of a standard transducer at room temperature will repeat within 0.2mV after cycling through the full temperature range.

10. Rationalisation

The transducers can be selected such that both the zero offset and the full scale output are matched to better than 1mV where interchangeability is important.

11. Extended Temperature Range

Transducers are available which will operate between -54° and +125°C.

Please refer to PDCR 82X product note.

12. Rcal

This facility is available by connecting an external resistor across the appropriate connection. The thermal coefficient of this Rcal signal is typically 0.005% F.S./°C.

13. Calibration Print Out

Available on request relating to selected parameters above.

ORDERING INFORMATION

(1). Type number

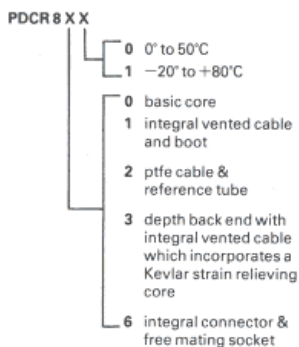

(2). Operating pressure range

(3). Pressure connection

(4). Pressure media

For non-standard requirements please specify in detail.

Examples of alternative specifications based upon a standard 10 bar a transducer

Operating pressure range bar	Overload x F.S.	Accuracy B.S.L. % F.S.	Output with 10 Volt excitation
7	x6	$\pm 0.06\%$	70mV
10	x4(40 bar)	$\pm 0.1\%$	100mV
20	x2	$\pm 0.15\%$	200mV
30	x1.3	$\pm 0.2\%$	300mV

The above example illustrates the various specification performances when using the standard 10 bar core. e.g. used at 20 bar continuously, the overload is x2, accuracy is $\pm 0.15\%$ B.S.L. and output 200mV

10	x4(40 bar)	$\pm 0.06\%$	100mV
----	------------	--------------	-------

The above example can be selected if $\pm 0.06\%$ is required with 100mV output for ranges up to 20 bar.

INSTALLATION DRAWINGS

Dimensions: mm

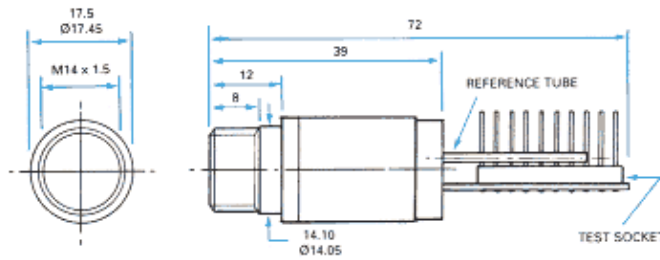

Electrical Connection
Test socket PDCR 80X

k	1	Output negative
f	3	Supply negative
e	4	Supply positive
j	5	Output positive
b	2	Rcal

PDCR 80X

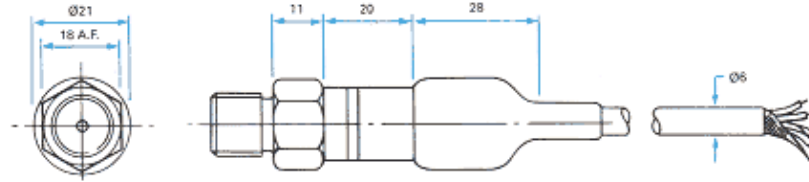

Electrical Connection

- 5 Core shielded/vented cable
 - Red Supply positive
 - White Supply negative
 - Yellow Output positive
 - Blue Output negative
 - Orange Rcal
 - Screen N/C to transducer body
- Any other cores not connected.

PDCR 81X

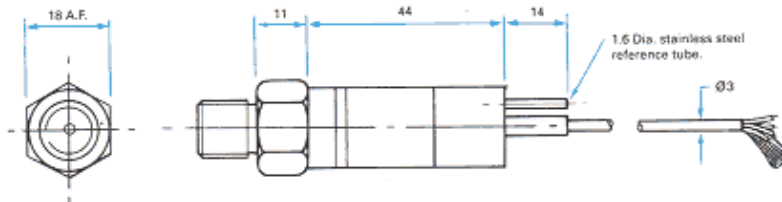

Electrical Connection

- 4 Core p.t.f.e. shielded cable
- Red Supply positive
- Blue Supply negative
- Yellow Output positive
- Green Output negative
- Screen N/C to transducer body

PDCR 82X

Pressure Connection
Illustrated front end depth cone fitted as standard.
This incorporates a hydraulic damper to protect the device from high pressure pulses caused by underwater impact.

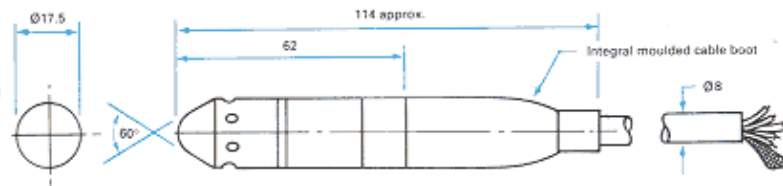

Electrical Connection

- 9 Core shielded/vented cable
 - Red Supply positive
 - White Supply negative
 - Yellow Output positive
 - Blue Output negative
 - Orange Rcal
 - Black To transducer body
 - Screen To transducer body
- Any other cores not connected.

PDCR 83X

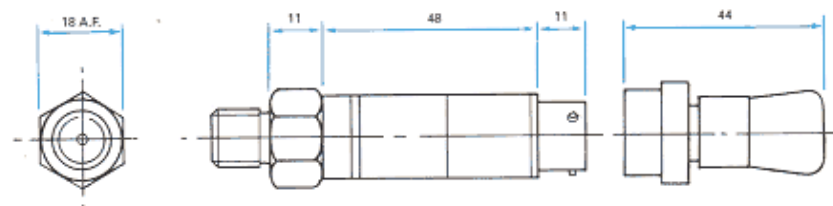

Electrical Connection

- Pin A Supply positive
- Pin B Output positive
- Pin C Output negative
- Pin D Supply negative
- Pin E Rcal

PDCR 86X

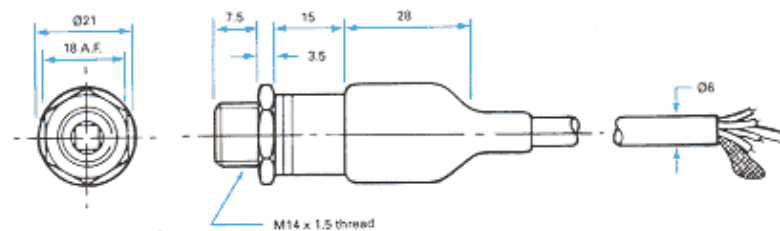

Electrical Connection

- 6 Core shielded/vented cable
 - Red Supply positive
 - White Supply negative
 - Yellow Output positive
 - Blue Output negative
 - Orange Rcal
 - Screen N/C transducer body
- Any other cores not connected.

e.g. PDCR 81X
with flush fitting pressure connection

Druck Limited
Fir Tree Lane, Groby
Leicester LE6 0FH England
Tel: +44 (0) 116 231 7100
Fax: +44(0) 116 231 7103
E-mail: sales@druck.com
Internet: www.druck.com

Agent: