

# PACE5000 / 6000

## Pressure Automated Calibration Equipment Instruction Manual





# Introduction

The PACE5000/6000 are pneumatic pressure controllers. The PACE5000 contains one pressure control module. The PACE6000 can contain up to two independent pressure control modules. The color touch-screen displays the measured pressure and the status of the instrument. The touch-screen enables selections and settings to be changed. The instrument can be operated remotely through communication interfaces.

## Safety



**WARNING** Do not apply pressure greater than the maximum safe working pressure.

The manufacturer has designed this equipment to be safe when operated using the procedures detailed in this manual. Do not use this equipment for any other purpose than that stated, the protection provided by the equipment may be impaired.

This publication contains operating and safety instructions that must be followed to make sure of safe operation and to maintain the equipment in a safe condition. The safety instructions are either warnings or cautions issued to protect the user and the equipment from injury or damage. Use qualified technicians\* and good engineering practice for all procedures in this publication.

## Pressure

Do not apply pressures greater than the maximum working pressure to the equipment.

## Toxic Materials

There are no known toxic materials used in construction of this equipment.

## Maintenance

The equipment must be maintained using the procedures in this publication. Further manufacturer's procedures should be done by an authorized service agents or the manufacturer's service departments.

**Druck.com**





## Technical Advice

For technical advice contact the manufacturer.

---

\* A qualified technician must have the necessary technical knowledge, documentation, special test equipment and tools to carry out the required work on this equipment.

# Symbols

Symbol	Description
	This equipment meets the requirements of all relevant European safety directives. The equipment carries the CE mark.
	This symbol, on the equipment, indicates that the user should read the user manual.
	This symbol, on the instrument, indicates that the user should refer to the user manual. This symbol, in this manual, indicates a hazardous operation. Ce symbole, sur l'instrument, indique que l'utilisateur doit consulter le manuel d'utilisation. Ce symbole, dans le manuel, indique une situation dangereuse.
	This symbol warns the user of the danger of electric shock. Ce symbole alerte l'utilisateur sur le danger de choc électrique.
	Do not dispose of this product as household waste. Use an approved organization that collects and/or recycles waste electrical and electronic equipment. For more information, contact one of these: - Our customer service department: <b>Druck.com</b> - Your local government office.



**WARNING** Turn off the source pressure(s) and carefully vent the pressure lines before disconnecting or connecting the pressure lines. Proceed with care. Only use equipment with the correct pressure rating.

Before applying pressure, examine all fittings and equipment for damage. Replace all damaged fittings and equipment. Do not use any damaged fittings and equipment.

Do not exceed the maximum working pressure of the instrument.

This equipment is not rated for oxygen use.



**RISK OF ELECTRIC SHOCK** The ground lead of the instrument must be connected to the AC supply protective safety ground.

Isolate the power supply before making any electrical connections to the rear panel.



## General Specification

Item	Description
Display	LCD: Color display with touch-screen.
Operating Temperature	10°C to 50°C (50°F to 122°F)
Storage Temperature	-20°C to 70°C (-4°F to 158°F)
Ingress Protection	IP20 (EN 60529)
Operating Humidity	5% to 95% RH (non-condensing)
Vibration	MIL-PRF-28800 Type 2 class 5 style E/F
Operating Altitude	Maximum 2000 metres (6560 ft)
EMC	EN 61326
Electrical Safety	EN 61010-1, UL 61010-1, CSA 22.2, No. 61010-1 and IEC 61010-1
Power Supply	PACE 5000: Input range: 100 - 240 V ac, (50/60 Hz), 2 A, installation category II, Fuse T2AH250V PACE 6000: Input range: 100 - 120/200 - 240 V ac (50/60 Hz), 5A, installation category II, Fuse T5AH250V
Pressure Safety	Pressure Equipment Directive - Class: Sound Engineering Practice (SEP) for group 2 fluids.
Pollution Degree	2
Operating Environment	Indoor use only. Do not use in potentially explosive environments.

## Abbreviations

The following abbreviations are used in this manual. Abbreviations are the same in the singular and plural.

Abbreviation	Description
a	Absolute
ac	Alternating Current
dc	Direct current
DPI	Digital Pressure Instrument
etc.	And so on
e.g.	For example
ft	Foot
g	Gauge
GPiB	General purpose interface bus
H <sub>2</sub> O	Water
Hg	Mercury
Hz	Hertz
IDOS	Intelligent Digital Output Sensor (Druck product)
i.e.	That is

Abbreviation	Description
IEEE 488	Institute of Electrical and Electronic Engineers standard 488 (for programmable devices with a digital interface)
in	Inch
kg	kilogram
m	Metre
mA	milliampere
max	Maximum
mbar	millibar
min	Minute or minimum
MSDS	Material safety data sheet
MWP	Maximum working pressure
NPT	National Pipe Thread
Pa	Pascal
PACE	Pressure Automated Calibration Equipment
psi	Pounds per square inch
REF	Reference
RS-232	Serial communications standard
Rx	Receive data
SCPI	Standard Commands for Programmable Instruments
SELV	Separated (or Safety) Extra Low Voltage
Tx	Transmit data
UUT	Unit Under Test
V	Volts
°C	Degrees Celsius
°F	Degrees Fahrenheit

## Associated Publications

The following table lists the Druck publications referenced in this manual:

Publication	Title
K0447	PACE 5000/6000 User Guide and Safety Instructions
K0476	Pressure Control Module User Guide and Safety Instructions
K0469	PACE Heritage Communications Manual
K0450	PACE Series Calibration Manual
K0472	PACE Series SCPI Manual

# Contents

1.	Description	1
1.1	Introduction	1
2.	Installation	3
2.1	Packaging	3
2.2	Packaging for Storage or Transportation	3
2.3	Preparation for Use	3
2.4	Connecting to PACE	3
2.4.1	Pressure Adaptors	4
2.4.2	Pressure Connection	5
2.5	Connecting to UUT	6
2.6	System	6
2.7	Supply Equipment	7
2.7.1	Pneumatic Connection Examples	8
2.8	Rack-mount Option	10
2.9	Power Connection	12
2.9.1	Pressure Control Module DC Power and Logic Input Connectors	12
2.10	Communication Connection	13
2.10.1	RS-232 Interface	13
2.10.2	IEEE 488 Interface	14
3.	Operation	17
3.1	Preparation	17
3.2	Power-up Sequence	17
3.3	Measure Mode	19
3.3.1	Auto-Range	20
3.3.2	Controller Off – Increasing Set-point	20
3.3.3	Controller Off – Decreasing Set-point	21
3.3.4	Controller On – Increasing Set-point	21
3.3.5	Controller On – Decreasing Set-point	21
3.4	Control Mode	21
3.4.1	Controlling to a New Set-point	22
3.4.2	Effort Meter	23
3.4.3	Controlling to Ambient/Zero Pressure	23
3.5	Operation and Example Procedures	24
3.5.1	Introduction	24
3.5.2	Measure and Control Modes	24
3.5.3	Task	25
3.5.4	Divider	26
3.5.5	Divider Menu Structure	26
3.5.6	Preset	27
3.6	Global Setup Selections	28
3.6.1	Status Area Settings	29
3.7	Barometric Reference Option	30
3.8	Supervisor Setup	31
3.9	Instrument Status	32
3.9.1	Software	33

4.	<b>Maintenance</b>	<b>35</b>
4.1	Introduction	35
4.2	Visual Inspection	35
4.3	Cleaning	35
4.4	Test	35
4.5	Software Update	35
4.6	Replacement Parts	37
4.6.1	Fuse Replacement	37
4.6.2	Pressure Control Module Filters	38
4.6.3	Pressure Control Module Replacement	39
5.	<b>Testing and Fault Finding</b>	<b>41</b>
5.1	Introduction	41
5.2	Standard Serviceability Test	41
5.3	Fault Finding	42
5.4	Approved Service Agents	42
6.	<b>Reference</b>	<b>43</b>
6.1	Installation Notes	43
6.1.1	Gas Supply	43
6.1.2	Supply Conditioning Equipment	43
6.1.3	Maximum Working Pressure	43
6.1.4	Supply Contamination	43
6.1.5	Systems without a Negative Supply	44
6.1.6	General	44
6.1.7	Operating Near Atmospheric Pressure or Below	44
6.1.8	Vacuum Pump	44
6.2	Operational Requirements	44
6.2.1	Negative or Vacuum Supply	44
6.2.2	Oil Contamination	45
6.2.3	Pump Performance	45
6.2.4	Venting	45
6.2.5	Vent	45
6.2.6	Zero	45
6.2.7	Output Port	45
6.2.8	Reference Port	45
6.3	Measure Setup	46
6.3.1	Pressure Zero	46
6.3.2	Process	46
6.3.3	Task	46
6.3.4	Units	46
6.3.5	Global Setup	46
6.3.6	Setup Zero	46
6.4	Control Setup	47
6.4.1	Vent	47
6.4.2	Nudge	47
6.4.3	Set-point Limits	47
6.4.4	Slew Rate	47
6.4.5	Control Mode	47
6.4.6	Active Control	47
6.4.7	Passive Control	47

6.4.8	Zero Gauge Control	47
6.5	Global Setup	47
6.6	Status	48
6.7	Vent Setup	48
6.8	Global Setup	48
6.8.1	Supervisor Setup	48
6.8.2	Calibration	48
6.8.3	Save/Recall user setup.	48
6.8.4	Display	48
6.9	Supervisor Setup	49
6.9.1	Protective Vent	49
6.9.2	In-Limits	49
6.9.3	Alarms	49
6.9.4	Communications	49
6.9.5	Timeout	56
6.9.6	Idle Timeout	56
6.9.7	Gas Head Correction	56
6.9.8	Lock Tasks	56
6.9.9	Change PIN	56
6.9.10	User Defined Units	56
6.9.11	Instrument Alias Name	57
6.9.12	Language	57
6.9.13	Restore as Shipped Settings	58
6.10	Option Enable Process	58
6.11	Leak Test Option	59
6.12	Switch Test Option	61
6.12.1	Start	61
6.12.2	Test	62
6.12.3	End	62
6.12.4	Procedure	62
6.13	Test Program Option	62
6.13.1	Creating a Test Program	63
6.13.2	Editing an Existing Test Program	63
6.13.3	Running a Test Program	63
6.13.4	Copying a Test Program	63
6.13.5	Example Program	65
6.13.6	Programming Loops	66
6.14	Barometric Reference Option	67
6.14.1	Zeroing the Reference Sensor	69
6.15	Aeronautical Option	71
6.15.1	Leak Testing	71
6.15.2	Aeronautical Testing	71
6.15.3	Example of Altitude and Airspeed Testing	72
6.15.4	Units	72
6.15.5	Reference Pressure	73
6.15.6	Go to Ground	73
6.15.7	Control of Aeronautical Parameters	74
6.16	Analog Output Option	76
6.17	Volts-free Contact Option	77
6.18	Burst Pressure Testing Option	77
6.18.1	Selecting Burst Pressure Task	78
6.18.2	Test Parameter Entry	78
6.18.3	Example Burst Pressure Test	80

6.19	Calibration	80
6.20	Communications - Instrument Emulation	81
6.21	Specification	81
6.22	Return Goods/Material Procedure	81
	6.22.1 Safety Precautions	81
6.23	Packaging Procedure	81
6.24	Vacuum System Parts	82
Appendix A. Pressure Units and Conversion Factors		83
Appendix B. Air Density		85
Appendix C. User Interface Icons		87

# 1. Description

## 1.1 Introduction

The PACE5000 single-channel and PACE6000 single/dual-channel, Pressure Automated Calibration Equipment measures and controls pneumatic pressures and displays, on a touch-screen, the pressure measurement and controller status. The touch-screen enables selections and settings in both measure and control modes. The instrument can be operated remotely through communication interfaces.



**Figure 1-1: PACE5000 General View**



**Figure 1-2: PACE6000 General View**

The rear of the instrument houses all the electrical and pneumatic output and input connections. The electrical connections provide an AC power supply, serial and parallel communication interfaces, DC output and Logic input and output. The system pneumatic controller module contains a positive and negative pressure supply port, an output port, vent port and reference port.

The instrument can be used as follows:

- Free-standing instrument positioned on a horizontal surface.
- Rack-mounted in a standard 19 inch rack using the rack-mount option kit.

# Chapter 1. Description

---



**Figure 1-3: PACE5000 Rear View**

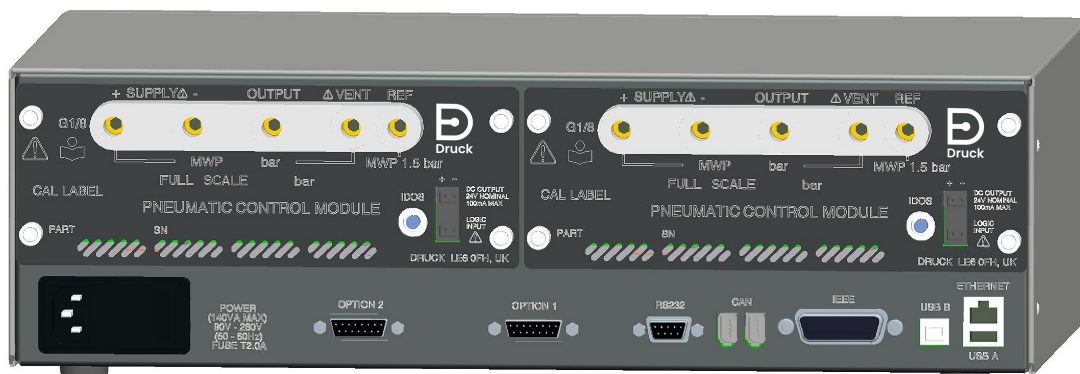

**Figure 1-4: PACE6000 Rear View**

Options available are detailed in the product Data Sheet.

For information and notes on applications, refer to Section 6, “Reference,” on page 43 or [Druck.com](http://Druck.com).



## 2. Installation

### 2.1 Packaging



**INFORMATION** After unpacking a cold instrument, allow time for it to stabilize and any condensation to evaporate.

Check that the PACE5000/6000 packaging contains the following:

1. PACE5000 or PACE6000 Pressure Controller.
2. Power supply cable.
3. Safety instructions, instruction manual and CD-ROM containing the full documentation suite.
4. Pressure Control Module blanking plate. Keep this plate for future use.

### 2.2 Packaging for Storage or Transportation



**INFORMATION** After removing a pressure control module, fit a blanking plate to the PACE chassis to protect the unit and to keep the flow of cooling air.

To store or return the instrument for calibration/repair:

1. Pack the instrument. Refer to Section 6.23, "Packaging Procedure," on page 81.
2. Return the instrument for calibration/repair complete the return goods procedure. Refer to Section 6.22, "Return Goods/Material Procedure," on page 81.

**Note:** The procedure above applies to the pressure control module as a separate item.

### 2.3 Preparation for Use

The instrument can be positioned in the following ways:

- Free-standing instrument positioned on a horizontal surface.
- Rack-mounted in a standard 19 inch rack using the rack-mount option kit. Refer to Section 2.8, "Rack-mount Option," on page 10.

For free-standing instruments, the feet on the front of the base can be used elevate the instrument to a better viewing angle.

**Note:** Do not obstruct the air cooling outlet on the underside of the instrument. Allow a free flow of air around the instrument, especially at high ambient temperatures.

### 2.4 Connecting to PACE



**WARNING** Turn off the source pressure(s) and carefully vent the pressure lines before disconnecting or connecting the pressure lines. Proceed with care.

Only use equipment with the correct pressure rating.

Before applying pressure, examine all fittings and equipment for damage. Replace all damaged fittings and equipment. Do not use any damaged fittings and equipment.

Do not exceed the maximum working pressure of the instrument.

This equipment is not rated for oxygen use.

## Chapter 2. Installation

### 2.4.1 Pressure Adaptors

Figure 2-1 shows the available range of PACE pressure adaptors.

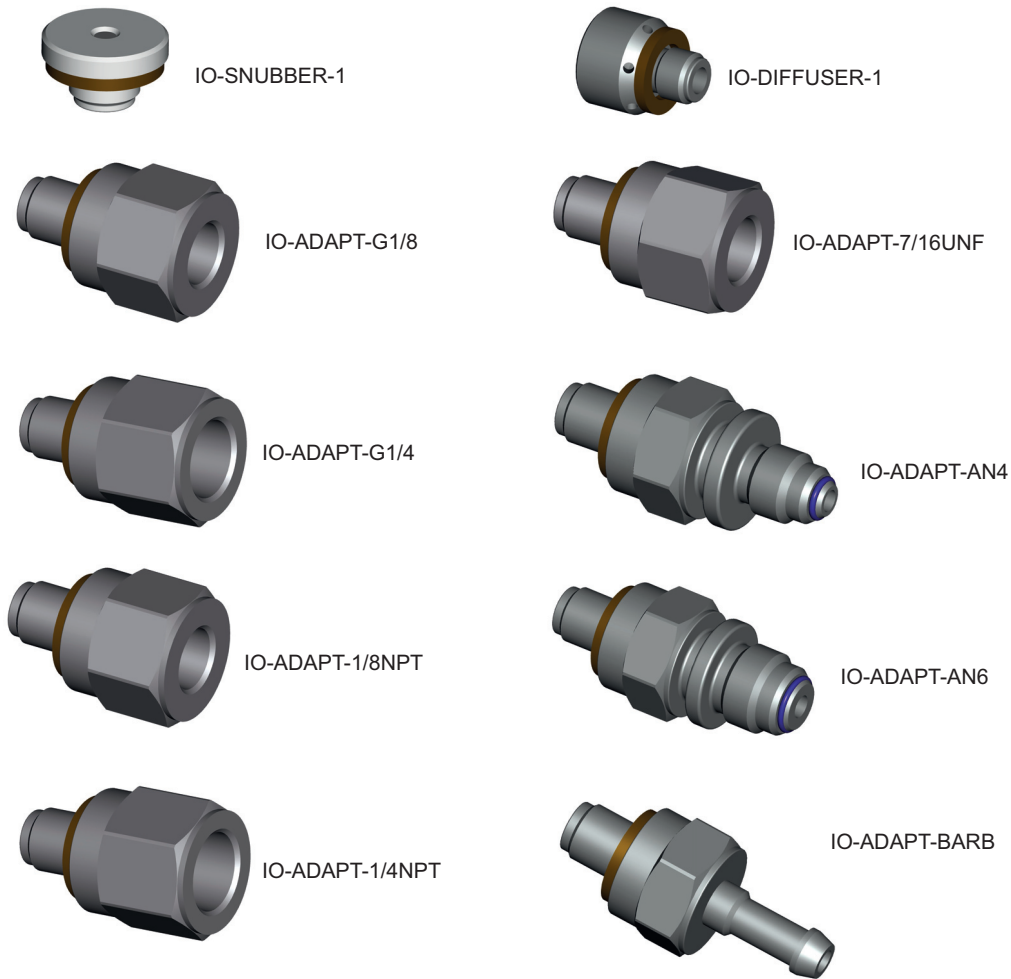

**Figure 2-1: Pressure Adaptors**

Refer to Table 2-1 and the Data Sheet for more information.

**Table 2-1: Pressure Adaptor Specification**

Adaptor Part Number	Specification
IO-SNUBBER-1	Restrictor/Snubber
IO-DIFFUSER-1	Diffuser
IO-ADAPT-1/4NPT	ISO 228 G1/8 Male to 1/4 NPT Female.
IO-ADAPT-1/8NPT	ISO 228 G1/8 Male to 1/8 NPT Female.
IO-ADAPT-7/16UNF	ISO 228 G1/8 Male to 7/16-20 UNF Female.
IO-ADAPT-AN4	ISO 228 G1/8 Male to AN4 37° Male.
IO-ADAPT-AN6	ISO 228 G1/8 Male to AN6 37° Male.
IO-ADAPT-BARB	ISO 228 G1/8 Male to 1/4 Hose.
IO-ADAPT-G1/4	ISO 228 G1/8 Male to ISO 228 G1/4 Female.
IO-ADAPT-G1/8	ISO 228 G1/8 Male to ISO 228 G1/8 Female.

2.4.2 Pressure Connection



**WARNING** Parallel threads must be used. Female thread type is parallel thread to ISO228/1 (DIN ISO228/1, JIS B0202) G1/8.

Tapered threads not allowed.

The PACE has parallel thread pressure connectors. Use only the connector type specified in Table 2-2.

**Table 2-2: PACE Pressure Connector Thread Specification**

PACE Connector	Thread Specification
Supply +, Supply -, Output, Vent, Reference	ISO228/1 G1/8 Parallel Threads (DIN ISO228/1, JIS B0202)

Refer to Figure 2-2 for connection to the PACE pressure connectors.

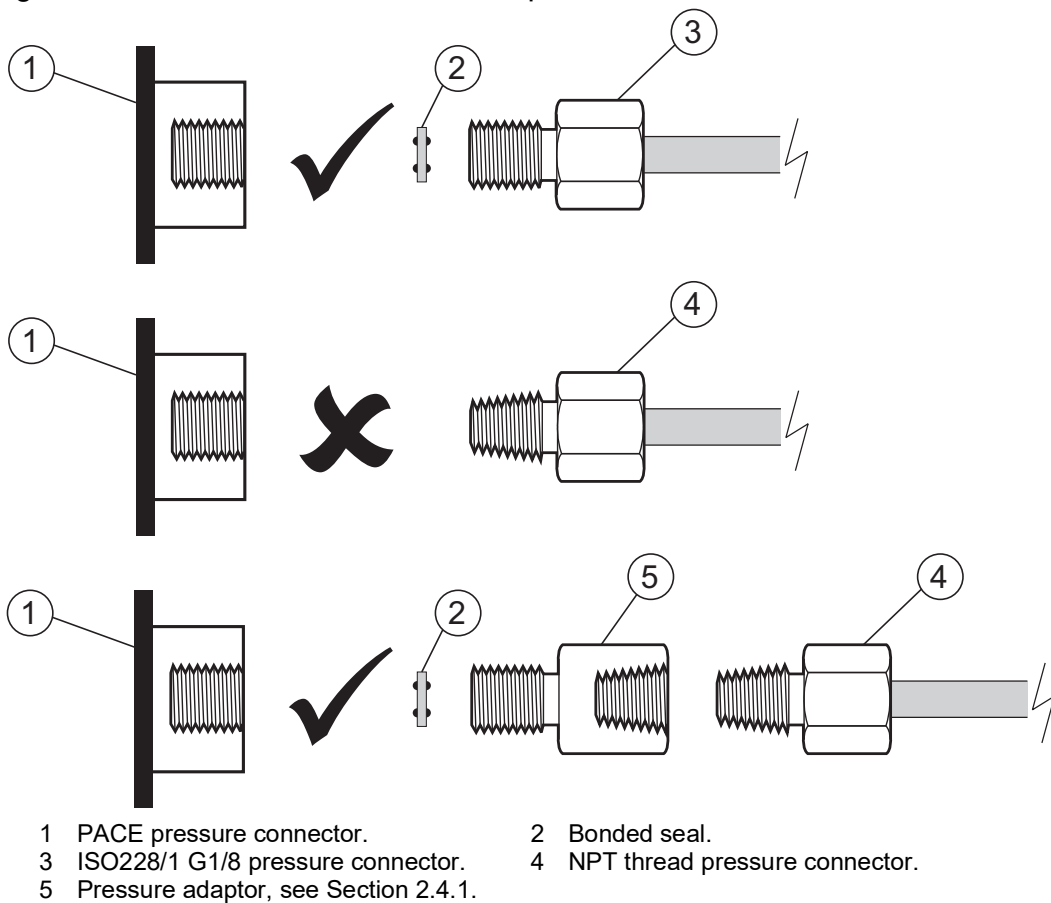

**Figure 2-2: PACE Pressure Connection**

## Chapter 2. Installation

For pressures less than 100 bar (1450 psi), see alternative sealing method in Figure 2-3.

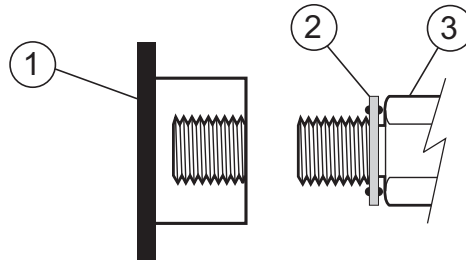

- 1 PACE pressure connector.
- 2 Bonded seal.
- 3 ISO228/1 G1/8 pressure connector or adaptor. For adaptors, see Section 2.4.1.

**Figure 2-3: Alternative Sealing Method for < 100 bar (1450 psi)**

### 2.5 Connecting to UUT



**CAUTION** Do not exceed the maximum pressures stated in the appropriate component manual for the unit under test.

**Reduce pressure at a controlled rate when venting to atmosphere.**

**Carefully de-pressurize all pipes (tubes) to atmospheric pressure before disconnecting and connecting to the unit under test.**

The pressure should not exceed 1.25 x full-scale or MWP stated on the rear panel of the instrument.

To protect the instrument from over-pressure, fit a suitable protection device such as a relief valve or bursting disc.

1. Switch off the power supply before connecting or disconnecting the instrument.
2. Use the appropriate sealing method for all pressure connections. Refer to Section 2.4.2 on page 5.
3. Isolate the pneumatic pressures and de-pressurize the pipes (tubes) before connecting or disconnecting the instrument.
4. Make sure the user systems can be isolated and vented.
5. The pneumatic gas must be clean and dry, nitrogen or air. Refer to specification in the Data Sheet.
6. Connect pressure and vacuum supplies to the SUPPLY + and SUPPLY - connection ports.
7. Connect the Unit Under Test (UUT) to the appropriate connection port.

### 2.6 System

The safety of any system incorporating the equipment is the responsibility of the assembler of the system.

The instrument requires a positive pressure supply. Instruments operating in an absolute range or negative pressure range require a vacuum supply.

A vacuum supply should be used for a fast response for instruments operating near atmospheric pressure.

For dual channel operation, two independent pressure and vacuum supplies can be used

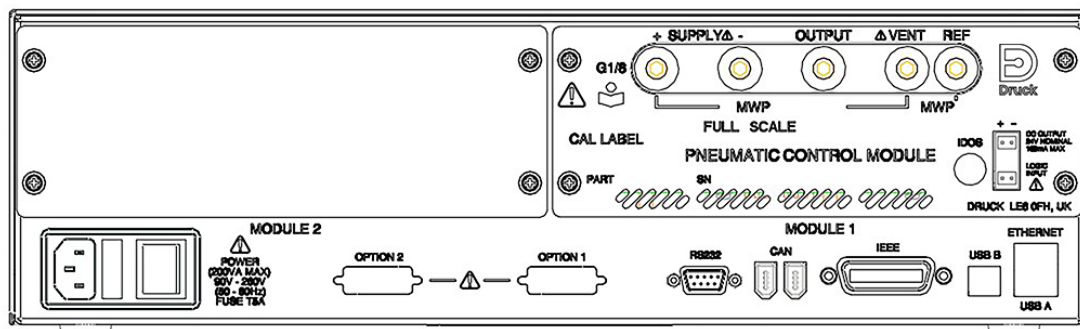

**Figure 2-4: Control Module Rear View**

When using two pressure control modules:

- The control module with the highest pressure rating is fitted to the right hand side. This is labeled as Module 1 as viewed from the rear of the product. Refer to Figure 2-4.
- If two control modules have the same pressure rating, the control module with the higher serial number is fitted to the right hand side. This is labeled as Module 1 as viewed from the rear of the product. Refer to Figure 2-4.

All pneumatic connections must comply with the Pressure Equipment Directive (PED) or equivalent regional pressure standard.

When connecting the output ports of two pressure control modules together make sure both are either:

- $\leq 70$  bar (1000 psi)  
OR
- between 100 to 210 bar (1450 to 3000 psi).

To prevent over-pressurization of pneumatic parts and maintain compliance with the PED, do not connect the output of modules with range of 70 bar (1000 psi) and below to modules with range above 70 bar (1000 psi), e.g. 100 bar (1450 psi) and 210 bar (3000 psi) modules.

## 2.7 Supply Equipment

Pneumatic supplies should have isolation valves and, where necessary, conditioning equipment.

The positive pressure supply should be regulated to between 110% of the full-scale pressure range and MWP stated on the control module.

To protect the instrument from over-pressure a suitable protection device (such as a relief valve or bursting disc) must be fitted to prevent over pressurization.

On instruments without a negative supply, the positive pressure discharges from the system to atmosphere through the negative supply port. Pipe the negative port to a safe discharge area, or fit a diffuser to the negative port.

During system pressure vent operations, the pressure discharges from the system to atmosphere through the negative and vent ports. Pipe both ports to a safe discharge area or fit a diffuser to the negative port.

# Chapter 2. Installation

## 2.7.1 Pneumatic Connection Examples

The following notes apply to the connection examples:

Note	Description
*	High pressure gas exhaust - depending on pressure range.
**	Optional vacuum system kit, allows the -ve port gas to be directly discharged to atmosphere, by-passing the vacuum pump.
†	Optimum controller transient response and minimum time to set-point may be degraded if either the pneumatic supply or vacuum system has restricted flow. Installing a reservoir volume, which has a larger capacity than the load volume, located in close proximity to the controller supply ports can improve the controller response.
‡	Optional negative gauge pressure generator kit.
★	For ranges of 70 bar (1000 psi) and above, fit a suitable protection device to prevent overpressure. For example, fit a relief valve or bursting disc. The protection device must limit the applied pressure to below the MWP.
◇	Optional differential connection kit.

### 2.7.1.1 Pneumatic Connections without Vacuum Supply

The examples below show a single channel connection detail, using supply equipment described above.

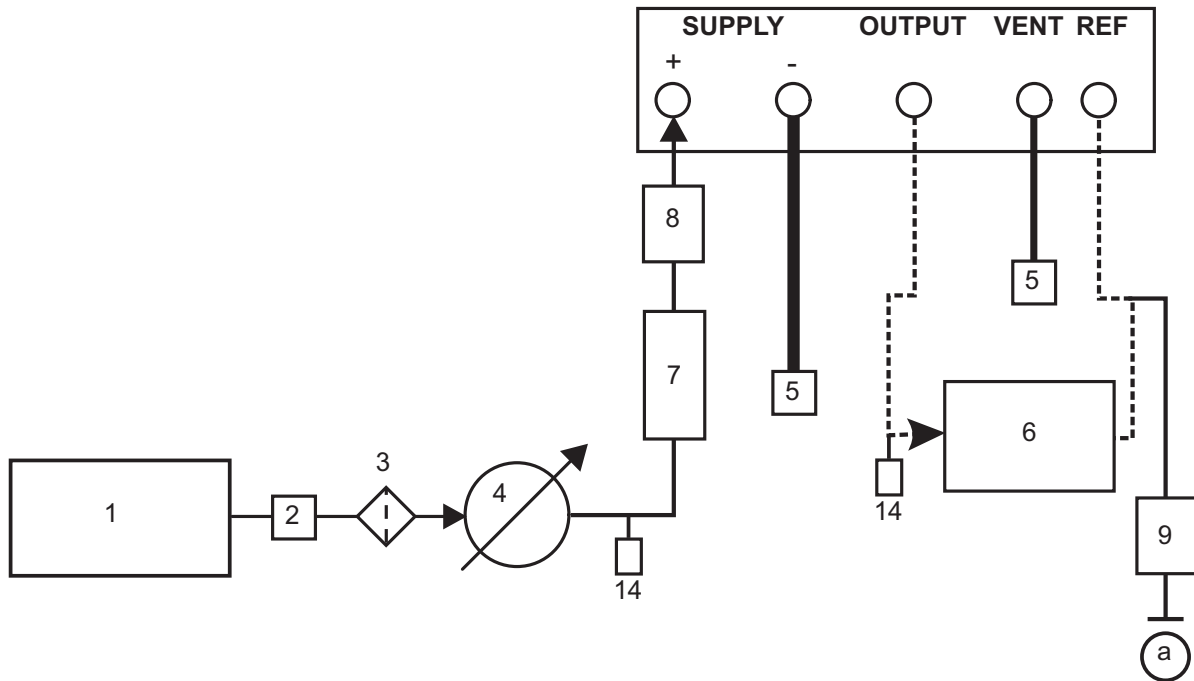

- |   |                                    |    |   |
|---|------------------------------------|----|---|
| 1 | Pressure source                    | 2  | Conditioner                                 |
| 3 | Filter                             | 4  | Regulate to between 110% full-scale and MWP |
| 5 | Diffuser *                         | 6  | Unit under test                             |
| 7 | Optional reservoir †               | 8  | Protection device ★                         |
| 9 | Optional differential connection ◇ | 14 | Manual external vent valves                 |
| a | Atmosphere                         |    |   |

**Figure 2-5: Pneumatic Connections without Vacuum Supply**

**Note:** Refer to Section 6, “Reference,” on page 43 for details of other system components.

## 2.7.1.2 Pneumatic Connections with Vacuum Supply

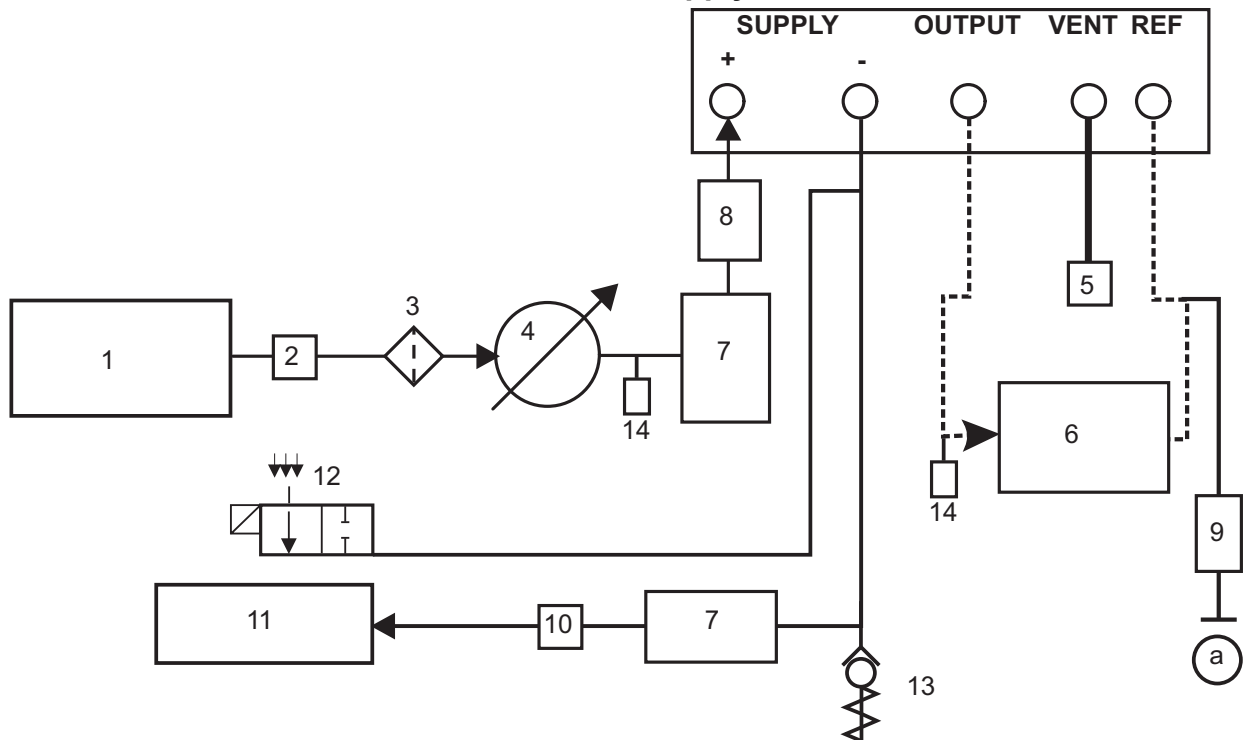

- |    |                                    |    |   |
|----|------------------------------------|----|---|
| 1  | Pressure source                    | 2  | Conditioner                                 |
| 3  | Filter                             | 4  | Regulate to between 110% full-scale and MWP |
| 5  | Diffuser *                         | 6  | Unit under test                             |
| 7  | Optional reservoir †               | 8  | Protection device ★                         |
| 9  | Optional differential connection ◇ | 10 | Oil mist trap                               |
| 11 | Vacuum source                      | 12 | Normally open electrical release valve      |
| 13 | Check valve **                     | 14 | Manual external vent valves                 |
| a  | Atmosphere                         |    |   |

**Figure 2-6: Pneumatic Connections with Vacuum Supply**

**Note:** PACE option IO-VAC-SYS Vacuum System Check Valve Kit should be used in the vacuum line. Mount near to the PACE CM -ve port to exhaust most of the high pressure gas directly to atmosphere. The vacuum buffer volume needs to be rated to at least the highest system pressure.

**Note:** Section 6, "Reference," on page 43 for details of other system components.

2.7.1.3 Pneumatic Connections with Negative Gauge Pressure Generator

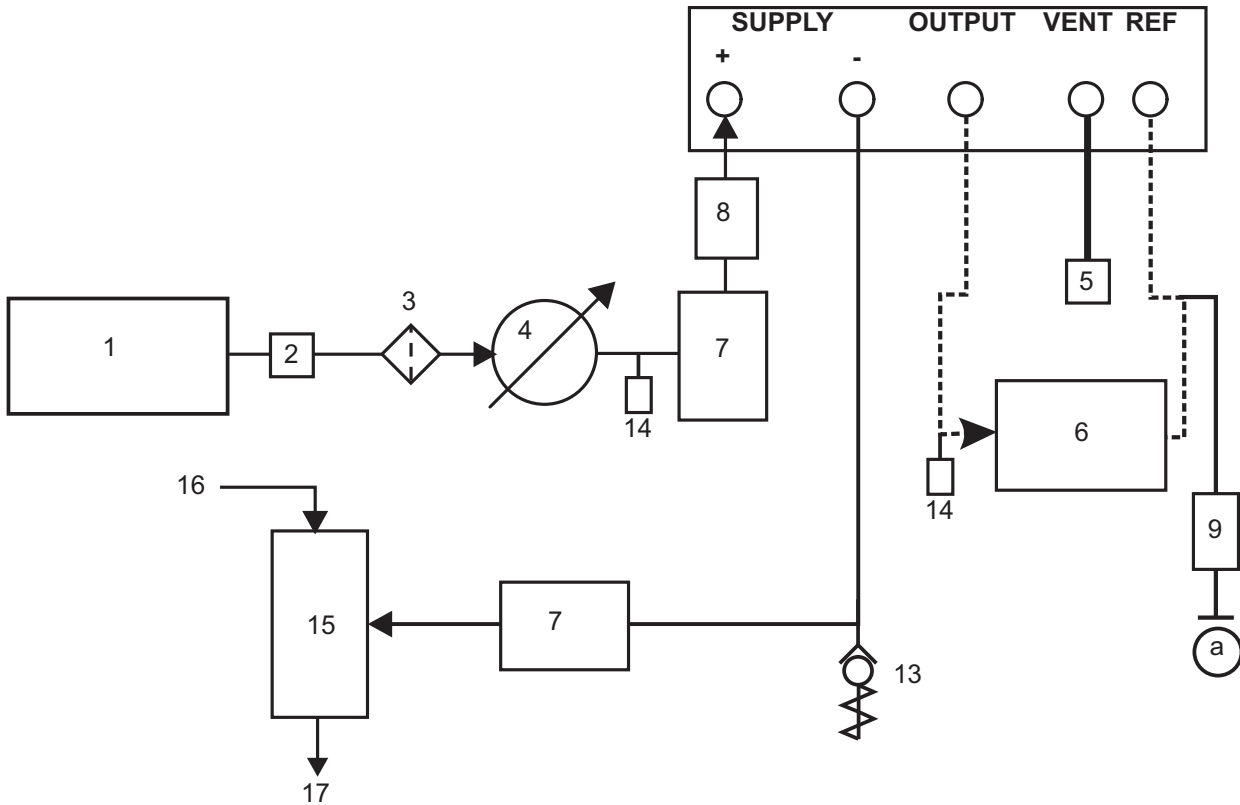

- |    |   |    |   |
|----|---|----|---|
| 1  | Pressure source                                   | 2  | Conditioner                                 |
| 3  | Filter  | 4  | Regulate to between 110% full-scale and MWP |
| 5  | Diffuser *  | 6  | Unit under test                             |
| 7  | Optional reservoir †                              | 8  | Protection device ★                         |
| 9  | Optional differential connection ◇                | 10 | Vacuum generator ‡                          |
| 11 | Source pressure (regulated compressed air supply) | 12 | Exhaust to atmosphere                       |
| 13 | Check valve **                                    | 14 | Manual external vent valves                 |
| a  | Atmosphere  |    |   |

Figure 2-7: Pneumatic Connections with Negative Gauge Pressure Generator

Note: Section 6, “Reference,” on page 43 for details of other system components.

2.8 Rack-mount Option

There must be enough space at the rear of the instrument for all the cables and pipes (tubes). The length of the cables and pipes (tubes) must allow for the removal and installation of the



instrument. The cooling air of the instrument must not be obstructed. Allow a free flow of air through the equipment rack and around the instrument, especially at high ambient temperatures.



**Figure 2-8: Rack-mounting**

1. Locate bracket in rack assembly (1).
2. Remove the four M3x10mm countersunk screws from each of the instrument side panels.
3. Locate the two brackets (2) on each side of the instrument.
4. Secure with the four countersunk screws.
5. Support the instrument and connect the cables and pipes (tubes).
6. Refer to the electrical connections below before fitting the instrument into the rack.
7. Temporarily locate the two spigots\* to each side of the equipment rack.
8. Locate and slide the instrument into the rack.
9. Locate the instrument on the spigots\*.
10. Secure the instrument in the equipment rack with two of the screws and washers (supplied).
11. Remove the two spigots\* and replace with the remaining two screws and washers (supplied).

## 2.9 Power Connection



**RISK OF ELECTRIC SHOCK** The ground lead of the instrument must be connected to the AC supply protective safety ground.

Isolate the power supply before making any electrical connections to the rear panel.

1. Install an accessible power isolator to use as the disconnecting device in the power supply circuit.
2. For power supply range, power rating and installation category, refer to “General Specification” on page iii.

**Note:** The power must be protected by a fused or overload-protection device.

3. Connect the power supply to the instrument.
4. Switch the power supply on.
5. Check that the front panel display shows the power-up sequence. Refer to Section 3.2, “Power-up Sequence,” on page 17.

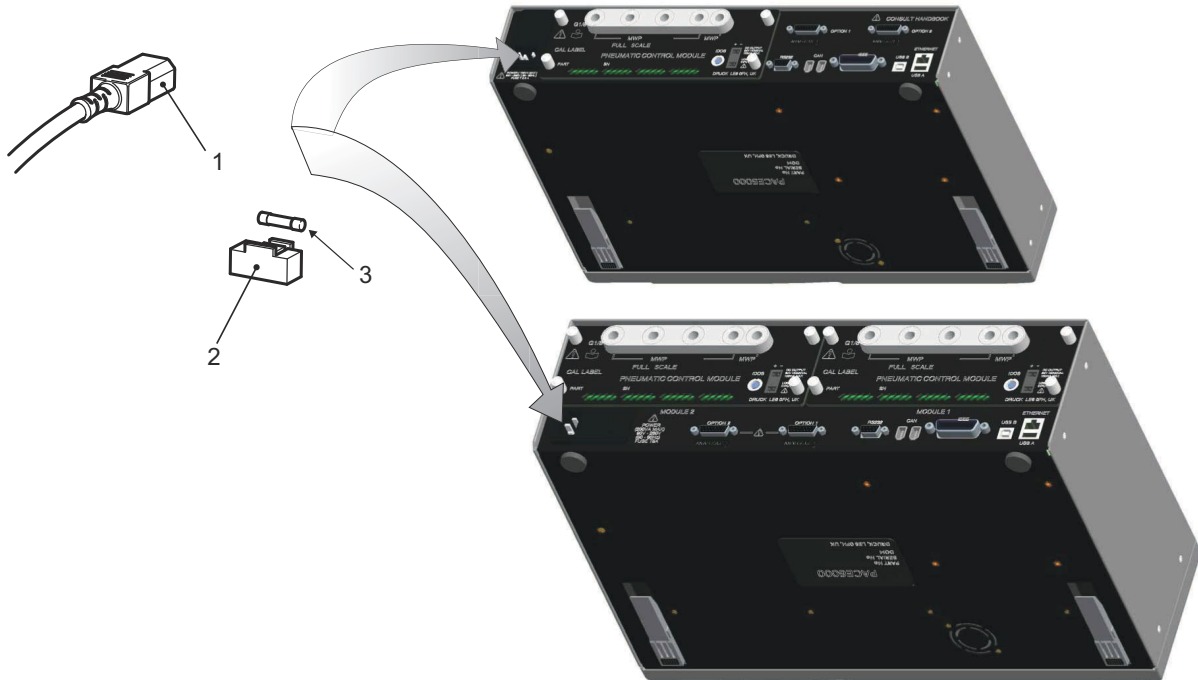

- 1 IEC connector
- 3 Fuse

- 2 Fuse carrier

**Figure 2-9: Electrical Connections**

### 2.9.1 Pressure Control Module DC Power and Logic Input Connectors

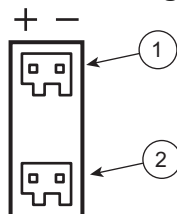

- 1 DC power output

- 2 Logic (Switch) input

The DC power output is rated at 24 V DC, 100 mA. An internal self-resetting fuse protects the output.

This Logic (Switch) input can be used to trigger the instrument from a pressure switch contact during the Pressure Switch Task. Refer to Section 3.4, “Control Mode,” on page 21.

Connections are not polarized and can be connected either way. An internal opto-isolator protects the input.

The Logic (Switch) input can be energized by external SELV compliant equipment.

## 2.10 Communication Connection

Connect the applicable connectors into the rear panel communications ports. If appropriate, secure with the captive screws.

**Note:** The RS-232 and IEEE 488 interfaces are both enabled at power-up. Set the required parameters in Supervisor Setup/communications menu. Refer to Section 3.8, “Supervisor Setup,” on page 31.

**Note:** Refer to the Data Sheet for a list of optional communication ports.

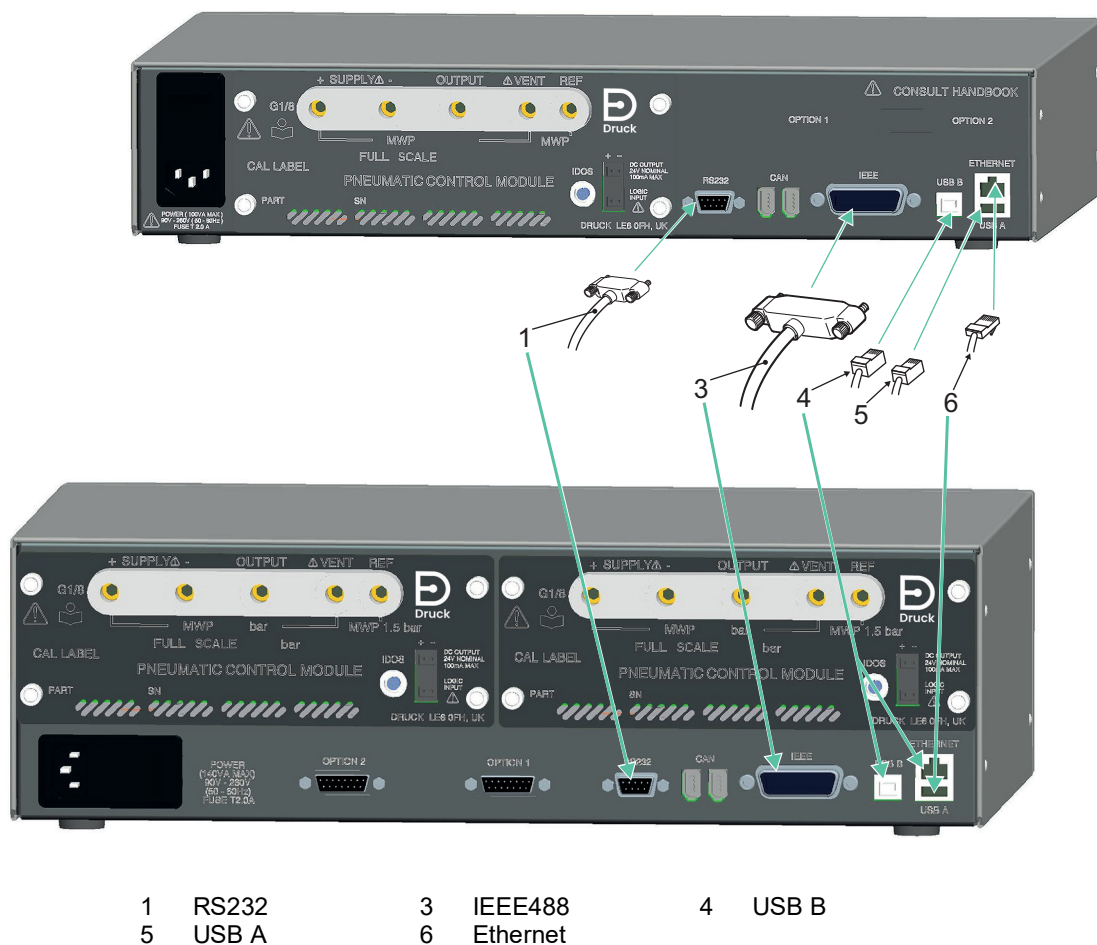

**Figure 2-10: Communication Connectors**

### 2.10.1 RS-232 Interface

When using the RS-232 interface, a cable must be connected directly from the instrument to a suitable port on the computer in a ‘point to point’ link.

## Chapter 2. Installation

The pin connections for the 9-pin D-type, RS-232 connector and the relationship between the instrument and the RS-232 control signals, together with device interconnection interface is shown in Table 2-3. The instrument is configured as Data Circuit Terminating Equipment (DCE).

**Table 2-3: RS-232 Connections**

Instrument		Control Line		Computer	
Instrument Function	9-way D-type Pin No.	Signal Direction	RS-232 Terminology	9-way D-type Pin No.	25-way D-type Pin No.
RxD (I/P)	3	←	TxD	3	2
TxD (O/P)	2	→	RxD	2	3
GND	5	↔	GND	5	7
CTS (I/P)	7	←	RTS	7	4
RTS (O/P)	8	→	CTS	8	5
Pulled high internally	1	→	RLSD (DCD)	1	8
Not connected	4	←	DTR	4	20
Pulled high internally	6	↔	DSR DCE Ready	6	6
Equipment chassis	Connector shell	↔	Cable Screen	-	1

**Note:** For software handshaking use: TXD, RXD and GND. For hardware handshaking use: TXD, RXD, GND, CTS, RTS and DTR.

### 2.10.2 IEEE 488 Interface

The interface complies with IEEE 488 standard.

The IEEE 488 parallel interface connects a computer/controller to one or more PACE1000 instruments and other instruments.

Up to 30 instruments can be connected through a high-speed data bus to the computer/controller.

**Note:** The length of each IEEE 488 cable must be less than 3 metres to comply with the EMC requirements. Refer to Data Sheet.

#### 2.10.2.1 Single Unit Installation

1. Connect an IEEE 488 connector/cable assembly to the rear panel of the instrument.
2. Connect the other end of the connector/cable assembly to the IEEE 488 connector on the controller/computer.
3. Change the IEEE 488 communication parameters. Refer to Section 6.9.4.2, "IEEE 488," on page 50.

### 2.10.2.2 Multiple Unit Installation

To install multiple units use stacking plugs to link the first instrument and second instrument as follows:

1. Connector to rear panel of first instrument. Refer to illustration.
2. Connector from controller/computer. Refer to illustration.
3. Connector to rear panel of second instrument. Refer to illustration.
4. Connect the IEEE 488 connector on the controller/computer and the other connector into the next instrument.
5. Repeat this procedure for all the instruments in the system.
6. Use the Supervisor setup (communications) menu on each instrument to setup the required communication parameters. Refer to Section 6.9.4.2, "IEEE 488," on page 50.

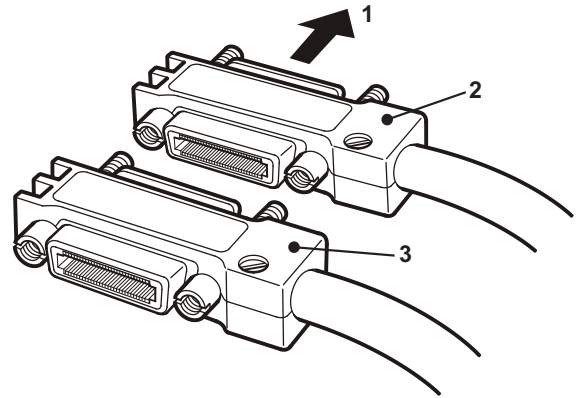

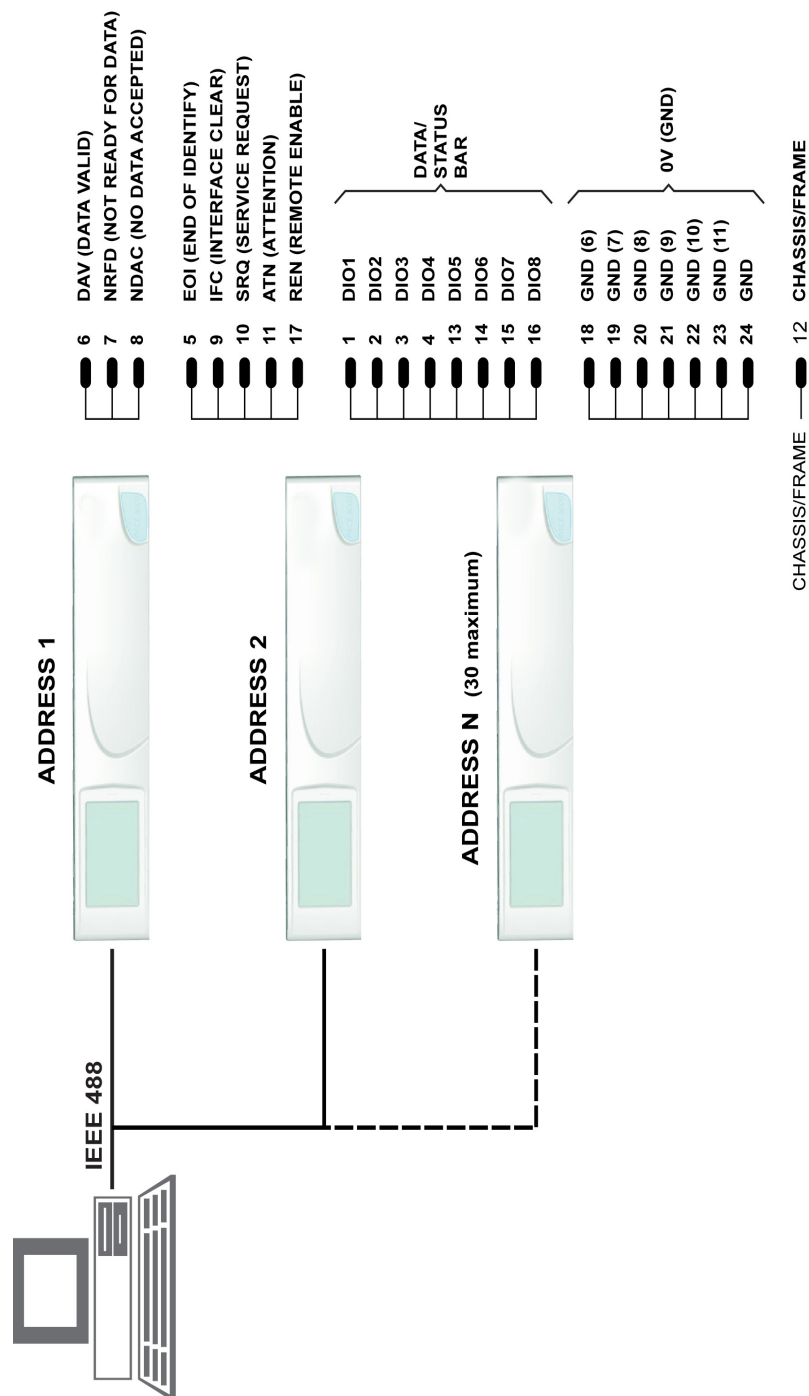

**Figure 2-11: IEEE 488 Connection**

## 3. Operation

This section contains quick reference charts detailing all the available functions and the setup menu.

### 3.1 Preparation

Make sure the electrical cables and pneumatic pipes (tubes) comply with the installation requirements. Refer to Section 2, "Installation," on page 3.

Before use do the following:

1. If necessary, do the maintenance task. Refer to Section 4, "Maintenance," on page 35.
2. For bench-top, single instrument operation do the following:
  - a. Connect the instrument to the electrical supply.
  - b. Inspect the pneumatic hoses for damage, ingress of dirt and moisture.
3. Before use, the instrument should be tested.
4. Review and become familiar with the procedure before starting a process on a component or system.

**Note:** The touch-screen can be permanently damaged by sharp objects.

### 3.2 Power-up Sequence

The following sequences of operation shows the instrument display.

**Note:** The following sequence is an example, the values and selections displayed depend on the range(s) and options enabled in the instrument.

1. Set the power supply to ON:
2. The display shows the power-up sequence.
 

**Note:** Do not touch the display screen during power-up.
3. The instrument carries out a self-test.
 

**Note:** If the test finds a fault, the display shows an error. Refer to Section 5.3, "Fault Finding," on page 42.
4. If the self-test is successful the system enables the touch screen and changes to measure mode.
5. The touch screen shows the measured pressure in the parameters selected in setup.
6. The instrument is now ready for use.

**Note:** PACE 6000 shows a single display by default. This is the left hand pressure control module. Change to dual display in Global Setup/Display menu.

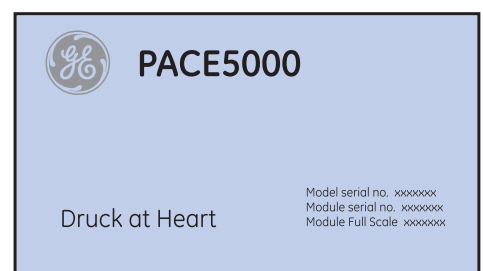
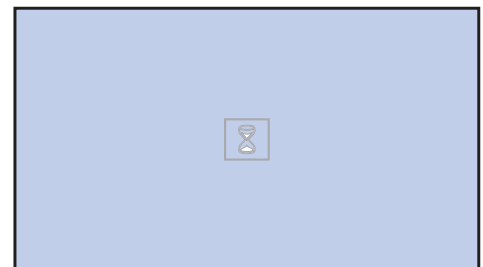

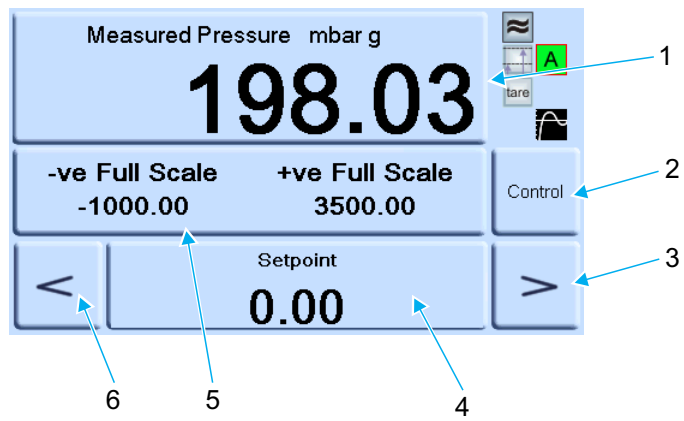

- |   |                                       |   |                           |
|---|---------------------------------------|---|---------------------------|
| 1 | Measure setup                         | 2 | Control/measure selection |
| 3 | Nudge up                              | 4 | Set-point entry           |
| 5 | Status (touch to enter control setup) | 6 | Nudge down                |

**Figure 3-1: Touch Screen Areas**



### 3.3 Measure Mode

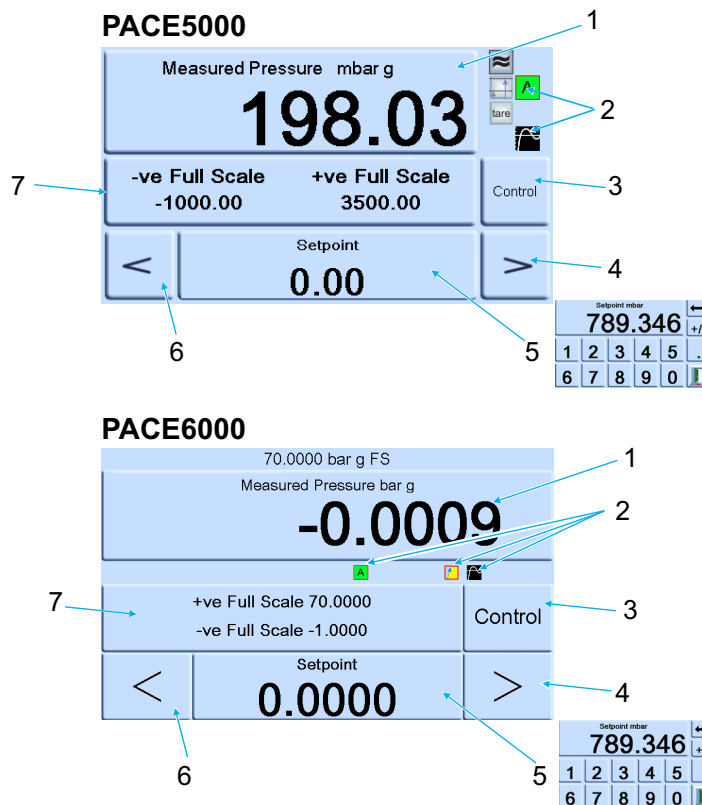

- 1 Pressure measurement of current selected sensor in current selected pressure measurement units.
- 2 Current enabled functions.
- 3 Control/measure selection
- 4 Nudge up, changed in control setup.
- 5 Current set-point value, change with numeric keys.
- 6 Nudge down, changed in control setup.
- 7 Status area, changed in global setup

Figure 3-2: Display Icons

Icon	Function	Icon	Function	Icon	Function
	Auto zero		Control mode with overshoot		Percentage
	Reference level difference (gas head correction)		Control mode with no overshoot		Timed zero
	Control mode active		Filter pressure reading		Tare enabled
	Control mode passive		Linear rate		Zero
	Control mode gauge		Maximum rate		

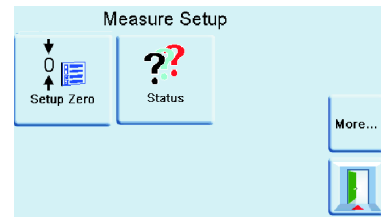
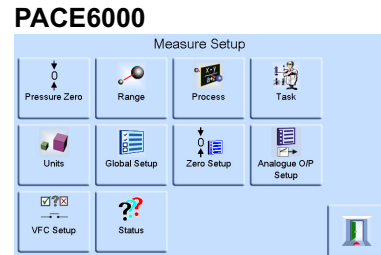
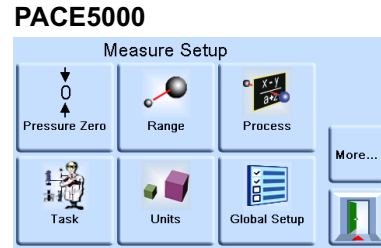
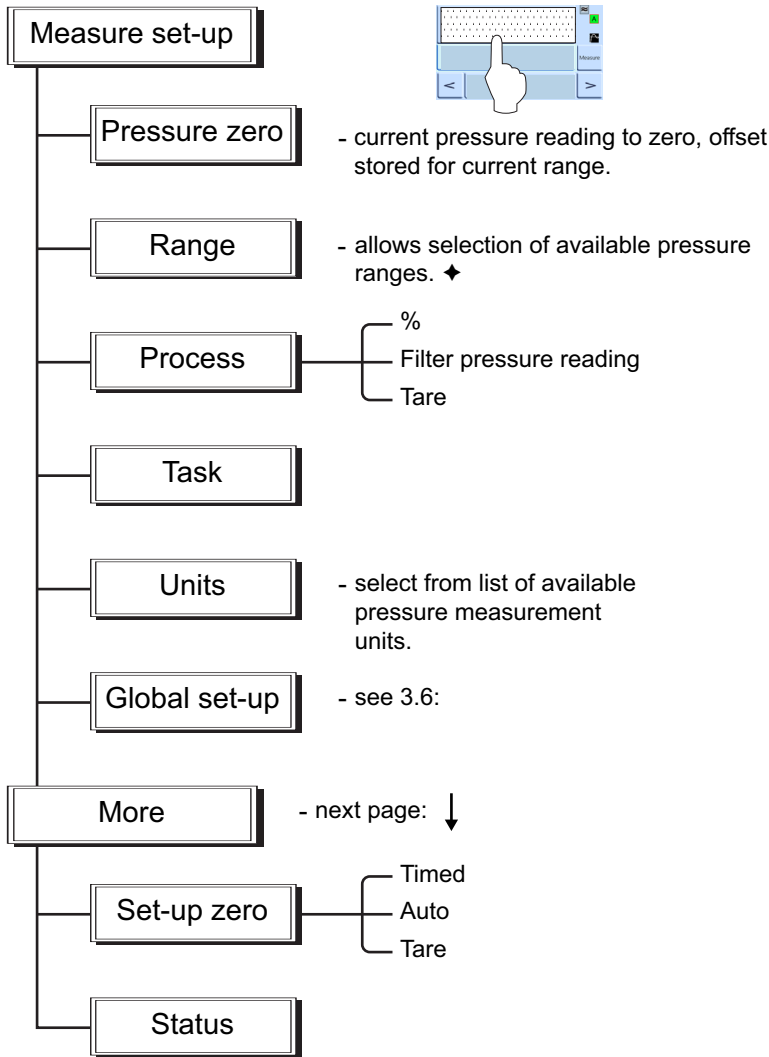

- ◆ Absolute range selection available when barometric option installed. Auto-range only available with two-channel instruments.

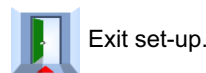

Exit set-up.



Next page of menu options. Loops from last page to first page.

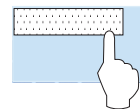

Stores settings and exits set-up.

### 3.3.1 Auto-Range

This function is only available with two-channel instruments.

**Note:** Not all Auto-Range and Task functions are available using the remote communications. This allows more flexibility to the remote programmer.

### 3.3.2 Controller Off – Increasing Set-point

With both controllers in Measure mode, if a set-point within the range of the lower ranged controller is entered and Control is then selected the lower ranged controller controls to the entered set-point.

With both controllers in Measure mode, if a set-point above the range of the lower ranged controller is entered and Control is then selected, then the range is changed to the higher ranged controller and this then controls to the entered set-point.

### 3.3.3 Controller Off – Decreasing Set-point

With both controllers in Measure mode, if a set-point within the range of the higher ranged controller is entered and Control is then selected the higher ranged controller controls to the entered set-point.

With both controllers in Measure mode, if a set-point above the range of the lower ranged controller is entered and Control is then selected, then the higher ranged controller will control to this set-point. When the controller is in-limits then the range is changed to the lower ranged controller and this then controls to the entered set-point.

### 3.3.4 Controller On – Increasing Set-point

With the lower ranged controller in Control mode, if a set-point within the range of the lower ranged controller is entered then the lower ranged controller controls to the entered set-point.

If the set-point is increased to above the lower range but still within the higher range then the lower range controller switches off and that the higher range controller switches on and controls to the entered set-point.

### 3.3.5 Controller On – Decreasing Set-point

With the higher ranged controller in Control mode, if a set-point within the range of the higher ranged controller is entered then the higher ranged controller controls to the entered set-point.

If the set-point is decreased to within the lower range then the higher range controller will control to this set-point. When the controller is in-limits then the range is changed to the lower ranged controller and this then controls to the entered set-point.

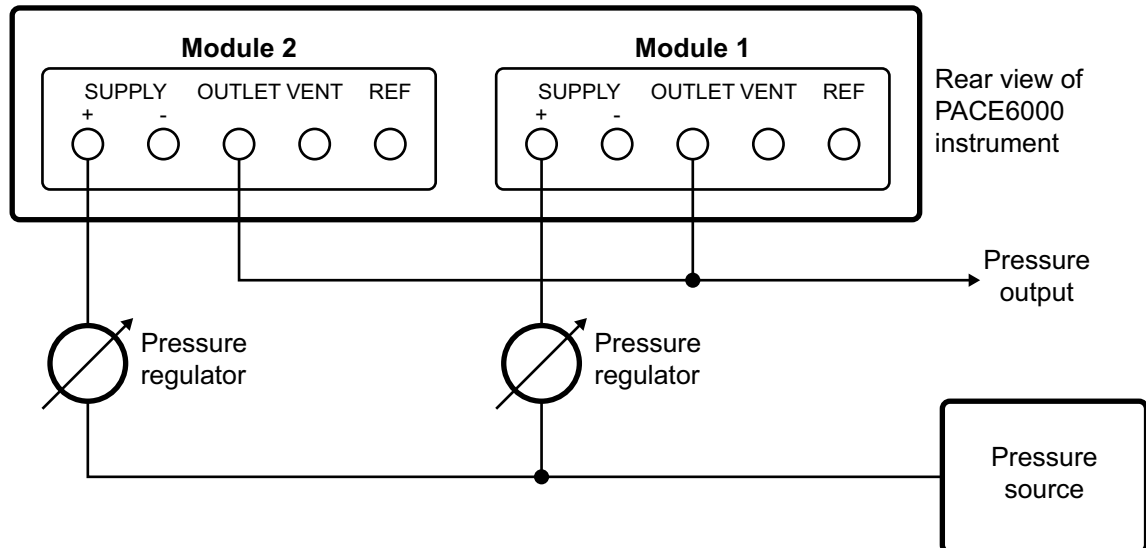

## 3.4 Control Mode

In measure mode, press **Control** and the instrument changes to control mode.

# Chapter 3. Operation

Press **Measure** and the instrument stops controlling pressure and changes to measure mode:

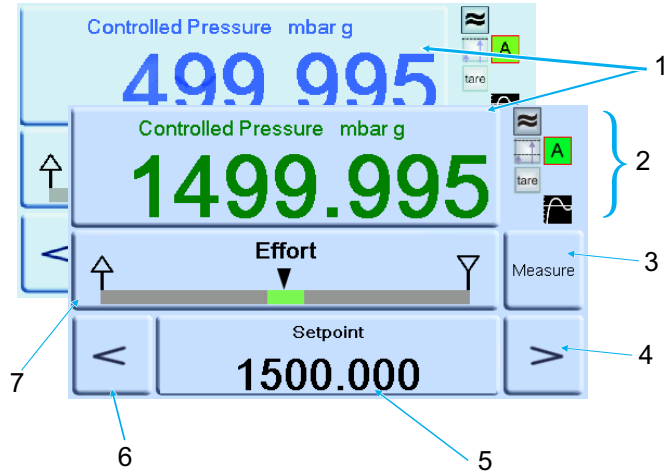

- 1 Current measured pressure value (in-limits green, out of limits blue).
- 2 In active control mode:  
 Pressure reading filter ON.  
 Head (pressure) value applied.  
 Control mode with overshoot.  
 Tare enabled.
- 3 Press to switch between controlled pressure and measured pressure.
- 4 Nudge up.
- 5 Set-point, press and the display changes to numeric keys.
- 6 Nudge down.
- 7 Status area shows effort meter set in global setup, press to enter control setup.

## Icon Function



Active mode - control active, except in measure mode.



Passive mode - when the controller achieves in-limits condition, measure mode is automatically selected.



Gauge mode - when the controller achieves zero gauge in-limits condition, measure mode is automatically selected and the zero valve opens.

### 3.4.1 Controlling to a New Set-point

1. To change the set-point value, touch the set-point area of the screen and the display shows the numeric keys.
2. Set the new set-point value.

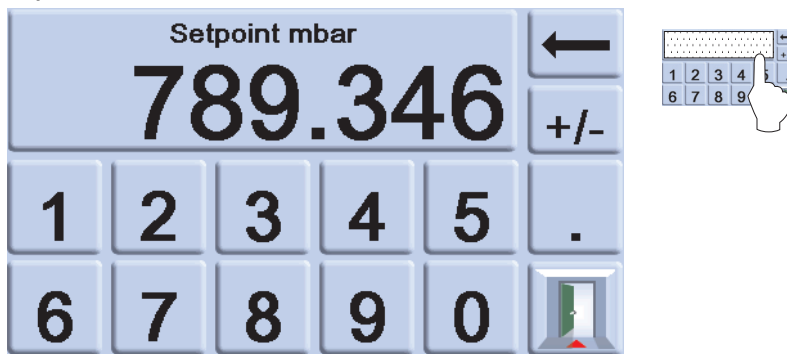

3. If necessary, use the **←** key to remove the last digit in the set-point value display.
4. To save the new set-point, touch the set-point area of the screen. This returns the display to the measured pressure screen and showing the new set-point.

5. Touch the escape  to leave the numeric setting unchanged.
6. To control pressure to the new set-point value press the **Control** key.
7. The display shows the pressure value changing as the instrument controls to the new set-point, at the set rate of change.  
**Note:** When changing from measured to controlled mode the displayed pressure digits change from black (measured pressure) to blue (controlled pressure out of limits) to green (controlled pressure in-limits).
8. If enabled, the effort meter shows the effort the controller exerts to achieve the set-point.
9. The status area can be changed to various displays showing pressure and controller performance.

### 3.4.2 Effort Meter



**Note:** In normal controlled pressure conditions the effort meter stays within the band (green). If the status indicator moves outside the band there may be a leak into or out of the system.

### 3.4.3 Controlling to Ambient/Zero Pressure

1. Use the numeric key display and set the new set-point value to ambient or zero gauge pressure.
2. When the display shows the new set-point value, press the **Control** key.
3. The display shows the pressure value changing as the instrument controls to the new set-point, at the set rate of change.
4. When the display shows ambient or zero pressure, press the **Measure** key to switch off the controller and return to measure mode.

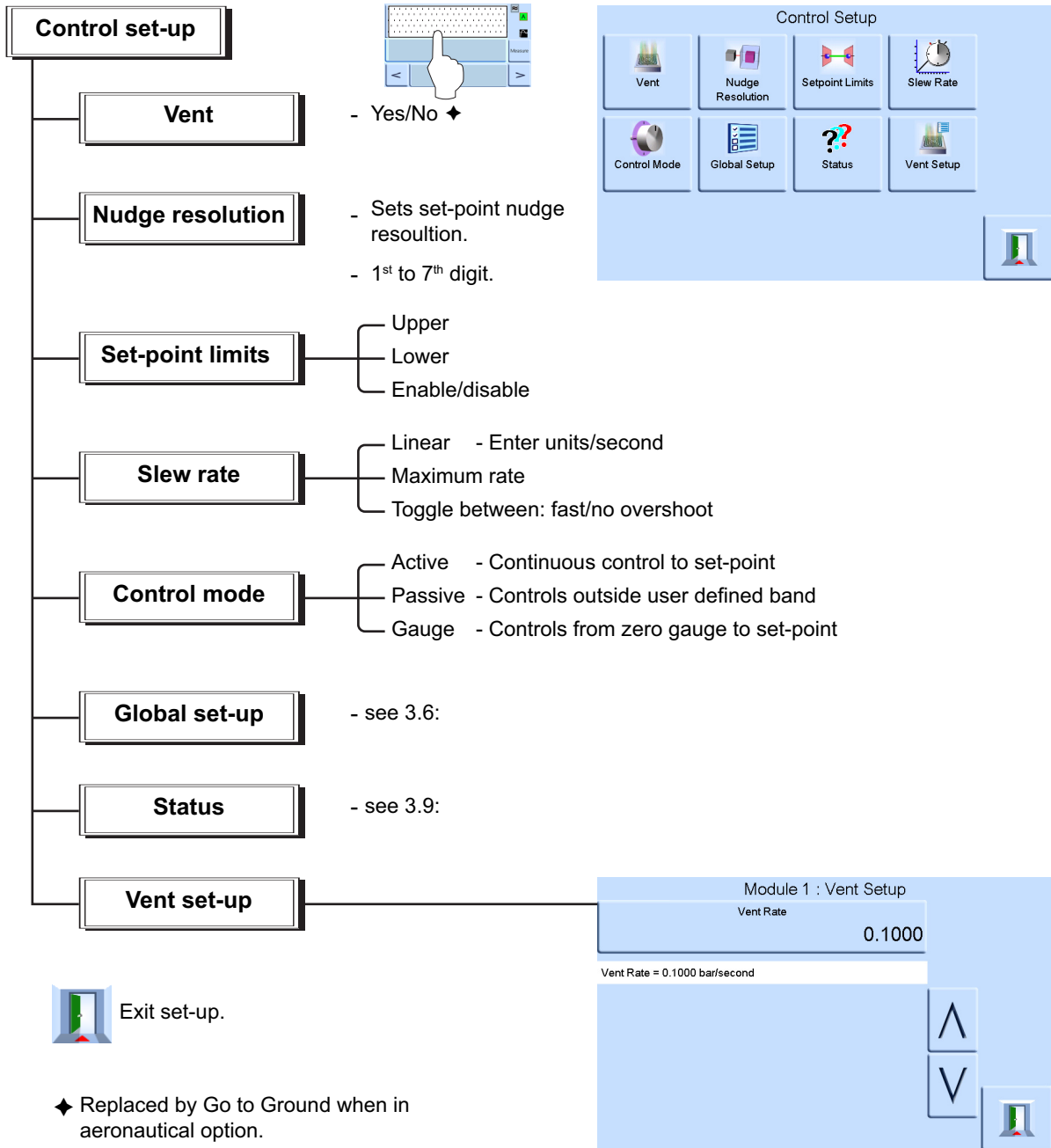

## 3.5 Operation and Example Procedures

### 3.5.1 Introduction

Before operation, the instrument must be connected to the correct electrical and pneumatic supplies. Refer to Section 2, "Installation," on page 3.

Switch the instrument ON, the display shows measured pressure mode (except when regulator mode is selected) and the task set before the power-off.

### 3.5.2 Measure and Control Modes

The instrument operates in the two modes that follow:

- Measure mode, the instrument works as a precision pressure indicator and shows the pressure measured at the output port.
- Control mode, the instrument works as a precision pressure controller and shows the controlled pressure measured at the output port. Pressing Task enables various pre-determined functions:

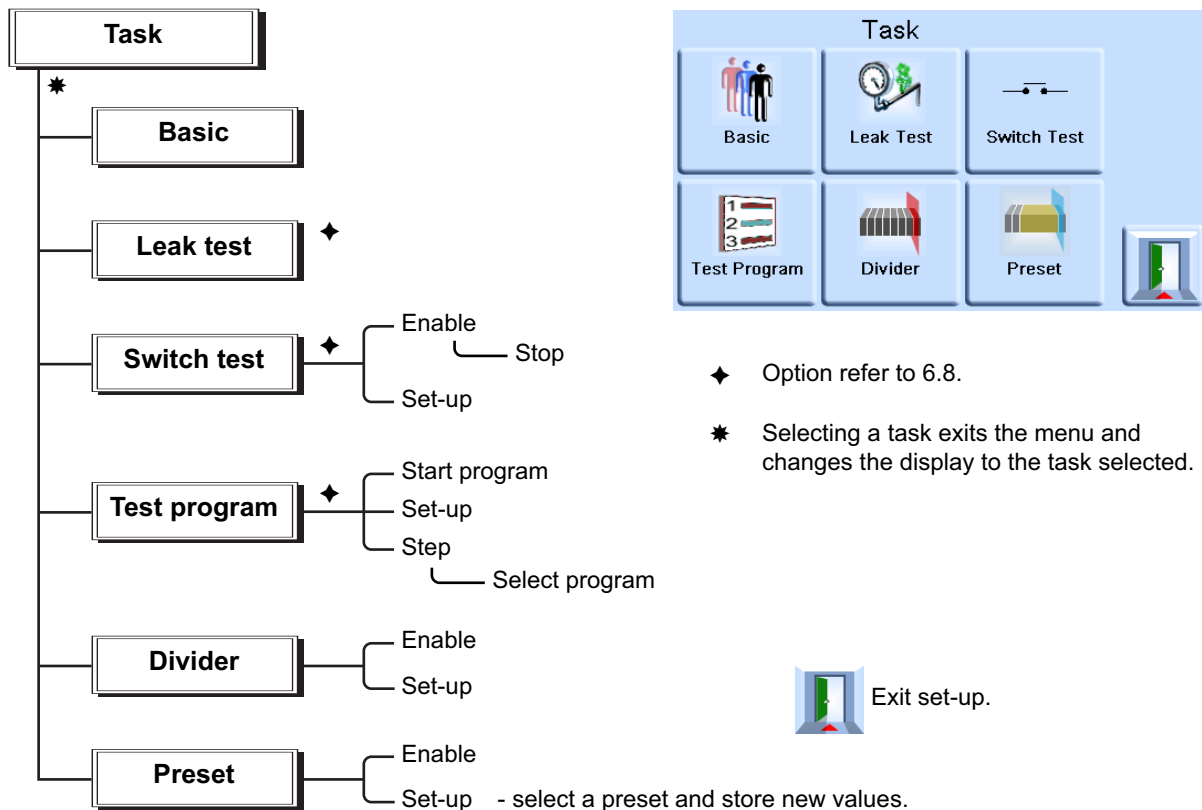

The display shows the task screen. When selected, e.g. Basic, the screen changes to show the selected task.

### 3.5.3 Task



**CAUTION** Use the vent setup to prevent damage to rate-sensitive equipment connected to this controller. The vent slew rate setting is independent of the controller slew rate settings.

To control pressure in the task do the following:

1. Select the required units of pressure measurement from the measure setup menu.
2. Press the status area and enter control setup.
3. Select the required slew rate.

**Note:** The display changes to show the type of slew rate selected.

4. Select the required vent slew rate in vent setup.
5. Return to the task screen. In basic task, use the numeric keys to enter a set-point.
6. Press the status area and enter control setup, select the required slew rate.
7. Press the **Control** key to start controlling pressure.
8. The screen display changes as follows:
  - The current pressure reading changes from black to blue.
  - If enabled, the effort meter indicates the amount of work done (effort) by the controller.

# Chapter 3. Operation

9. When the controller achieves the selected pressure set-point, the screen display changes as follows:
  - The current pressure reading changes from blue to green.
  - If enabled, the effort meter shows the controller effort to keep the pressure at the set-point.
10. On completion of testing, select control setup and select **Vent** to reduce the system pressure to near atmospheric pressure.
 

**Note:** This feature should be used to reduce system pressure to a safe value before disconnecting the Unit Under Test. The vent valve opens and remains open until a key press or receipt of a communications command. Always use the vent function before disconnecting pressure equipment from the output port.
11. Press the **Measure** key to return to measure mode. The screen display changes as follows:
  - The current pressure reading changes from blue/green to black.
  - If enabled, the effort meter indicates the controller at rest.

### 3.5.4 Divider

Select and setup the divider task by pressing **Divider** from the task screen. The divider menu specifies high set-point, low set-point and then divides the span into a number of equal test points (min 2, max 25).

### 3.5.5 Divider Menu Structure

Select required units, Rate, etc. in the setup menus. When Divider is then entered from the Task menu, these test point pressures and number of test points can be set.

By entering control mode, this allows the Divider sequence of test pressures (and controlled at the selected rate).

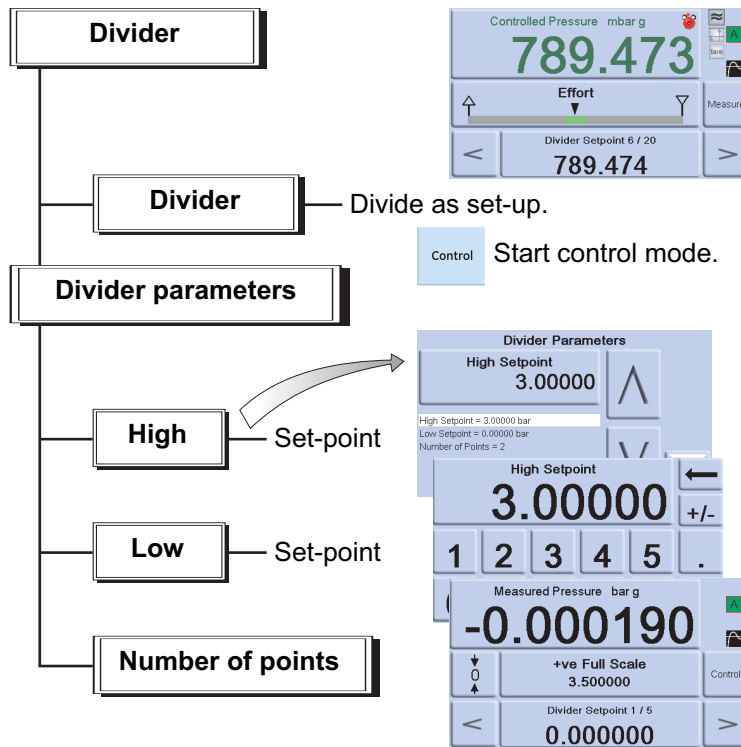

Example:

- i. High set-point = 2 bar
- ii. Low set-point = 0 bar



- iii. Number of points = 5
- iv. Test pressures = 0, 0.5, 1, 1.5 and 2 bar

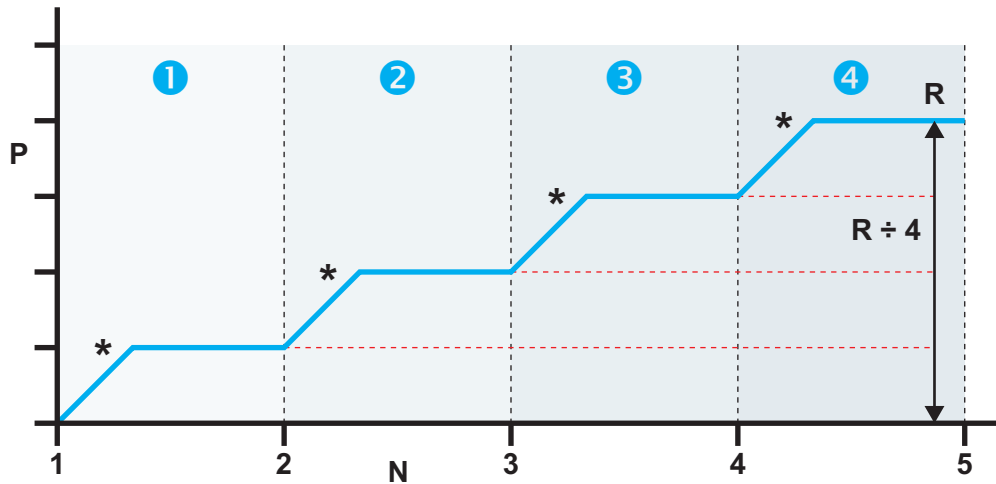

P Pressure  
 N Number of points.  
 R Range between low set-point (1) and high set-point (5).  
 \* Controlled pressure to each set-point.

### 3.5.6 Preset

The **Preset** function allows individual set-point values can be defined for each of 25 set-points.

The setup function displays a preset number.

Pressing the soft key for that number assigns a pressure value to the key.

After setting all the 25 preset pressures, enter control mode.

Press a soft key to change to the pressure assigned to that key (and \* controlled at the selected rate).

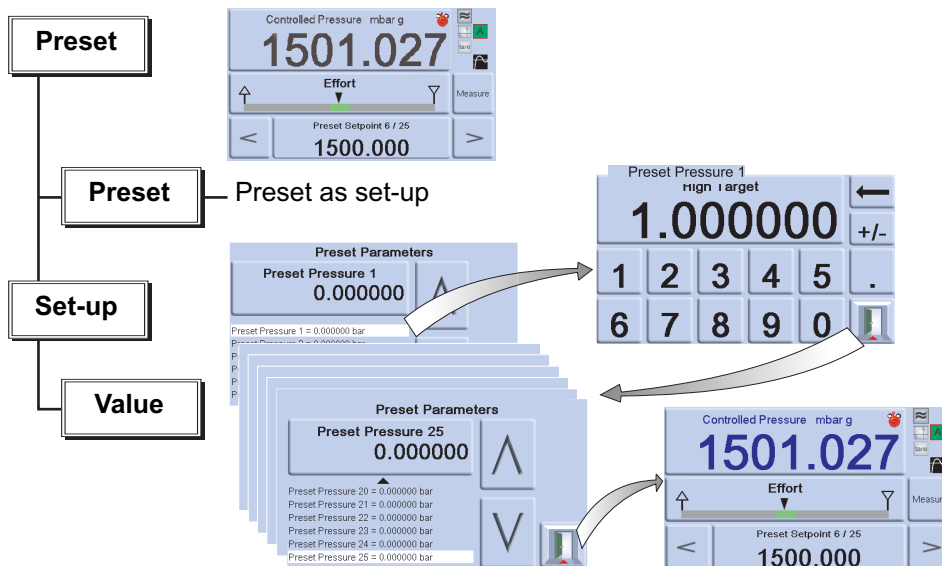

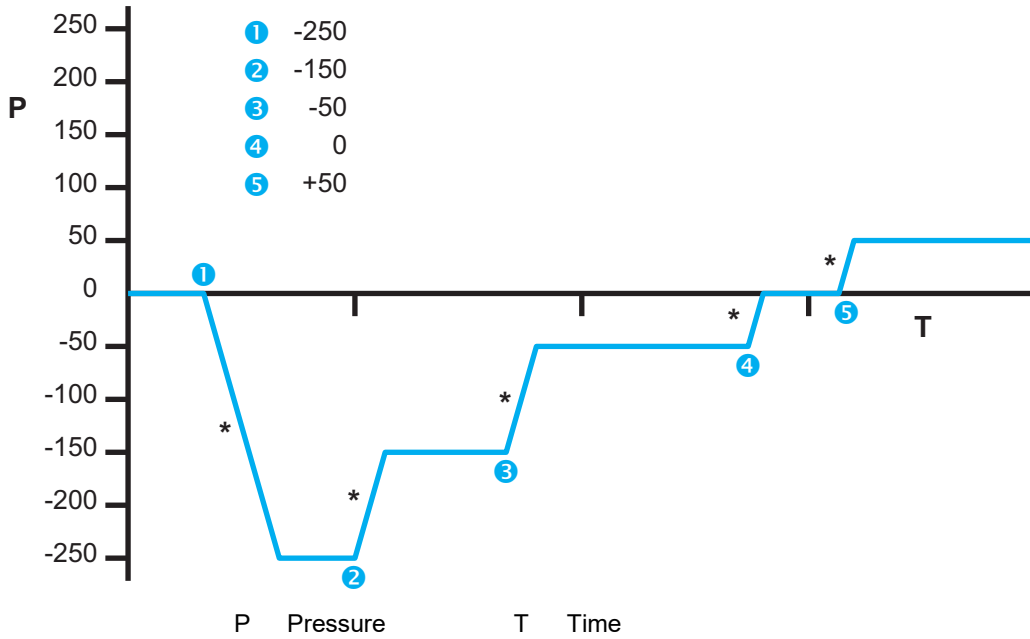

### 3.6 Global Setup Selections

Global setup selections provide access to the instrument’s settings for both measure and control modes.

The setup menu that follows provides PIN-protected access to the supervisor setup and calibration.

Pressing Global Setup from measure or control setup menu changes the touch-screen display to show the following selections:

- Supervisor Setup
- Calibration
- Save/Recall User Setup
- Display

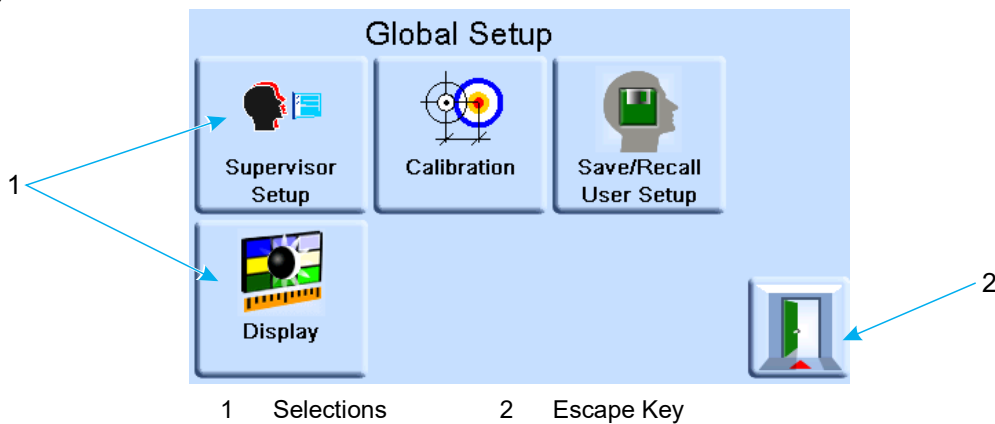

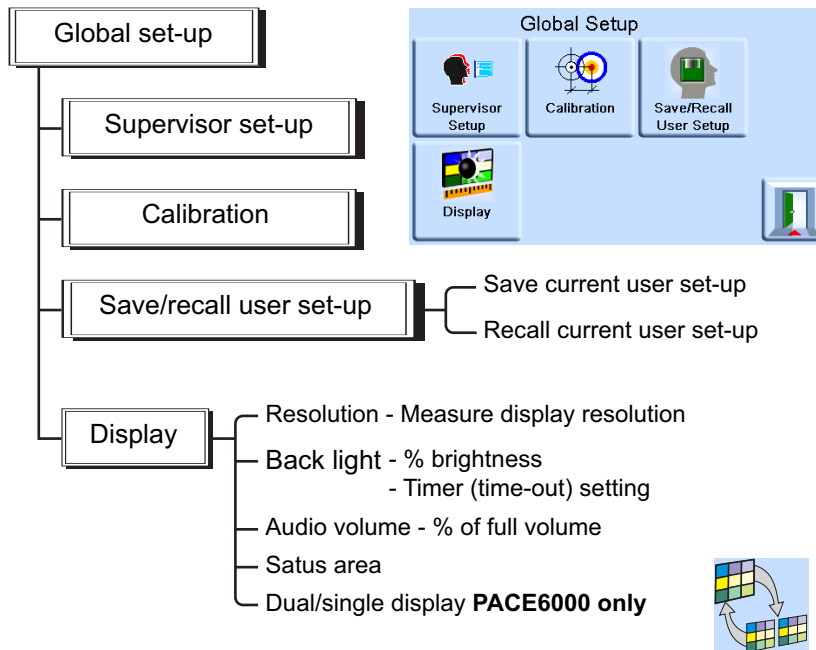

### 3.6.1 Status Area Settings

Enables the user to view an operating condition or parameter of the instrument:

Setting	Description
Full-scale	Pressure in current selected units of the pressure range.
Source	Positive and negative source pressure values in current selected units.
Effort meter	Indicates controller effort.
In-limits meter	Indicates controller in-limits condition and time to in-limits.
Module logic I/P	Indicates status condition of logic input of control module.
Vent and +ve FS	Enables vent selection and shows full-scale pressure in current selected units.
Zero and +ve FS	Enables zero selection and shows full-scale pressure in current selected units.
Rate	Indicates slew rate set.
Barometric	Displays barometric pressure.
Tare	Indicates tare condition and value.
Analog Output	Shown if option is installed.
P1 - P2	Displays Module 1 pressure minus Module 2 pressure (P2 - P1).

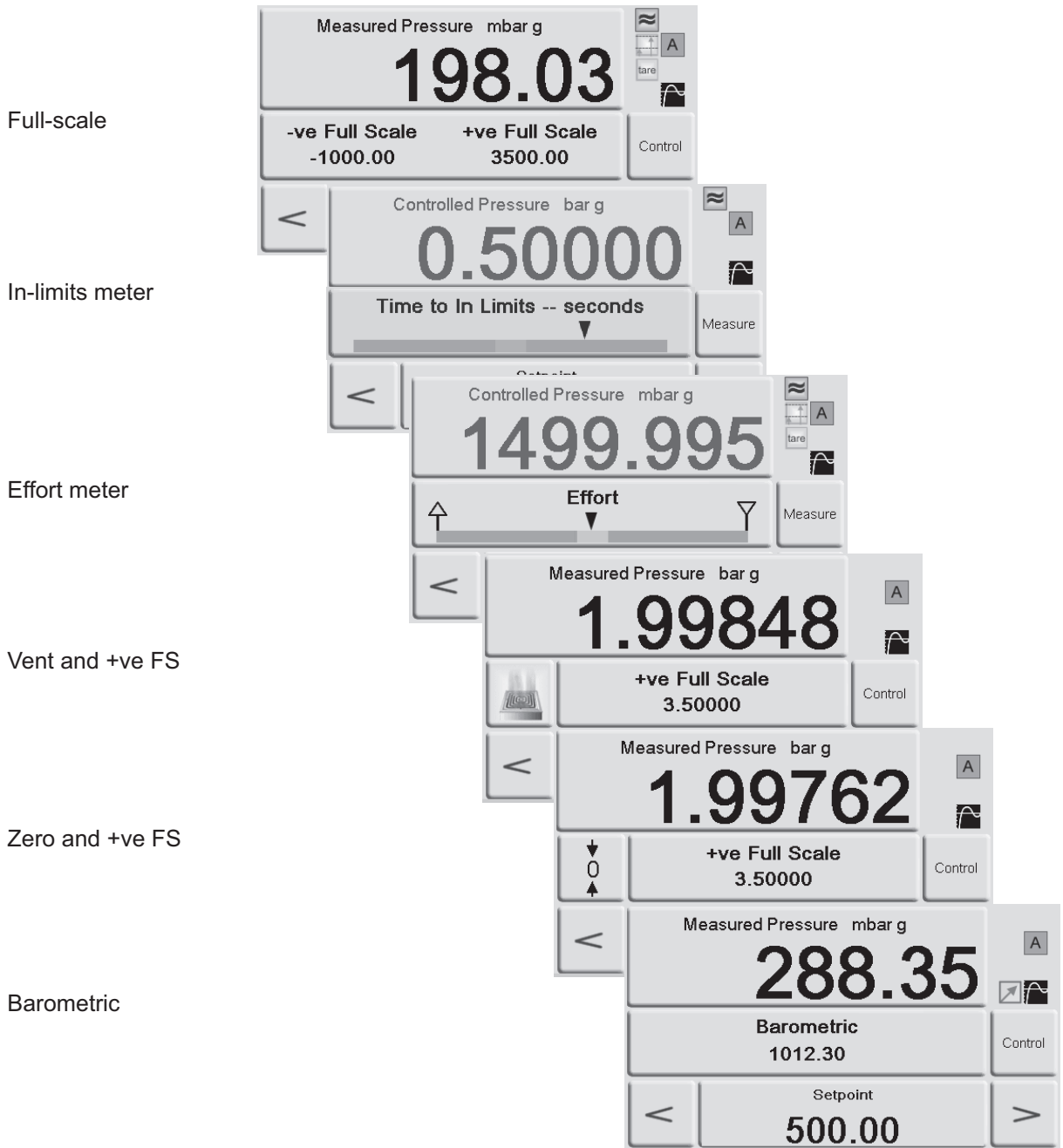

Figure 3-3: Status Area Examples

### 3.7 Barometric Reference Option

If installed, this option allows absolute or gauge pressure range selection. To obtain absolute pressure the instrument uses a summation of gauge pressure and barometric pressure (measured by the barometric sensor). Refer to Section 6.10, "Option Enable Process," on page 58 and the Data Sheet for the performance of barometric reference and precision of absolute ranges.

### 3.8 Supervisor Setup

The supervisor setup menu provides facilities for changing settings. These are made during installation.

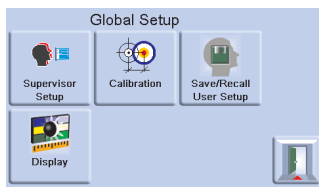
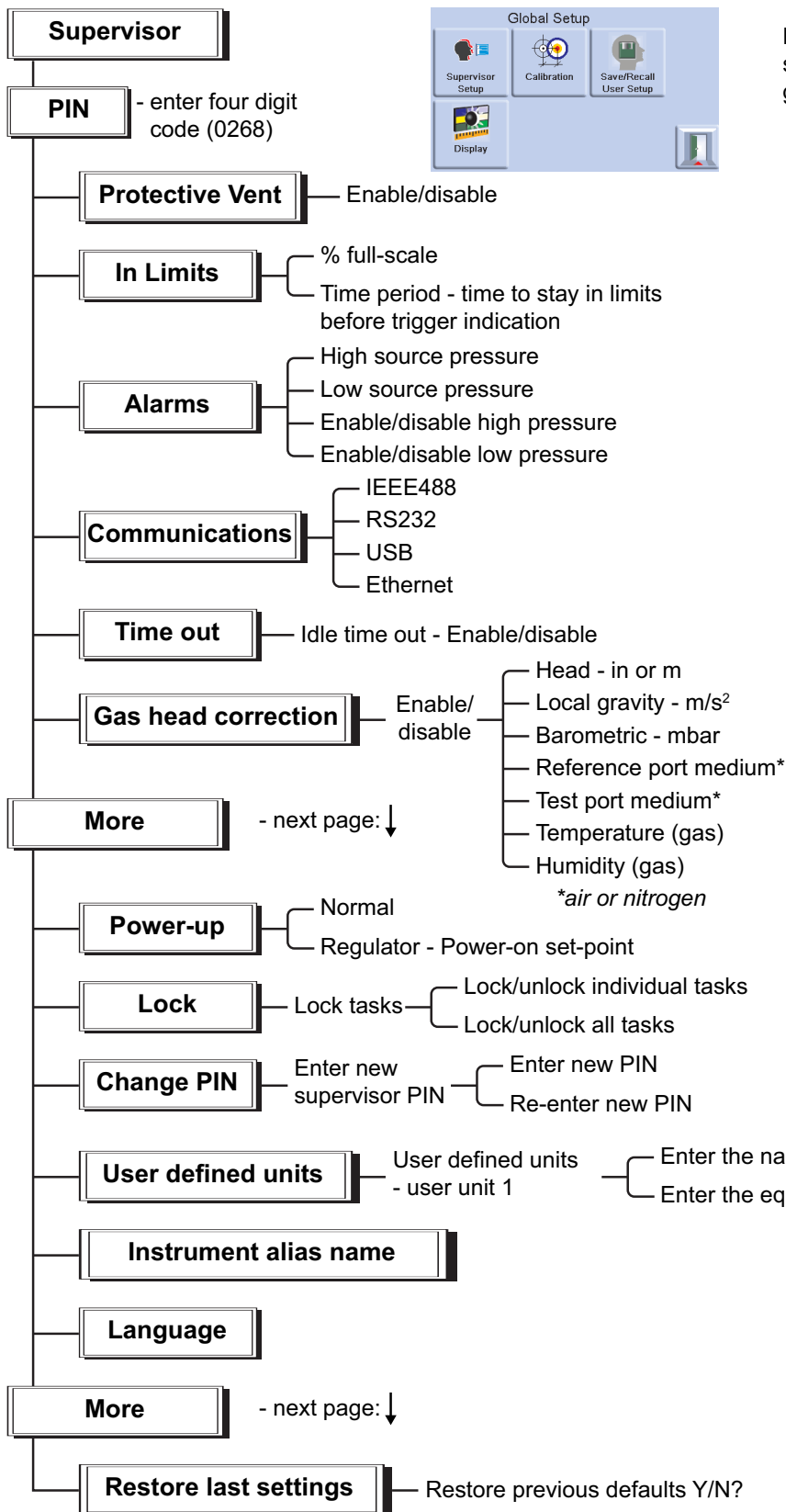

Pressing the escape key stores settings and returns to global set-up.

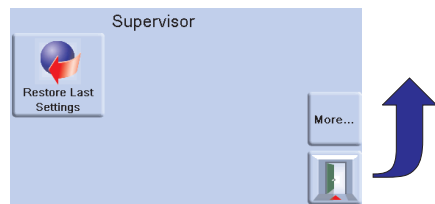
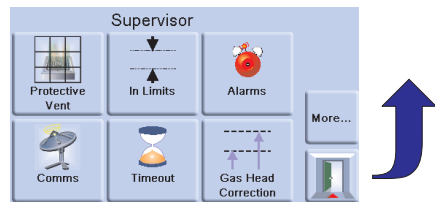

### 3.9 Instrument Status

The control setup menu provides access to the status of the instrument:

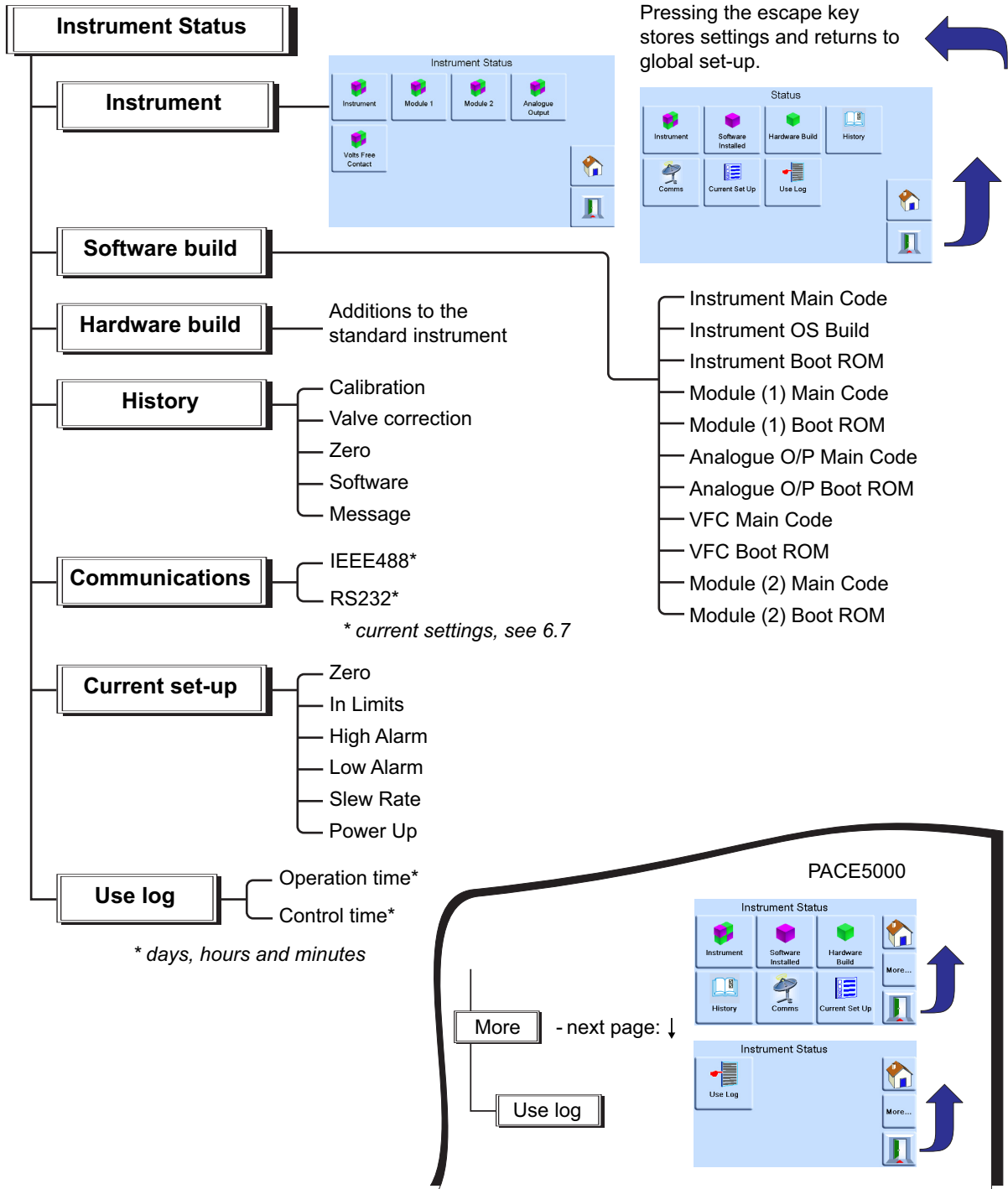

### 3.9.1 Software

Software history, in the status menu, provides read only information on the current software in the instrument.

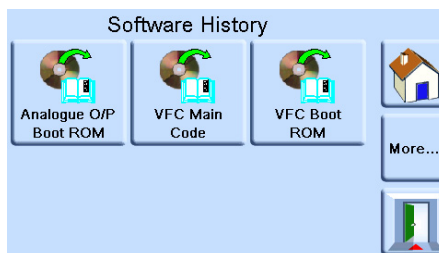
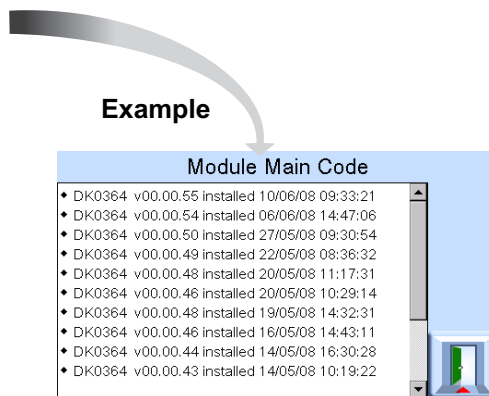
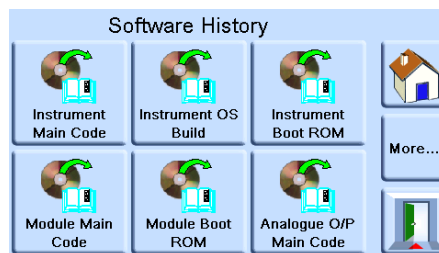
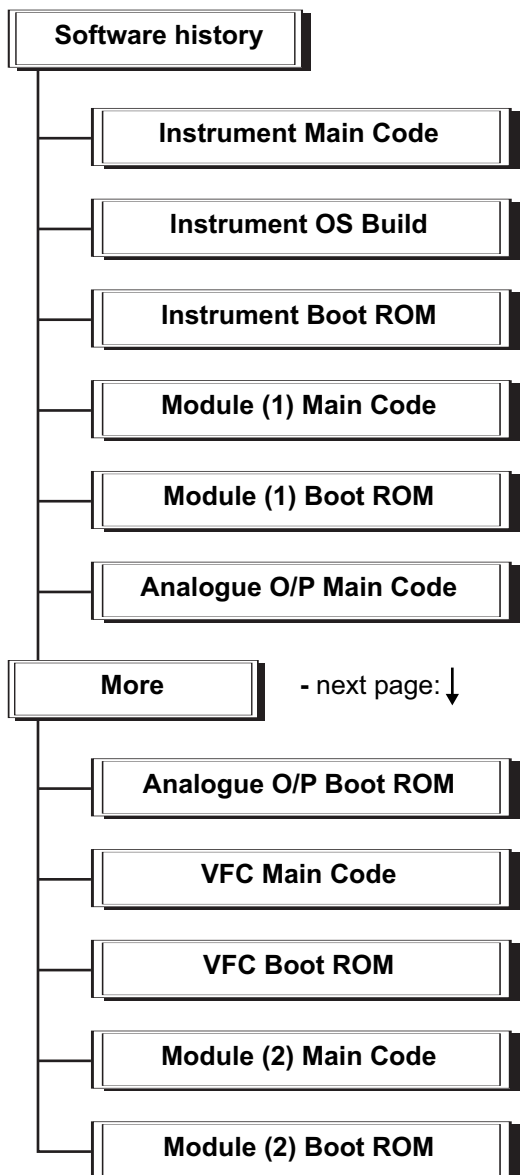

Exit set-up.



Next page of menu options.  
Loops from last page to first page.





## 4. Maintenance

### 4.1 Introduction

This section contains procedures for routine maintenance and the replacement of components. Refer to Section 5, “Testing and Fault Finding,” on page 41 and listed Table 4-2.

**Table 4-1: Maintenance Tasks**

<b>Task</b>	<b>Period</b>
Visual Inspection	Before use
Test	Before use
Cleaning	Weekly <sup>a</sup>
Calibration	12 months <sup>b</sup>
Replace Pressure Control Module Filters	Determined by usage.
Replace Pressure Control Module	Pressure control module operating hours.

- a. May change; depends on usage (e.g. rack mounted, bench top) and environment (e.g. humidity, dust).
- b. May change; depends on the required accuracy.

### 4.2 Visual Inspection

Inspect for obvious signs of damage and dirt on the following:

1. External of the instrument.
2. Power supply connector and power lead.
3. Associated equipment.

Damaged parts must be replaced, contact Druck Service.

### 4.3 Cleaning

Do not use solvents for cleaning. Clean the front panel with a damp lint-free cloth and mild detergent.

### 4.4 Test

Do a standard serviceability test Section 5.2, “Standard Serviceability Test,” on page 41.

### 4.5 Software Update

To update the PACE5000 / PACE6000 internal software, use the following procedure:

1. Insert a USB memory device into an internet connected PC.
2. Open Windows Explorer and select the USB memory device root folder. Delete the following folders if they are present:
  - i. DPI
  - ii. Controller
  - iii. OS
3. Using a web browser go to the following Druck PACE support page:

[https://www.bakerhughesds.com/download-center?bh\\_ref=gemeasurement.com](https://www.bakerhughesds.com/download-center?bh_ref=gemeasurement.com)

## Chapter 4. Maintenance

---

4. In the search window, select the following and hit Apply:

Search Term	Entry
Industry	(leave blank)
Category	Pressure Controllers - PACE
Product	Select PACE5000 or PACE6000
Name	(leave blank)

5. Select the software history file and open this file. Read this file to become aware of the latest and previous software version and any particular fixes needed.
6. Select the most recent dated software and highest alphanumeric revision, unless an older revision of software is required.
7. Download the software file, which is a zip file.
8. Once the zip file has completed download, save the zip file to the PC desktop. Unzip the contents of the zip file to the root folder of the USB memory device. Ensure that the following three folders have been created in the root folder of the USB memory device:
- DPI
  - Controller
  - OS
9. Eject the USB memory device from the PC.
10. Ensure that the PACE is powered off.
11. Inset the USB memory device into the rear panel USB port of the PACE.
12. Power-up the PACE.
13. Once the PACE has powered up, navigate through the following on-screen menus:
- Select the top measured pressure area of the display.
  - Select the Global setup icon.
  - Select the Calibration icon.
  - Enter the PIN number: 5487
14. The PACE display now shows icons for each software component that can be updated. This depends on the current installed version compared to the software history document.
15. Update the software in the following order. Follow the on-screen prompts during the update process.
- Control Module 1.
  - Control Module 2 (if fitted).
  - OS software.  
**Note:** The PACE must remain powered-up during the OS software update. Failure to do so will result in non-recoverable damage to the PACE.
  - Instrument software.
16. Once the software updates have been completed, turn off the PACE.
17. Turn the power back on to the PACE.
18. Wait until PACE displays the pressure measurement screen.
19. Verify the installed software version against the software history document.

## 4.6 Replacement Parts



**WARNING** Turn off the source pressure and carefully vent the pressure lines (tubes) before disconnecting the pressure lines (tubes) for maintenance. Proceed with care.

Isolate the instrument power supply before replacing parts. The instrument contains lethal voltages when power is applied.

Use only the replacement parts listed in Table 4-2.

**Table 4-2: Replacement Parts List**

Part Number	Description
-	Fuse T2AH250V (PACE5000)
-	Fuse T5AH250V (PACE6000)
IO-FILTER-KIT	Filter Kit
CM#-##### <sup>a</sup>	Pressure Control Module

a. Refer to data sheet.

### 4.6.1 Fuse Replacement

Refer to Section 5, “Testing and Fault Finding,” on page 41 when to replace the fuse.

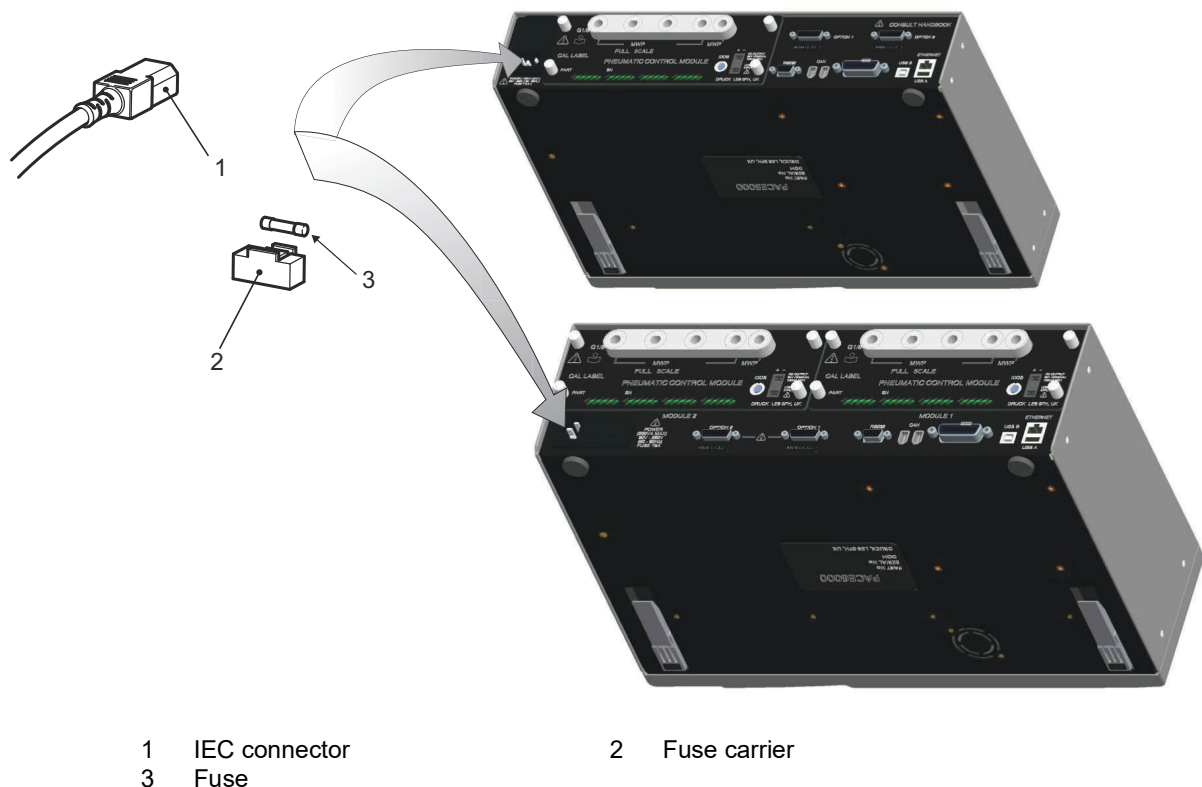

**Figure 4-1: Fuse Replacement**

#### 4.6.1.1 Remove Fuse

Refer to Figure 4-1.

1. Set the power switch to OFF. If the PACE is not rack-mounted, got to step 3.
2. For access to rack-mounted instruments, the following actions maybe required:
  - a. Isolate pneumatic supplies.

## Chapter 4. Maintenance

- b. De-pressurize all pressure supply inlet and output lines.
- c. Partially or completely withdraw the instrument.
3. Isolate the power supply to the instrument and disconnect the IEC power supply connector (1).
4. Remove the fuse carrier (2) from the power supply input socket assembly.
5. Remove the fuse cartridge (3).

### 4.6.1.2 Replace Fuse

Refer to Figure 4-1.

1. Check for the correct type of fuse. Refer to Table 4-2.
2. Replace the fuse.
3. Refit the fuse carrier (2) in the power supply inlet socket assembly.
4. Refit and reconnect rack-mounted units. Refer to Section 2, "Installation," on page 3.
5. Switch on the power supply and set the power supply switch to ON.
6. If the fuse blows immediately with power-on, contact the manufacturer or Service Agent.

### 4.6.2 Pressure Control Module Filters

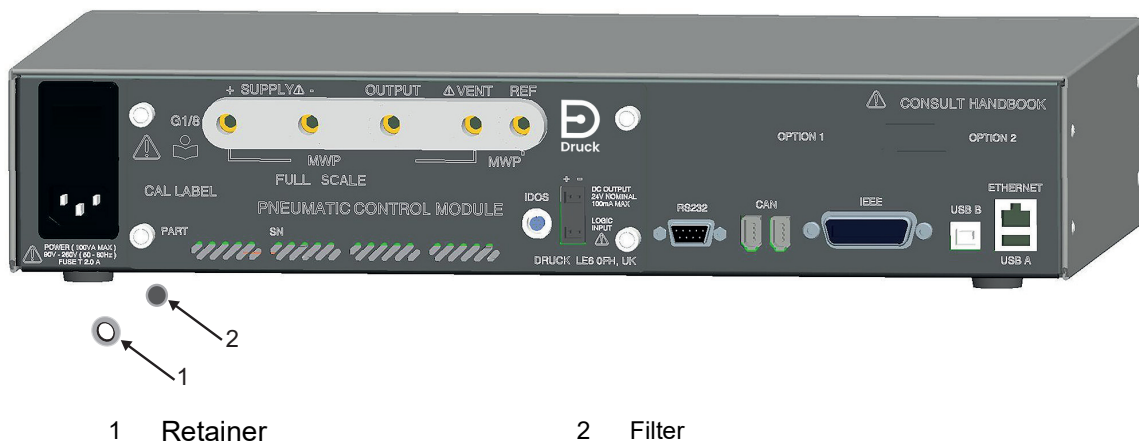

**Figure 4-2: Pressure Control Module Filter Replacement**

#### 4.6.2.1 Remove Filter

Refer to Figure 4-2.

1. Set the power switch to OFF. If the PACE is not rack-mounted, got to step 3.
2. For access to rack-mounted instruments, the following actions maybe required:
  - a. Isolate pneumatic supplies.
  - b. De-pressurize all pressure supply inlet and output lines.
  - c. Partially or completely withdraw the instrument.
3. Isolate the power supply to the instrument and disconnect the IEC power supply connector.
4. Disconnect the pneumatic pipes (tubes) from the pressure control module.
5. Release the four cross-head screws (drive size 2) securing the pressure control module in the instrument case.
6. Remove the pressure control module to access to the filters.
7. Use a 5 mm hexagonal key, to release the filter retainer (1).
8. Remove the five filters (2). If necessary, invert the pressure control module to aid removal.

#### 4.6.2.2 Replace Filter

Refer to Figure 4-2.

1. Insert five new filter into each of the pressure connections.
2. Use a 5 mm hexagonal key, to secure each filter retainer. Do not over tighten.
3. Refer to Section 2, "Installation," on page 3.

#### 4.6.3 Pressure Control Module Replacement



**WARNING** Turn off the source pressure and vent the pressure lines before disconnecting or connecting the pressure lines. Proceed with care.

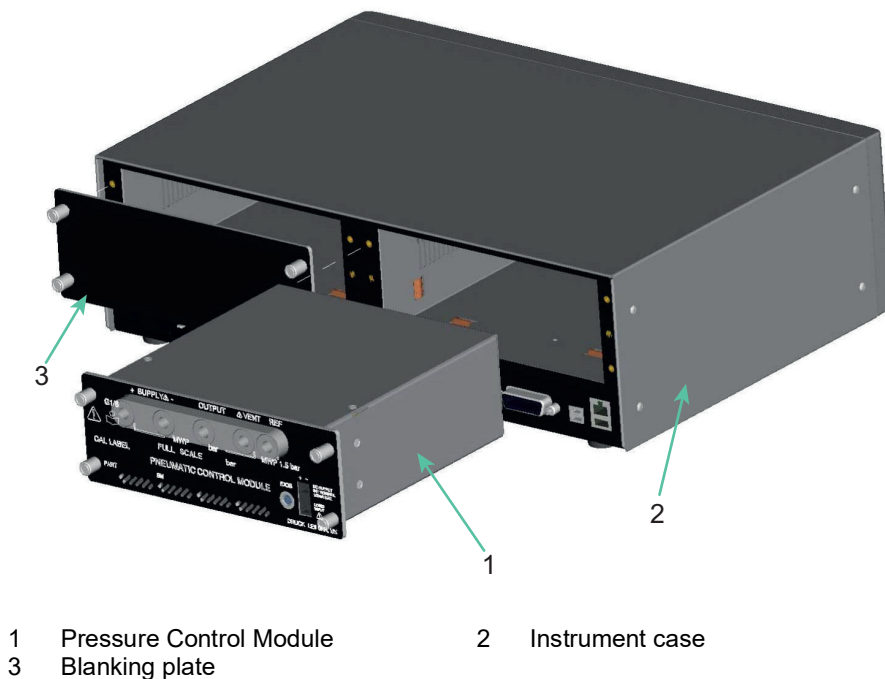

- |   |                         |   |                 |
|---|-------------------------|---|-----------------|
| 1 | Pressure Control Module | 2 | Instrument case |
| 3 | Blanking plate          |   |                 |

**Figure 4-3: Pressure Control Module Replacement**

##### 4.6.3.1 Remove Pressure Control Module

Refer to Figure 4-3 and Section 2, "Installation," on page 3.

1. Release the four cross-head screws (drive size 2) securing the pressure control module in the instrument case.
2. Remove the pressure control module from the chassis.
3. Fit the blanking plate (3) (supplied) to protect the internal components.

##### 4.6.3.2 Replace Pressure Control Module

Refer to Figure 4-3 and Section 2, "Installation," on page 3.

1. Fit a fully compatible pressure control module (1) into the instrument case (2).
2. Secure the four cross-head screws (drive size 2) securing the pressure control module in the instrument case.



## 5. Testing and Fault Finding

### 5.1 Introduction

This section details the standard serviceability test. Table 5-1 for possible faults, and the response.

The PACE contains a self-test and diagnosis system that continuously monitors the performance of the instrument. At power-up, the system performs a self-test.

### 5.2 Standard Serviceability Test



**CAUTION** Always release pressure before disconnecting pressure equipment.

The following procedure shows if the PACE is serviceable and checks functions and facilities of the instrument.

1. Connect the instrument. Refer to Section 2, "Installation," on page 3
2. Connect a pressure measurement device to the output port.
3. After power-up, select measure setup.
  - a. Select the required units of pressure measurement from the measure setup menu.
  - b. Press the status area to enter control setup.
  - c. Select the effort meter.
  - d. Select the required control slew rate and vent rate.
  - e. Press set-point and, using the numeric keys, set a value within the pressure range of the instrument.
  - f. Check the screen display shows the following:
    - Selected units of pressure measurement.
    - Selected type of slew rate.
    - Set-point.
  - g. Press the **Control** key to start.
4. The screen display changes as follows:
  - a. The measured pressure digits change from black to blue and indicates the pressure value changing towards the set-point.
  - b. If enabled, the effort meter indicates the work effort of the controller.
5. When the controller achieves the selected pressure set-point, the screen display changes as follows:
  - a. The color of the displayed pressure value changes from blue to green indicating that the controller is within the in-limits tolerance.
  - b. If enabled, the effort meter shows the controller effort to keep the pressure at the set-point.
  - c. Check the pressure measurement device indicates the approximate pressures generated by the PACE controller.
6. Select vent and the pressure reduces to atmospheric pressure at a controlled rate (vent rate).
7. The test is completed when the controller is at atmospheric pressure.

**Note:**

## Chapter 5. Testing and Fault Finding

- The vent valve opens and remains open until OK is pressed.
- Always use the vent function before disconnecting pressure equipment from the output port.
- The instrument automatically returns to measure mode.
- The color of the displayed pressure value changes to black.

After a successful serviceability test the instrument is ready for use.

### 5.3 Fault Finding

Check the faults and responses, refer to Table 5-1. If the fault persists, refer to Section 5.4.

**Table 5-1: Fault Diagnosis**

<b>Fault</b>	<b>Response</b>
Power supply connected, display not lit.	Check rear panel switch set to on. Check fuse and, if necessary, replace Check electrical power supply fuse or circuit breaker.
24 V dc output intermittent.	Over-load internal self-resetting fuse operating. Reduce load current to specified value.
Instruments functions, but does not reach all set-points.	Check pneumatic supplies for correct pressures. Check system for leaks.
In measure mode with output port sealed, the pressure continues to increase or decrease.	Increasing pressure, leaking Apply control valve. Decreasing pressure, leaking Release control valve. Confirm by isolating pressure supplies. Contact Druck approved service agent.
Display pressure reading in red	Over-range, use vent de-pressurize or vent manually.
Instrument enters measure mode without user request or command.	Idle time-out enabled but timeout period setting too short.
Instrument will not zero.	Blocked vent port. Check for blockage. Contact approved service agent for repair.
Instrument controlling to set-point, no pneumatic output	Blocked isolation valve. Contact approved service agent for repair.
Erratic or inaccurate zero	Leaking isolation valve. Reference port restrictor not fitted. Contact approved service agent for repair.
Increased gas consumption. Unstable control at set-point or does not achieve set-point.	System leak. Carry out leak test. Contact approved service agent for repair. Reference port restrictor not fitted.
If the controlled pressure stays within the tolerance band and the pressure at the output is within limits. If the controller status indicator is outside the tolerance band.	Leak in the system or the supply pressure differs from the pressure for which the control valves have been characterized.

### 5.4 Approved Service Agents

For the list of service centers:

**Druck.com**



## 6. Reference

### 6.1 Installation Notes

The PACE instrument pressure controller/calibrator requires an independent pressure supply and set of connections. The exception is the reference connection, this provides a reference to atmosphere for gauge sensors and barometric sensors.

The instrument must have the correct supply pressure and a suitable supply medium. Refer to data sheet specification.

The type and density of the supply gas does not affect the accuracy of pressure measurement, assuming that the Unit Under Test (UUT) is at the same height as the controller or gas head correction is accurately set.

#### 6.1.1 Gas Supply

For normal operation the instrument requires a positive supply of at least 110% of range but less than the MWP, with a gas regulator.

For absolute operation, negative gauge operation or, if the installation requires a fast response around atmospheric pressure, a vacuum source must be connected to the negative supply. For recommended configurations Figure 2-6, Figure 2-7 & Figure 2-8.

To achieve control performance the source pressure must be maintained at 10% full-scale above the required set-point.

Controller performance is maintained during slow variations in source pressure down to a source pressure of 20% full-scale range.

#### 6.1.2 Supply Conditioning Equipment

Supplies should be provided with an isolation valve and any other necessary conditioning equipment.

**Note:** For ranges above 100 bar (1450 psi), protect the control module from over-pressure by using a suitable protection device such as a relief valve or bursting disc. This must be fitted to limit the applied supply pressure to below the MWP.

#### 6.1.3 Maximum Working Pressure

If the measured +ve source pressure exceeds the limits below then display a persistent message box as shown.

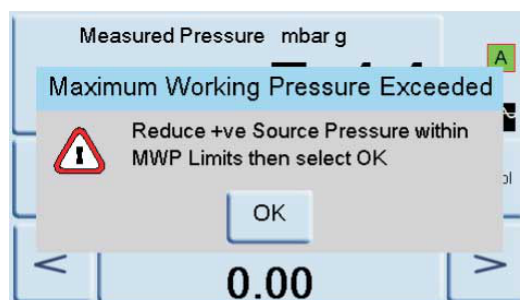

Clear this message by selecting "OK".

#### 6.1.4 Supply Contamination

Supplies may need the removal of water, oil or particulate contamination. Any water in the compressed gas supply will be in vapor form, i.e. non-condensing and must be removed using a mist filter.

Oil must be completely removed as this causes a rapid deterioration of the control valve performance.

## Chapter 6. Reference

---

The compressed gas supply must not contain particulates and must be removed using a particulate filter. Do not use a compressed gas supply containing corrosive material.

### 6.1.5 Systems without a Negative Supply

Without a negative supply (vacuum pump), release the positive pressure from the system to atmosphere through the negative supply port.

The release from the negative port must be piped away to where the discharge causes no disturbance or hazard. A diffuser may be fitted to the negative supply port to diffuse air flow.

The need for a Negative Supply (for Optimum Performance)

### 6.1.6 General

Supply pressures (at least 110% of range but less than the MWP) there must be a difference of 10% of full-scale between the supply pressure and the maximum output pressure. When operating at positive or negative full-scale, there must be a pressure difference between supply and output to cause a gas flow.

### 6.1.7 Operating Near Atmospheric Pressure or Below

Any controller operating near atmospheric pressure or below requires a vacuum pump or other negative supply connected to the negative supply port for optimum performance. Without a vacuum supply, as the output pressure approaches atmospheric pressure, the differential pressure approaches zero resulting in a reduced flow to the output.

Reduced flow causes an increase in the time to control to atmosphere, especially with large user volumes, and an increased overshoot at low pressures. Refer to Figure 2-6, Figure 2-7 and Figure 2-8.

### 6.1.8 Vacuum Pump

Each PACE Control Module has a vacuum sensor. Connect a vacuum pump to the -ve supply port. The higher the flow rate of the vacuum pump the better the PACE control performance. Low pressure ranges < 700 mbar require vacuum regulation or the use of the negative gauge pressure generator IO-NEG-G-GEN-1 option.

A vacuum supply should be used for:

- Absolute ranges.
- Negative gauge ranges.

A vacuum supply improves:

- Time to reduce system pressure at pressures below 2 bar (30 psi), full-scale.
- Control stability near atmospheric pressure.
- Overshoot at low pressures.
- Performance at or near gauge zero.

## 6.2 Operational Requirements



**CAUTION** A contaminated UUT must have additional in-line filters connected between the output port and the UUT to prevent contamination of the instrument.

### 6.2.1 Negative or Vacuum Supply

The negative supply for absolute control does not need to be regulated. Any variation between this and absolute zero will affect instrument operation if controlling at low absolute pressures.

## 6.2.2 Oil Contamination

Precautions must be taken against oil transfer to the instrument.

A normally-open venting solenoid connected to atmosphere and the pump. When the pump supply is switched off, the valve opens allowing atmospheric pressure to enter the pump directly rather than through the pipe (tube) to the instrument.

**Note:** If the above is not done, oil may progressively move up the supply pipe (tube) and into the instrument.

## 6.2.3 Pump Performance

Recommended for ranges above 2 bar (30 psi) gauge, positive full-scale:

1. When installing a vacuum supply, protect the vacuum pump against the discharge of positive pressure by the controller into the vacuum pump. This may result in reducing vacuum pump performance.
2. Use a check valve in the negative supply to vent excess pressure to atmosphere if the vacuum pressure rises above atmospheric pressure. The check valve should be installed on the instrument side of a volume which is approximately equal to the system volume. The volume slows any rapid pressure rise giving the vacuum pump time to reduce the pressure.

**Note:** A wide bore vacuum pipe (tube) can have enough volume. When used with a check valve, this could provide the necessary overpressure protection.

## 6.2.4 Venting

Either a zero or vent operation uses the vent port.

## 6.2.5 Vent

The system gas at the output pressure can be released from the vent port. Unrestricted gas flow occurs in this operation. Use a controlled method to reduce the system pressure, at a controlled rate, to near atmospheric pressure then select vent.

## 6.2.6 Zero

During a zero operation only the internal volume of the instrument vents to atmosphere. Do not obstruct the vent port. To diffuse gas exhaust, a diffuser may be fitted to the vent port.

## 6.2.7 Output Port

The output port provides the controlled test pressure to the UUT.

## 6.2.8 Reference Port

The reference port provides the negative pressure to the gauge sensor and to the barometric reference (option). Gauge sensors use this port identified as "REF". For gauge sensors (without a barometric reference) small pressures can be applied. Refer to Data Sheet. All other pressure measurements require the port to be opened to atmosphere. When in gauge mode, the instrument shows the pressure difference between the reference port and the output port.

**Note:** This is not a true differential operation as there is no true differential calibration of the sensor.

The transducer of the barometric reference option senses atmospheric pressure via the reference port. When enabled, the port must be open to atmosphere.

The reference connection should be actively used (differential connection option) for precision low pressure measurement. The instrument measures pressure relative to the pressure at the reference port.

An atmospheric pressure change causes the indicator to adjust the displayed pressure. This appears as instability. To keep a stable displayed pressure, the reference port should be

## Chapter 6. Reference

---

restricted. Using a reference port restrictor (snubber), short term ambient pressure variations can be prevented from affecting indicator performance.

The indicator and UUT references should be connected together, using the optional differential connection kit, to provide a common reference to atmosphere.

### 6.3 Measure Setup

#### 6.3.1 Pressure Zero

During use, the instrument pressure sensor can show small zero shifts caused by time and temperature changes. Regular “zeroing” increases measuring precision.

#### 6.3.2 Process

Selects display processing features that change the reading, as follows:

Option	Description
%	Pressure can be displayed reading as a percentage of full-scale or as a percentage of a specified span.
Filter	The displayed reading can be filtered by a custom low pass filter or the filter can be disabled (default disabled). The indicator works at a speed independent of the filter time constant.
Tare	A specific tare value can be selected or the current displayed pressure reading can be “captured” as the tare value. The display shows the selected tare value in the pressure window.
Peak	Maximum, minimum and average display of pressure readings.

#### 6.3.3 Task

Selecting Task enables a set of pre-determined functions and software enabled optional functions.

#### 6.3.4 Units

Select the new units from the list of pressure measurement units. Special units can also be defined. Refer to Section 6.9.10, “User Defined Units,” on page 56.

#### 6.3.5 Global Setup

Refer to Section 6.8, “Global Setup,” on page 48.

#### 6.3.6 Setup Zero

Setup zero has the following configuration:

Option	Description
Mode	Off, Auto, Timed
Interval	00.00.00 (hours.minutes.seconds)
Isolation status	Isolated, Non-isolated

## 6.4 Control Setup

### 6.4.1 Vent

Select **Vent** to reduce the system pressure to near atmospheric pressure. Use this feature to reduce system pressure to a safe value before disconnecting the UUT. Use vent setup to adjust the slew rate of venting.

**Note:** The vent key can be selected in the control setup menu or programmed as an on-screen selection in the status area from the global setup/ display/status area menu.

### 6.4.2 Nudge

Sets the incremental resolution of the nudge control for trimming the set-point digits.

### 6.4.3 Set-point Limits

Defines the limits of pressure that can be entered as a set-point (used for protecting sensitive UUT).

### 6.4.4 Slew Rate

Sets how the controller achieves a set-point.

Option	Description
Max Rate	Set-point step changes to new set-point
Linear	Controller changing pressure linearly to set-point at a rate set by user.
Rate	Either maximum rate or at a rate (value) set by user.
Overshoot	Fast changing pressure may go beyond set-point.
No overshoot <sup>a</sup>	Changing pressure at an exponential rate but remaining within limits.

a. This function should be used for UUT that have hysteresis errors.

### 6.4.5 Control Mode

Selects one of the three modes that follows:

#### 6.4.6 Active Control

In this mode, the controller continuously maintains the set-point, compensating for small pressure leaks and thermal affects.

#### 6.4.7 Passive Control

In this mode, the user can define a band either side of the set-point, the default band equals to the instrument's precision. When the controlled pressure enters this band, the controller automatically shuts-off. If the measured pressure exits the band, the controller automatically re-establishes the pressure, without instability, the controlled pressure re-enters the band.

**Note:** If passive mode is in use with a leak free and thermally stable system then the control stability contribution can be discounted from the uncertainty calculation.

#### 6.4.8 Zero Gauge Control

The controller switches off once stable at zero gauge and the zero valve opened. Entering a new set-point causes the zero valve to close and the controller starts to control to the new set-point.

## 6.5 Global Setup

PIN protected menu. Refer to Section 6.9, "Supervisor Setup," on page 49.

### 6.6 Status

The display shows the following:

- a. Instrument status
  - Module 1 (Module 2 if fitted)
  - Control sensor
  - +ve source sensor
  - -ve source sensor
  - Barometric sensor (Optional)
- b. Software build - read only data
- c. Hardware build - read only data
- d. History - read only data
- e. Communications
- f. Current setup - read only data
- g. Use log - read only data
- h. Software options - read only data
- i. Summary - read only data.

### 6.7 Vent Setup

Use the vent setup to prevent damage to rate-sensitive equipment connected to this controller. The vent slew rate setting is independent of the controller slew rate settings.

### 6.8 Global Setup

#### 6.8.1 Supervisor Setup

PIN protected menu. Refer to Section 6.9, "Supervisor Setup," on page 49.

#### 6.8.2 Calibration

PIN protected menu. Refer to Section 6.9, "Supervisor Setup," on page 49.

#### 6.8.3 Save/Recall user setup.

- a. Save user setup.
- b. Recall user setup.

#### 6.8.4 Display

- a. Resolution
- b. Backlight
- c. Audio volume
- d. Status area.
- e. Screen mode (PACE 6000 only).

## 6.9 Supervisor Setup



**INFORMATION** A PIN protects the Supervisor menu against unauthorized use. Each instrument on delivery contains the factory set PIN (0268). To continue protecting the supervisor setup menu the PIN should be changed as soon as possible.

The Supervisor menu provides facilities for programming settings. These are made during installation as follows:

### 6.9.1 Protective Vent

The protective vent can be enabled or disabled and causes the discharge of pressure at a controlled rate if the measured pressure exceeds 110% full-scale. This protects the pressure sensor from over-range.

The Power-up trapped pressure vent can be enabled or disabled from the protective vent menu.

### 6.9.2 In-Limits

A tolerance value can be set at the set-point. When the controller achieves the set-point, the instrument controls within this set tolerance value. It does not affect controller stability or precision. The instrument uses the 'in-limits' flag when performing a control task such as Leak Test or Switch Test.

**Note:** In remote control, the control computer can be used to interrogate the 'in-limits' register to confirm the controller has achieved set-point.

### 6.9.3 Alarms

An alarm can be set to trigger when the pressure exceeds the high alarm or falls below the low alarm. A buzzer sounds when the alarm triggers and the alarm symbol (bell) appears on the display.

### 6.9.4 Communications

Selects a communication port parameter. Simultaneous operation of the RS-232, IEEE 488 and Ethernet interfaces is fitted as standard.

The user can select appropriate settings for communicating with the control computer (PC) and the required command protocol. Refer to K0472, SCPI Remote Communications Manual or K0469 Heritage Communications Manual.

#### 6.9.4.1 RS-232

Located on the rear panel an external RS-232 connection has the following configuration:

**Table 6-1: RS-232 Configuration Options**

Item	Description
Connector	9-way 'D' female. For pin connections, refer to Table 2-3 on page 14.
Communications	RS-232 point-to-point only. Daisy chain is not supported.
Baud Rate Power-up Default	9600, no parity, handshake = Xon/Xoff
Baud Rates Selectable <sup>a</sup>	2400, 4800, 9600, 19k2, 38k4, 57k6, 115k2
Parity	None, Odd, Even
Flow Control	None, Hardware, Xon/Xoff

## Chapter 6. Reference

**Table 6-1: RS-232 Configuration Options**

Item	Description
Protocols	SCPI
Heritage Emulation	DPI 500, DPI 510, DPI 515, DPI 520 <sup>b</sup>
Terminator	CR or LF or CR/LF

- a. Selectable through the user interface.
- b. Not all emulations are available on all models.

### 6.9.4.2 IEEE 488

Located on the rear panel an external IEEE 488 connection has the following configuration:

**Table 6-2: IEEE 488 Configuration Options**

Item	Description
Connector	24-way 'D' female wired as IEEE 488 standard.
Communications	IEEE 488 GPIB
Default Address	16
Protocols	SCPI
Heritage Emulation	DPI 500, DPI 510, DPI 515, DPI 520 <sup>a</sup>

- a. Not all emulations are available on all models.

### 6.9.4.3 Ethernet

Located on the rear panel an external Ethernet connection has the following configuration:

**Table 6-3: Ethernet Configuration Options**

Item	Description
Connector	Ethernet RJ45
Protocol	SCPI
Terminator	CR/LF
Default Address	Auto IP (0.0.0.0)
Host name	PACExxxxxx (where xxxxxx = serial number)
Web Password	0268
Access Control	Open
Reset LAN Settings	Selected in Supervisor setup menu

A firewall protects the Ethernet connection. The firewall is always turned on. Table 6-4 details the PACE open Ethernet ports.

**Table 6-4: Open Ethernet Ports**

Ethernet Port	Use
80/tcp	PACE Web server (http).
111/tcp	rpcbind (RPC for VXI).
111/udp	rpcbind (RPC for VXI).



**Table 6-4: Open Ethernet Ports**

Ethernet Port	Use
443/tcp	PACE Web server (https).
5025/tcp	SCPI communication socket.
****/tcp	VXI-11 communication (dynamically allocated).

The Ethernet connection provides the following functionality:

- PACE Ethernet supports both VXI-II and Sockets automatically.
- Socket port address 5025.
- Internet protocol IP4.

To configure the Ethernet connection:

1. Touch any of the three horizontal Measure touch pads on the home screen to open the CONTROL SETUP screen
2. On the CONTROL SETUP screen, select GLOBAL SETUP.

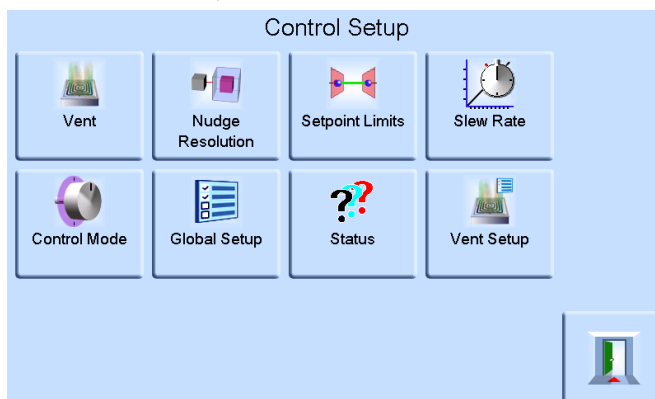

3. Select SUPERVISOR SETUP.

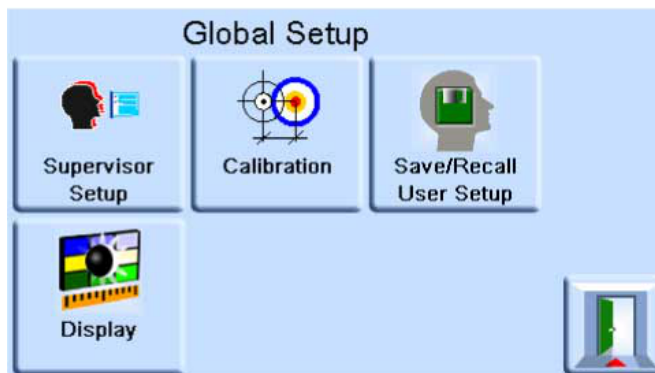

## Chapter 6. Reference

4. Enter the Supervisor PIN and press ENTER SUPERVISOR PIN. Use the back arrow in the top right corner of the screen to delete any incorrect data entries.



**Note:** The factory set Supervisor PIN is 0268. If the Supervisor PIN has been locally changed, make sure that the new PIN is kept in a safe place. If the new PIN is lost, it can only be reset at a Druck Service Centre.

5. Press COMMUNICATIONS STATUS to open the COMMUNICATIONS STATUS screen.

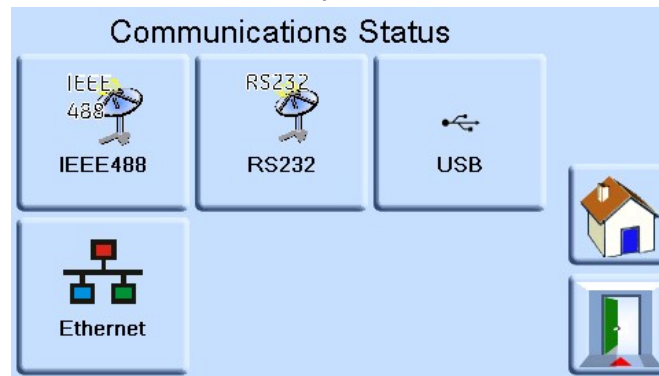

6. Select ETHERNET to open the ETHERNET PARAMETER screen.

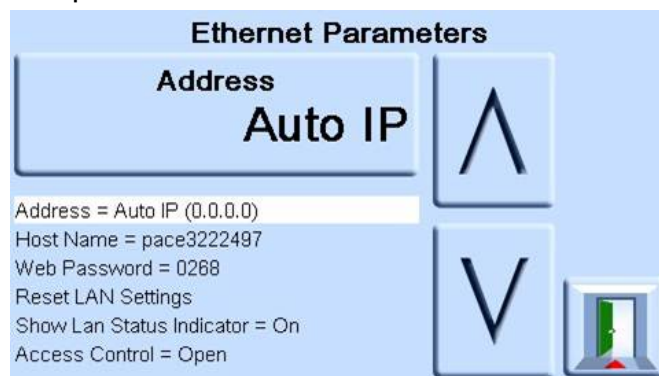

7. To change the ADDRESS parameter, complete the following:
  - a. On the ETHERNET PARAMETER screen, use the UP and DOWN arrows to highlight the ADDRESS field.

- b. Press the top touch pad on the screen to enter the ADDRESS TYPE screen.

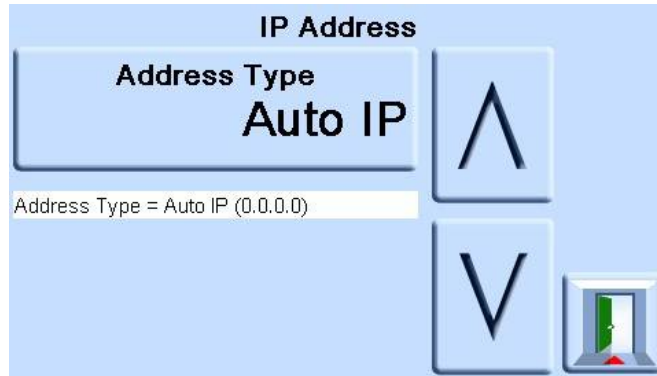

- c. Use the UP and Down arrows to highlight the desired address type (either AUTO IP or STATIC).

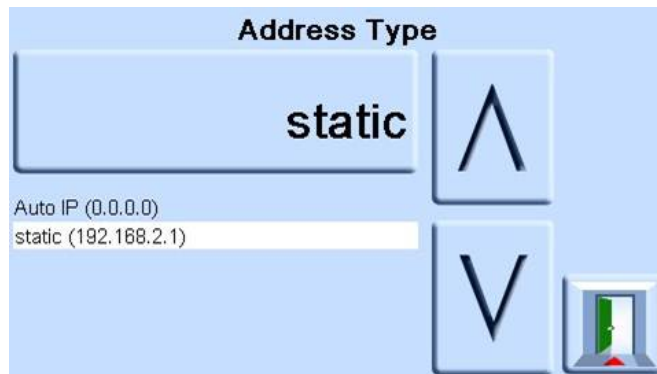

- d. Press the top touch pad on the screen to set the new address type. The screen automatically returns to the ETHERNET PARAMETERS screen.

8. To change the host name, complete the following:

- a. On the ETHERNET PARAMETER screen, use the UP and DOWN arrows on the right of the screen to highlight the HOST NAME field.

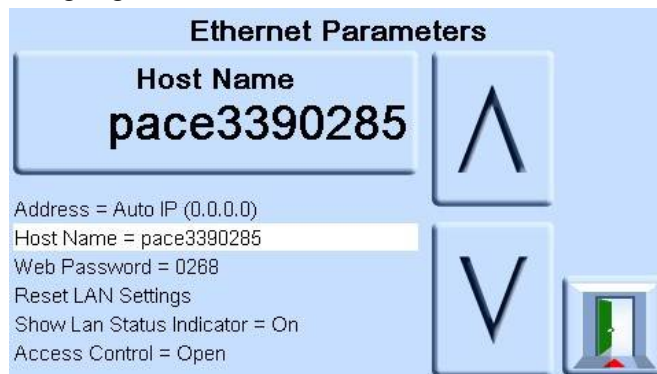

- b. Press the top touch pad on the screen to enter the HOST NAME screen.

## Chapter 6. Reference

- c. Use the keyboard to input the new host name and then press the top button on the screen to set the host name. The screen automatically returns to the ETHERNET PARAMETERS screen.



9. To change the web password, complete the following:
  - a. On the ETHERNET PARAMETER screen, use the UP and DOWN arrows on the right of the screen to highlight the WEB PASWORD field.

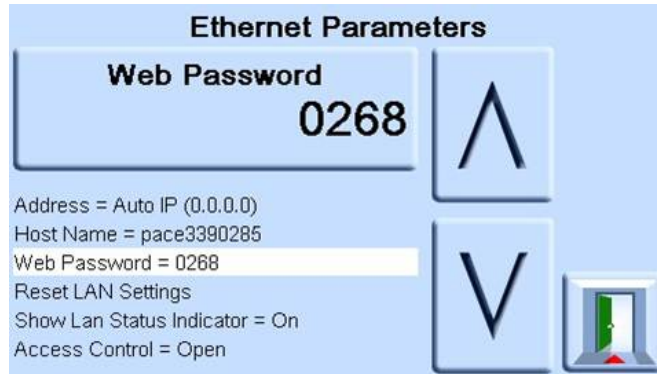

- b. Press the top touch pad on the screen to enter the WEB PASSWORD screen. The keyboard screen opens.



- c. Use the keyboard to input the new web password and then press the top touch area on the screen to set the new password. The screen automatically returns to the ETHERNET PARAMETERS screen.

10. To reset the LAN settings, complete the following:
  - a. On the ETHERNET PARAMETER screen, use the UP and DOWN arrows on the right of the screen to highlight the RESET LAN SETTINGS field.
  - b. Press the RESET THE LAN SETTINGS touch pad on the top touch pad of the screen.

- c. The RESET LAN SETTINGS sub-screen asking for confirmation of the reset. Press YES to confirm reset of the LAN settings.

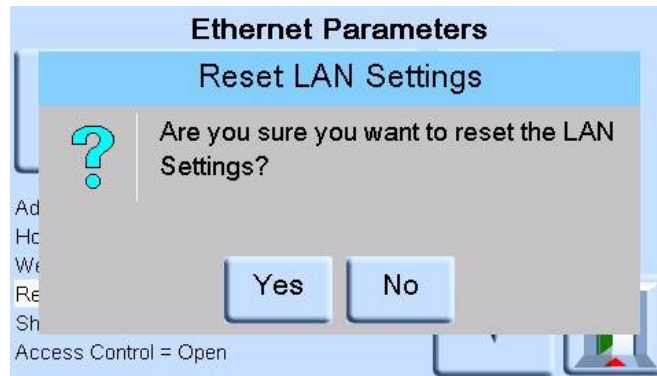

- 11. To turn the LAN status indicator on or off, complete the following:
  - a. On the ETHERNET PARAMETER screen, use the UP and DOWN arrows on the right of the screen to highlight the SHOW LAN STATUS field.

### 6.9.4.4 USB

Located on the rear panel an external USB 'B' connection has the following configuration:

**Table 6-5: USB 'B' Configuration Options**

Item	Description
Communications Mode	Mass Storage Device or Communications
Protocols	SCPI
Terminator	CR or LF or CR/LF

Communications mode is selected for serial communications using the SCPI protocol.

Mass storage device is selected to mount an external USB 'A' connected mass storage device or the internal memory SD card, from a PC connected to the USB 'B' port. When connecting a mass storage device into the USB 'A' connector, the internal memory SD card becomes inaccessible.

**Note:** When upgrading software, make sure that the USB 'B' connection is disconnected.

To configure the USB connection:

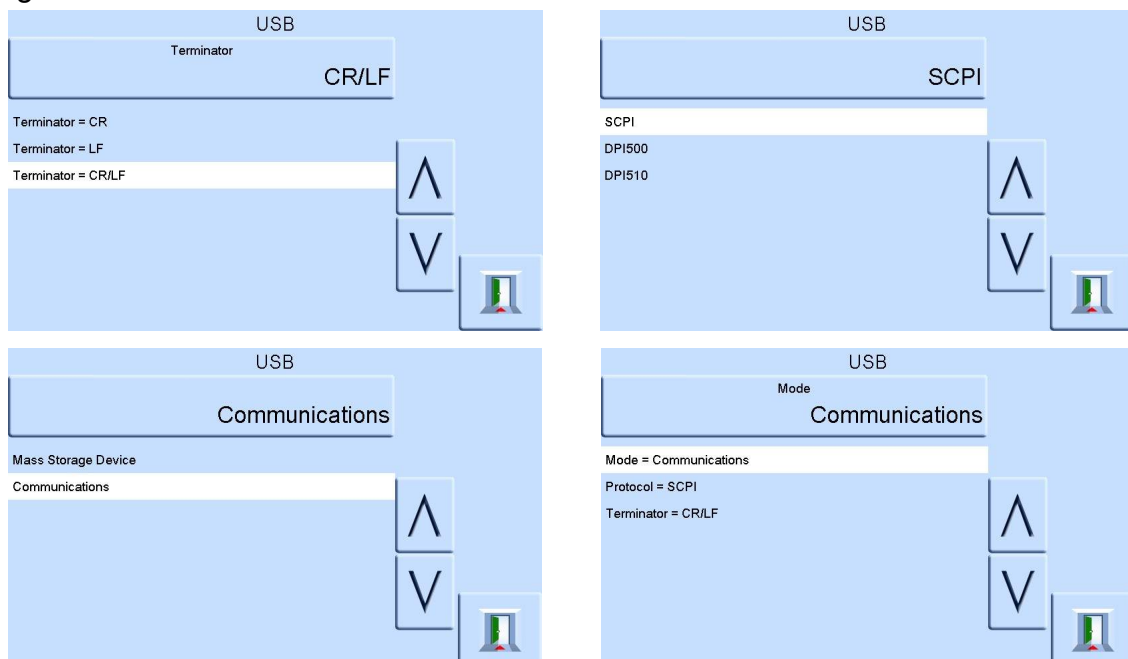

## Chapter 6. Reference

### 6.9.5 Timeout

Presets the times for automatically changing from control to measure mode.

**Note:** Controller timeouts can save supply gas, extending control valve life and minimizing acoustic noise.

### 6.9.6 Idle Timeout

Starts when the controller achieves the set-point after the set time, if new set-points are not entered the timer will time-out and return to measure mode.

### 6.9.7 Gas Head Correction

Corrects pressure reading for the height difference between instrument reference level and UUT. For accuracy, head correction must be enabled and the parameters set for each sensor.

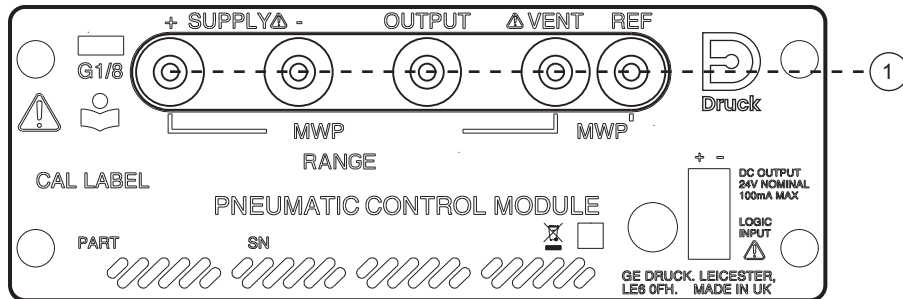

1 Reference level.

- For UUT positioned higher than the reference level of the PACE, enter a positive height correction.
- For UUT positioned lower than the reference level of the PACE, enter a negative height correction.
- When calibrating the PACE instrument disable the gas head correction and correct the actual applied pressures for height.

### 6.9.8 Lock Tasks

#### 6.9.8.1 Individual Tasks

Allows any combination of individual tasks to be disabled.

**Note:** Restricts operation of the instrument to specific tasks or functions, recommended for production procedures.

#### 6.9.8.2 All

Disables all tasks.

### 6.9.9 Change PIN

Changes the Supervisor PIN: enter the existing PIN, then the new PIN and confirmation of the new PIN.

**Note:** Confirmation of the new PIN permanently replaces the old PIN. Record this new PIN and keep in a safe place. If new PIN is lost it can only be reset by returning the instrument to a Druck service center.

### 6.9.10 User Defined Units

Permits the user to define a set of units. Following the on-screen prompts special units may be set by selecting a Pascal multiplier and assigning a five character name.

### 6.9.11 Instrument Alias Name

Permits the user to define a 20 character alias name for the instrument. The instrument returns this name through the communications interfaces.

### 6.9.12 Language

Operation in any of the following languages can be selected:

- English (default)
- French
- German
- Italian
- Portuguese
- Spanish
- Russian
- Chinese
- Japanese

More languages can be added.

#### 6.9.12.1 Adding a Language

Languages can be added as follows. Refer to Figure 6-1.

1. Create a language file by translating from the English language file.
2. Check the pixel width of each translated word by using the PACE language check file. This can be downloaded from the Druck Support Central.
3. Create an empty DPI folder on a USB stick.
4. Create an empty "LANGUAGES" sub-folder.
5. The language file naming conventions is "Language<<language name>>.Ing".
6. Save the language file into the languages sub-folder.
7. Use the PACE instrument software upgrade procedure to upload the language file from the USB stick into the PACE instrument.



## Chapter 6. Reference

**Note:** An English and French language file name would be: LanguageEnglish.Ing and LanguageFrench.Ing. Language files named “Language.Ing” or in any other format will be ignored by PACE.

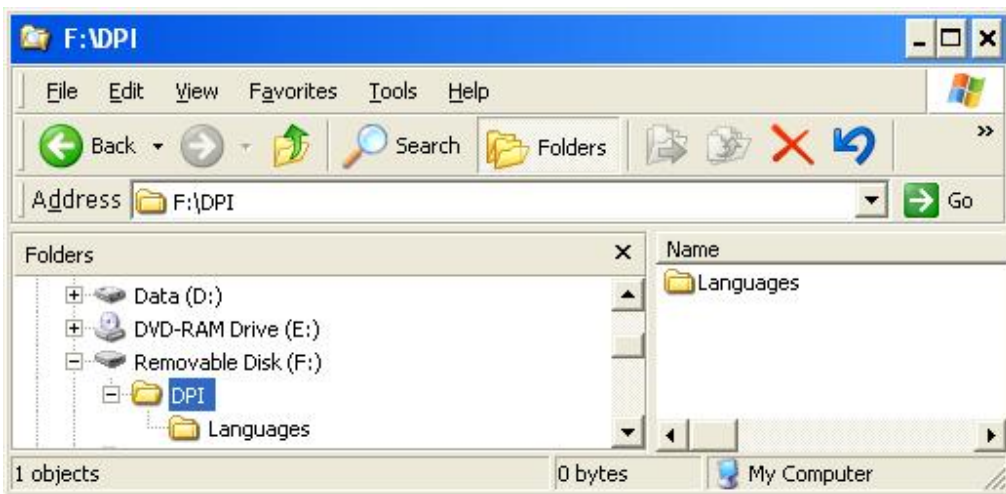
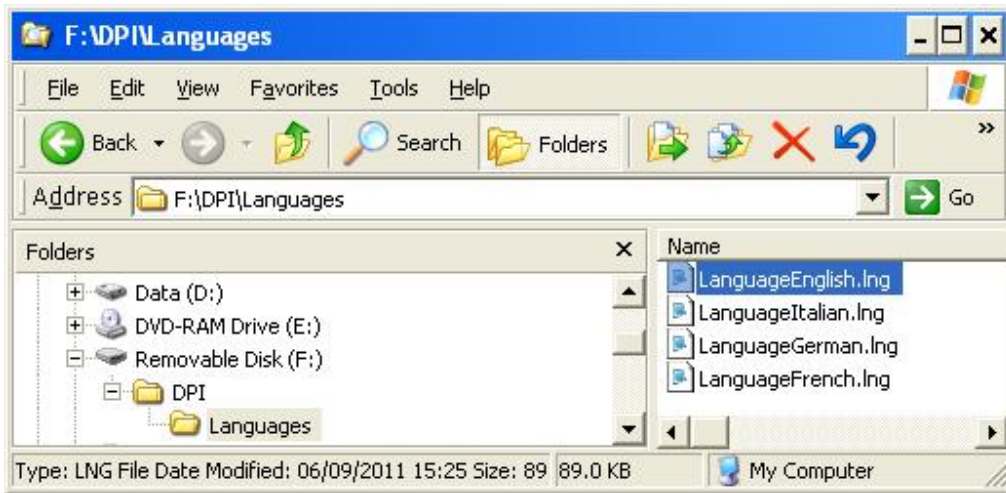

**Figure 6-1: Language Setting**

### 6.9.13 Restore as Shipped Settings

Restores instrument settings to factory default.

**Note:** Does not affect PIN settings.

## 6.10 Option Enable Process

To enable soft options on a PACE instrument, use the following:

1. Touch the top Measure area of the screen.
2. Select Global Setup.
3. Select Calibration.
4. Enter a Calibration PIN 1234.
5. Enter new option key xxxxxxxxxx (10 digits).
6. After entry of this key PACE confirms the options have been enabled.



## 6.11 Leak Test Option

This task applies one or two test pressures to either an external system to find any leaks in a system connected to the instrument or an internal leak check. This task sets the test pressure, control dwell time at the test pressure and the leak test time (measure dwell time).

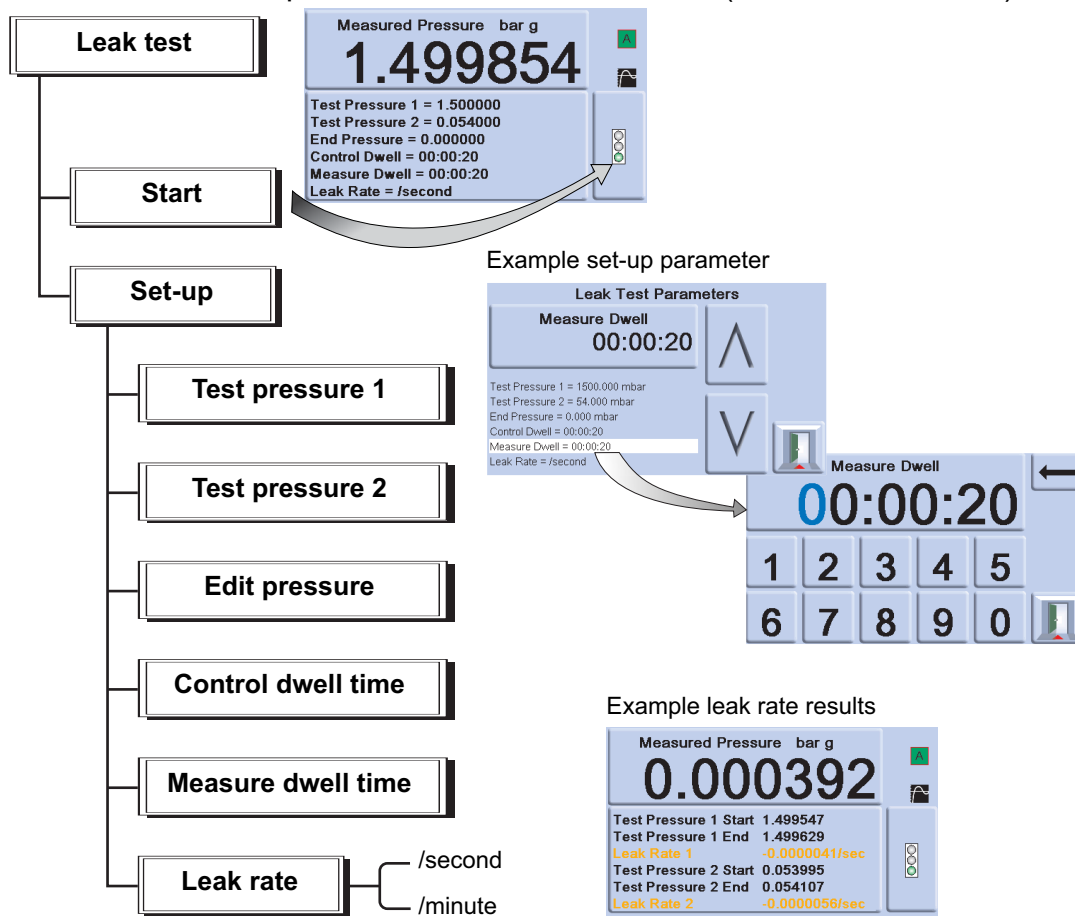

**Note:** If only one test pressure is required, set TP1 = TP2.

At the start of the test, the instrument applies a test pressure to the user system.

A control dwell time allows the user system to thermally stabilize. The instrument changes to measured mode and then records the pressure change during measure dwell time. On

## Chapter 6. Reference

completion, the display shows the leak rate results with leak rates per second or per minute in the current pressure units selected in measure setup.

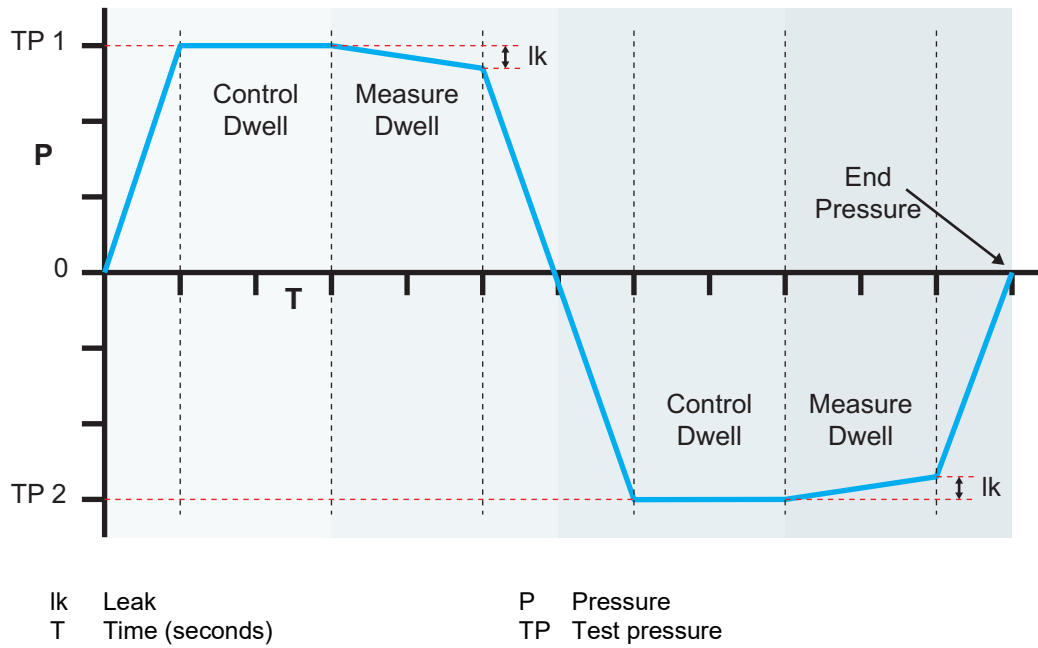

## 6.12 Switch Test Option

This function automates the testing of pressure switch devices. Connect the pressure port of the switch to be tested to the output port. Connect the switch contacts in series with the 24 V dc output and the Logic input.

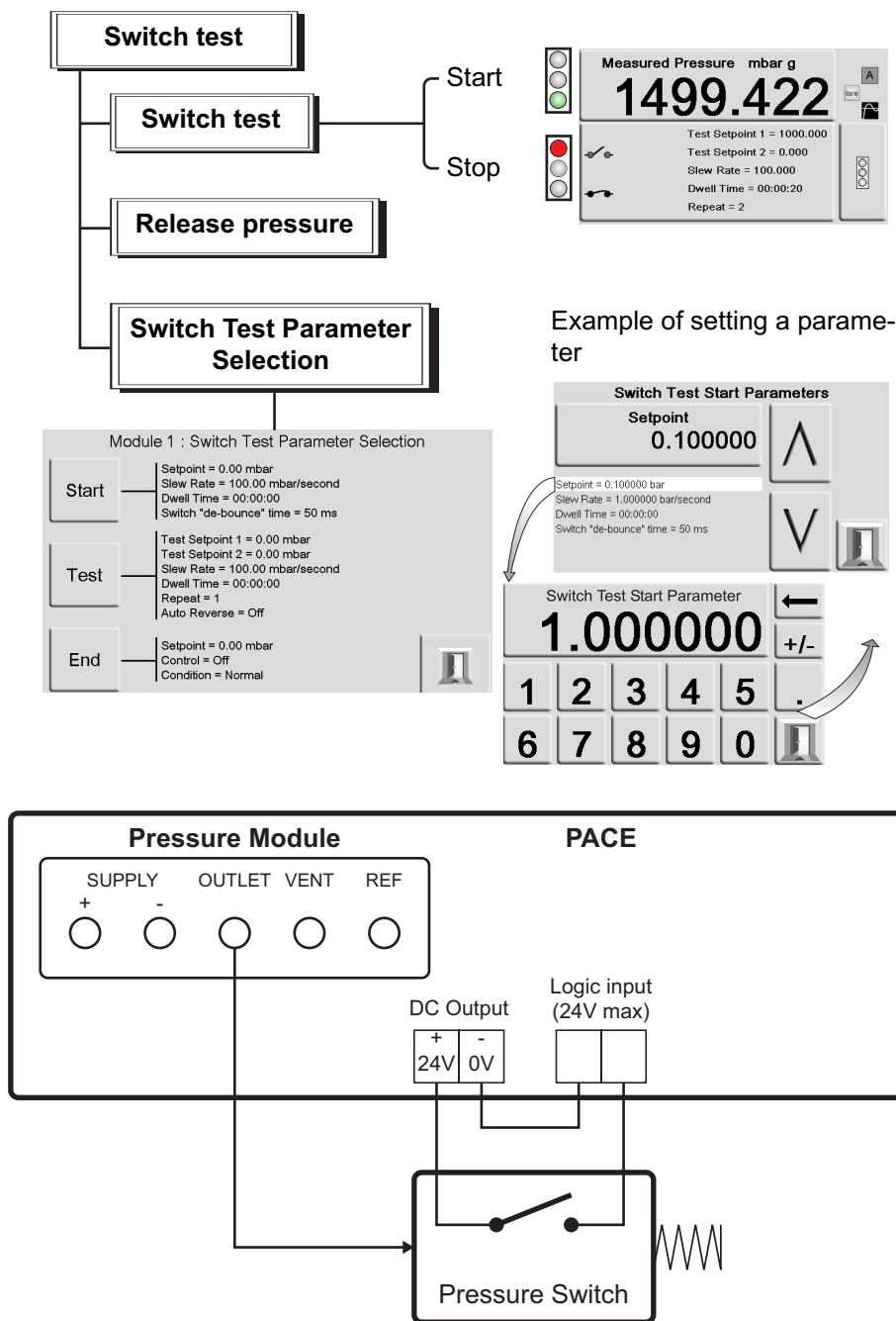

**Figure 6-2: Example Switch Test Connections**

**Note:** The volt-free logic input connections require a switching potential (24 V max) to be applied. If necessary, this can be an external DC source. Common mode must be kept within 30 V maximum.

### 6.12.1 Start

Controls pressure at a fast slew rate to a set-point just below expected switch operating point. De-bounce time can be increased for slower test slew rates.

# Chapter 6. Reference

## 6.12.2 Test

Controls pressure between two set-points and can repeat (loop). Auto-reverse can be selected.

## 6.12.3 End

Controls pressure to a safe condition to disconnect switch under test.

## 6.12.4 Procedure

Select the switch test parameters in the switch test menu, including the start pressure, end pressure and test rate of change. Slower rates give more accurate results. The de-bounce time can be set between 0 and 200 ms.

After the test, the display shows the pressures at which the contacts open and close and the switch hysteresis (the difference between the two switching pressures).

Before disconnecting the switch under test, press **Release pressure** to release any residual pressure.

**Note:** This switch test procedure can be repeated to “exercise” the switch unit.

Logic input is opto-isolated. An external supply (5V to 24 V dc) can be used provided its' common mode voltage remains with 30V max with respect to chassis.



## 6.13 Test Program Option

The test program task provides a facility for writing and executing test procedures. Selecting a test program from the Task menu displays all the task programs currently stored, together with the ability to write new ones.

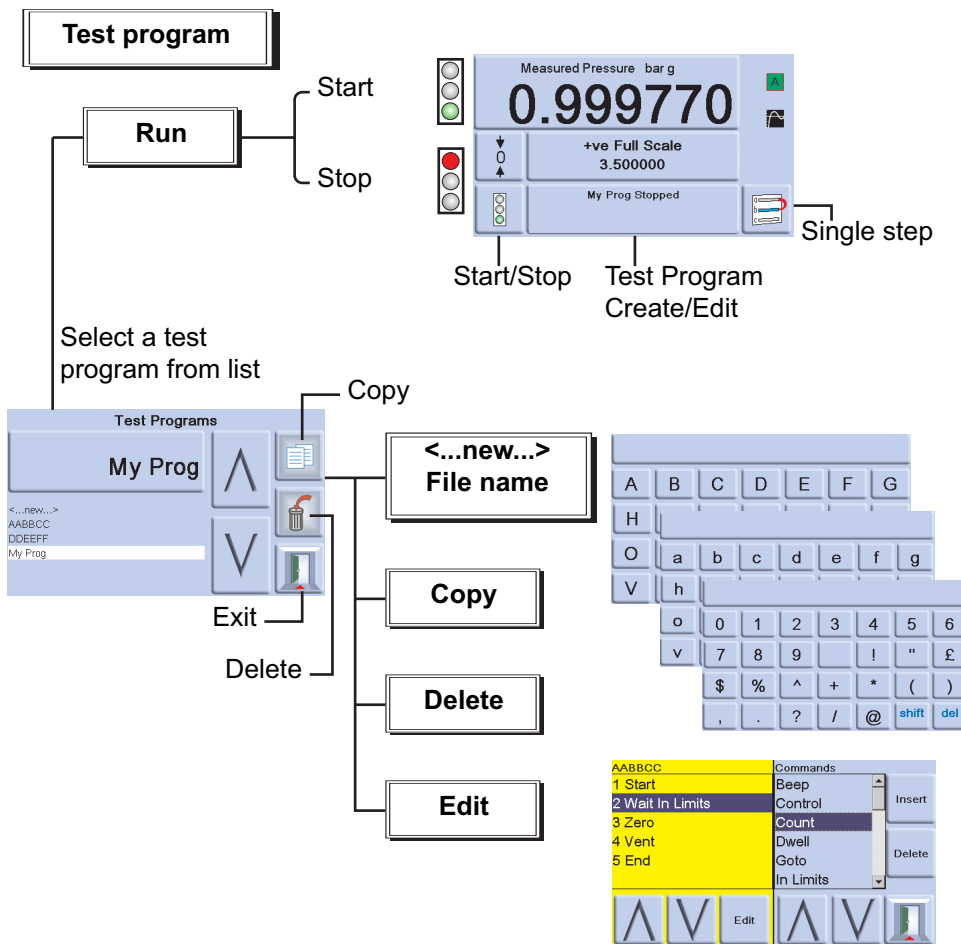

### 6.13.1 Creating a Test Program

1. Select the Test Program Create/Edit key.
2. Select New.
3. To enter a name for the program do the following:
  - a. Use the text editor keys to create the Test program name.
  - b. Press enter on completion.

**Note:** A new test always contains a START and END command (first and last line instructions), these lines cannot be deleted.

### 6.13.2 Editing an Existing Test Program

1. Select the Test Program Create/Edit key.
2. Select the test program by name.
3. The display shows the test program to the left and available commands, that can be inserted, to the right.
4. To delete a command within a test program, select the command using the up/down arrow keys and then press the delete key.
5. To edit a command parameter within a test program, select the command using the up/down arrow keys and then press edit.
6. To save a created or edited test program, select the exit key, then select “Yes” to save and exit. “No” will exit the test program without saving any changes. “Cancel” will return you to the test program edit screen.

### 6.13.3 Running a Test Program

1. Select the Test Program Create/Edit key.
2. Select the test program listed on the screen then press Exit.
3. To start a test program, press Start.
4. When the program starts, a stop legend replaces the run legend.
5. Press the stop key at any time to stop the test program.

### 6.13.4 Copying a Test Program

This function allows you to make a copy of an existing Test program file to this instrument and rename it, copy files to a USB memory device and copy files from a USB memory device.

1. Press the Copy function button. Three options become available.
2. Select the desired option and follow the on-screen prompts.

**Table 6-6: Test Program Commands**

Command	Description
BEEP	Sounds a beep (on/off).
BREAK	Breaks to this point when stop count command or STOP icon is selected, then executes the code from the break statement to the end statement.
CONTROL	Selects Control mode.
COUNT 1	Counter 1 - Used in a loop to count the number of loop cycles. (Legacy count).
COUNT 2	Counter 2 - Used in a loop to count the number of loop cycles.
DWELL	Specifies dwell time (seconds) within the test program.

## Chapter 6. Reference

**Table 6-6: Test Program Commands**

<b>Command</b>	<b>Description</b>
GOTO	Used to setup a loop. Enter program line number to go to.
IF	If statement allows for a decision. For instance, if count 1 = 5 then GOTO xx
IN LIMITS	In-Limits band setting (% full-scale).
IN LIMITS TIMER	Waits, within In-limits for this time period, before setting a valid In-limits condition and continuing the Test program sequence.
I/P LOGIC	Specifies change of state for external contacts as a halt condition.
ISOLATION VALVE	Control of output isolation valve: Isolated (closed) or Non-isolated (open).
MEASURE	Selects Measure mode.
PAUSE	Causes test program to pause and wait for user input (Resume).
RANGE	Specifies instrument range. Test program can only run within one control module.
RATE MAX	Sets controller rate to maximum.
RATE VALUE	Specifies controller linear rate entered., per minute or second
RESOLUTION	Sets display resolution.
SET COUNT 1	Sets the counter 1 internal value.
SET COUNT 2	Sets the counter 2 internal value.
SETPOINT	Allows set-point to be entered.
SETTLING FAST	Used to specify controller fastest response, may overshoot.
SETTLING NO OVERTHOOT	Used to specify controller response without overshoot.
STOP COUNT	Used to stop loop program after a number of loops. (Legacy support only, not recommended for use if count 1 and count 2 are listed).
TEXT	Sets screen message.
UNITS	Selects required display units.
VENT	Instructs the module to vent.
VFC OFF	Sets VFC allocation test program off. (Legacy support only, not recommended for use if select VFC relay command is present).
VFC ON	Sets VFC allocation test program on. (Legacy support only, not recommended for use if select VFC relay command is present).
SELECT VFC RELAY 1	Allows control of VFC 1: R1, R2, R3 (When VFC is set to Test program under VFC setup).
SELECT VFC RELAY 2	Allows control of VFC 2: R1, R2, R3 (When VFC is set to Test program under VFC setup).
WAIT IN-LIMITS	Waits until pressure is within the limits.
ZERO	Output zeroed

When selected, certain commands require a value or selection to be set (e.g.) RANGE, RATE, TEXT the display shows a screen prompt for the appropriate setting.

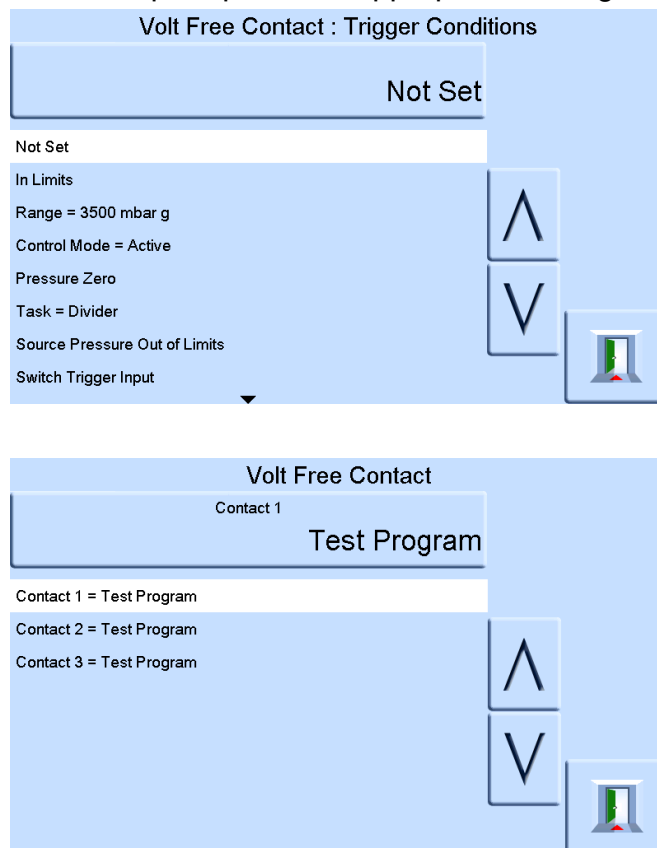

## 6.13.5 Example Program

**Note:** Changes to instrument settings made in a test program remain valid only for the test program.

The second step of a test program must contain the units command.

The instrument reverts to the pre-test settings on exit to another task.

**Table 6-7: Example Program**

Step	Command	Argument	Action
1	START		Program start
2	UNITS	mbar	Select units, mbar
3	RATE	100	Select rate, 100 mbar/min
4	IN LIMITS TIME		10 (00:00:10) seconds
5	IN LIMITS		Set In-Limits band
6	RESOLUTION	5	Display resolution, 5 digits
7	SETTLING		No overshoot
8	TEXT		Operator instruction, e.g."Connect UUT"
9	ZERO		
10	SET POINT	400	Set-point, 400 mbar
11	CONTROL		Controller ON
12	WAIT IN LIMITS		Wait for In-Limits condition

**Table 6-7: Example Program**

Step	Command	Argument	Action
13	BEEP		Beep on, approximately 1 second, Beep off
14	MEASURE		Switch to Measure mode (controller off)
15	DWELL	30	Wait for 30 seconds (00:00:30)
16	SET POINT	800	Set-point, 800 mbar
17	CONTROL		Controller on
18	WAIT IN LIMITS		Wait for In-Limits condition
19	BEEP ON		Beep on, approximately 1 second, Beep off
20	MEASURE		Switch to Measure mode (controller off)
21	TEXT		Operator instruction, e.g. (Wait for beep, record pressure)
22	DWELL	30	Wait for 30 seconds
23	BEEP		Beep on, approximately 1 second, Beep off
24	TEXT		Operator instruction, e.g. "Min pressure allowed 785 mbar"
25	PAUSE		WAIT (for operator input to touch single step)
26	VENT		Vent
27	END		Program end

### 6.13.6 Programming Loops

To program a loop, use the GOTO command.

Include the COUNT command in the loop for counting the number of loop cycles.

**Note:** The test program commands do not include tests for conditional jumps.

The second step of a test program must contain the units command.

To stop a test program from looping, STOP must be selected by the operator.

**Table 6-8: Example of Programming a Loop**

Step	Command	Argument	Action
1	START		Program start
2	UNITS	mbar	Select units, mbar
3	RATE VALUE	100	Select rate 100 mbar/min
4	RESOLUTION	5	Display resolution, 5 digits
5	IN LIMITS		Sets the In-Limits band
6	IN LIMITS TIME		10 (00:00:10) seconds
7	SETTLING NO OVERSHOOT		No overshoot
8	TEXT		Operator instruction, e.g. "Connect UUT"
9	ZERO		Performs a sensor zero
10	SET POINT	400	Set-point, 400 mbar



Table 6-8: Example of Programming a Loop

Step	Command	Argument	Action
11	CONTROL		Controller ON
12	WAIT IN LIMITS		Wait for In-Limits condition
13	BEEP ON		Beep on, approximately 1 second, Beep off
14	MEASURE		Switch to measure (controller off)
15	DWELL	30	Wait, 30 seconds
16	SET POINT	800	Set-point, 800 mbar
17	CONTROL		Controller on
18	WAIT IN LIMITS		Wait for In-limits condition
19	BEEP ON		Beep on, approximately 1 second, Beep off
20	MEASURE		Switch to measure, controller off
21	COUNT 1		Increment loop counter
22	VENT		Vent
23	GOTO	9	Loop back to program line 9
24	BREAK		
25	SET POINT	0	
26	WAIT IN LIMITS		
27	MEASURE		
28	END		Program end

## 6.14 Barometric Reference Option

The barometric reference option measures the barometric pressure at the reference port.

When installed, this option allows absolute or gauge pressure range selection. To obtain absolute pressure the instrument uses a summation of gauge pressure and barometric pressure (measured by the barometric sensor).

# Chapter 6. Reference

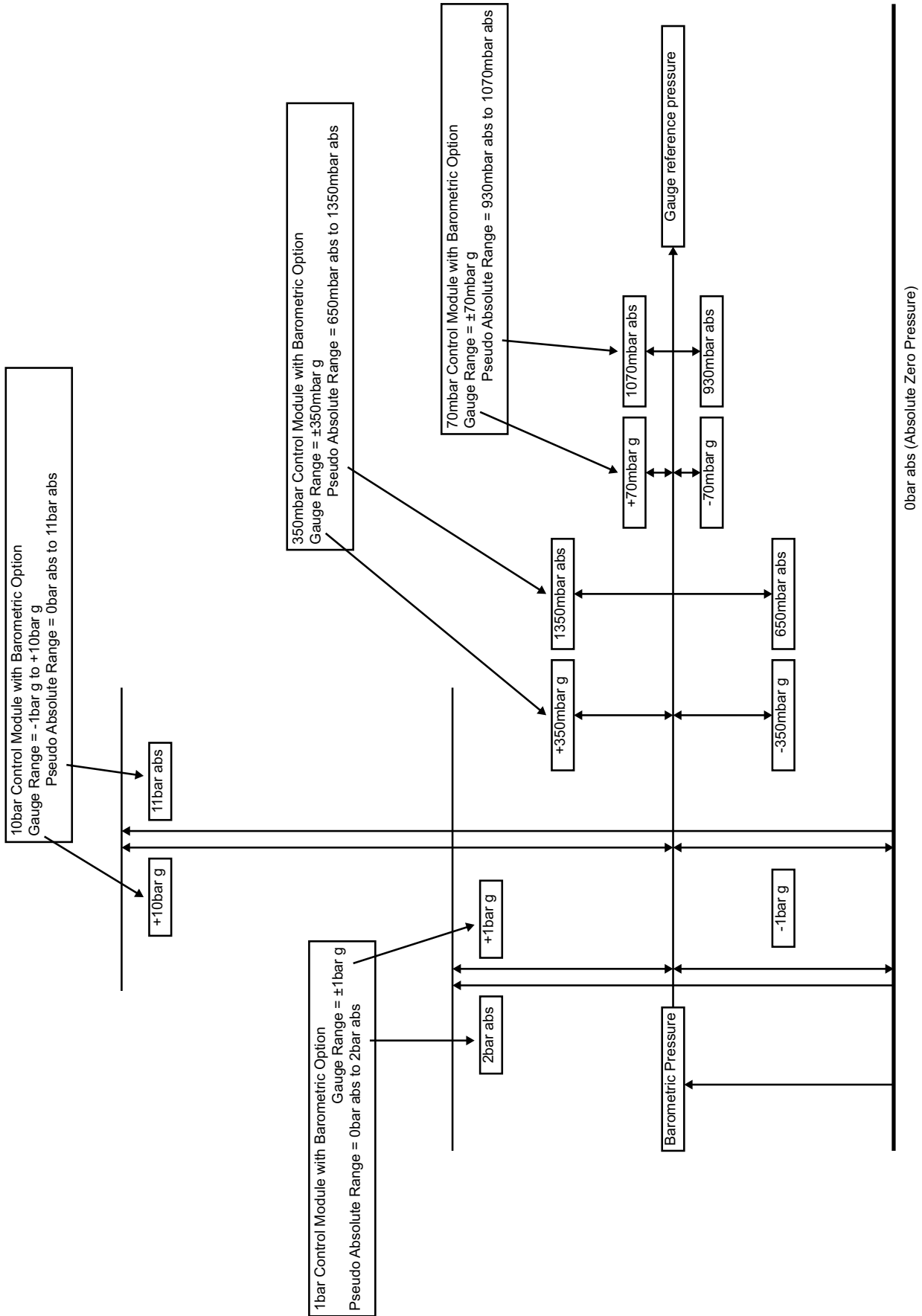

### 6.14.1 Zeroing the Reference Sensor



**INFORMATION** To prevent damage to the instrument, the VENT and REF ports of the pneumatic control module shall be open to the atmosphere during a Pressure Zero.

If a CM3 module is present, there is the option to zero the reference sensor using the barometer sensor reading.

To zero the reference sensor:

1. On the MEASURE SETUP or CONTROL SETUP screen, select GLOBAL SETUP.

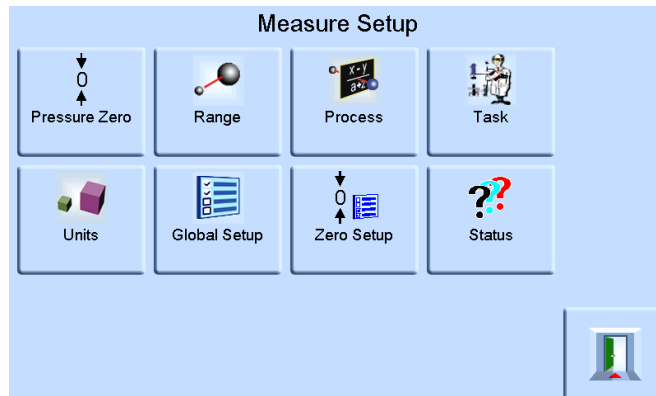

2. On the GLOBAL SETUP screen, select CALIBRATION.

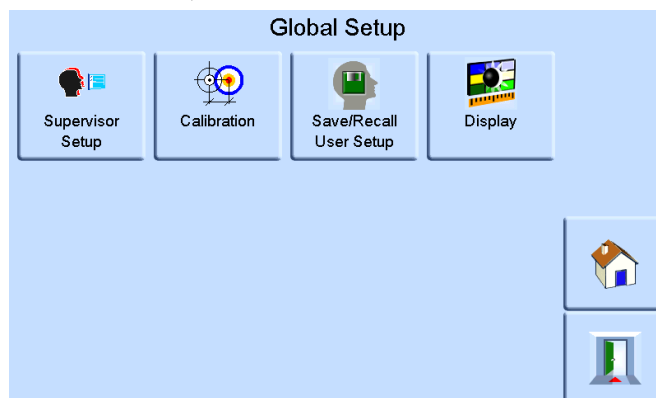

3. Enter the Calibration PIN and press ENTER CALIBRATION PIN. Use the back arrow in the top right corner of the screen to delete any incorrect data entries.

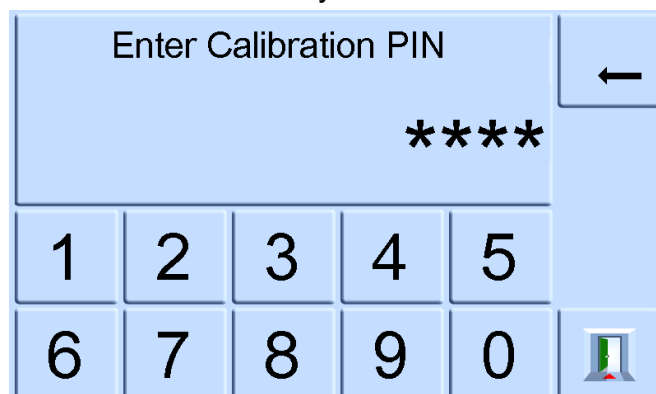

**Note:** The factory set Calibration PIN is 4321.

## Chapter 6. Reference

4. On the CALIBRATION screen, select SENSOR CORRECTION.

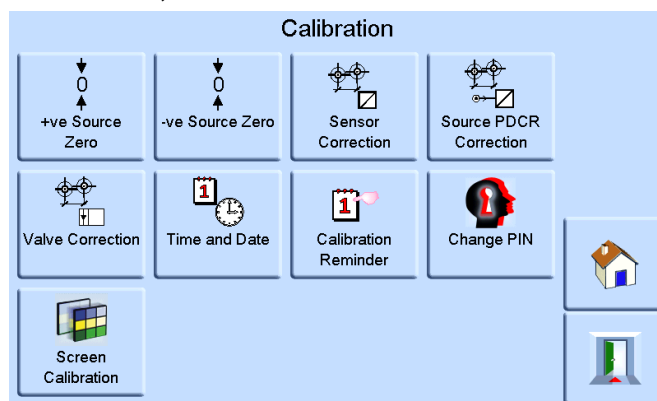

**Note:** If the instrument was in Control mode prior to entering the CALIBRATION menu, the instrument will go into Measure mode.

5. In the SENSOR CORRECTION screen, select REFERENCE SENSOR.

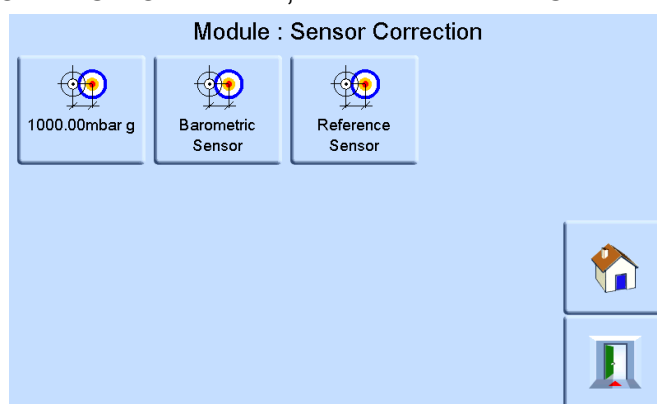

6. In the CALIBRATING REFERENCE SENSOR screen, select PRESSURE ZERO and press YES to confirm.

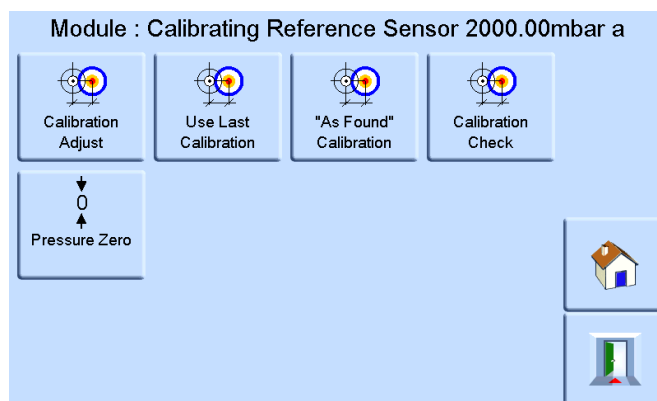

The vent valve in the instrument will now open. This allows the pressure within the manifold to stabilize to atmospheric pressure. A pressure zero is calculated using the difference between the reference sensor and barometric readings. A pressure zero is only accepted under the following condition:

Reference Sensor reading (vented) – Barometric Sensor reading  $\leq \pm 2000$  ppm FS (0.2% FS)

If this condition is not met, the following ZERO OUTSIDE LIMITS error is shown.

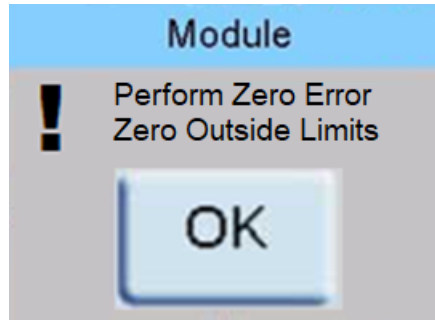

**Note:** A zero outside limits error may indicate that the reference sensor is faulty. Contact a Druck Service Centre for assistance.

Refer to Data Sheet for the barometric reference and precision of absolute ranges.

## 6.15 Aeronautical Option

The aeronautical option is a specialized application of the PACE instrument.

**Note:** The PACE instrument must be setup very carefully so that the aeronautical pressures applied do not exceed maximum pressure values and rates of change.

### 6.15.1 Leak Testing



**CAUTION** Do not exceed the maximum pressures stated in the appropriate component maintenance manual for the unit under test.

Carefully de-pressurize all pipes (tubes) to atmospheric pressure before disconnecting and connecting to the unit under test.

Before testing an aeronautical component do a leak test.

This task sets the test pressure, dwell time at the test pressure and the leak test time.

At the start of the test, the instrument applies a test pressure to the user system.

A dwell time allows the user system to stabilize.

### 6.15.2 Aeronautical Testing

The aeronautical task enables control and measurement of the following:

- Altitude (feet/metres)
- Airspeed (knots, mph, km/h)

This task utilizes dual pressure displays to show the parameter and the rate of change of the following:

- Altitude
- Airspeed
- Mach and Airspeed with Mach number

The aeronautical task enables the testing and calibration checking of aeronautical indicators and system components by controlling and displaying values and rates in aeronautical units.

# Chapter 6. Reference

When using a single instrument, the pressure supply must be changed when changing from Altitude to Airspeed.

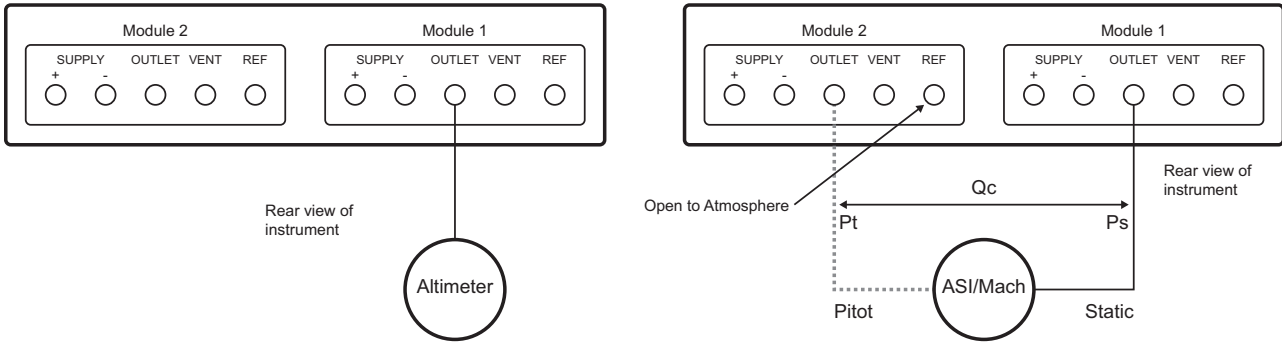

### 6.15.3 Example of Altitude and Airspeed Testing

This example shows how two-channel PACE instruments can be used to generate altitude and airspeed.



**CAUTION** Before testing, set the rates of change for both pitot and static to a safe value. A high rate of change can damage sensitive aeronautical components. Refer to the appropriate component maintenance manual for the unit under test.

In this example configuration, negative airspeed can be generated this can damage an airspeed indicator. To prevent negative airspeed, apply the static pressure before the pitot pressure for increasing and decreasing airspeed values.

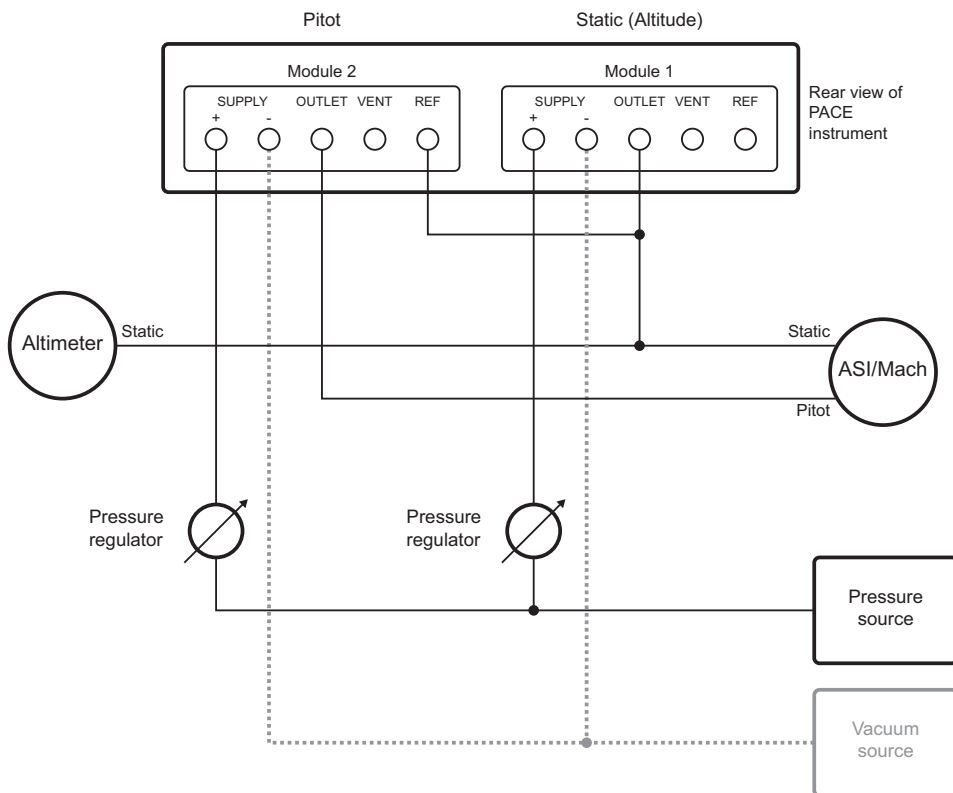

### 6.15.4 Units

The units can be either the aeronautical or pressure units. The units can be changed any time between pressure and pressure converted to aeronautical units. The display shows the output

pressure converted to Altitude, CAS or Mach using BS 2G 199:1984\* conversions and assuming standard atmospheric conditions.

### 6.15.5 Reference Pressure

Select the required reference pressure, this can be either the barometric pressure (from the instrument's internal barometric sensor), or any numeric value (e.g.) 1013.25 mbar.

**Table 6-9: Airfield Task Q Codes**

Q Code	Description
QFE	Atmospheric pressure at sea level, corrected for temperature and adjusted to airfield elevation. When set on the altimeter it reads height.
QNE	Atmospheric pressure at Sea level in International Standard Atmosphere (ISA) 1013.25 mbar.
QFF	Barometric pressure at a place, reduced to Mean Sea Level (MSL) using the actual temperature at time of observation as mean temperature.
QNH	Atmospheric pressure at Mean Sea Level (MSL) (may be local, measured pressure or a Regional Forecast Pressure (RFP)). When set on altimeter it reads altitude.

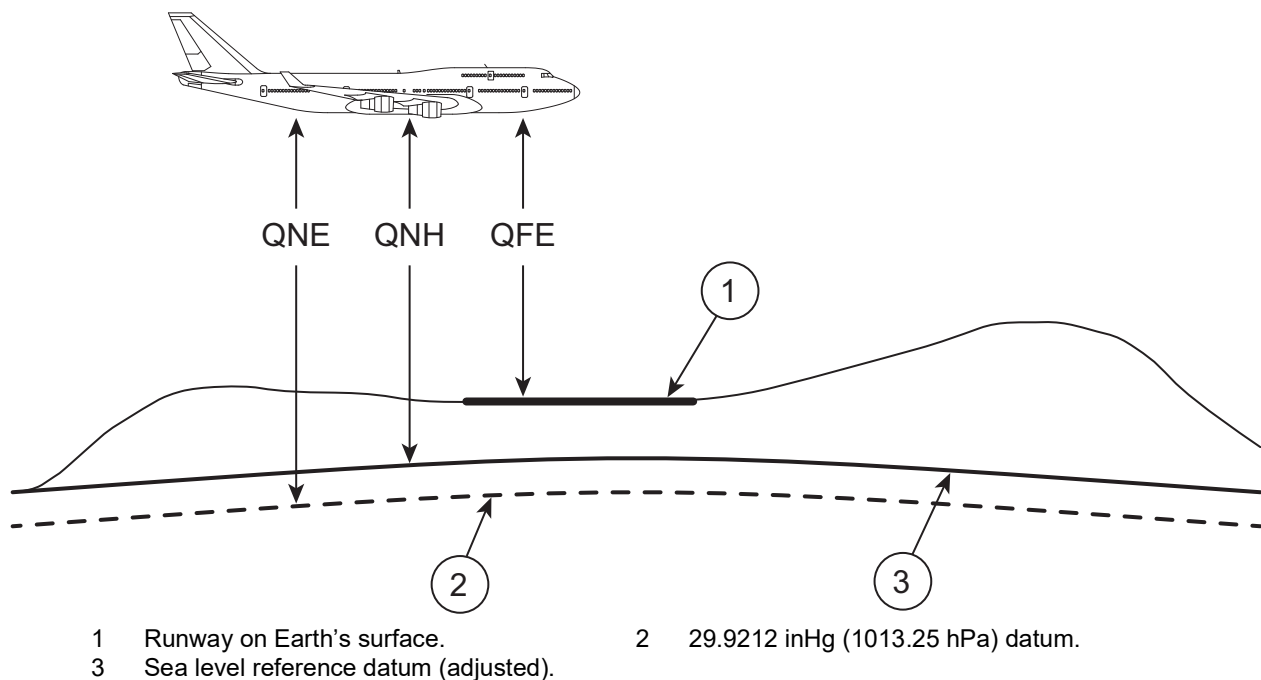

**Figure 6-3: Q Code Visualization**

### 6.15.6 Go to Ground

Returns the instrument and any UUT, connected to it, safely to ground pressure at a controlled rate.

\* Based on tables from ICAO Standard Atmosphere 1964.

# Chapter 6. Reference

## 6.15.7 Control of Aeronautical Parameters

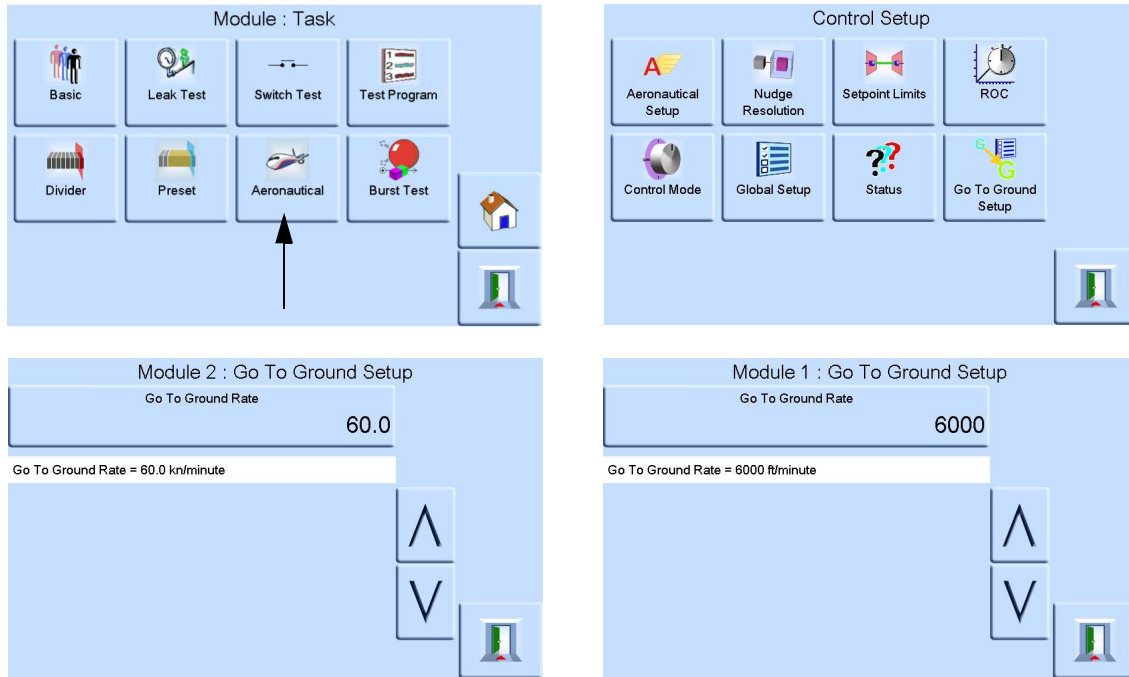

The aeronautical control is an integrated controller. The two modules work together as a dual channel pressure controller Figure 6-4.

In aeronautical mode, the display goes to the last selected parameter:

- Altitude
- Airspeed
- Mach

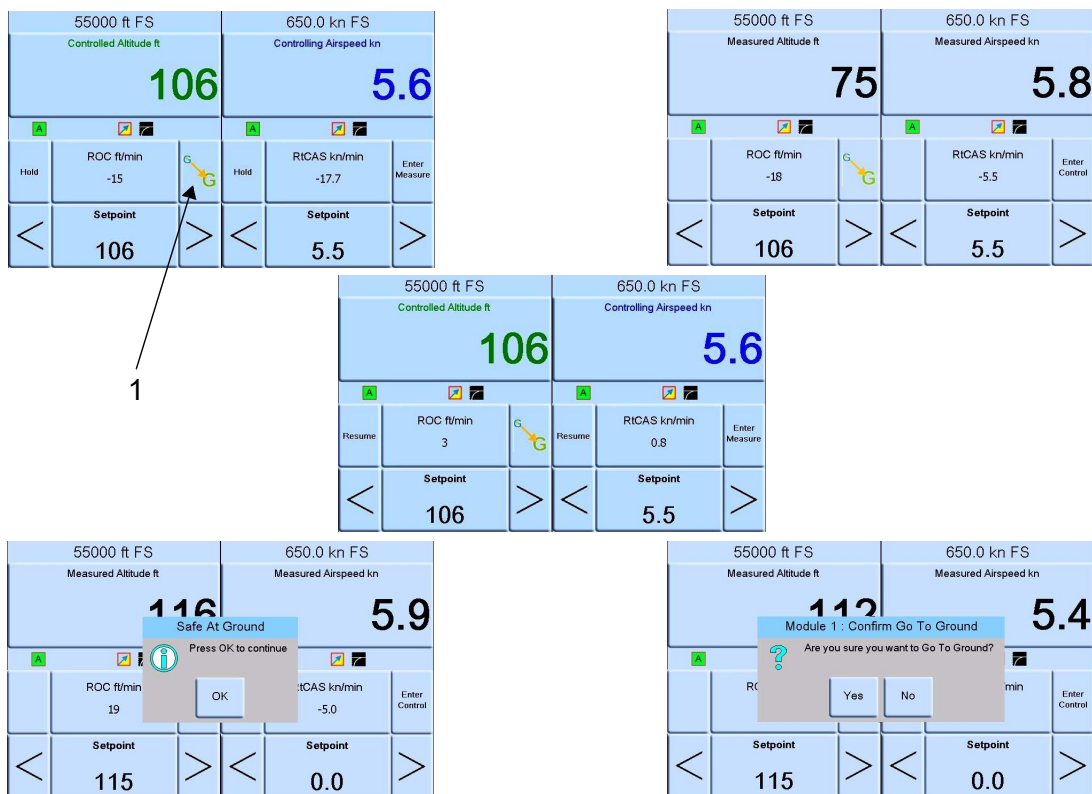

Figure 6-4: Screen Layout



In dual screen mode both altitude and airspeed controllers are set to control mode, by selecting the Enter Control key Figure 6-4.

The Enter Measure key sets both controllers to measure mode.

Select 1 (Go to Ground) in Figure 6-4 to make both controllers go to ground.

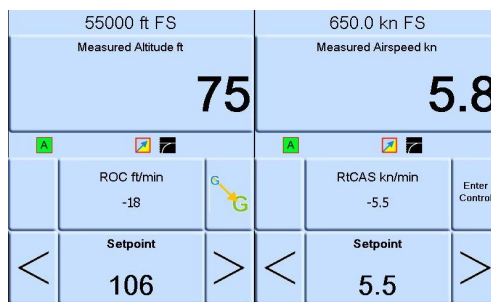

**Figure 6-5: Measurement Mode**

Figure 6-5 shows both controllers in measurement mode.

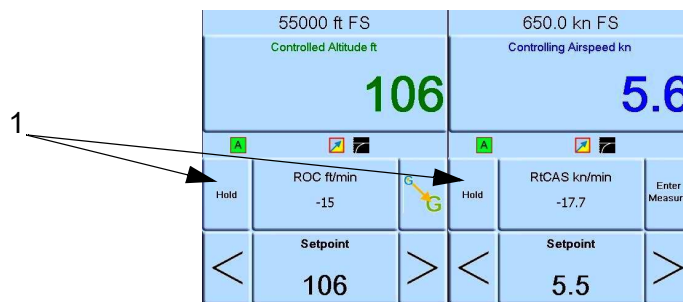

**Figure 6-6: Control Mode**

Figure 6-6 shows both controllers in control mode.

In control mode each control can have an individual set-point.

Select 1 (Hold) in Figure 6-6 to hold a set altitude or speed.

**Note:** The altitude and airspeed controllers are still actively ON, but held at the selected range.

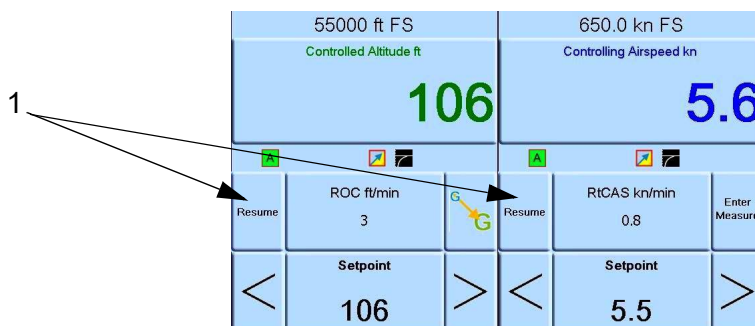

**Figure 6-7: Set-points**

Select 1 (Resume) in Figure 6-7 to continue to the altitude and speed set-points.

### 6.16 Analog Output Option

The analog output option provides a selectable output of voltage or current.

*Selects Analogue Output Range*

*On/Off*

*Update rate of Analogue Output option from the control module.*

**analogue connections**

30V<sub>max</sub>  
30V maximum with respect to chassis.  
Rated output = 24V

*To maintain PACE product safety, external circuits connected to the instrument must meet Safety Extra-Low Voltage (SELV) requirements.*

**15-way female D connector**

*Front view of Analogue Option PCB connector*

30V<sub>max</sub>

Analogue Output Bandwidth = 0.5 x Update Rate (Hz)

**Table 6-10: Pin Number and Function**

Pin Number	Function	Pin Number	Function
1	(not used)	9	(not used)
2	(not used)	10	0 V return
3	(not used)	11	+24 V dc output, 100 mA max
4	(not used)	12	Switch In 1
5	(not used)	13	Switch In 2
6	(not used)	14	Analog output +
7	(not used)	15	Analog output -
8	(not used)		

## 6.17 Volts-free Contact Option

The Volts-free Contact option provides a selectable output of voltage or current.

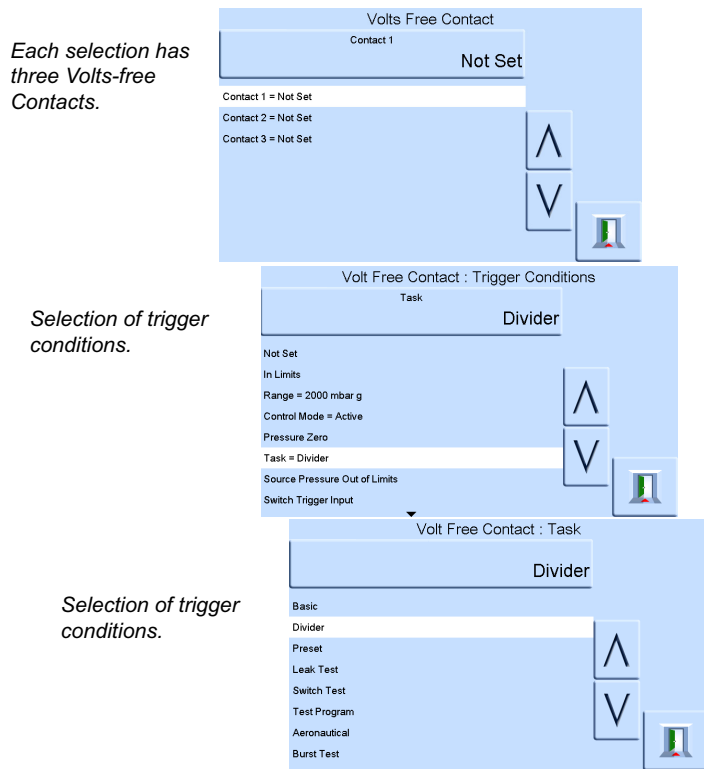

Relay contacts rated at 30 Vdc, 1 A resistive, 200 mA inductive.

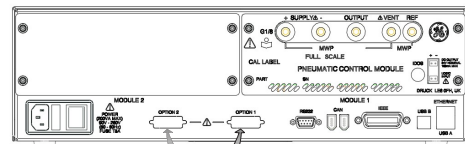

volts-free connections

30V<sub>max</sub> with respect to chassis.  
Rated output = 24V

To maintain PACE product safety, external circuits connected to the instrument must meet Safety Extra-Low Voltage (SELV) requirements.

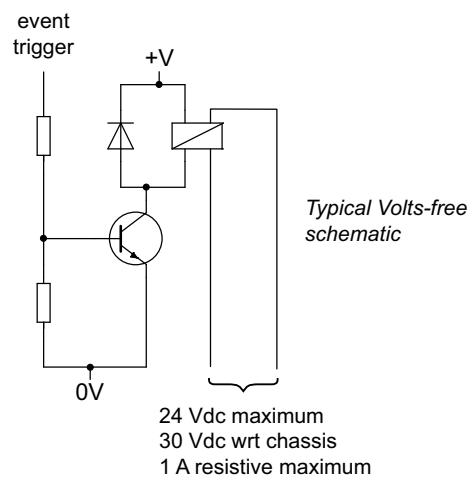

**Table 6-11: Pin Number and Function**

Pin Number	Function	Pin Number	Function
1	Relay 1 normally CLOSED	9	Relay 3 common
2	Relay 1 normally OPEN	10	0V return
3	Relay 1 common	11	+24 V dc output, 100 mA max
4	Relay 2 normally CLOSED	12	Switch Input 1
5	Relay 2 normally OPEN	13	Switch Input 2
6	Relay 2 common	14	(not used)
7	Relay 3 normally CLOSED	15	(not used)
8	Relay 3 normally OPEN		

## 6.18 Burst Pressure Testing Option

The PACE instrument, burst test task can be used to test sudden rupture devices, such as a bursting disc device. This is process is achieved by a predefined test where the user enters pressure values below and above the expected burst disc rupture pressure and slew rates to that speed the test and allow for accurate capture of the burst disc rupture pressure. The test

## Chapter 6. Reference

concludes with the device bursting, the test terminated by the user or the end of pressure is reached.

### 6.18.1 Selecting Burst Pressure Task

Select Task, More then Burst Test:

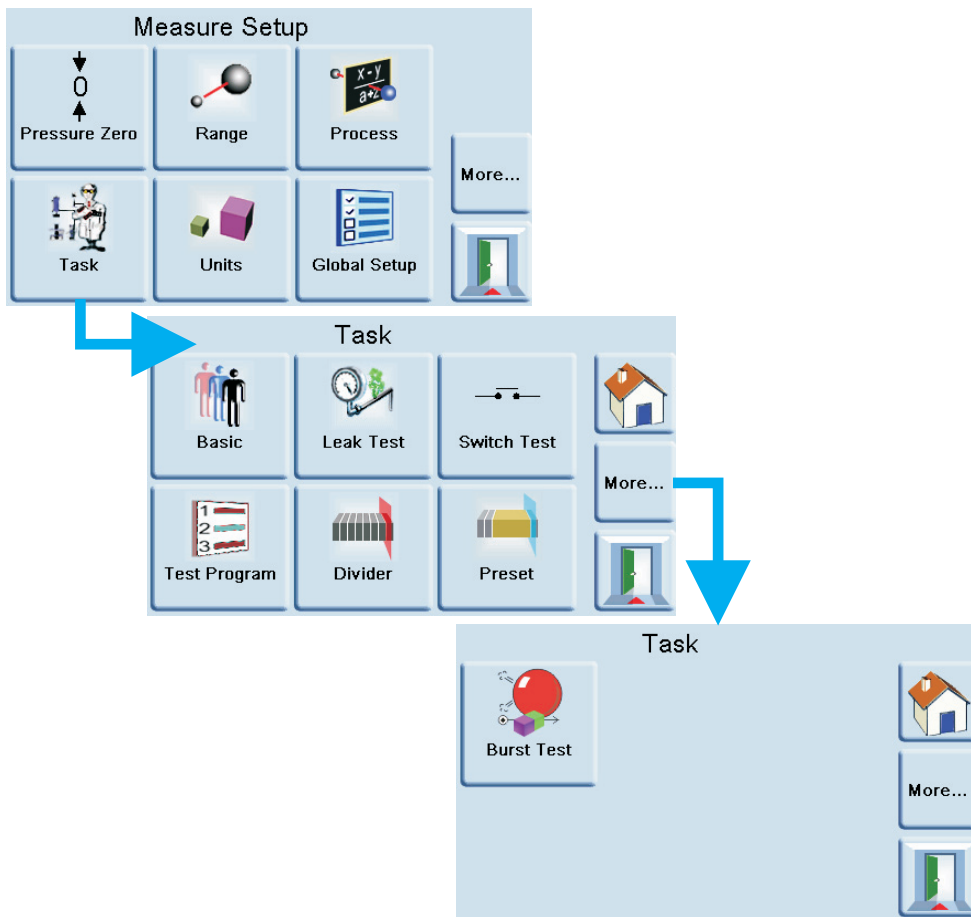

### 6.18.2 Test Parameter Entry

The menu enables the following to be set:

1. Start set-point, to increase the pressure near the expected burst point.
2. Start slew rate, a default value of 10% full-scale can be changed to another value suitable for the device under test. Fast slew rate allowing a fast approach to near the burst area.
3. End set-point, to take the pressure past the expected burst point.

- End slew rate, a default value of 1% full-scale can be changed to another value suitable for the device under test. The slower the slew rate the more accurate the burst point detection pressure.

User selected set-point near the expected burst point.

Start slew rate default value 10% full-scale/second.

User selected set-point of the expected burst point.

End slew rate default value 1% full-scale/second.

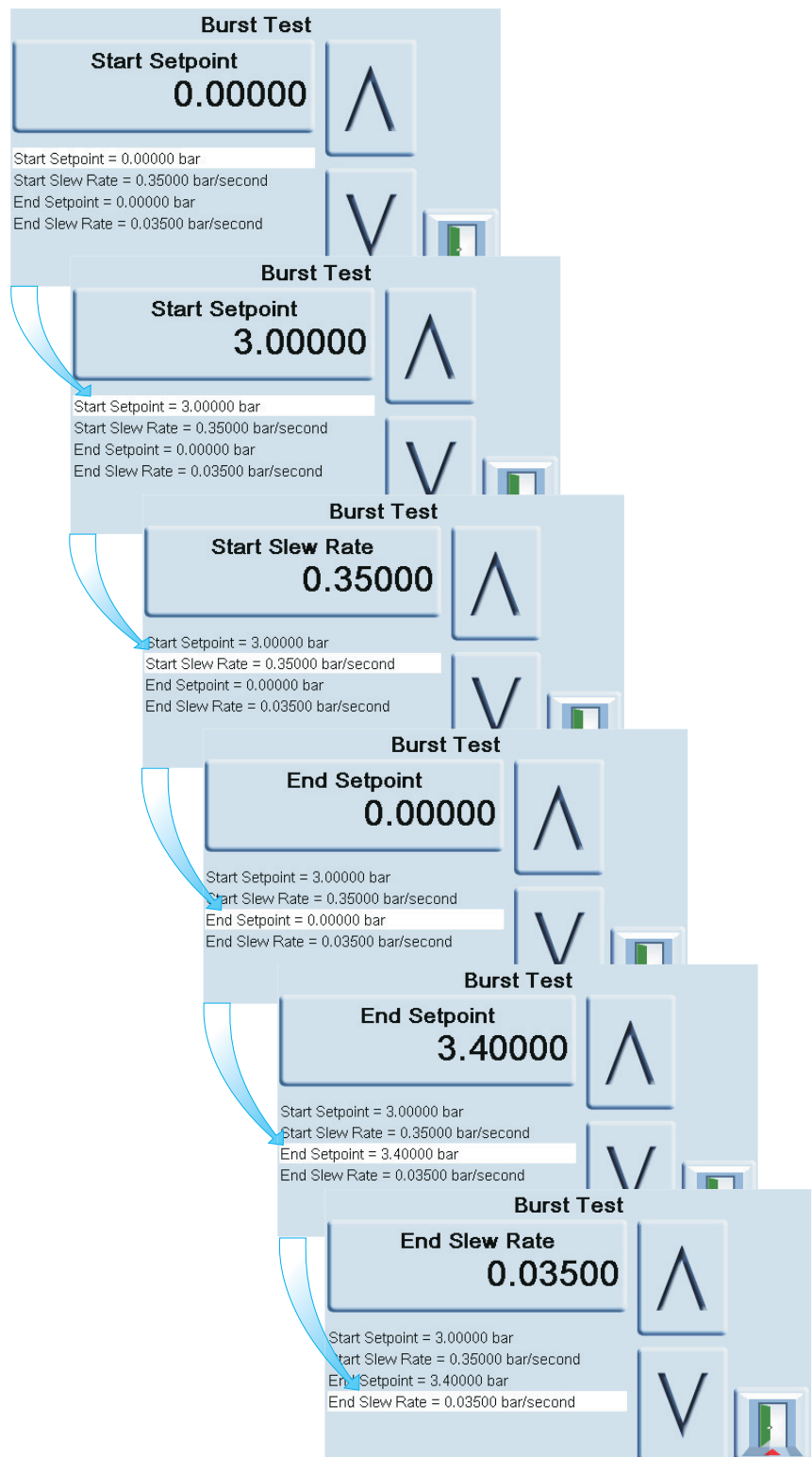

**6.18.3 Example Burst Pressure Test**

The figure below shows the pressure applied to the unit under test.

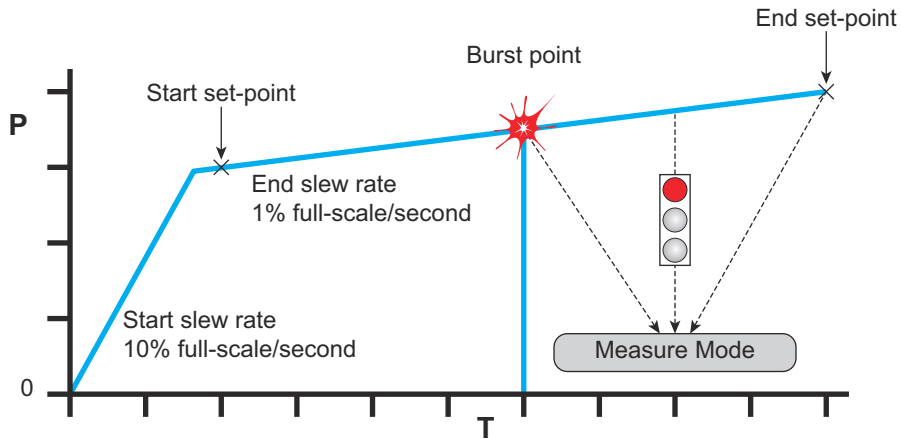

The test continues until:

1. A burst is detected.
2. The test is stopped by the user.
3. The pressure reaches the end set-point.

On completion of the test, the PACE will automatically change to measure mode.

If a burst has been detected, the PACE displays the burst pressure value:



**6.19 Calibration**



**INFORMATION** A PIN protects the Calibration menu against unauthorized use. Each instrument, on delivery, contains the factory set PIN (4321). To continue protecting the supervisor setup menu, the PIN should be changed as soon as possible.

The calibration menu provides the following facilities:

Item	Description
+ve source zero	-
-ve source zero	-
Sensor correction	Selects the range for a three-point calibration routine.
Valve correction	-
Source PDCR correction	Three-point calibration of both source pressure sensors.

Item	Description
Screen calibration	-
Time & Date	Sets instrument clock and calendar.
Change PIN	Changes the Calibration PIN. Enter the existing PIN, the new PIN and confirmation of the new PIN. Should this new PIN become lost it can only be reset by returning the instrument to a Druck Service Center.

The instrument should be returned to the manufacturer or calibration facility, see Section 6.22, "Return Goods/Material Procedure," on page 81.

To find the date of the last calibration, press Measure setup > Status > Calibration history.

## 6.20 Communications - Instrument Emulation

Refer to K0469 - PACE Communications Manual - Instrument Emulation.

### 6.21 Specification

Refer to PACE Module Pressure Controller data sheet.

**Note:** Data sheet 920-561 is contained in the CD-ROM shipped with the product.

### 6.22 Return Goods/Material Procedure

If the unit requires calibration or is unserviceable, return it to the nearest Druck Service Centre listed at: **Druck.com**

Contact the Service Department to obtain a Return Goods/Material Authorization (RGA or RMA). Provide the following information for a RGA or RMA:

- Product (e.g. PACE5000 or PACE6000).
- Serial number.
- Details of defect/work to be undertaken.
- Include any error code(s) if available.
- Operating conditions.

#### 6.22.1 Safety Precautions



**INFORMATION** Service by unauthorized sources will affect the warranty and may not guarantee further performance.

You must inform Druck if the product has been in contact with any hazardous or toxic substance. The relevant COSHH or in the USA, MSDS, references and precautions to be taken when handling.

### 6.23 Packaging Procedure

1. The instrument should be at zero/ambient pressure.
2. Switch off and isolate the electrical power supply to the instrument.
3. Shut off the pneumatic pressure and vacuum supplies to the instrument.
4. Remove the instrument from the equipment rack to access the rear panel.
5. Disconnect the power supply cable and the pneumatic supply hose assemblies.
6. Stow the power supply cable in the packaging below.
7. Remove any pressure adaptors, diffusers and restrictors.

## Chapter 6. Reference

---

If available, use the original packing material. When using packing materials other than the original, do the following:

8. Fit protection to all the ports to prevent ingress of moisture and dirt.  
**Note:** Use the original red plastic plugs or low tack masking tape.
9. Wrap unit in polyethylene sheeting.
10. Select a double-wall cardboard container.
  - Inside dimensions must be at least 15 cm (6") greater than the equipment
  - The carton must meet test strength requirements of  $\geq 125$  kg (275 lbs).
11. Protect all sides with shock-absorbing material to prevent equipment movement within the container.
12. Seal carton with approved sealing tape.
13. Mark carton "FRAGILE" on all sides, top, and bottom of shipping container.

The following conditions apply for both shipping and storage:

- Temperature range:  $-20^{\circ}$  to  $+70^{\circ}\text{C}$  ( $-4^{\circ}$  to  $+158^{\circ}\text{F}$ ).

### 6.24 Vacuum System Parts

The parts list below lists a typical system to supply vacuum, enabling the control of sub-atmospheric pressures by the PACE instrument. Part numbers quoted in the table are taken from the BOC Edwards Vacuum Products Catalog. For more information, go to:

[www.bocedwards.com](http://www.bocedwards.com)

**Table 6-12: Vacuum System Parts**

Part Number	Quantity	Description
A653-01-903	1	RV5 115/230Vac Vacuum Pump, 91 litre/min
A462-26-000	1	EMF10 Mist Filter
C105-14-436	2	NW25/NW10 Reducer fitting
C105-11-411	1	NW10 T-Piece Fitting
C417-21-000	1	IPVA10EK Air Admittance Valve, Normally Open
C105-11-287	4	NW10 Flexible Pipeline 1m, S/S
C105-12-401	5	NW10 Clamping Ring
C105-11-398	5	NW10 Centering Ring
C105-14-401	3	NW25 Clamping Ring
C105-14-398	3	NW25 Centering Ring
C105-12-349	1	NW16/10 Centering Ring
C105-01-103	1	NW16 to ¼NPT Male Adapter, S/S
FL-20-K	1	FL20K Foreline Trap



## Appendix A. Pressure Units and Conversion Factors

Pressure Units	Factor (hPa)	Pressure Units	Factor (hPa)
mbar	1.0	cmH <sub>2</sub> O @ 20°C	0.978903642
bar	1000.0	mH <sub>2</sub> O @ 20°C	97.8903642
Pa (N/m <sup>2</sup> )	0.01	kg/m <sup>2</sup>	0.0980665
hPa	1.0	kg/cm <sup>2</sup>	980.665
kPa	10.0	torr	1.333223684
MPa	10000.0	atm	1013.25
mmHg @ 0°C	1.333223874	psi	68.94757293
cmHg @ 0°C	13.33223874	lb/ft <sup>2</sup>	0.4788025898
mHg @ 0°C	1333.223874	inH <sub>2</sub> O @ 4°C	2.4908891
inHg @ 0°C	33.86388640341	inH <sub>2</sub> O @ 20°C	2.486413
mmH <sub>2</sub> O @ 4°C	0.0980665	inH <sub>2</sub> O @ 60°F	2.487641558
cmH <sub>2</sub> O @ 4°C	0.980665	ftH <sub>2</sub> O @ 4°C	29.8906692
mH <sub>2</sub> O @ 4°C	98.0665	ftH <sub>2</sub> O @ 20°C	29.836983
mmH <sub>2</sub> O @ 20°C	0.097890364	ftH <sub>2</sub> O @ 60°F	29.8516987

To convert from pressure VALUE 1 in pressure UNITS 1, to pressure VALUE 2 in pressure UNITS 2, calculate as follows:

$$\text{VALUE 2} = \text{VALUE 1} \times \frac{\text{FACTOR 1}}{\text{FACTOR 2}}$$

## Appendix A. Pressure Units and Conversion Factors

---

## Appendix B. Air Density

Values of air density ( $\text{kgm}^{-3}$ ) for air of relative humidity 50% and containing 0.04% carbon dioxide by volume.

**Table B-1: Air Density Values**

Air Pressure (kPa) <sup>a</sup>	Air Temperature (°C)						
	14	16	18	20	22	24	26
87	1.052	1.045	1.037	1.029	1.021	1.014	1.006
88	1.064	1.057	1.049	1.041	1.033	1.025	1.018
89	1.077	1.069	1.061	1.053	1.045	1.037	1.029
90	1.089	1.081	1.073	1.065	1.057	1.049	1.041
91	1.101	1.093	1.085	1.077	1.069	1.061	1.053
92	1.113	1.105	1.097	1.089	1.080	1.072	1.064
93	1.125	1.117	1.109	1.100	1.092	1.084	1.076
94	1.137	1.129	1.121	1.112	1.104	1.096	1.088
95	1.149	1.141	1.133	1.124	1.116	1.108	1.099
96	1.162	1.153	1.145	1.136	1.128	1.119	1.111
97	1.174	1.165	1.156	1.148	1.139	1.131	1.123
98	1.186	1.177	1.168	1.160	1.151	1.143	1.134
99	1.198	1.189	1.180	1.172	1.163	1.154	1.146
100	1.210	1.201	1.192	1.184	1.175	1.166	1.158
101	1.222	1.213	1.204	1.196	1.187	1.178	1.169
102	1.234	1.225	1.216	1.207	1.199	1.190	1.181
103	1.247	1.237	1.228	1.219	1.210	1.201	1.193
104	1.259	1.249	1.240	1.231	1.222	1.213	1.204
105	1.271	1.261	1.252	1.243	1.234	1.225	1.216
106	1.283	1.274	1.264	1.255	1.246	1.237	1.228



a. 100 kPa = 1 bar.

## Appendix B. Air Density

---

## Appendix C. User Interface Icons

The following icons are used in the PACE series of instruments. Not all icons are used in every PACE instrument.

Display Icons in Setup Menus					
Icon	Function	Icon	Function	Icon	Function
	Active		Aero setup		Aeronautical
	Airspeed range		Alarm		Altitude range
	Area of use		Asterisk		Auto range
	Audio volume		Auto zero		Backlight
	Barometer		Basic		Burst pressure control mode
	Calibration		Calibration history		Change supervisor PIN
	Communications		Contrast		Control mode
	Copy		Correction analog output		Correction sensor
	Correction source sensor		Correction valve		Current setup
	Date & time		Delete		Diagnostic analog output
	Diagnostic barometric option		Diagnostic control sensor		Diagnostic controller
	Diagnostic general		Diagnostic RS-232		Diagnostic source sensor
	Diagnostic vacuum sensor		Diagnostic volt-free		Diagnostics
	Display		Divider		Error

## Appendix C. User Interface Icons

Display Icons in Setup Menu					
Icon	Function	Icon	Function	Icon	Function
	Escape		Ethernet		Ethernet not connected
	Ethernet connected		Exclamation		Fault history
	Gas head pressure		Gauge mode		Global setup
	Go-to-ground		Hardware build		Home
	Idle time-out		IEEE 488		Information
	In-limits		Instrument		Instrument accuracy
	Instrument alias name		Language		Leak test
	Lock		Lock tasks		Logic output
	Max-min		Max peak		Min peak
	Nudge		Passive mode		Percentage
	PIN		Power-up		Preset
	Pressure		Pressure filter		Process
	Protective vent		Question		Range
	Recall user setup		Reset use log		Resolution
	Re-try		Roughing		RS-232
	Restore to as shipped settings		Restore settings 2		Run

## Display Icons in Setup Menu

Icon	Function	Icon	Function	Icon	Function
	Save as shipped		Save recall user setup settings		Save user setup
	Screen mode		Screen saver		Select range
	Set-point disable/enable		Set-point limits		Set-point higher limit
	Set-point lower limit		Set date		Set serial number
	Set time		Setup zero		Slew rate linear
	Slew rate max rate		Software build		Software upgrade history
	Software upgrade		Status		Status area
	Step (single)		Stop		Supervisor setup
	Switch test		Tare		Support
	Task		Test program		Test program copy
	Test program delete		Timing		Time out
	Timed zero		Units		User defined units
	Use log		Use log history		Vent
	Vent time out		Vent Yes/No		Vent setup
	Warning		Zero analog output		Zero history
	Zero				

## Appendix C. User Interface Icons

---





## Office Locations

### Headquarters

**Leicester, UK**  
☎ +44 (0) 116 2317233  
✉ [gb.sensing.sales@bakerhughes.com](mailto:gb.sensing.sales@bakerhughes.com)

### China

**Guangzhou**  
☎ +86 173 1081 7703  
✉ [dehou.zhang@bakerhughes.com](mailto:dehou.zhang@bakerhughes.com)

### Germany

**Frankfurt**  
☎ +49 (0) 69-22222-973  
✉ [sensing.de.cc@bakerhughes.com](mailto:sensing.de.cc@bakerhughes.com)

### Japan

**Tokyo**  
☎ +81 3 6890 4538  
✉ [gesitj@bakerhughes.com](mailto:gesitj@bakerhughes.com)

### UAE

**Abu Dhabi**  
☎ +971 528007351  
✉ [suhel.aboobacker@bakerhughes.com](mailto:suhel.aboobacker@bakerhughes.com)

### Australia

**North Sydney**  
☎ 1300 171 502  
✉ [custcare.au@bakerhughes.com](mailto:custcare.au@bakerhughes.com)

### China

**Shanghai**  
☎ +86 135 6492 6586  
✉ [hensen.zhang@bakerhughes.com](mailto:hensen.zhang@bakerhughes.com)

### India

**Bangalore**  
☎ +91 9986024426  
✉ [aneesh.madhav@bakerhughes.com](mailto:aneesh.madhav@bakerhughes.com)

### Netherlands

**Hoewelaken**  
☎ +31 334678950  
✉ [nl.sensing.sales@bakerhughes.com](mailto:nl.sensing.sales@bakerhughes.com)

### USA

**Boston**  
☎ 1-800-833-9438  
✉ [custcareboston@bakerhughes.com](mailto:custcareboston@bakerhughes.com)

### China

**Beijing**  
☎ +86 180 1929 3751  
✉ [fan.kai@bakerhughes.com](mailto:fan.kai@bakerhughes.com)

### France

**Toulouse**  
☎ +33 562 888 250  
✉ [sensing.FR.cc@bakerhughes.com](mailto:sensing.FR.cc@bakerhughes.com)

### Italy

**Milan**  
☎ +39 02 36 04 28 42  
✉ [csd.italia@bakerhughes.com](mailto:csd.italia@bakerhughes.com)

### Russia

**Moscow**  
☎ +7 915 3161487  
✉ [aleksey.khamov@bakerhughes.com](mailto:aleksey.khamov@bakerhughes.com)

## Services and Support Locations

### Tech Support

**Global**  
✉ [mstechsupport@bakerhughes.com](mailto:mstechsupport@bakerhughes.com)

### France

**Toulouse**  
☎ +33 562 888 250  
✉ [sensing.FR.cc@bakerhughes.com](mailto:sensing.FR.cc@bakerhughes.com)

### UAE

**Abu Dhabi**  
☎ +971 2 4079381  
✉ [gulfservices@bakerhughes.com](mailto:gulfservices@bakerhughes.com)

### Brazil

**Campinas**  
☎ +55 11 3958 0098, +55 19 2104 2983  
✉ [mcs.services@bakerhughes.com](mailto:mcs.services@bakerhughes.com)

### India

**Pune**  
☎ +91-2135-620421~425  
✉ [mcindia.inhouseservice@bakerhughes.com](mailto:mcindia.inhouseservice@bakerhughes.com)

### UK

**Leicester**  
☎ +44 (0) 116 2317107  
✉ [sensing.grobycc@bakerhughes.com](mailto:sensing.grobycc@bakerhughes.com)

### China

**Changzhou**  
☎ +86 400 818 1099  
✉ [service.mcchina@bakerhughes.com](mailto:service.mcchina@bakerhughes.com)

### Japan

**Tokyo**  
☎ +81 3 3531 8711  
✉ [service.druck.jp@bakerhughes.com](mailto:service.druck.jp@bakerhughes.com)

### USA

**Billerica**  
☎ +1 (281) 542-3650  
✉ [namservice@bakerhughes.com](mailto:namservice@bakerhughes.com)