

# ENGLAON ANYWHERE

## Instruction Manual

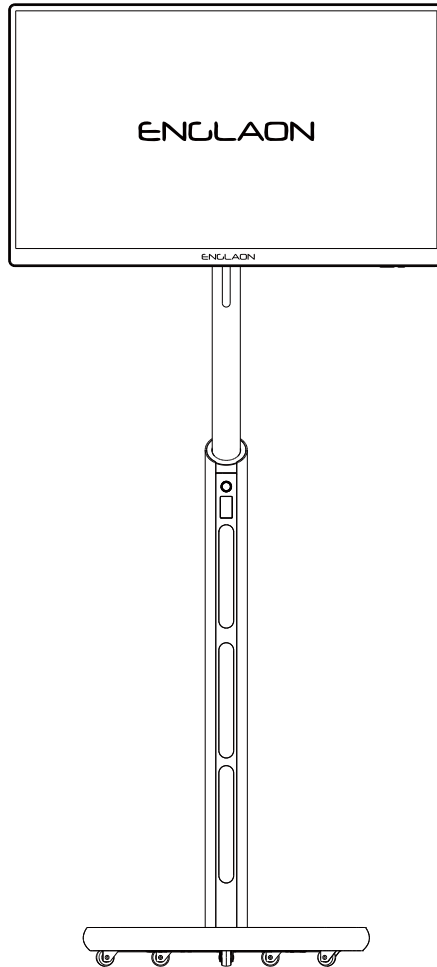

LED32P90

---

**Note:**

Thank you for choosing our product. In order to ensure your safe use of this product please read this manual carefully and keep it properly before using this product.

# Preface

Thanks for using the smart screen

Before starting the device , Please read the product features and notes in the user manual carefully

## Warning

- You can't use other power adapter to power this device
- Do not block or cover the ventilation hole at the back of the device
- Do not use or store this machine in dusty, humid and high temperature environment.
- When the machine breaks down, please do not disassemble and repair it by yourself. please contact the original factory or dealer to solve the problem.
- To prevent electric shock, do not step on the power cord or power adapter, do not continue to use damaged power cord
- During thunderstorms or this machine is not in use for a long time, please unplug the power cord
- Try not to touch the display screen during transportation or use, do not squeeze the display screen hard, and do not damage the display screen with sharp weapons or hard objects, so as to avoid damage to the display screen.
- To avoid damage to the display screen, do not use sharp objects or hard objects to hit the display screen
- Please clean the machine with a dry soft cloth or a soft cloth slightly dipped in a flexible cleaner. Do not use any kind of solvent, such as alcohol or gasoline, or it may damage the surface treatment layer.
- Children must be made aware of the dangers of climbing this product, which can cause serious life injury if it is dropped or dumped.
- Do not place the product in an unstable or inclined position.
- To avoid tripping, be sure to arrange the cables connected to this equipment in time



Safe for use in non-tropical climates only

# Packing list

After opening the package, please confirm the contents of the package below.

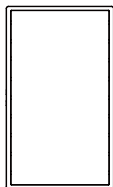

Monitor x1

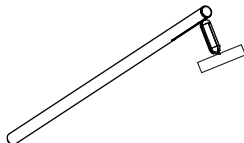

Stand pole x1

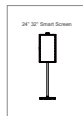

User manual x1



Circular base x1



Power cord x1

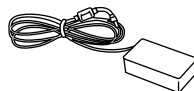

Adapter x1



(M5\*16)

Connect the base to the column  
screws x4

# Installation guide

1. Take out polystyrene from the carton;

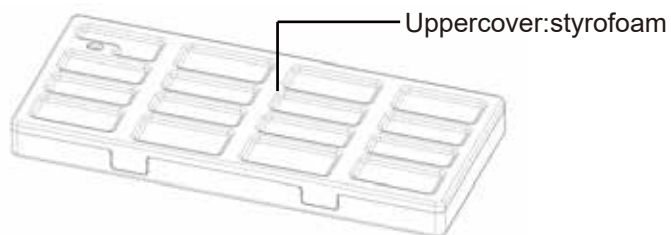

\*More than 2 adults are recommended to work

2. Open the polystyrene and remove the polystyrene cover;

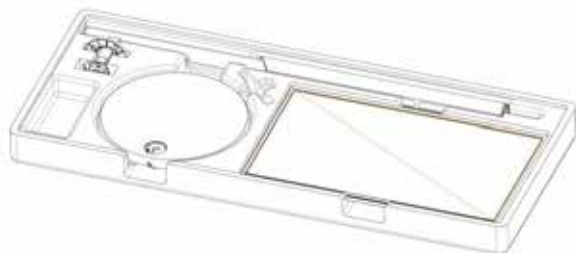

3. Take out the product, place the screen facing down on the polydragon, as shown in the picture below;



# Installation guide

4. Take out the vertical rod, connect it with the quick disassembly position of the display screen, and then put the chassis on the other side of the Poly dragon, pass the power cord at the bottom of the lower rod through the round hole of the chassis, and connect it with the power cord of the chassis.

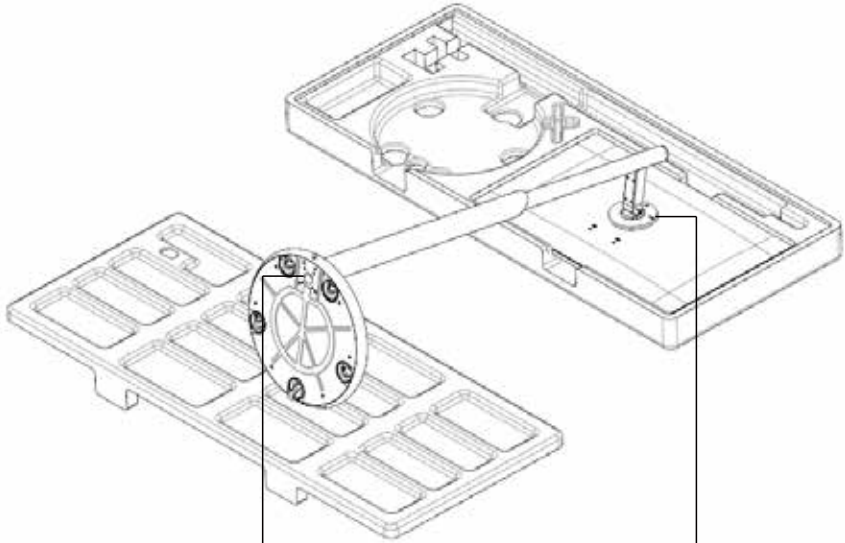

Schematic drawing

Schematic drawing

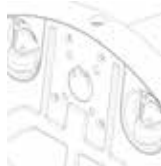

Pull out the wire from the vertical rod and connect it to the power cord of the chassis, close the interface cover, and fix the screws (built-in screw).

Pull out the Type-C cable from the vertical rod and connect it to the screen interface, and then lock it

# Appearance introduction

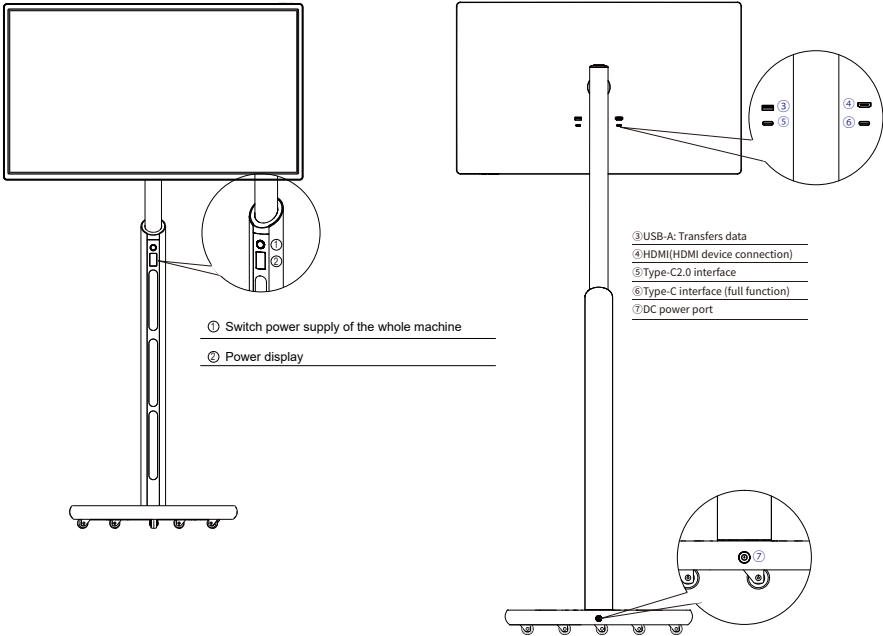

## Connect and power on

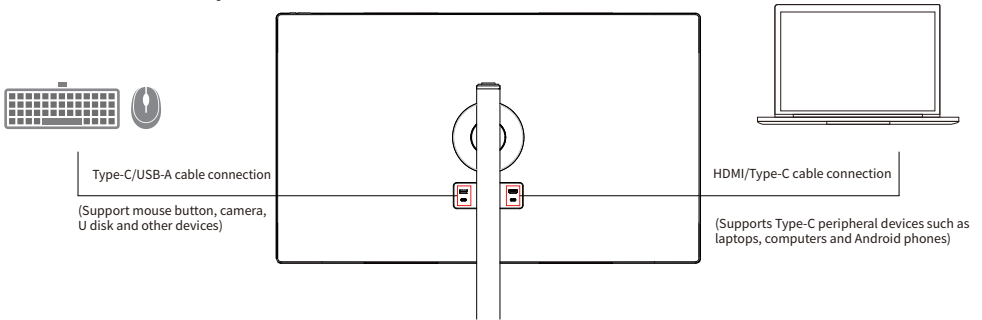

### 1. Connection of signal Q line

1.1, support HDMI signal connection, use HDMI cable to connect the display to the signal end

1.2, 12 Support Type-C signal connection, use the Type-C line to connect the display to the signal end. Note: The Type-C interface at the signal end has the transmission function

### 2. Connect the USB peripheral

You can also connect USB/Type-C peripherals through USB/Type-C docking; When connecting peripherals, the default is Android, if you need to switch, you need to switch in the menu

### 3. Menu Settings

Long press the menu key to wake up from sleep, short press the menu key to activate the menu to set

# Basic parameters

<b>1.Display Features:</b>	
Size	32"
Brightness	250cd/m2
Resolution	1920×1080 , FHD
Contrast	1000:1
Refresh Rate	60Hz
Display Colors	16.7M
Aspect Ratio	16:9
Viewing Angle	178H/178V
Response Time	6ms
<b>2.Product Measurement:</b>	
OutSide Box Dim(W*D*H)	1416*610*145 mm
With Stand(W*D*H)	730*410*1370mm
Without Stand(W*D*H)	730*150*430mm
N.W/ G.W	11KG/20KG
<b>3.Power Requirements:</b>	
Input Voltage	100-240V AC 50/60HZ
Standby Consumption	< 0.5W
Power In	24V 4A
Built-in Battery Capacity	152WH (19.2V / 7.92A)
Full Battery Life	3H
Power ON Consumption	60W
Speaker Consumption	5W*2
<b>4.I/O Port:</b>	
HDMI	1
USB	1
Type-C	2
WIFI	WIFI 6
BLUETOOTH	5
<b>5.Special Functions:</b>	
Move	YES
Recharge	YES
Touch	YES
Image Autorotaion	YES
CPU	6 CORE ( RK3399 Cortex-A72*2+Cortex-A53*4)
GPU	T860MP4
RAM	4G
ROM	64G
OS	Android 11
<b>6.Structure:</b>	
Univsal Wheel	YES
Expansion Link	YES
<b>7.Stand:</b>	
High And Low Adjustment	YES
Up And Down Rotation	YES
Left And Right Rotation	YES
Forward And Rear Rotation	YES
<b>8.Accessories :</b>	
Power Adapter	1
Manual	1
Installation Instructions	1

# Pushbuttons description

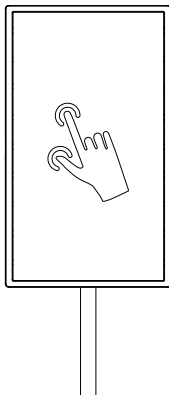

## Touch

Adopt INCELL full HD ten-point capacitive touch LCD screen.  
To keep the screen clean, make sure it is clean.

### Note:

the battery recharge from 1% to 95% above for about 6 hours at the device using the battery recharge from 0% to more than 95% for about 4 hours after the device was shutdown and the battery life of the equipment is about 2.5 hours after being fully charged. The service time of the product increases, and the battery life decrease proportionally.

In order to prolong the service life of the battery, it is recommended to charge the battery after using it for a period of time. After the battery is full, unplug the charger.

Do not keep the battery fully charged all the time, and the battery cannot be charged in the extreme environment.

※ The standard operating times in the instruction manual are based on our laboratory test data; actual times may vary depending on the conditions of use. Actual times may vary depending on the conditions of use.

 Note: Users are strictly prohibited from replacing or disassembling the battery pack to avoid the risk of explosion caused by improper installation or by using the wrong type of battery. If necessary, please contact the official customer service to deal with related issues.

This symbol on the product or in the instructions means that your electrical and electronic equipment should be disposed of at the end of its life separately from your household waste. There are separate collection systems for recycling in your country. For more information, please contact the local authority or your retailer where you purchased the product.

