

ENGLAON

24" FHD LED TV DVD COMBO

Model: LED24X80

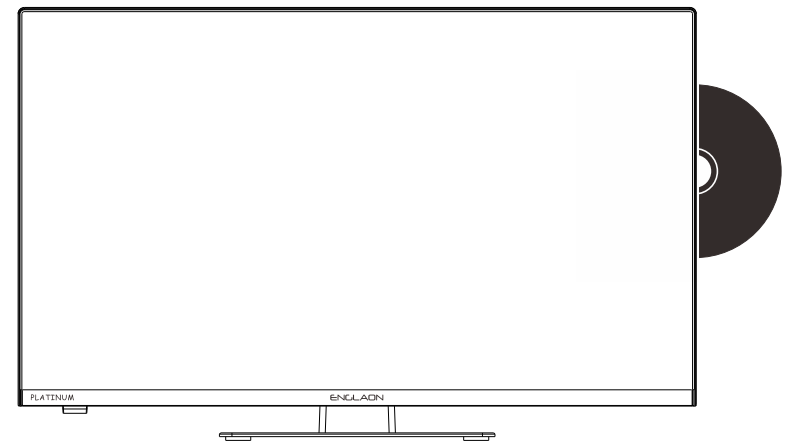

User's Manual

Please Read this manual carefully and retain for future reference

USER'S MANUAL

Scan to download the Manual



For support please contact our service department at service@englaon.com.au

Safety Information

IMPORTANT SAFETY INSTRUCTIONS

Read these instructions.
Keep these instructions.
Heed all warnings.
Follow all instructions.
Do not use this apparatus near water.
Clean only with dry cloth.
Do not block any ventilation openings. Install in accordance with the manufacturer's instructions.
Do not install near any heat sources such as radiators, heat registers, stoves, or other apparatus (including amplifiers) that produce heat.
Do not defeat the safety purpose of the polarized or grounding plug. A polarized plug has two blades with one wider than the other. A grounding plug has two blades and a third grounding prong. The wide blade or the third prong is provided for your safety. If the provided plug does not fit into your outlet, consult an electrician for replacement of the obsolete outlet.
Protect the power cord from being walked on or pinched particularly at the plugs, convenience receptacles, and at the point where they exit from the apparatus.
Only use attachments/accessories specified by the manufacturer.
Use only with the cart, stand, tripod, bracket, or table specified by the manufacturer, or sold with the apparatus. When a cart or rack is used, use caution when moving the cart/apparatus combination to avoid injury from tip-over.



Unplug the apparatus during lightning storms or when unused for long periods of time.

Refer all servicing to qualified personnel. Servicing is required when the apparatus has been damaged in any way, such as power supply cord or plug is damaged, liquid has been spilled or objects have fallen into the apparatus has been exposed to rain or moisture, does not operate normally, or has been dropped.

CAUTION: These servicing instructions are for use by qualified service personnel only. To reduce the risk of electric shock, do not perform any servicing other than that contained in the operating instructions unless you are qualified to do so.

WARNING : To reduce the risk of fire or electric shock, do not expose this apparatus to rain or moisture. The apparatus shall not be exposed to dripping or splashing and that objects filled with liquids, such as vases, shall not be placed on apparatus.

WARNING: The mains plug is used as disconnect device, the disconnect device shall remain readily operable.



- This lightning flash with arrowhead symbol within an equilateral triangle is intended to alert the user to the presence of non-insulated "dangerous voltage" within the product's enclosure that may be of sufficient magnitude to constitute a risk of electric shock.

- Warning: To reduce the risk of electric shock, do not remove cover (or back) as there are no user-serviceable parts inside. Refer servicing to qualified personnel.

- The exclamation point within an equilateral triangle is intended to alert the user to the presence of important operating and maintenance instructions in the literature accompanying the appliance.

Apparatus with class I construction shall be connected to a mains socket outlet with a protective earthing connection.

Important Safety Precautions

Safety

Please, immediately pull out the AC power plug from adapter if there is an abnormal sound or smell or the LED TV has sound but no picture, and contact after sales support.



The LED TV should be kept free from rain, moisture and dust to prevent electrical shock and short circuits. Do not cover the ventilation openings with table clothes, curtains, newspapers, etc.

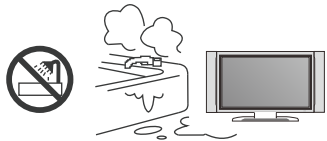

The LED TV should be kept from high temperature heating sources or direct sunlight. Good ventilation is required. Allow 10 cm. between the LED TV and other appliances or built-in cabinet walls.

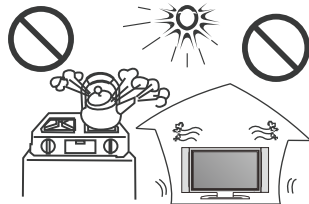

When you wipe the front cabinet, please make sure the power plug is pulled out and use a soft, dry, lint-free cloth and handle it with care. Do not repeatedly wipe the panel, nor scrape, tap or strike the panel with a hard object.

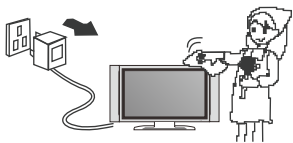

Do not wipe the LED TV with any petrol, chemical or alcohol based solvents as it will lead to product damage of the panel and cabinet.



When the television receiver is not used for an extended period of time, it is advisable to disconnect the AC power cord from the AC outlet.



Important Safety Precautions

Safety

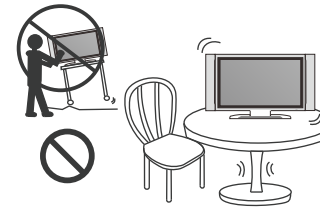

Do not place the LED TV on an unstable surface.

Do not place the power cord or other cables across a walkway in case it is trampled on. Do not overload the power cord or power socket. When the power plug is used to disconnect and connect the device, it should easily go into the power source.

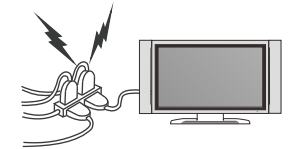

Do not disassemble the back cover, as it contains high voltages inside and will cause electric shock. Only qualified professionals should conduct internal adjustments, maintenance, and checks.

The TV set should not be subjected to water droplets, vapor, or splash. This equipment should not be placed on objects filled with liquids. Do not place flame sources, such as lit candles, on or near the LED TV. Please, pull out the power plug and contact after sales support if there are abnormal objects or water in the TV.

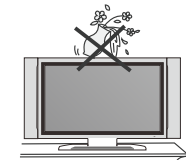

Pull out the power cord and antenna cable during electrical storms so the LED TV is not damaged by electrical surges. Keep all people away from the antenna cable during electrical storms.

Table of Contents

Introduction	
Features	2
Accessories	2
Specifications	3
Hardware Configuration	3
General Description	4
Overview of front and side panel	4
Overview of back panel	5
Assembling Stand Process	6-8
Overview of remote control	6-8
Installing Batteries in the Remote Control	9
Antenna connection	
External Connection	10-11
Connecting DVD Player/Set-Top Box via HDMI	10
Connecting EARPHONE	11
Supporting signals	11
Basic operation	12
Turning the TV On and Off	12
OSD Menu Operations	13-31
DVD	32-33
Troubleshooting	34
Picture defects and the reason	35

Introduction

Features

Input terminals used for external equipment connection

One AUDIO L/R output	Two HDMI input
One EARPHONE output	Two USB input
One RF input	One COAXIAL output
	One RJ45 input

Accessories

Please make sure the following items are included with your LED TV. If any items are missing, contact your dealer.



Remote Control

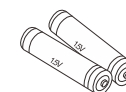

Batteries (AAx 2)

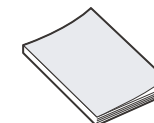

Instructions Manual

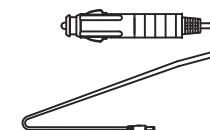

12V/24V Accessory Plug



Column bracket

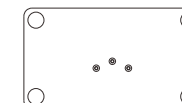

Base



Screws

Introduction

Specifications

Display screen type	Color LED display
Model	LED24X80
The maximum resolution	1920X1080
Power supply	DC 12V $\overline{\text{=}}$ 4A
TV system	PAL/DVB-T
Frequency range	48. 25MHz - 863. 25MHz
Video input Format	PAL/NTSC
Antenna input	antenna socket 75 Ω
Average Power Consumption	32W
Dimensions (LXWXH)	With Stand: 541.4 x 125 x 345.7 mm
	Without Stand: 541.4 x 47.1 x 318.3mm
Weight (Net weight)	3.7 Kg
Operation environment temperature	0 $^{\circ}$ C-35 $^{\circ}$ C

Remarks:

The above listed specifications and data are subject to change without prior notice.

Hardware Configuration

CPU	ARM Cortex-A55 quad core
GPU	Mali G31MP2
DDR SIZE	1.5 GB
eMMC Flash	8 GB

General Description

Overview of front and side panel

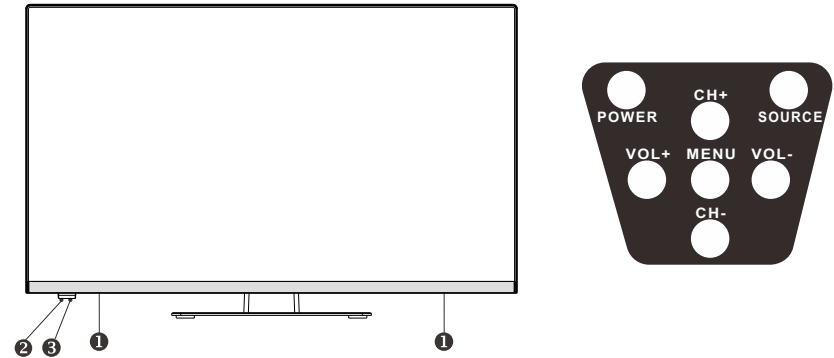

- 1** SPEAKER
- 2** REMOTE CONTROL SENSOR
- 3** POWER INDICATOR
White: standby mode.
Transparent: power on mode.
- 4** SOURCE
Toggles between all the available input sources
- 5** MENU
Press to see an on-screen menu of your TV's features.
- 6** CH+/-
Press to change channels.
In the on-screen menu, use the CH +/- buttons as up/down arrow buttons.
- 7** VOL+/-
Press to increase or decrease the volume.
In the on-screen menu, use the VOL +/- buttons as left/right arrow buttons.
- 8** POWER
Press POWER button to toggle between normal and standby mode.

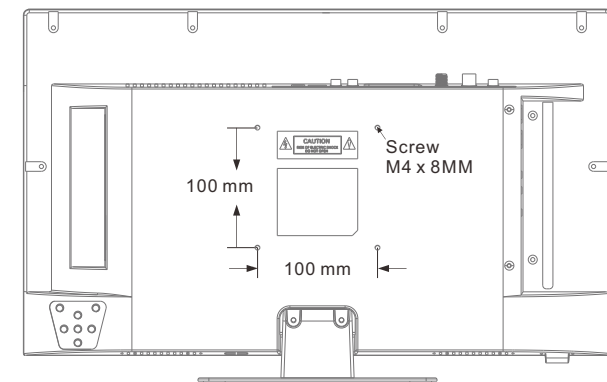

General Description

Overview of back panel

Side port

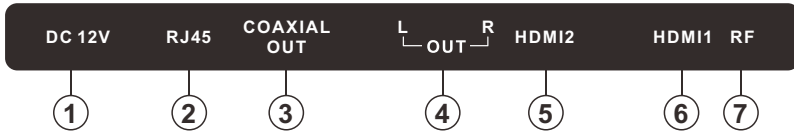

Port



- | | |
|---|--|
| <p>1. DC 12V
DC input.</p> <p>2. RJ45
Ethernet connection.</p> <p>3. COAXIAL
Coaxial Digital audio output.</p> <p>4. L/R
Connect to the audio output jacks on your amplifier/home theater.</p> <p>5. HDMI2
Connecting for HDMI signal.</p> | <p>6. HDMI1
Connecting for HDMI signal.</p> <p>7. RF
Connected to external antenna to receive the ATV/DTV program in ATV/DTV mode.</p> <p>8. USB 2
USB input.</p> <p>9. EARPHONE
Connecting for headphone.</p> <p>10.USB 1
USB input.</p> |
|---|--|

Assembling Stand Process

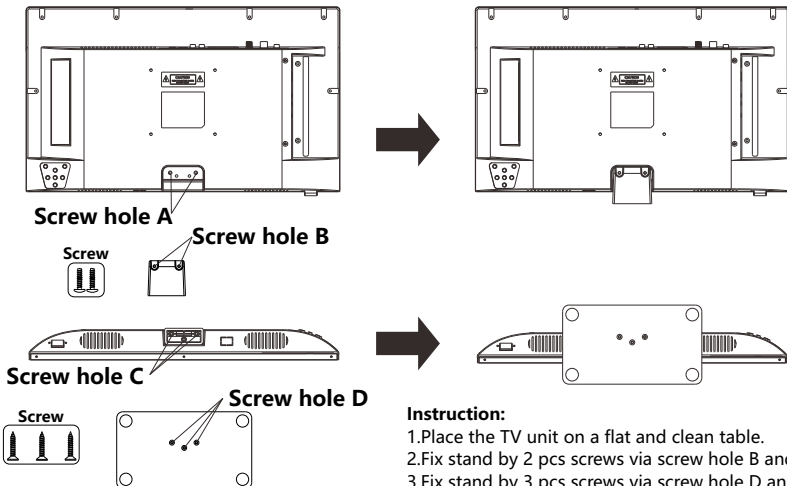

- Instruction:**
1. Place the TV unit on a flat and clean table.
 2. Fix stand by 2 pcs screws via screw hole B and A.
 3. Fix stand by 3 pcs screws via screw hole D and C.







General Description

Overview of remote control



General Description

Overview of remote control

- 1. POWER:** Turn the TV on and off.
- 2.  :** Search function.
- 3. Digital Buttons(0-9, -):** Directly select channel with digital buttons.
- 4. SOURCE:** Press to open the input source list.
- 5. NETFLIX:** If network connects, press this key to view NETFLIX directly.
- 6. Google Play:** If network connects, press this key to view Google Play directly.
- 7. YouTube:** If network connects, press this key to view YouTube directly.
- 8. Prime Video:** If network connects, press this key to view Prime Video directly.
- 9. HOME:** Display the HOME page.
- 10. Arrow button     :** Use to select on-screen menu items and change menu values.
- 11. MENU:** Display the main menu or exit the current menu.
- 12. OK:** Confirms selection.
- 13. BACK:** Return to the previous menu.
- 14. MUTE:** Press this button to cut off the sound of the TV set temporarily, press again to resume.
- 15. EXIT:** Exit the menu.
- 16. VOL +/- :** Press these buttons to adjust the volume.
- 17. COLOR BUTTONS:** It's used in the APPS.
 : Open/close in DVD mode.
- D.MENU:** Quick navigation during Teletext or setup settings / DVD: Video DVD Menu button.
- SETUP:** DVD system setup.
- D.DISP:** Quick navigation during Teletext or setup settings / DVD: DVD Information button.

General Description

Overview of remote control

- 18. CHA/V:** Press these buttons to change channel upward or downward.
- 19. GUIDE:** Select electronic program guide, in DTV mode, it will display all the information of program in a week when pressing this button.
- 20. DIGITAL MEDIA PLAYER CONTROL BUTTON:** Include backward, forward, play/pause, stop in USB mode. In DTV mode, press  button to record the TV program. Please refer to relevant instructions in the section of multimedia player.
- 21. LIST:** Press to display the channel list.
- A-B:** Press the A-B button once to set point A. Press the A-B button a second time to set point B. After setting the program repeat playing from A to B. Pressing the A-B button a third time will cancel the repeat.
- 22. TEXT:** Press to select the teletext mode.
- REPEAT:** DVD: Repetition mode button.
- 23. AUDIO:** Press to select mono, nicam, stereo for ATV channel, audio language for DTV channel.
- 24. SUBT:** Open or close subtitle.
- TITLE:** Press this button to return to the title of the disc.

General Description

Installing Batteries in the Remote Control

Installing Batteries

- 1 Open the battery compartment cover on the back side.

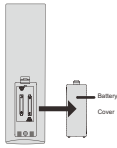

- 2 Insert two 1.5V AAA size batteries in correct polarity. Don't mix old or used batteries with new ones.

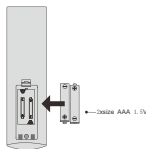

- 3 Closed the cover.

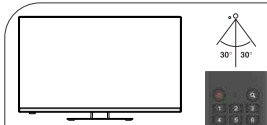
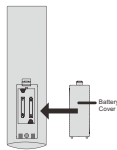

✦ Point the remote towards the remote control sensor of the wireless TV and use it within 7 meters.

✦ Put the used batteries into the recycling bin since it can negatively affect the environment.

Note:

- One loading of batteries will last for 1 year under normal use
- If you do not intend to use the remote controller for a long period of time, remove them to avoid damage due to leakage.
- Do not use old and new batteries together.
- The battery (battery or batteries or battery pack) shall not be exposed to excessive heat such as sunshine, fire or the like.

External Connection

Antenna connection

Antenna input impedance of this unit is 75ohm. VHF/UHF 75ohm coaxial cable can be connected to the antenna jack directly, if the antenna cable is 300ohm parallel flat feeder cable, you need to use the 300ohm/75ohm converter to connect the antenna cable to the antenna jack. For details Please refer to the following drawing.

Antennas with 300ohm flat twins Leads

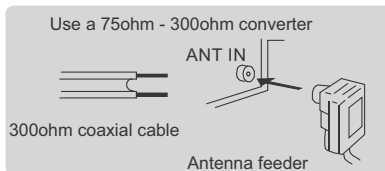

Antennas with 75ohm Round Leads

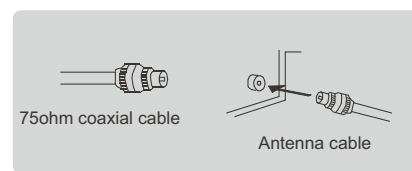

External Connection

Connecting DVD Player/Set-Top Box via HDMI

This connection can only be made if there is a HDMI Output connector on the external device.

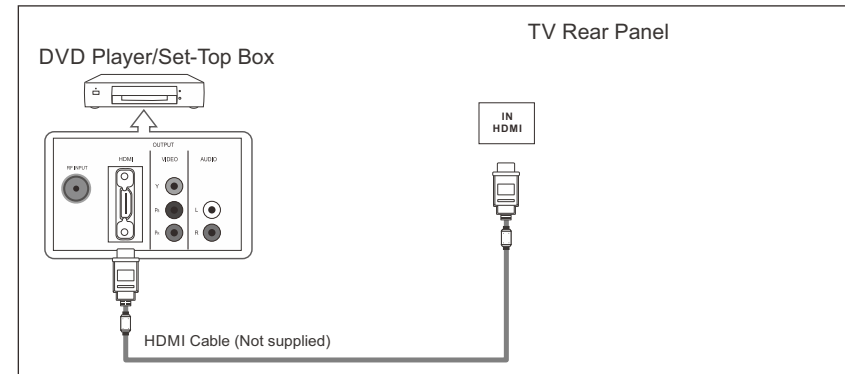

What is HDMI?

HDMI, or high-definition multimedia interface, is a next-generation interface that enables the transmission of digital audio and video signals using a single cable without compression.

Multimedia interface is a more accurate name for it especially because it allows multiple channels of digital audio (5.1 channels).

The difference between HDMI and DVI is that the HDMI device is smaller in size, has the HDCP(High Bandwidth Digital Copy Protection) coding feature installed, and supports multi-channel digital audio.

Each DVD player/STB has a different back panel configuration.

We recommend the use of cables with a Ferrite Core.

1. Connect an HDMI Cable between the HDMI connector on the TV and the HDMI connector on the DVD player/Set-Top Box.

External Connection

Connecting EARPHONE

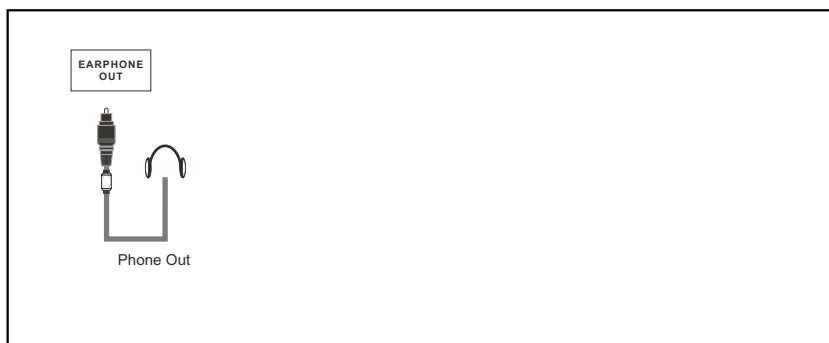

1. Plug EARPHONE out connector into EARPHONE out jack on the TV the TV speaker will be muted.

Supporting signals

Input	Resolution	Vertical Frequency
Component	480p	60Hz
	720p	60Hz
	1080i	60Hz
	1080p	60Hz
HDMI	480p	60Hz
	720p	60Hz
	1080i	60Hz
	1080p	60Hz

Basic Operation

Turning the TV On and Off

How to turn the TV on or off

1. Insert the power cord plug into a polarized DC outlet.
2. Press **POWER** button on the remote control or **⏻** button on the LED TV.
3. Normal picture will be displayed on the screen after 6 seconds. If no signal input, "No Signal" will be displayed on the screen.
4. If temporary **POWER** off is required, press **POWER** button on the remote control or **⏻** button on the LED TV.
5. Press and hold the power button for 6 seconds to completely turn off this device, after which you may choose to power it off or restart the TV, or you can unhook the unit's power cord plug.
6. After switching off the device, you should turn on the TV again at least 5 seconds later.

Status indication lamp

- White: standby mode.
- Transparent: power on mode.

Auto power-off

If there is no signal input in any Mode, the TV will automatically access the standby state in about 15 minutes.

Memory before turning TV off

The settings of picture and the preset channels will be memorized at turning off the unit. When being started up again, the unit will work according to the mode set before being turned off.

OSD Menu Operations

INITIAL SETUP

This function is used for the remote control pair code. After the code is successful, you can use the Bluetooth remote control to operate the TV.

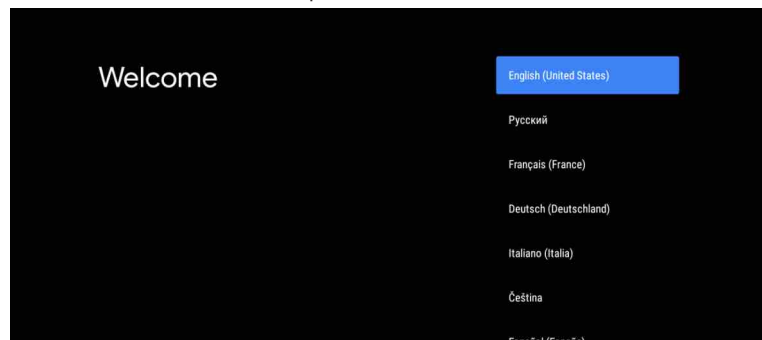

Press ▲/▼ to select the system language and press OK to confirm the language.

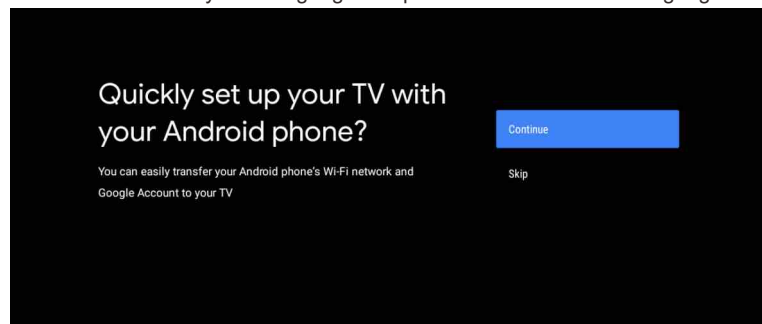

OSD Menu Operations

Connect your Android phone to your TV, select "Continue" to continue the connection, and choose "Skip" to skip this step.

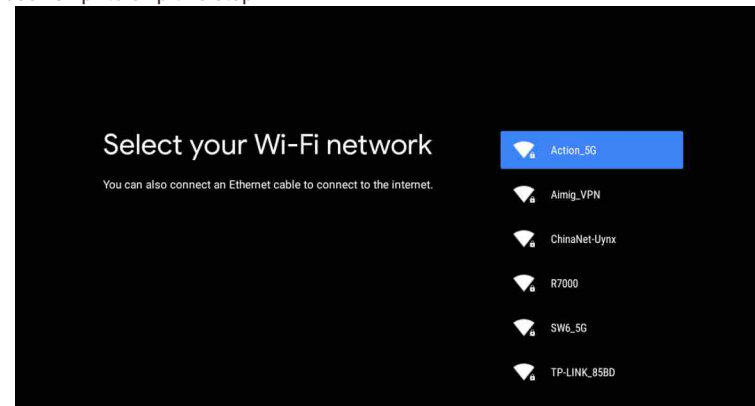

Press ▲/▼ to select the wifi to connect, press OK and enter the password to confirm the connection is successful.

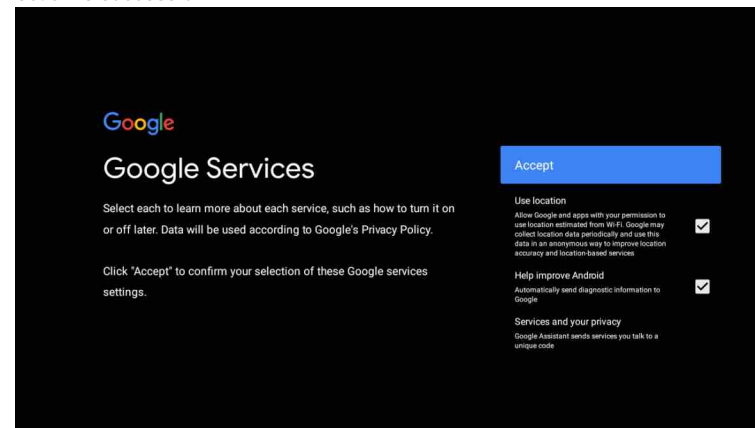

By agreeing to automatically send diagnostic information to Google to improve discriminative power, choose "YES" to accept.

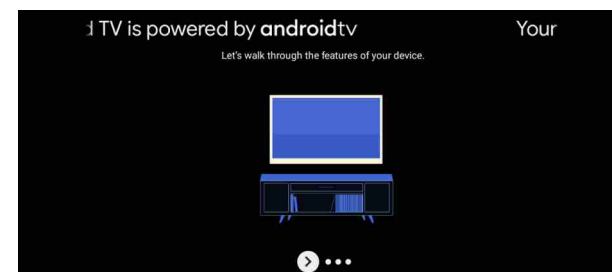

OSD Menu Operations

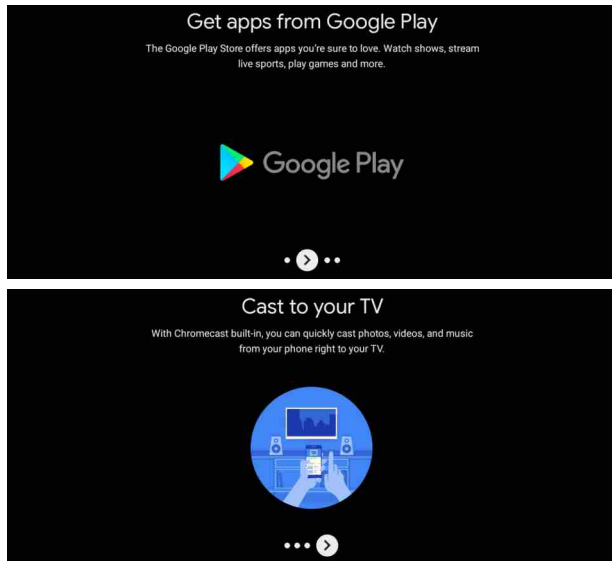

1. Your device is powered by Android TV and press the ► button to select the browsing feature.
2. You can get more apps from Google Play and press the ► button to go to the next screen.
3. Transfer photos and other content to the TV via the built-in chromecast, press OK to complete the browsing.

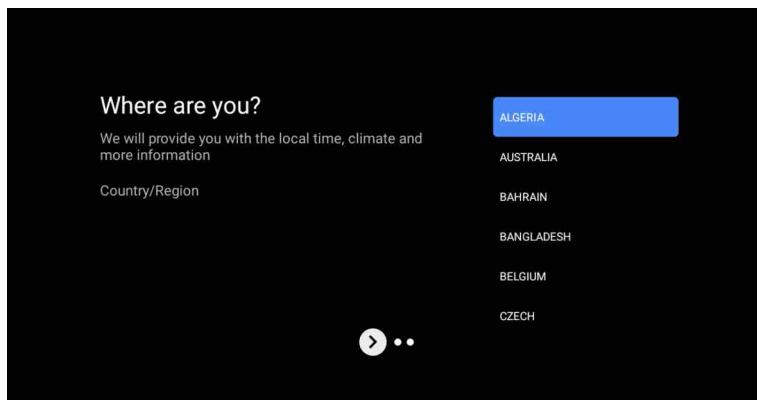

Press ▲/▼ to select the country of your device and press OK to confirm.

OSD Menu Operations

HOME SCREEN

After completing the wizard Settings, you can watch TV and go to the home screen.

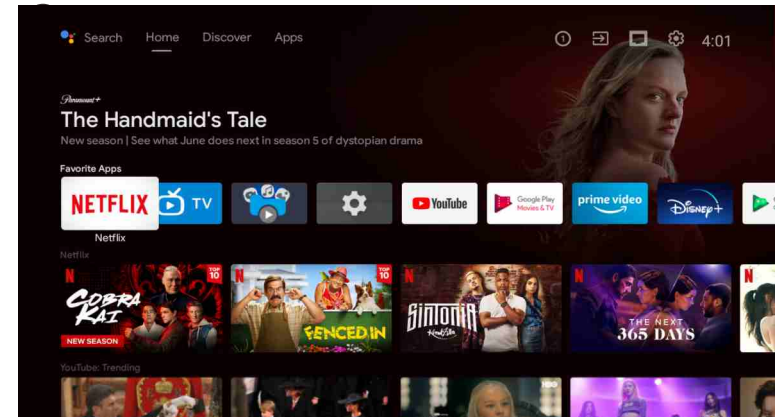

1. Open Google Assistant or start a text search.
 2. Among the applications installed on the TV, the icons for the favourite applications are shown inside here. (Favourite applications can be added/ deleted/changed its order by users.)
- 📺 Inputs: Icon to select an input source.
 - ⚙️ Settings: Various settings can be configured here. For details on the settings, see the next explanation.

INPUT SOURCE

In the HOME interface, press ▲/▼/◀/▶ to select the "Inputs" icon, press OK to open the input source list, then press up to highlight an input and press OK to switch.

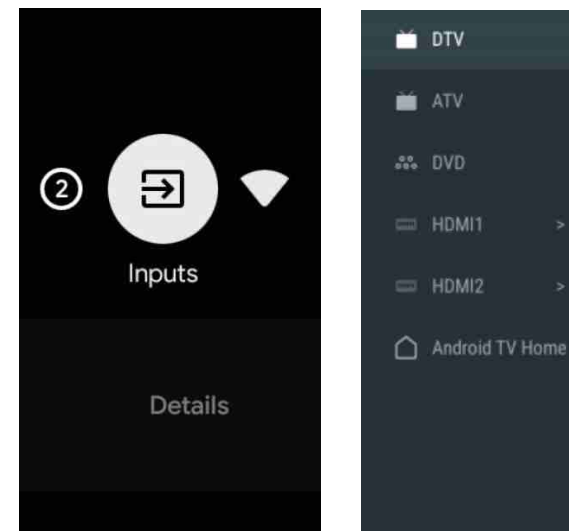

OSD Menu Operations

Under live TV, press the SOURCE button to display the list of input sources. You can select the desired source.

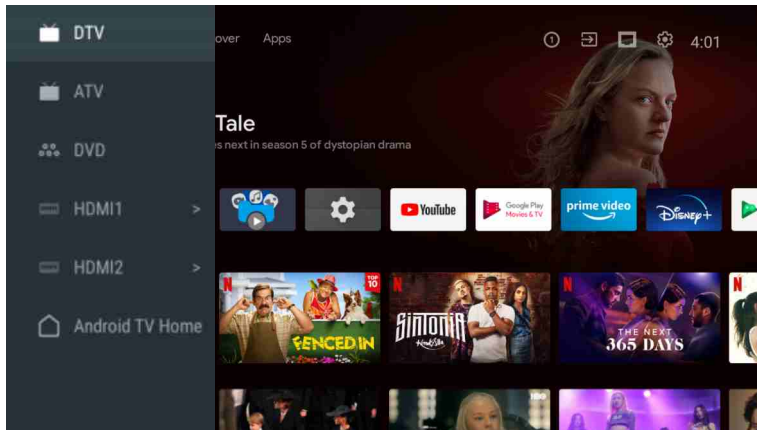

NAVIGATING THE ON-SCREEN MENU

1. In the HOME interface, press the ► key to select the icon of the circular settings menu, press OK to confirm.

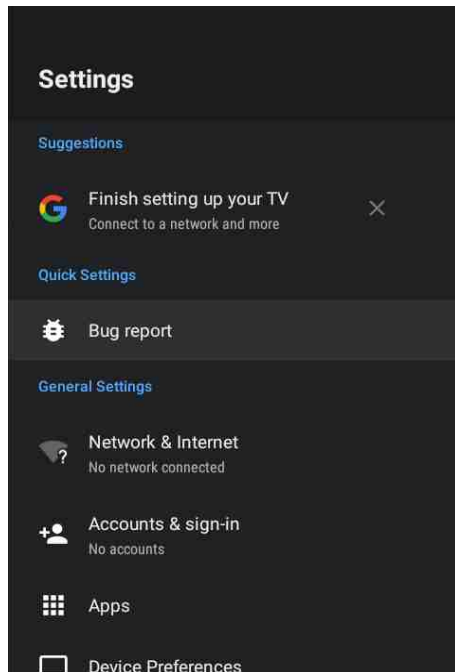

2. Press ▲/▼ button to select what you want set.
3. Press OK to enter setting.

OSD Menu Operations

Network

1 Press ▲/▼ button to select what you want set.
2. press OK button to adjust.
3. After finishing your adjustment, press OK button to save and return to the previous menu.

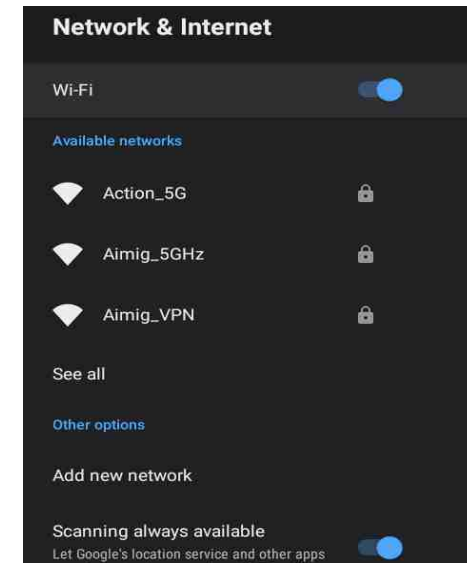

APPS

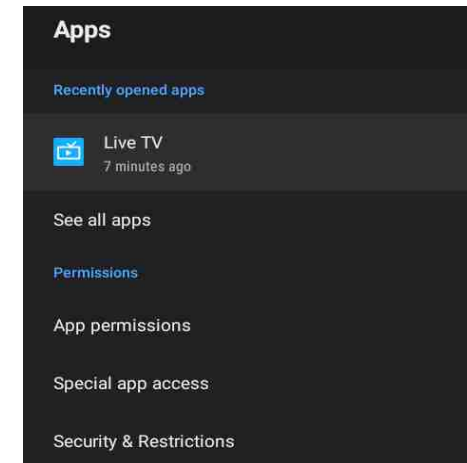

In this menu, you can set the APP permissions, and read the app lists.

1. Press ▲/▼ button to select what you want set.
2. Press OK button to adjust.
3. After finishing your adjustment, press BACK button to return to the previous menu.

OSD Menu Operations

DEVICE PREFERENCES ABOUT

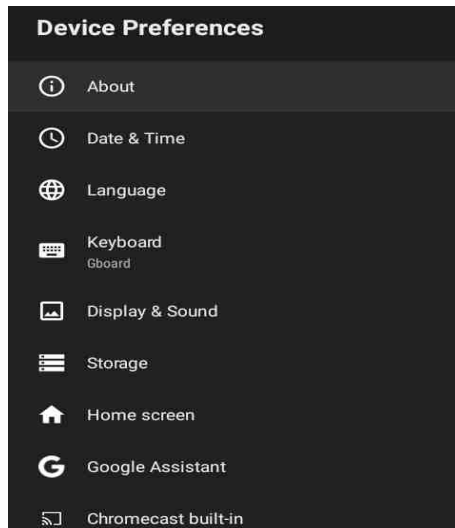

In this menu, you can read the information and settings of TV.

1. Press ▲/▼ button to select what you want set.
2. Press OK button to adjust.
3. After finishing your adjustment, press BACK button to return to the previous menu.

OSD Menu Operations

DATE & TIME

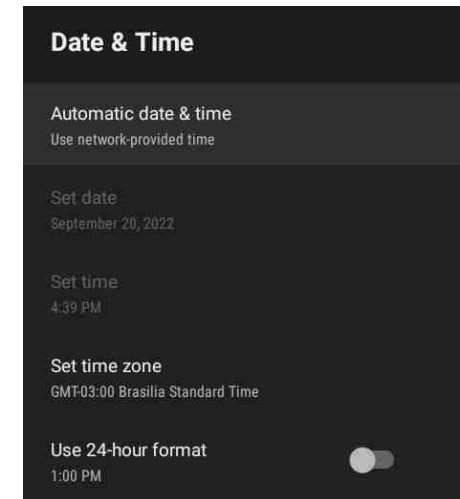

Automatic date & time- Press ▲/▼ button to select the option then press OK button to enter the sub-menu. (Optional: Use network-provided time, Off)

- Manually adjusting date & time settings will automatically change the Automatic date & time to OFF.

Set date- Press ▲/▼ button to select the option then press OK button to enter the sub-menu.

Set time- Press ▲/▼ button to select the option then press OK button to enter the sub-menu.

Set time zone- Press ▲/▼ button to select the option then press OK button to enter the sub-menu.

Use 24-hour format- Press ▲/▼ button to select the option then press OK button to choose ON/OFF.

OSD Menu Operations

LANGUAGE

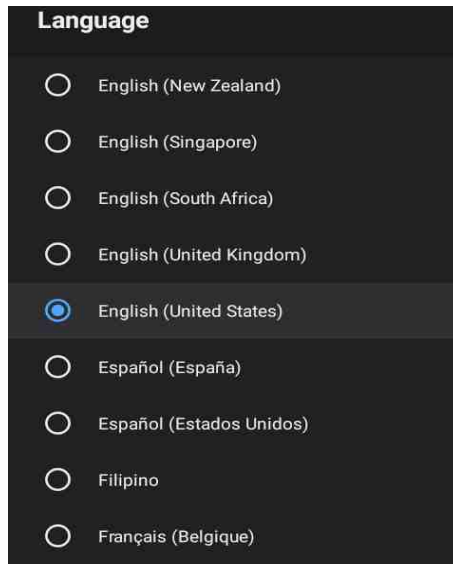

Language- Press ▲/▼ button to select the option then press button to enter the OK select language.

KEYBOARD

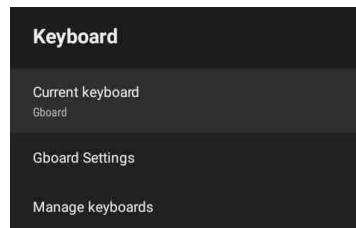

Current keyboard- Press ▲/▼ button to select the option then press OK button to enter the sub-menu.

Gboard Settings- Press ▲/▼ button to select the option then press OK button to enter the sub-menu.

Manage keyboards- Press ▲/▼ button to select the option then press OK button to enter the sub-menu.

OSD Menu Operations

STORAGE

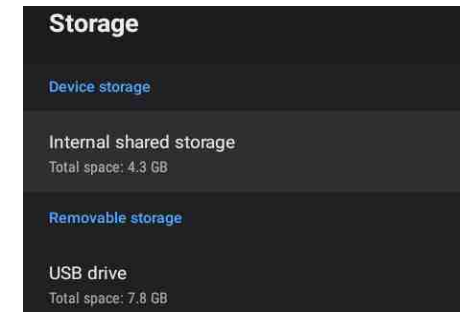

Internal shared storage- Press ▲/▼ button to select the option then press OK button to enter the sub-menu.

Removable Storage- Press ▲/▼ button to select the option then press OK button to enter the sub-menu.(Note: Show external devices if available)

HOME SCREEN

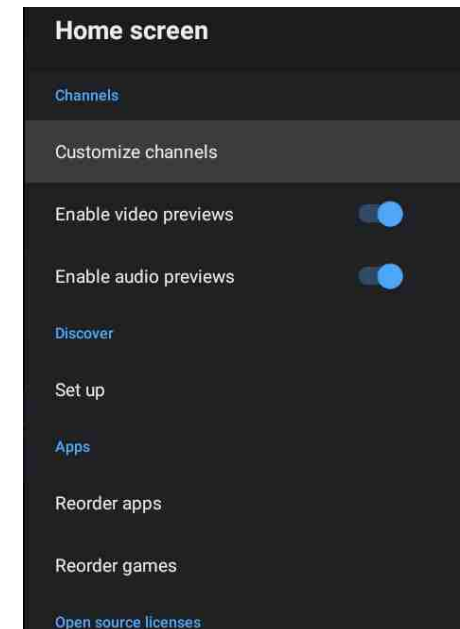

In this menu, you can set channels, apps, open source licenses.

1. Press ▲/▼ button to select what you want set.

2. Press OK button to adjust.

3. After finishing your adjustment, press BACK button return to the previous menu.

OSD Menu Operations

GOOGLE

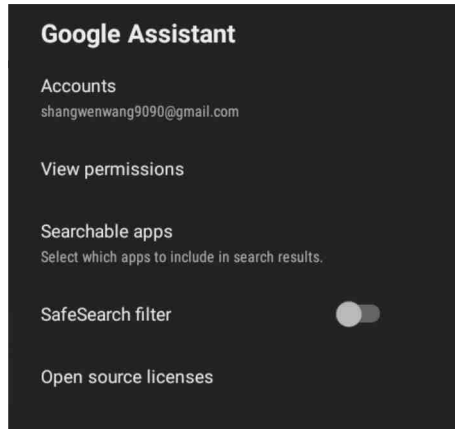

In this menu, you can set searchable apps, safe search filter, block offensive words, open source licenses.

1. Press ▲/▼ button to select what you want set.
2. Press OK button to adjust.
3. After finishing your adjustment, press BACK button return to the previous menu.

CHROMECAST BUILT-IN

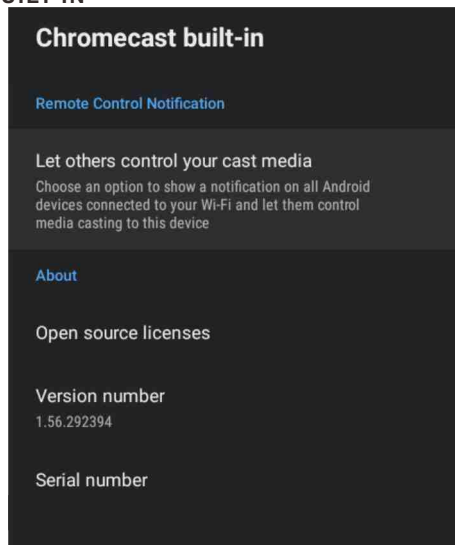

In this menu, you can read the information and settings of Chromecast.

1. Press ▲/▼ button to select what you want set.
2. Press OK button to adjust.
3. After finishing your adjustment, press BACK button return to the previous menu.

OSD Menu Operations

SCREEN SAVER

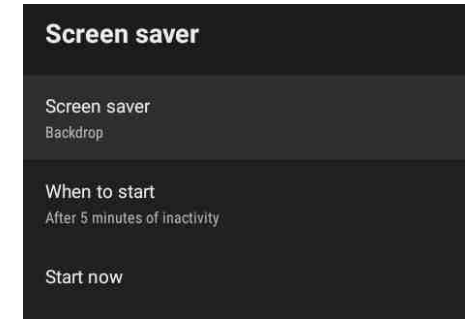

Screen saver- Press ▲/▼ button to select the option then press OK button to enter the sub-menu. (Optional: Turn screen off, Backdrop, Colors)

When to Start- Press ▲/▼ button to select the option then press OK button to enter the sub-menu. (Optional: 5 minutes, 15 minutes, 30 minutes, 1 hour, 2 hours.)

Start now- Press ▲/▼ button to select the option then press OK button to enter screen saver.

ENERGY SAVER

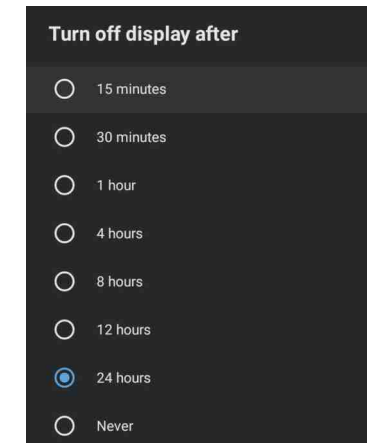

Turn off Display- Press ▲/▼ button to select the option then press OK button to enter the sub-menu. (Options: 15 minutes, 30 minutes,24 hours, Never.)

Media Menu Operations

LOCATION

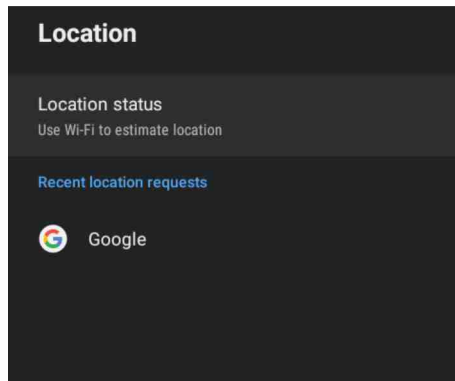

Location status- Press ▲/▼ button to select the option then press OK button to enter the sub-menu. (Optional: Use Wi-Fi to estimate location, Off)

USAGE & DIAGNOSTICS

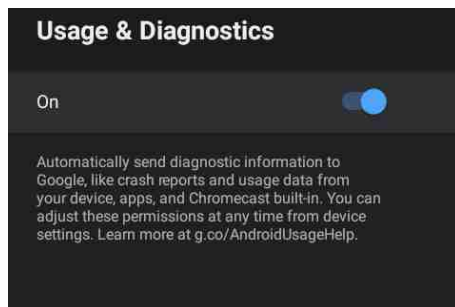

Usage & diagnostics- Press ▲/▼ button to select the option then press button OK to choose ON/OFF.

OSD Menu Operations

ACCESSIBILITY

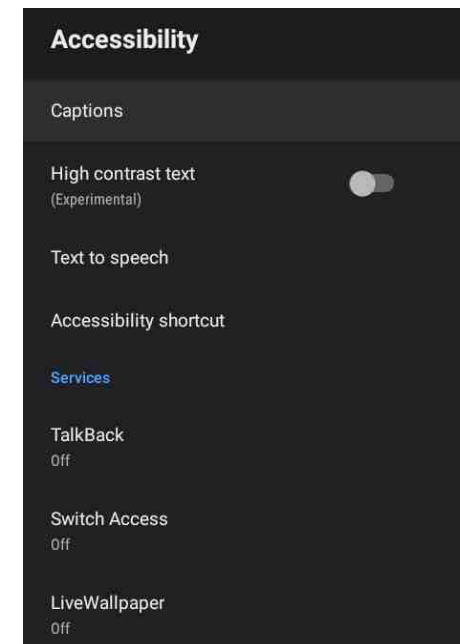

Captions- Press ▲/▼ button to select the option then press OK button to enter the sub-menu.

High contrast text- Press ▲/▼ button to select the option then press OK button to choose ON/OFF.

Text to speech- Press ▲/▼ button to select the option then press OK button to enter the sub-menu.

Accessibility shortcut- Press ▲/▼ button to select the option then press OK button to choose ON/OFF.

TalkBack- Press ▲/▼ button to select the option then press OK button to enter the sub-menu.

Switch Access- Press ▲/▼ button to select the option then press OK button to enter the sub-menu.

OSD Menu Operations

RESTART

Press OK button to enter the sub-menu.
Restart the TV.

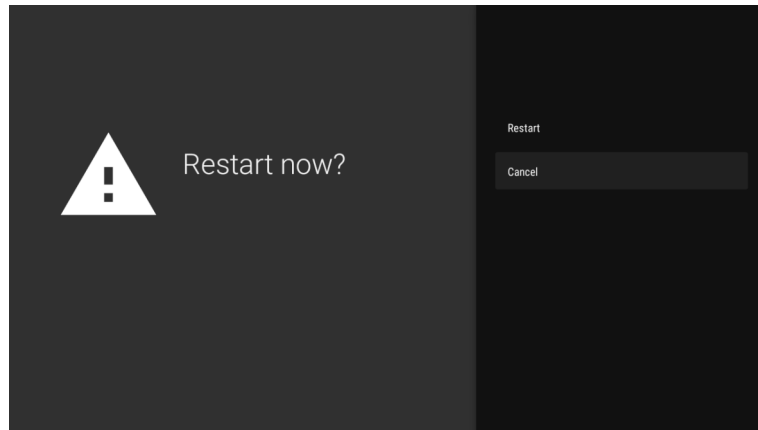

OSD Menu Operations

ADD AND USE OF MEDIA PLAYER

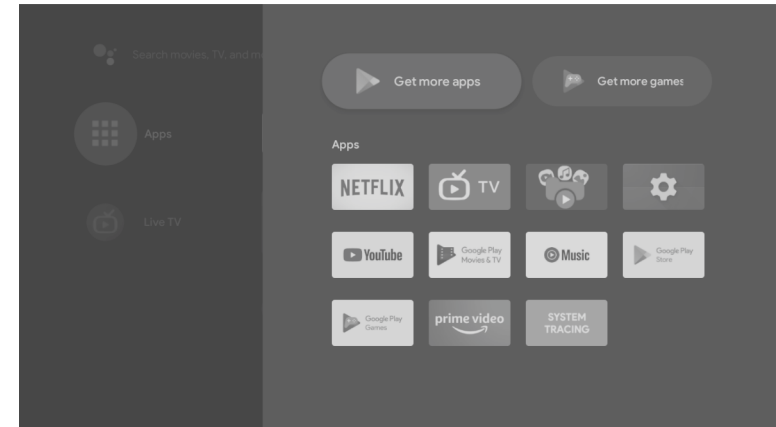

1. In the HOME interface, select the + icon in the APP column to add the application, and click OK.

Press up and down to select the Media Player application, and click to add it OK to the HOME interface.

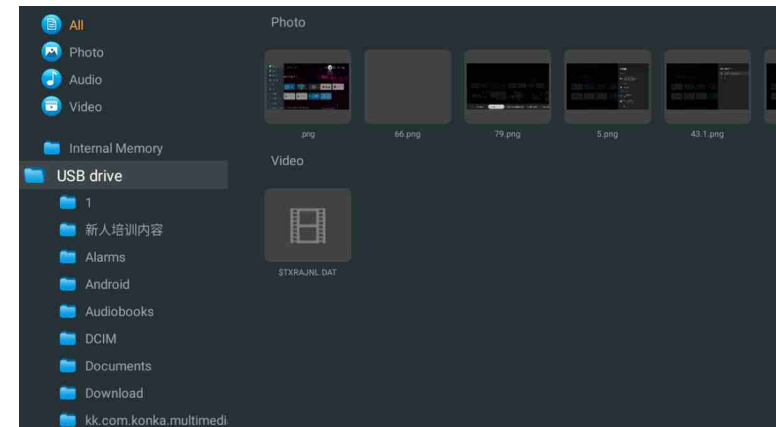

2. Focus on the corresponding USB driver and press OK to display video, photo, audio files.

Press navigation button to select the file.

OSD Menu Operations

PICTURE

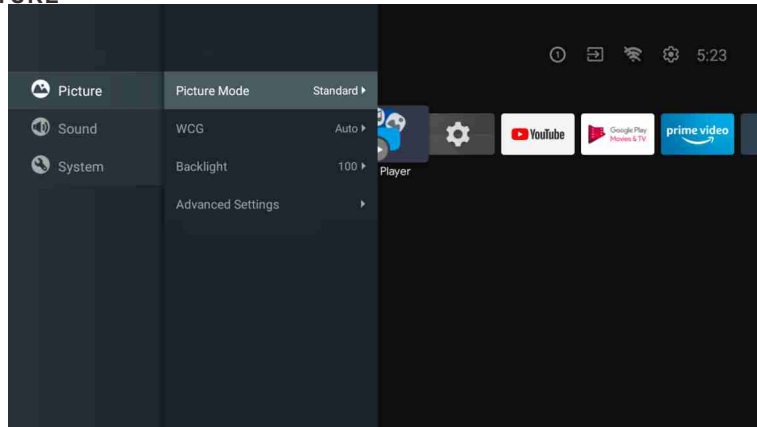

Picture Mode- Press ▲/▼ button to select the option button to enter the sub-menu. (Optional: Standard, Dynamic, Movie, Eye Comfort, Gentle, Vivid, Sport, Personal).

Brightness/Color Saturation/Hue/Contrast/Gamma/Black Level Sharpness- Press ▲/▼ button to select the option.

Press ◀ to decrease the parameter. Press ▶ to increase the parameter.

Gamma- Press ▲/▼ button to select the option.

Press ◀ to decrease the parameter.

Press ▶ to increase the parameter.

ECO

Press MENU key to the main menu, and select Picture.

Press button to ECO option and press OK to select the option.

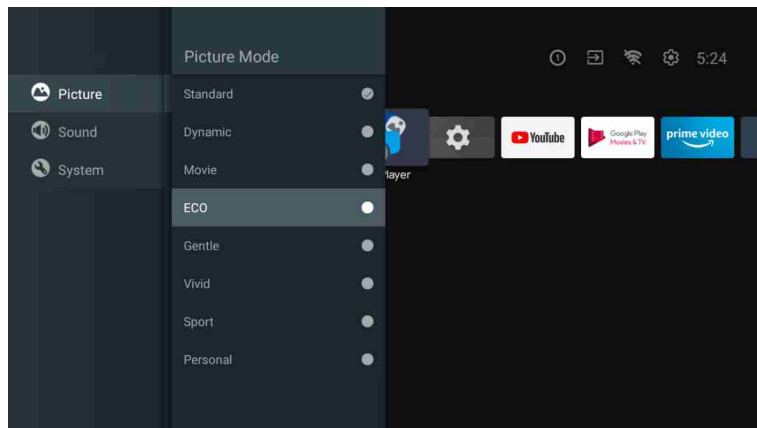

OSD Menu Operations

SOUND

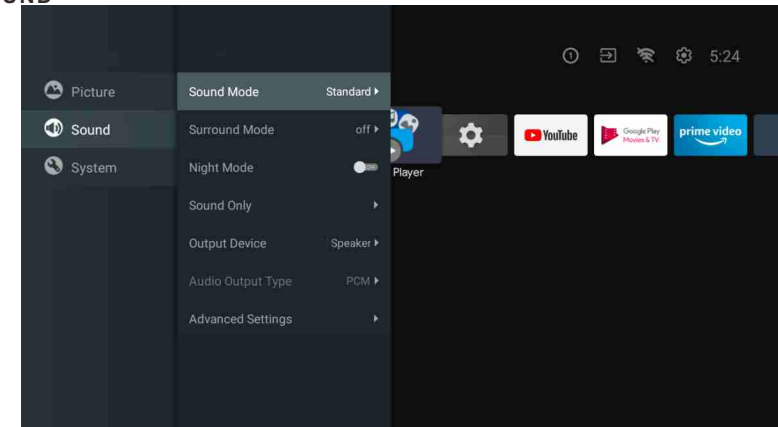

Press MENU key to the main menu, and select Sound.

Sound Mode- Press OK to enter the sub-menu, press button to select option and press OK to select the option.

Pure Sound- Press ▲/▼ button to select the option then press OK button to choose ON/OFF.

Surround- Press ▲/▼ button to select the option then press OK button to choose ON/OFF.

Sound Only- Press OK to enter the sub-menu, press OK button to select option.

Output Device- Press ▲/▼ to enter the sub-menu.

Audio Output Type- Press ▲/▼ to enter the sub-menu.

Advanced Settings- Press ▲/▼ to enter the sub-menu.

SYSTEM

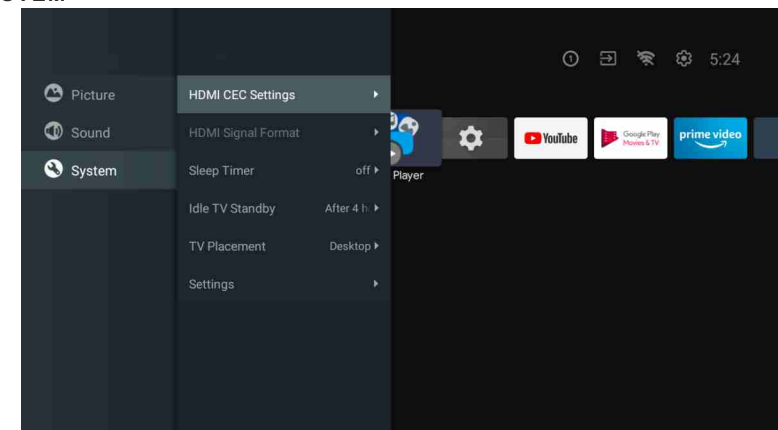

Press MENU key to the main menu, and select System.

Press ▲/▼ button to select option and press OK to select the option.

OSD Menu Operations

Media

Media Player

Movie

on Media Player menu, move cursor to movie, press [OK] button to enter into FileSelector menu. Select the file you want to play, press [PLAY/PAUSE] to enter into full screen play. Press [LEFT]/[RIGHT] button to move cursor, and operate according to different hint.

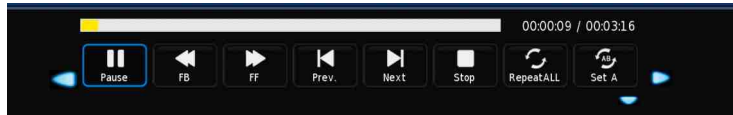

Music

In the same way, on Media Player menu, move cursor to Music, press [OK] button to enter into FileSelector menu. Select the file you want to play, press [PLAY/PAUSE] to enter into full screen play. Press [LEFT]/[RIGHT] button to move cursor, and operate according to different hint.



Photo

In the same way, on Media Player menu, move cursor to Photo, press [OK] button to enter into FileSelector menu. Select the file you want to play, press [PLAY/PAUSE] to enter into full screen play. Press [LEFT]/[RIGHT] button to move cursor, and operate according to different hint.

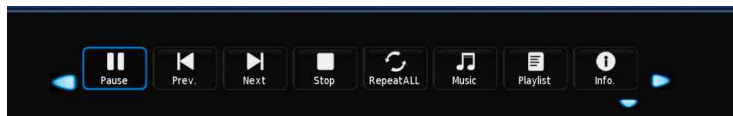

DVD

SOURCE

Press the "SOURCE" button menu, through the up and down direction keys can be select, Press the left or right button to select the DVD, and press the Enter button to enter. Press the DVD SETUP button to enter.

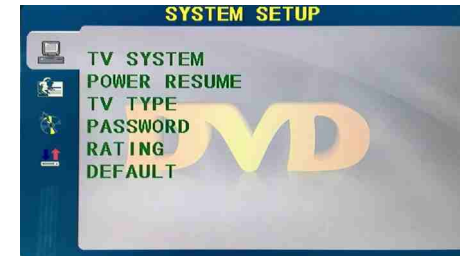

TV SYSTEM

Set the options are: NTSC/PAL/AUTO.

POWER RESUME

Press the ENTER function on or off with.

TV TYPE

Set the screen ratio options are: PS(4:3 Pan Scan), Normal/PS(4:3 Letter Box), and Wide (16:9)the default settings is wide.

PASSWORD

Enter "0000" to enter.

RATING

Level Disc Options.

DEFAULT

This option will return the DVD to it's factory default settings.



OSD LANGUAGE

Set the OSD Language options.

AUDIO LANG

DVD language selection options.

SUBTITLE LANG

This player can display DVD subtitle languages if supported by the DVD disc. when playing DVD's you can hide the subtitle or choose any of them as the current subtitle language.

MENU LANG

Set the MENU Language options.

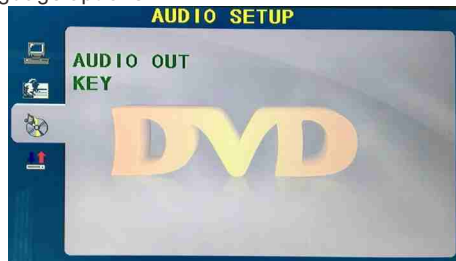

AUDIO OUT

Press the "ENTER" Key enter, through the up and down direction keys can be select.

KEY

Press the "ENTER" Key enter, through the up and down direction keys can be select.



DUAL MONO

Press the "ENTER" Key enter, through the up and down direction keys can be select.

If you have any problem, check the countermeasures for each symptom listed below. The following symptoms may have caused by inappropriate adjustment rather than actual malfunction of the unit. If the trouble persists, contact the service center.

Symptoms	Possible solutions
No power	Disconnect the power cord, wait 60 seconds then reconnect the power cord and restart the TV.
No picture	Check antenna connection. Station may experience problems, please tune to another station. Please adjust the settings of contrast and brightness.
Good picture but no sound	Increase the volume. please check sound settings.
Good sound but abnormal color or no picture	Check the antenna connection.
No remote control	No support for this function.
Full screen flickering under VGA	V-HEIGHT value may be set too big, restart computer and enter safe mode, then set monitor parameters to correct value according to adjustment description.
Horizontal stripes under VGA	Sample phase may be deflected, adjust phase according to picture position.
Colored dots may be present on the screen	This product is the high resolution LED display device and a few cell defects can occur in the manufacture of the LED. Several colored dots visible on the screen would be acceptable. in line with other LED manufacturers and would not mean that the LED is faulty. We hope you will understand that it could not be changed or refunded.

Picture defects and the reason



Snowy Picture

Snowy picture is usually due to weak signal. Adjust antenna or install an antenna amplifier.



Double Image or Ghosts

Double images are usually caused by reflections from tall buildings. Adjust the direction of the antenna or raise it.



Radio Wave Interference

Wave patterns are moving on the screen, which are usually caused by nearby radio transmitters or short-wave receiving equipment.



High Temperature Electrothermal Interference

Diagonal or herringbone patterns appear on the screen or part of picture is missing. This is probably caused by high temperature electrothermal equipment in a nearby hospital.