

ENGLAON



Waterproof Smart TV

USER'S MANUAL

Scan to download the Manual

For support please contact our service department at service@englaon.com.au

Safety Information

IMPORTANT SAFETY INSTRUCTIONS

Read these instructions.
Keep these instructions.
Heed all warnings.
Follow all instructions.
Do not use this apparatus near water.
Clean only with dry cloth.
Do not block any ventilation openings. Install in accordance with the manufacture's instructions.
Do not install near any heat sources such as radiators, heat registers, stoves, or other apparatus (including amplifiers) that produce heat.
Do not defeat the safety purpose of the polarized or grounding plug. A polarized plug has two blades with one wider than the other. A grounding plug has two blades and a third grounding prong. The wide blade or the third prong is provided for your safety. If the provided plug does not fit into your outlet, consult an electrician for replacement of the obsolete outlet.
Protect the power cord from being walked on or pinched particularly at the plugs, convenience receptacles, and at the point where they exit from the apparatus.
Only use attachments/accessories specified by the manufacturer.
Use only with the cart, stand, tripod, bracket, or table specified by the manufacturer, or sold with the apparatus. When a cart or rack is used, use caution when moving the cart/apparatus combination to avoid injury from tip-over.



S3125A

Unplug the apparatus during lightning storms or when unused for long periods of time.
Refer all servicing to qualified personnel. Servicing is required when the apparatus has been damaged in any way, such as power supply cord or plug is damaged, liquid has been spilled or objects have fallen into the apparatus has been exposed to rain or moisture, does not operate normally, or has been dropped.
CAUTION: These servicing instructions are for use by qualified service personnel only.
To reduce the risk of electric shock, do not perform any servicing other than that contained in the operating instructions unless you are qualified to do so.
WARNING : To reduce the risk of fire or electric shock, do not expose this apparatus to rain or moisture. The apparatus shall not be exposed to dripping or splashing and that objects filled with liquids, such as vases, shall not be placed on apparatus.
WARNING: The mains plug is used as disconnect device, the disconnect device shall remain readily operable.



- This lightning flash with arrowhead symbol within an equilateral triangle is intended to alert the user to the presence of non-insulated "dangerous voltage" within the product's enclosure that may be of sufficient magnitude to constitute a risk of electric shock.
- Warning: To reduce the risk of electric shock, do not remove cover (or back) as there are no user-serviceable parts inside. Refer servicing to qualified personnel.
- The exclamation point within an equilateral triangle is intended to alert the user to the presence of important operating and maintenance instructions in the literature accompanying the appliance.

Content

Safety Information	1
Content	2
TV Specification	3
Accessories	4
Overview of back panel	5
Installation instructions	6-7
Remote-Control unit	8-9
General Description	10
TV Operation	11-25
Troubleshooting	26-27

TV Specification

Screen size	24"
Display Type	TFT LED
Resolution	1920 X 1080
Aspect Ratio	16:9
Alimentation	DC 12V $\overline{\text{---}}$ 4A
Audio Output	L/R 5W X 2
Product Dimensions	594 X 396 X 54 mm

Hardware Configuration

CPU	ARM Cortex-A55 quad core
GPU	Mali G31MP2
DDR SIZE	1.5 GB
eMMC Flash	8 GB

Note:

Design and specification modification maybe made at any time without prior notice, all data and dimensions are approximations.

Accessories

Please make sure the following items are included with your LED TV.
If any items are missing, contact your dealer.



Remote Control

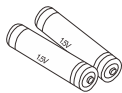

Batteries (AAx 2)

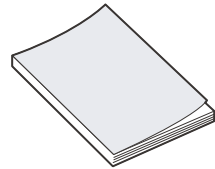

Owner's Instructions

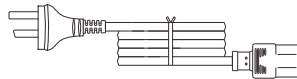

Power Cord



Adapter

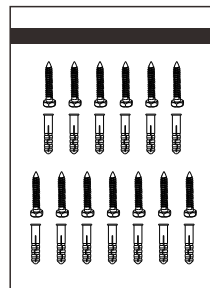

Fixed screw

Overview of back panel

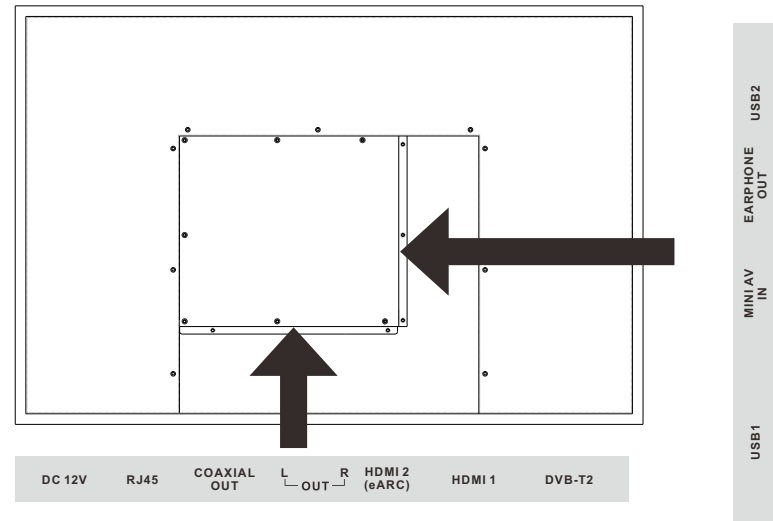

1. DC 12V
DV 12V input

2. RJ45
Ethernet connection for.

3. COAXIAL
Coaxial Digital audio output.

4. L/R
Connect to the audio output jacks on your amplifier/home theater.

5. HDMI 2(eARC)
Connecting for HDMI.

6. HDMI 1
Connecting for HDMI.

7. DVB-T2

Connected to external antenna to receive the ATV/DTV program in ATV/DTV mode.

8. USB 1
Connecting for USB signal.

9. MINI AV IN
Connecting for VIDEO signal input in Composite mode.

10. EARPHONE OUT
Connecting for headphone.

11. USB 2
Connecting for USB signal.

Installation instructions

PLEASE NOTE: installation of your TV should be carried out by a technical competent person and confirm to all relevant regulations. If in any doubt please contact us or a qualified electrician. Your warranty will be void if any problems are due to incorrect installation/poor sealing of the unit.

- 1.Ensure that you get the correct viewing position when installing your mounting plate. Once you have got the correct position check that there are no hazards around the area of installation, for example, cables or pipes.
- 2.Please use our Mounting plate TV sizes below to cut out a recess in the wall to fit into the wall depending on what TV size you have.
- 3.Unscrew the plate at the back of the TV and connect all required wire connection from the wall, through the square cable hole to the TV, then screw back the plate securely ensure all the connected wires are going through the square cabling hole are not pinched or broken .
- 4.Fix your mounting plate into place with the screws provided.
- 5.Once you have checked that the TV is functioning correctly and all cables are fitted, apply unbro-ken bead of silicon to the inside of the TV bezel at least 5mm thick.
- 6.Please ensure the bezel is firmly sealed to the wall surface to complete the waterproof properties of the installation. If it is not sealed correctly this will void your warranty.

Installation A - a recessed installable TV

1. Make a hole in the wall, and the size of the hole should not exceed the size of the Television (Please leave enough space for the cables)

2. Position the mounting plate

3. Fit the waterproof television

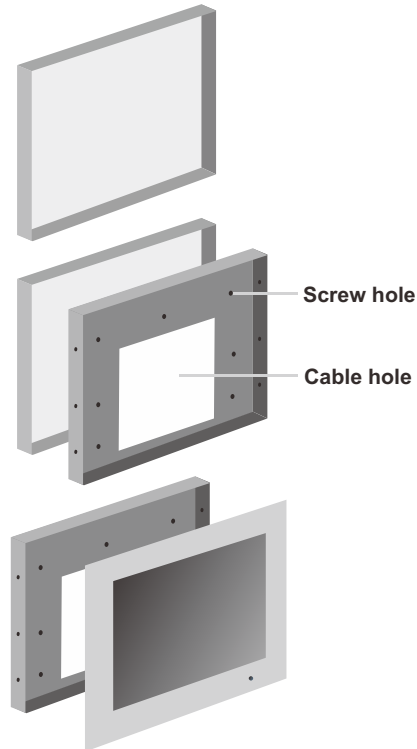

Installation instructions

Installation B - a wall-mounted installable TV (TV does not provide mounting brackets and wall screws) VESA: 200*200 MM

1. Mounting Bracket to Wall
Fix the horizontal bracket into wall with screws.

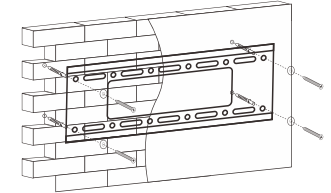

2. Mounting bracket to TV
Fix the vertical bracket on the back of TV with screws(M6).

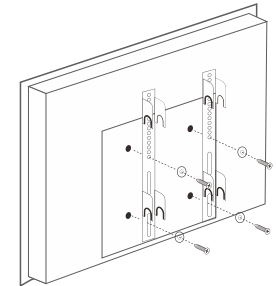

3. Mounting TV to Bracket.

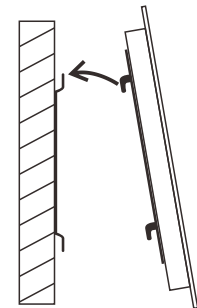

Remote-Control unit



1. **POWER:** Turn the TV on and off.
2. : Press to open the google assistant or start a voice search.
3. **Digital Buttons(0-9, -):** Directly select channel with digital buttons.
4. **SOURCE:** Press to open the input source list.
5. **NETFLIX:** If network connects, press this key to view NETFLIX directly.
6. **Google Play:** If network connects, press this key to view Google Play directly.
7. **YouTube:** If network connects, press this key to view YouTube directly.
8. **Prime Video:** If network connects, press this key to view Prime Video directly.
9. **HOME:** Display the HOME page.
10. **Arrow button ▲▼◀▶:** Use to select on-screen menu items and change menu values.
11. **MENU:** Display the main menu or exit the current menu.
12. **OK:** Confirms selection.
13. **BACK:** Return to the previous menu.
14. **MUTE:** Press this button to cut off the sound of the TV set temporarily, press again to resume.
15. **EXIT:** Exit the menu.
16. **VOL +/- :** Press these buttons to adjust the volume.
17. **COLOR BUTTONS:** It's used in the APPS.
18. **CH ^/v:** Press these buttons to change channel upward or downward.
19. **GUIDE:** Select electronic program guide, in DTV mode, it will display all the information of program in a week when pressing this button.
20. **DIGITAL MEDIA PLAYER CONTROL BUTTON:** Include backward, forward, play/pause, stop in USB mode. In DTV mode, press ● button to record the TV program. Please refer to relevant instructions in the section of multimedia player.
21. **LIST:** Press to display the channel list.
22. **TEXT:** Press to select the teletext mode.
23. **AUDIO:** Press to select mono, nicam, stereo for ATV channel, audio language for DTV channel.
24. **SUBT:** Open or close subtitle.

General Description

Installing Batteries in the Remote Control

Installing Batteries

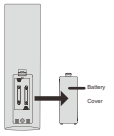
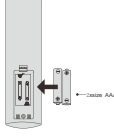
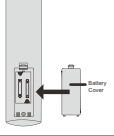
- 1 Open the battery compartment cover on the back side.
 
- 2 Insert two 1.5V AAA size batteries in correct polarity. Don't mix old or used batteries with new ones.
 
- 3 Closed the cover.
 

✦ Point the remote towards the remote control sensor of the wireless TV and use it within 7 meters.

✦ Put the used batteries into the recycling bin since it can negatively affect the environment.

NOTES:

- One loading of batteries will last for 1 year under normal use.
- If you do not intend to use the remote controller for a long period of time, remove them to avoid damage due to leakage.
- The batteries (battery pack or batteries installed) shall not exposed to excessive heat such as sunshine, fire or the like.

External Connection

Antenna connection

Antenna input impedance of this unit is 75ohm. VHF/UHF 75ohm coaxial cable can be connected to the antenna jack directly, if the antenna cable is 300ohm parallel flat feeder cable, you need to use the 300ohm/75ohm converter to connect the antenna cable to the antenna jack. For details Please refer to the following drawing.

Antennas with 300ohm flat twins Leads

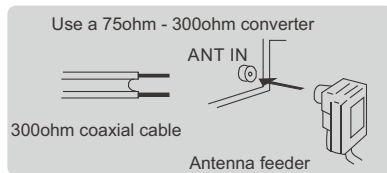

Antennas with 75ohm Round Leads

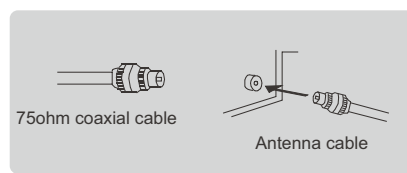

TV Operation

INITIAL SETUP

Press ▲/▼ to select the system language and press OK to confirm the language.

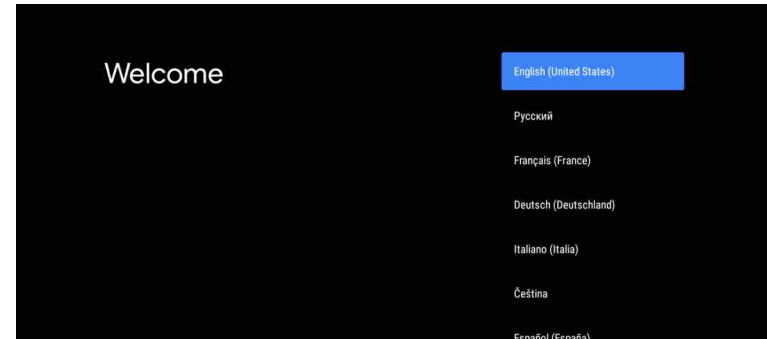

Connect your Android phone to your TV, select "Continue" to continue the connection, and choose "Skip" to skip this step.

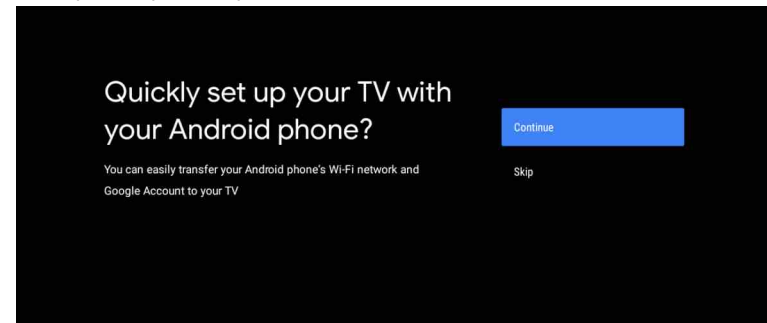

Connect your Android phone to your TV, select "Continue" to continue the connection, and choose "Skip" to skip this step.

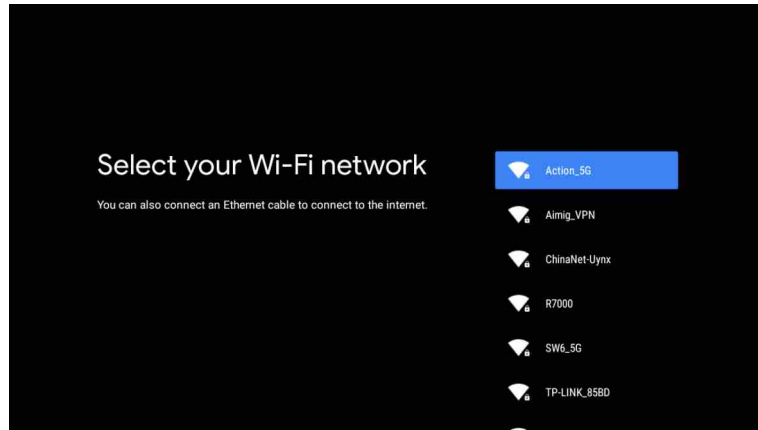

Press ▲/▼ to select the wifi to connect, press OK and enter the password to confirm the connection is successful.

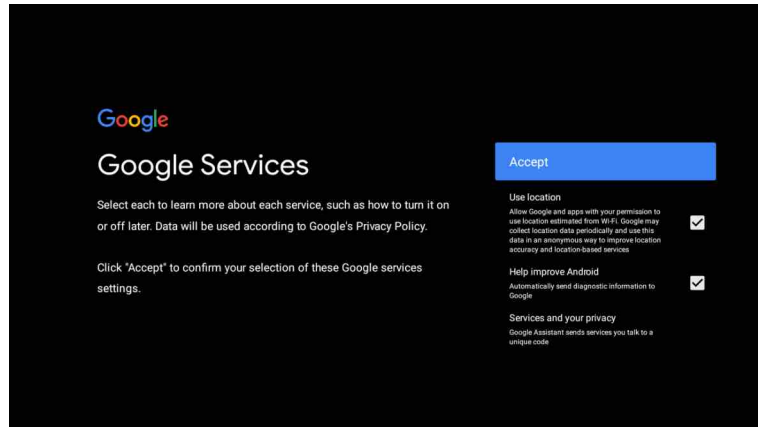

By agreeing to automatically send diagnostic information to Google to improve discriminative power, choose "YES" to accept.

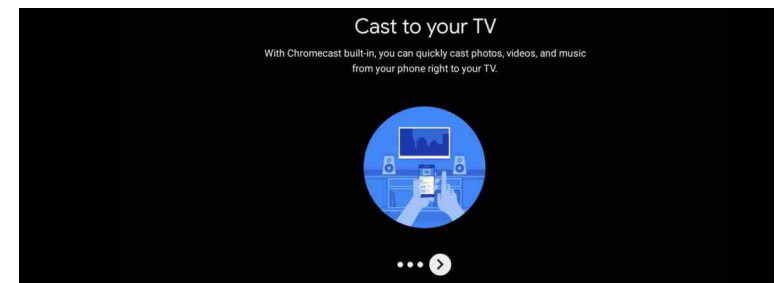
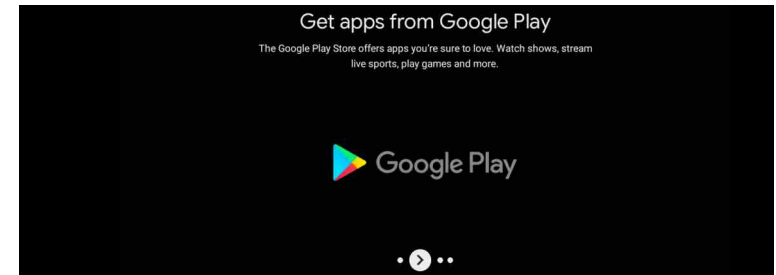
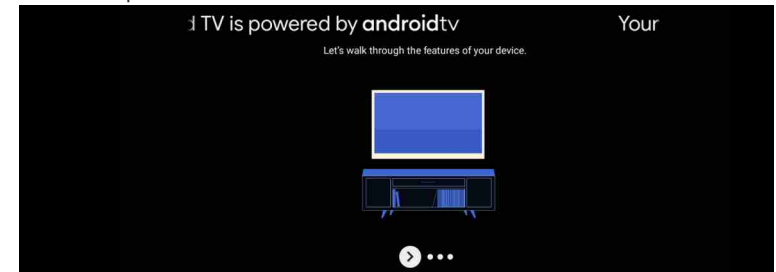

1. Your device is powered by Android TV and press the ► button to select the browsing feature.
2. You can get more apps from Google Play and press the ► button to go to the next screen.
3. Transfer photos and other content to the TV via the built-in chromecast, press OK to complete the browsing.

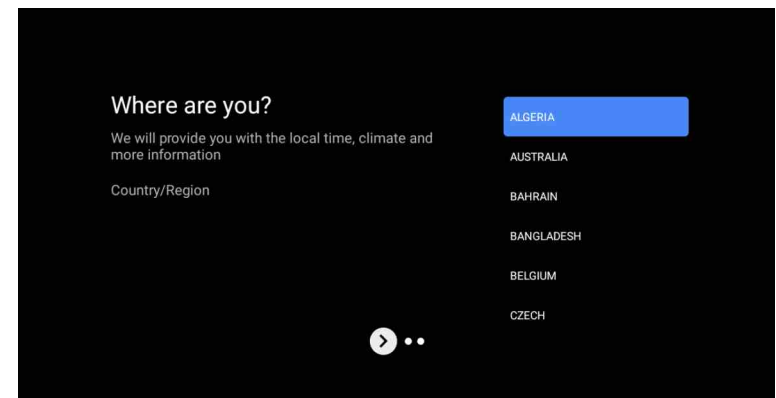

Press ▲/▼ to select the country of your device and press OK to confirm.

HOME SCREEN

After completing the wizard Settings, you can watch TV and go to the home screen.



1. Open Google Assistant or start a text search.
2. Among the applications installed on the TV, the icons for the favourite applications are shown inside here. (Favourite applications can be added/ deleted/changed its order by users.)

🔍 Inputs: Icon to select an input source.
⚙️ Settings: Various settings can be configured here. For details on the settings, see the next explanation.

INPUT SOURCE

In the HOME interface, press ▲/▼/◀/▶ to select the "Inputs" icon, press OK to open the input source list, then press up to highlight an input and press OK to switch.

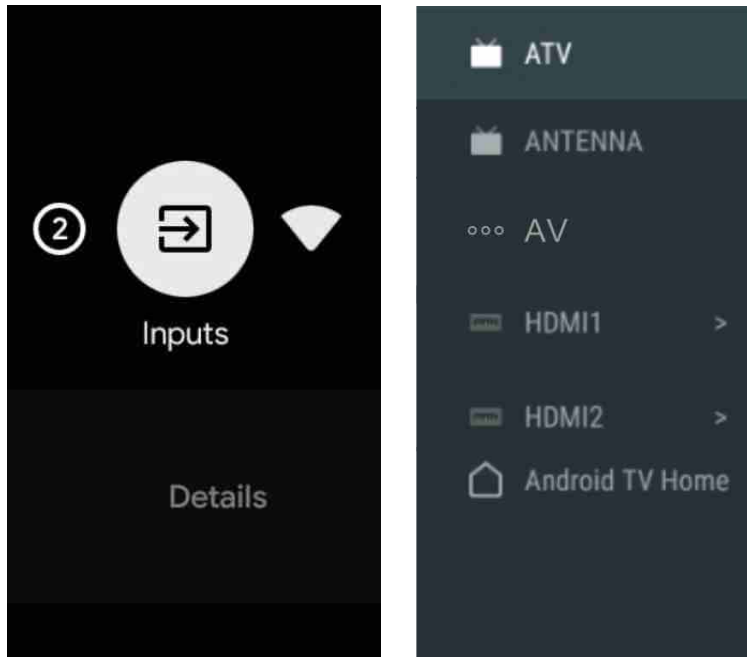

Under live TV, press the SOURCE button to display the list of input sources. You can select the desired source.

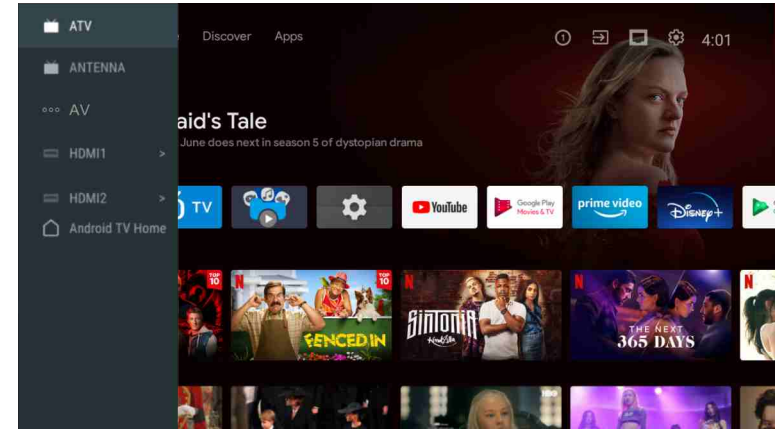

NAVIGATING THE ON-SCREEN MENU

1. In the HOME interface, press the ► key to select the icon of the circular settings menu, press OK to confirm.

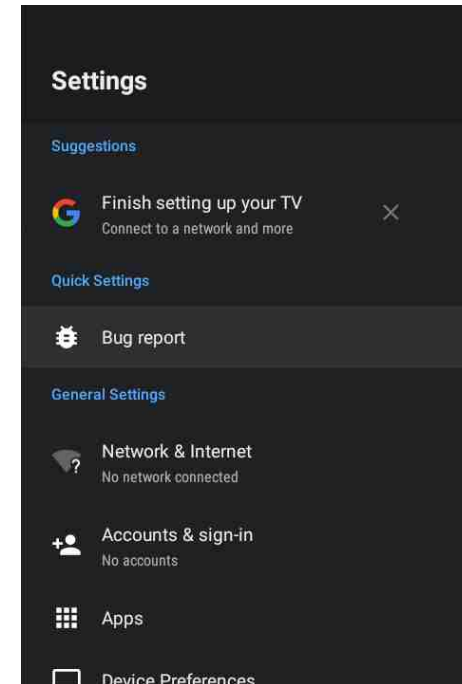

2. Press ▲/▼ button to select what you want set.
3. Press OK to enter setting.

Network

- 1 Press ▲/▼ button to select what you want set.
2. press OK button to adjust.
3. After finishing your adjustment, press OK button to save and return to the previous menu.

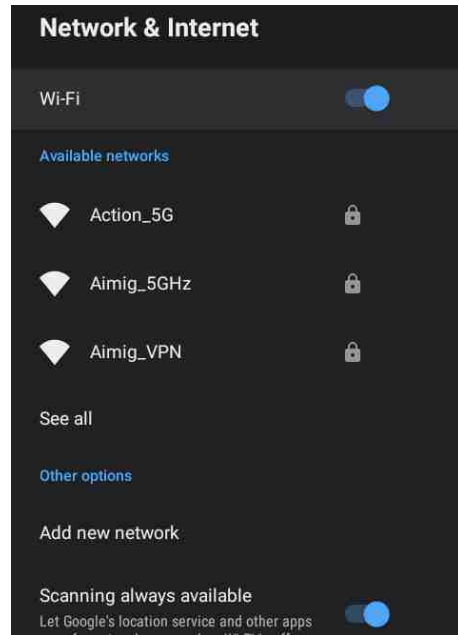

APPS

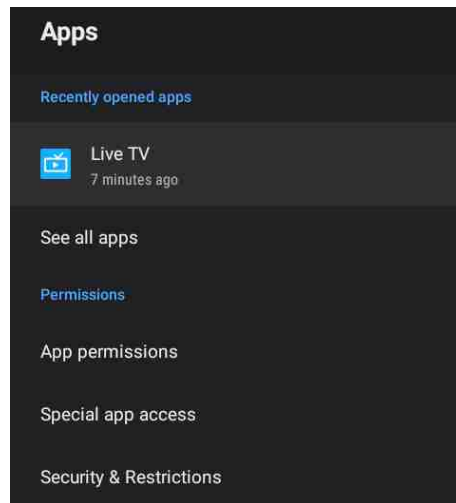

In this menu, you can set the APP permissions, and read the app lists.

1. Press ▲/▼ button to select what you want set.
2. Press OK button to adjust.
3. After finishing your adjustment, press BACK button to return to the previous menu.

DEVICE PREFERENCES ABOUT

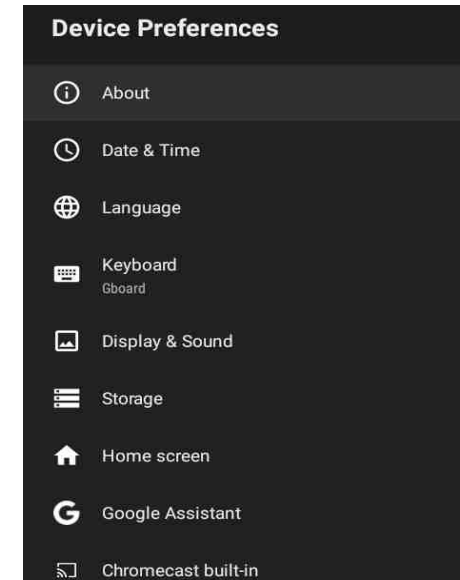

In this menu, you can read the information and settings of TV.

1. Press ▲/▼ button to select what you want set.
2. Press OK button to adjust.
3. After finishing your adjustment, press BACK button to return to the previous menu.

DATE & TIME

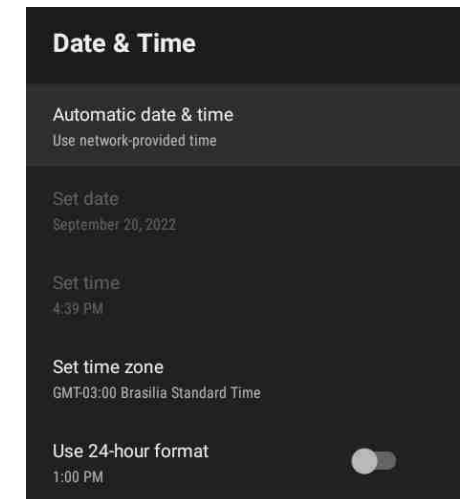

Automatic date & time- Press ▲/▼ button to select the option then press OK button to enter the sub-menu.(Optional: Use network-provided time, Off)

- Manually adjusting date & time settings will automaticall change the Automatic date & time to OFF.

Set date- Press ▲/▼ button to select the option then press OK button to enter the sub-menu.

Set time- Press ▲/▼ button to select the option then press OK button to enter the sub-menu.

Set time zone- Press ▲/▼ button to select the option then press OK button to enter the sub-menu.
Use 24-hour format- Press ▲/▼ button to select the option then press OK button to choose ON/OFF.

LANGUAGE

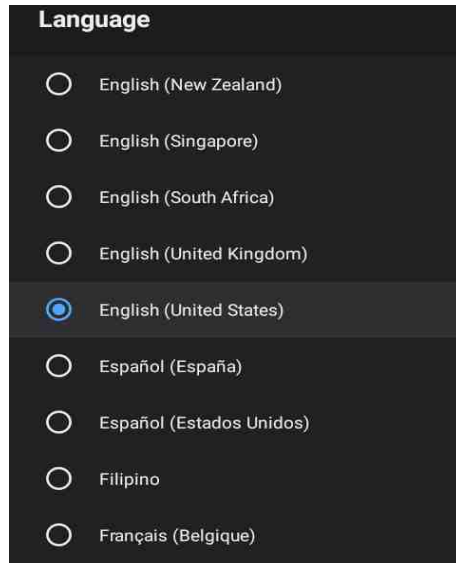

Language- Press ▲/▼ button to select the option then press button to enter the OK select language.

KEYBOARD

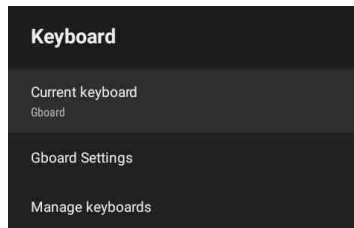

Current keyboard- Press ▲/▼ button to select the option then press OK button to enter the sub-menu.

Gboard Settings- Press ▲/▼ button to select the option then press OK button to enter the sub-menu.

Manage keyboards- Press ▲/▼ button to select the option then press OK button to enter the sub-menu.

STORAGE

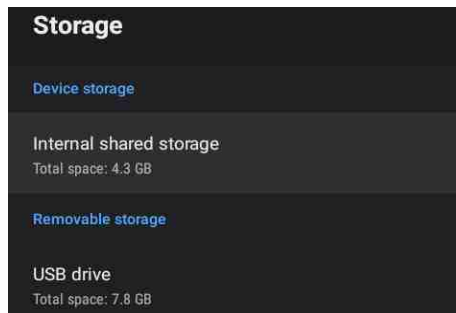

Internal shared storage- Press ▲/▼ button to select the option then press OK button to enter the sub-menu.

Removable Storage- Press ▲/▼ button to select the option then press OK button to enter the sub-menu.(Note: Show external devices if available)

HOME SCREEN

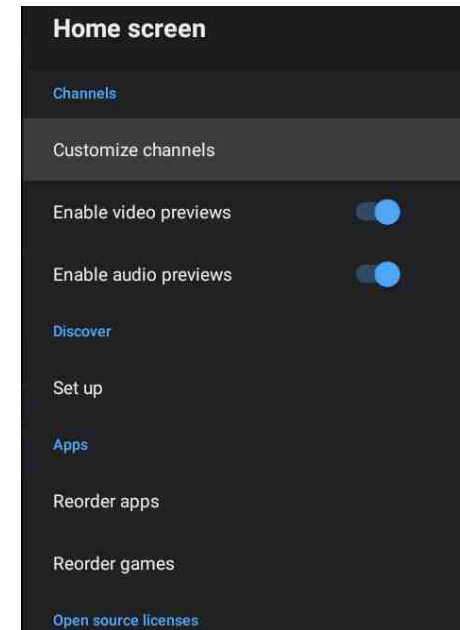

In this menu, you can set channels, apps, open source licenses.

1. Press ▲/▼ button to select what you want set.

2. Press OK button to adjust.

3. After finishing your adjustment, press BACK button return to the previous menu.

GOOGLE

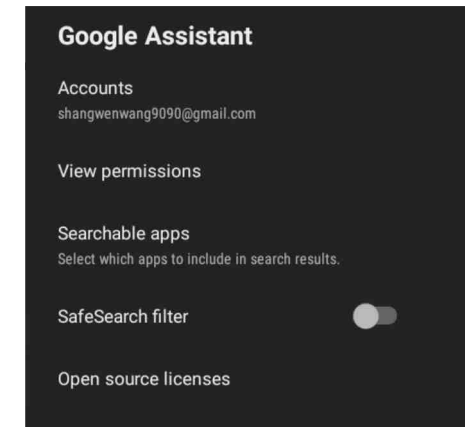

In this menu, you can set searchable apps, safe search filter, block offensive words, open source licenses.

1. Press ▲/▼ button to select what you want set.

2. Press OK button to adjust.

3. After finishing your adjustment, press BACK button return to the previous menu.

CHROMECAST BUILT-IN

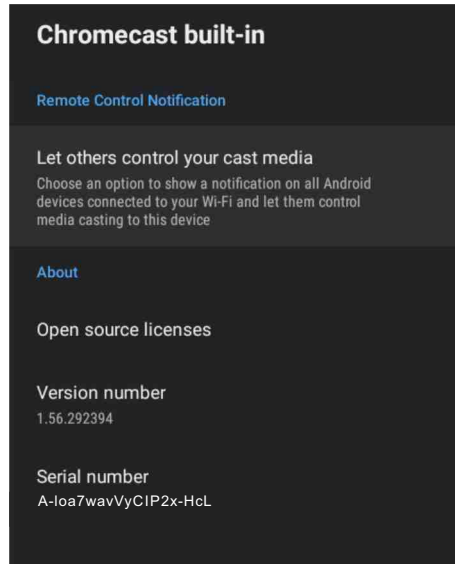

In this menu, you can read the information and settings of Chromecast.

1. Press ▲/▼ button to select what you want set.
2. Press OK button to adjust.
3. After finishing your adjustment, press BACK button return to the previous menu.

SCREEN SAVER

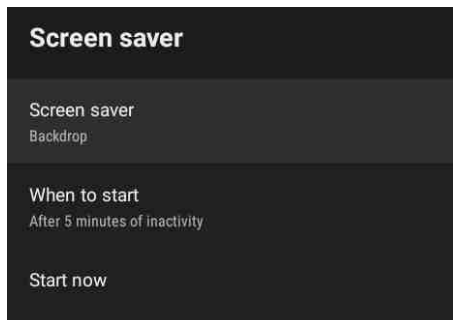

Screen saver- Press ▲/▼ button to select the option then press OK button to enter the sub-menu. (Optional: Turn screen off, Backdrop, Colors)

When to Start- Press ▲/▼ button to select the option then press OK button to enter the sub-menu. (Optional: 5 minutes, 15 minutes, 30 minutes, 1 hour, 2 hours.)

Start now- Press ▲/▼ button to select the option then press OK button to enter screen saver.

ENERGY SAVER

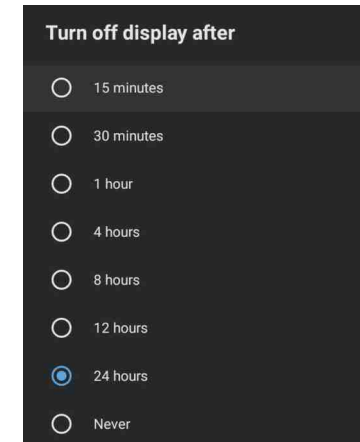

Turn off Display- Press ▲/▼ button to select the option then press OK button to enter the sub-menu. (Options: 15 minutes, 30 minutes,24 hours, Never.)

LOCATION

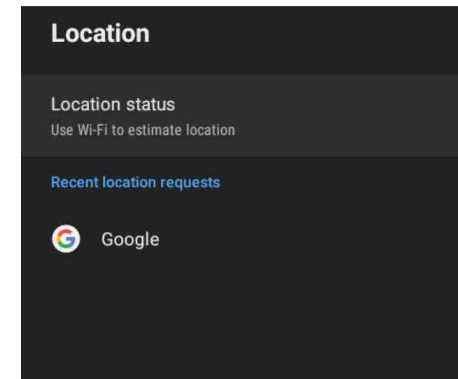

Location status- Press ▲/▼ button to select the option then press OK button to enter the sub-menu. (Optional: Use Wi-Fi to estimate location, Off)

USAGE & DIAGNOSTICS

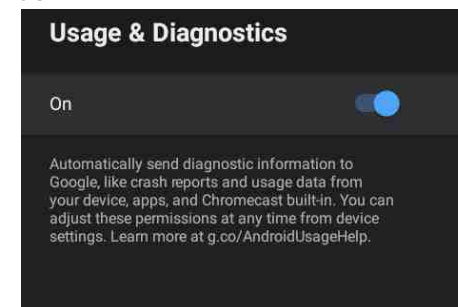

Usage & diagnostics- Press ▲/▼ button to select the option then press button OK to choose ON/OFF.

ACCESSIBILITY

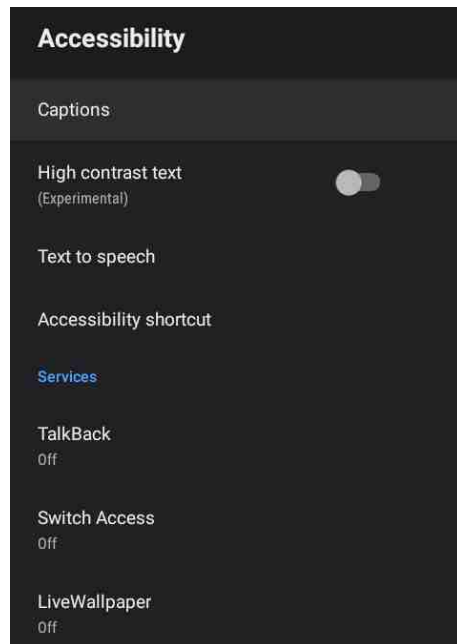

Captions- Press ▲/▼ button to select the option then press OK button to enter the sub-menu.
High contrast text- Press ▲/▼ button to select the option then press OK button to choose ON/OFF.
Text to speech- Press ▲/▼ button to select the option then press OK button to enter the sub-menu.
Accessibility shortcut- Press ▲/▼ button to select the option then press OK button to choose ON/OFF.
TalkBack- Press ▲/▼ button to select the option then press OK button to enter the sub-menu.
Switch Access- Press ▲/▼ button to select the option then press OK button to enter the sub-menu.

RESTART

Press OK button to enter the sub-menu.
Restart the TV.

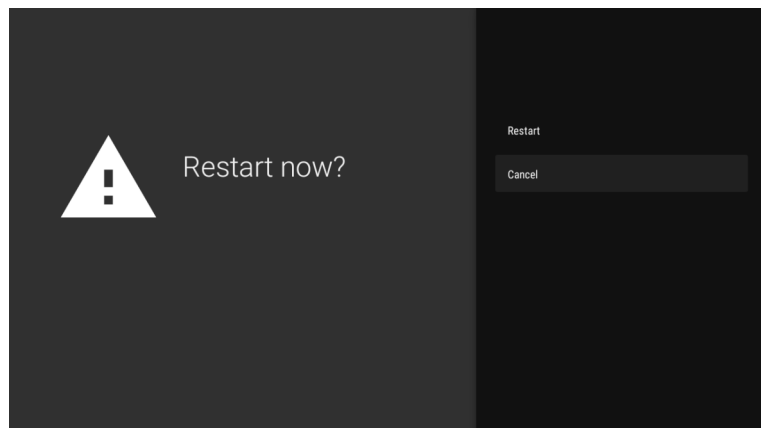

ADD AND USE OF MEDIA PLAYER

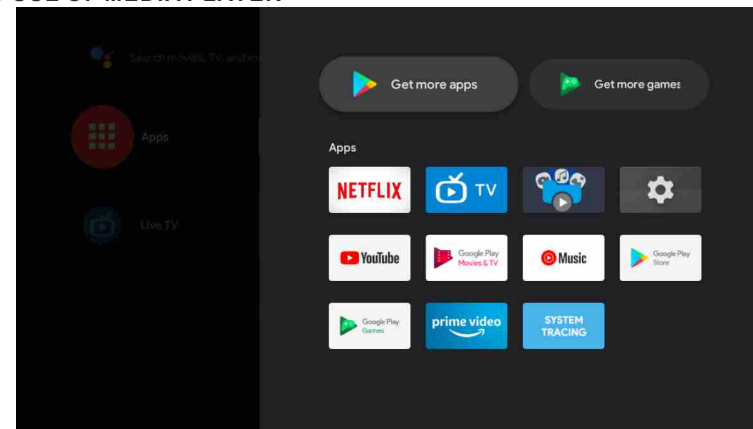

1. In the HOME interface, select the + icon in the APP column to add the application, and click OK. Press up and down to select the Media Player application, and click to add it OK to the HOME interface.

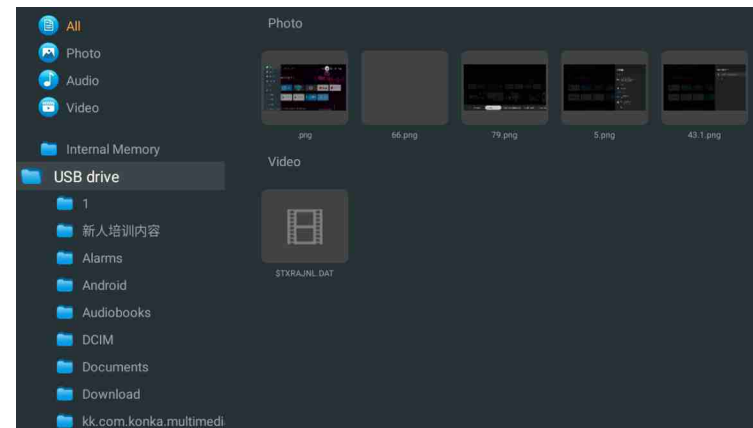

2. Focus on the corresponding USB driver and press OK to display video, photo, audio files. Press navigation button to select the file.

PICTURE

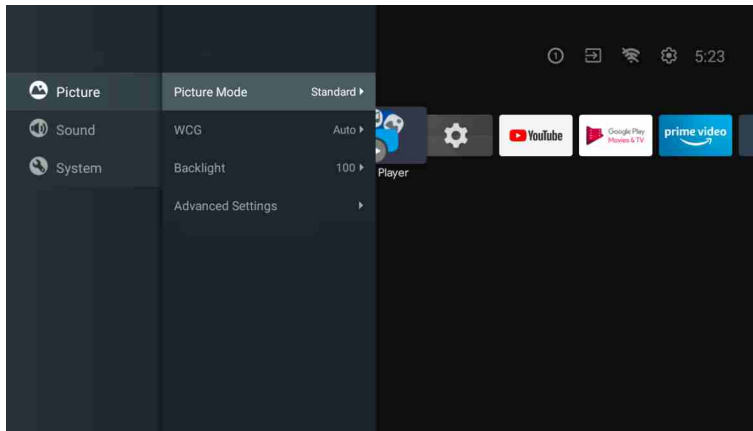

Picture Mode- Press ▲/▼ button to select the option button to enter the sub-menu. (Optional: Standard, Dynamic, Movie, Eye Comfort, Gentle, Vivid, Sport, Personal).

Brightness/Color Saturation/Hue/Contrast/Gamma/Black Level Sharpness- Press ▲/▼ button to select the option.

Press ◀ to decrease the parameter. Press ▶ to increase the parameter.

Gamma- Press ▲/▼ button to select the option.

Press ◀ to decrease the parameter.

Press ▶ to increase the parameter.

ECO

Press MENU key to the main menu, and select Picture.

Press button to ECO option and press OK to select the option.

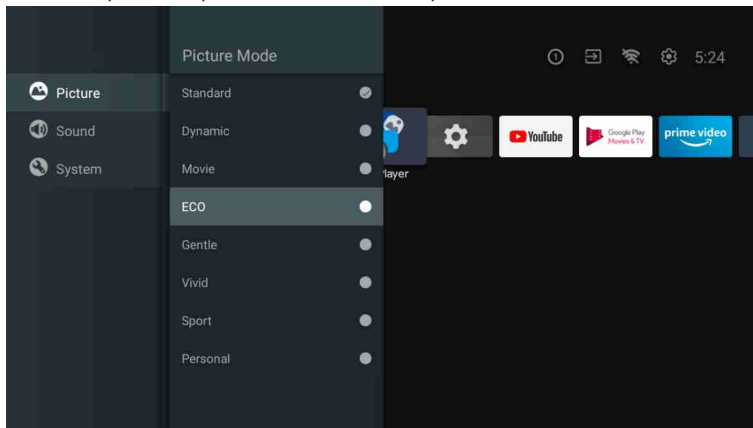

SOUND

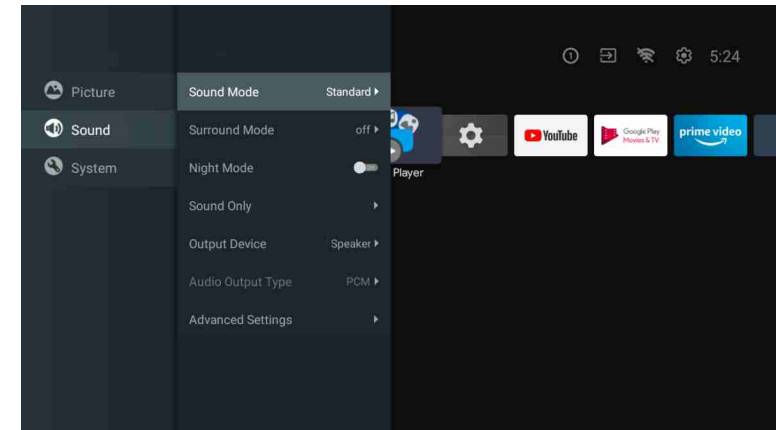

Press MENU key to the main menu, and select Sound.

Sound Mode- Press OK to enter the sub-menu, press button to select option and press OK to select the option.

Pure Sound- Press ▲/▼ button to select the option then press OK button to choose ON/OFF.

Surround- Press ▲/▼ button to select the option then press OK button to choose ON/OFF.

Sound Only- Press OK to enter the sub-menu, press OK button to select option.

Output Device- Press ▲/▼ to enter the sub-menu.

Audio Output Type- Press ▲/▼ to enter the sub-menu.

Advanced Settings- Press ▲/▼ to enter the sub-menu.



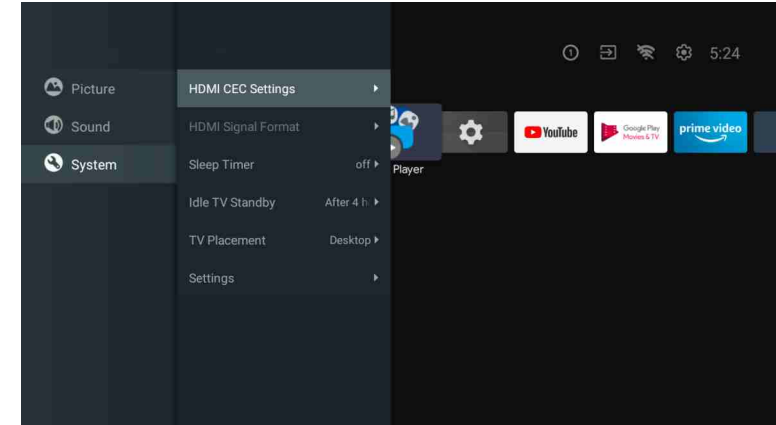

SYSTEM



Press MENU key to the main menu, and select System.

Press ▲/▼ button to select option and press OK to select the option.

Troubleshooting

Problem	Possible cause	Possible solution
No picture and sound.	<ul style="list-style-type: none"> The power adaptor is not plugged in or not working. The wrong input source is selected. The input source has failed to connect with the TV or is not turned on. 	<ul style="list-style-type: none"> Plug the power adaptor into a suitable outlet. Try both the 12/24V & 240V adaptors Select the correct input source. Make sure the input source is correctly connected and turned on.
No sound.	<ul style="list-style-type: none"> The volume control is set to minimum. The mute  button on the remote control has been pressed An incorrect sound system mode is set. 	<ul style="list-style-type: none"> Press the  button to increase the volume. Press  or the (or ) button to restore/increase the volume. Set a correct sound system mode from the main menu to match your TV source.
No picture, or monochrome picture only.	<ul style="list-style-type: none"> The colour system setting does not match the program. The sound system setting does not match the program. 	<ul style="list-style-type: none"> Select the appropriate colour system setting. Select the appropriate sound system setting. (If unsure, use Auto settings where available).
Sound or picture interference.	<ul style="list-style-type: none"> Some equipment that causes interference is close to the TV. More than one device is plugged into the same power outlet. An incorrect sound system mode is set. 	<ul style="list-style-type: none"> Keep interference-causing equipment away from the TV. Plug the power adaptor into another, separate power outlet. Set a correct sound system mode from the main menu to match your TV source.
PVR recording failed, or "DISK NOT READY" is displayed.	<ul style="list-style-type: none"> You may not have removed your USB device after the last recording, which is necessary to protect the device from damage. 	<ul style="list-style-type: none"> Remove the USB device after each recording if you experience recording problems. If "DISK NOT READY" is displayed, remove the device, reconnect and then proceed with your recording.

Problem	Possible cause	Possible solution
DTV Picture Pixelation	<ul style="list-style-type: none"> Poor Signal 	<ul style="list-style-type: none"> Adjust the position or orientation of the TV antenna. Check the antenna connection from the wall plate to the TV. Try re-tuning the channels as the channel frequencies may be different in some areas.