

ENCLAON

Gaming Monitor User Guide

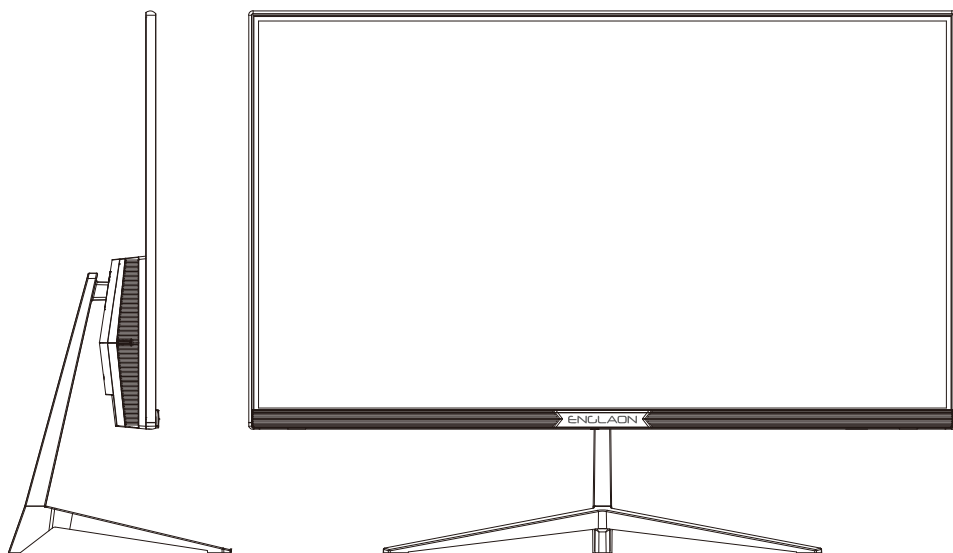

LED24G70

LED27G70

Read this instruction manual carefully
before use and retain it for future reference.



Catalog

I .Safety Precautions	-----	1
II .Connectivity	-----	2
III .Diagram of Control Keys	-----	3
IV .Installation Instruction	-----	4
V . OSD Adjustment Instructions	-----	5
VI .Specification parameter	-----	6
VII .Frequently Asked Questions (FAQ)	-----	7

I . Safety Precautions

- ◆ Do not leave the Monitor near water sources, such as bathrooms, washing machines, dishwashers, kitchens, swimming pools or in wet basements.
- ◆ Do not place the Monitor on an unstable car, chair, or table. If the Monitor falls down, it can injure the user and cause damage to the device.

You can place the Monitor in a car or on chair accordance to the recommendations of the manufacturer or Monitor supplier. If you fix Monitor to a wall or shelf, the fixed installation must be approved by the manufacturer and install it in strict accordance with the procedure.

- ◆ There are many long and narrow holes in the upper and lower parts of the rear shell for ventilation. To ensure that the Monitor continues to operate without overheating, these holes cannot be blocked or covered. Therefore, the Monitor must not be placed on a bed, sofa, rug, or similar surface, and it cannot be placed close to a radiator or heat source. It cannot be placed in bookcases or boxes, unless ventilation is ensured,
- ◆ The operating supply voltage range of Monitor is indicated on the rear shell label. If you cannot confirm the voltage supplied, consult your dealer or local power company.
- ◆ When the Monitor is not used for a long time, please turn off the power, which will prevent electric shocks and abnormal power supply voltage damage during lightning storms.
- ◆ Do not overload the socket, otherwise it may cause fire or electric shock.
- ◆ Do not hold the base to pull the whole machine upside down.
- ◆ Do not put foreign matters inside the machine, which can cause a short circuit and cause fire or electric
- ◆ Do not open the rear shell to protect it from high pressure or other hazards. If there is a fault, please contact the after-sales service personnel directly.
- ◆ Please plug the Monitor's plug into the nearest convenient electrical socket.
- ◆ The altitude and tropical environment for the adapter are determined by the adapters that are provided.
- ◆ The rear nameplate is marked with a  warning sign for this type of machine, which indicates the product is only suitable for safe use at an altitude of 2000m and below.
- ◆ The rear nameplate is marked with a  warning sign for this type of machine, which indicates that the product is only suitable for safe use in non-tropical climate conditions.

Class one energy efficiency label

Energy efficiency(cd/W)	>1.05
Energy consumption in closed state(W)	<0.5
Energy efficiency rating	Class 1
The number of energy efficiency national standard based on	GB 21520-2015

Class two energy efficiency label

Energy efficiency(cd/W)	>0.85
Energy consumption in closed state(W)	<1.0
Energy efficiency rating	Class 2
The number of energy efficiency national standard based on	GB 21520-2015

Warning 1: To prevent fire or explosion, do not expose the display to rain or wet environment. There is a dangerous high voltage in the Monitor.

Do not open the shell. If you need repair, you shall find a professional service person.

Warning 2: It is installed and connected to an output socket with protective earth termination by service personnel.

II. Connectivity

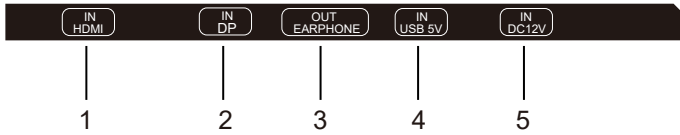
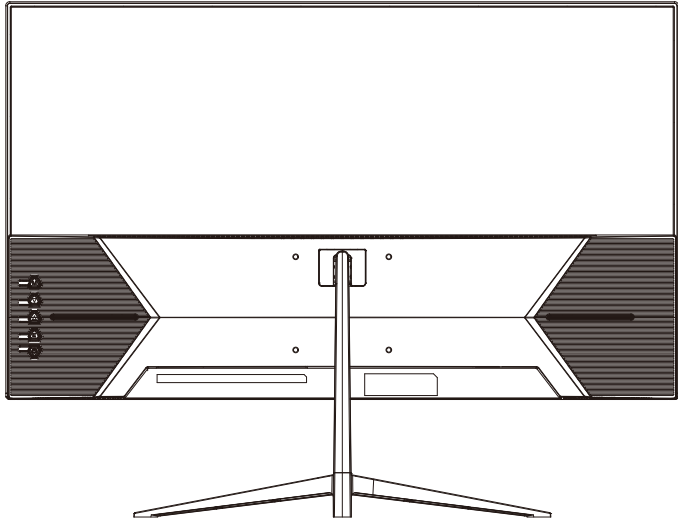

1. **HDMI**-HDMI IN
2. **DP**-DP IN
3. **EARPHONE**-EARPHONE OUT
4. **USB**-USB IN 5V
5. **DC**-DC IN 12V

III. Diagram of Control Keys

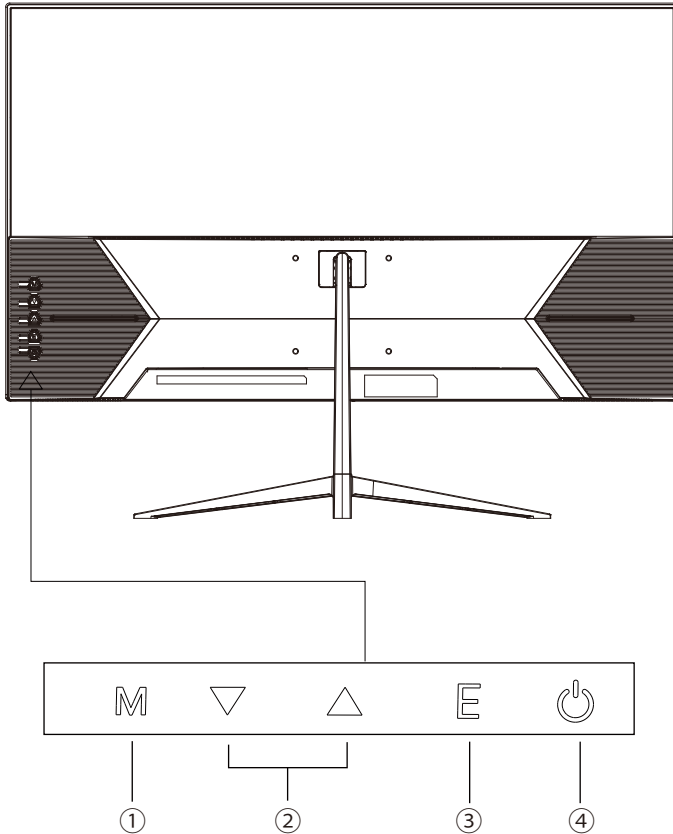

① Menu key

② Press the Up or Down key to adjust the Settings

③ Exit key/Auto adjust key

④ Press the power button to power on/off the monitor.

IV. Installation Instruction

1. Lay the monitor on a cloth with the LCD panel facing down to prevent the LCD panel from being damaged. Fix the stand body to the back of the monitor with the screws.

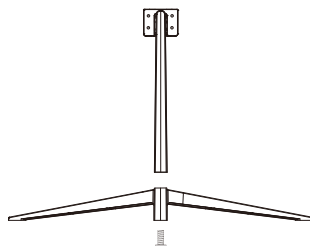
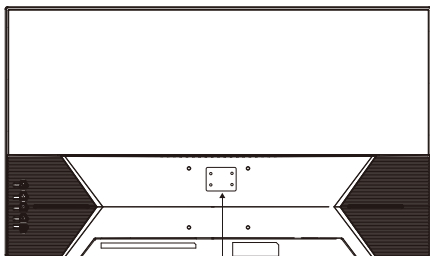



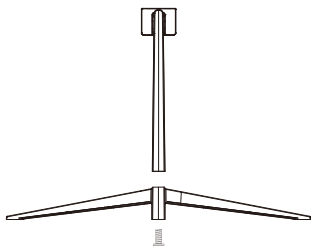

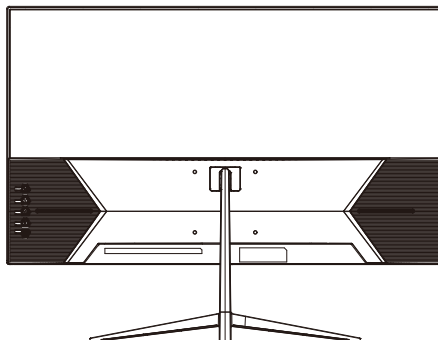
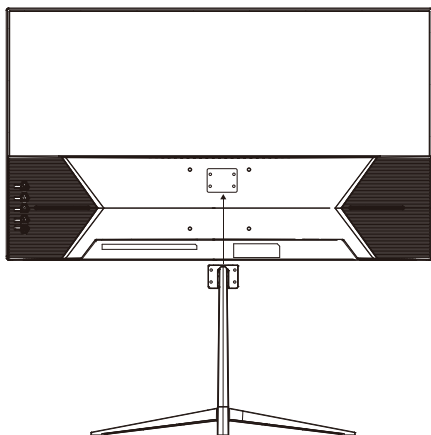

2. Fix the stand base to the stand body by tightening the screw.



3. Fasten the bracket to the monitor with screws.



V. OSD Adjustment Instructions

Main menu item	Main menu icon	Submenu items	Range Of Values	Instructions	
Picture		Brightness	0-100	Users can adjust the brightness display in the standard mode.	
		Contrast	0-100	Users can adjust the contrast display in the standard mode.	
		ECO Mode	Standard	Users choose the appropriate ECO mode according to personal preferences.	
			Game		
			Movie		
			Reading		
			FPS RTS		
		DCR	Off	Users can switch this menu item to adjust the DCR effect.	
On					
Low Blue Mode	0-100	Users can adjust this menu items to reduce eye damage.			
Overdrive	Off/On	Users can switch menu items to be on/off.			
Image Setup		Image Ratio	Wide 4:3	Users choose the appropriate image items according to personal preferences.	
		Super Sharpness	0-4	Users can adjust the sharpness in the standard mode.	
		Flickerfree	Off/On	Users can switch menu items to be on/off.	
Color Setup		Color Temp	Normal	Users choose the appropriate color temp. Items according to personal preferences.	
			Warm		
			Cool		
			User		
		Red	0-100		
Green	0-100				
Blue	0-100				
OSD Setup		Language	English	Users choose the appropriate language items according to personal preferences. (Nineteen Languages)	
			Japanese		
			Korean		
			Russian		
			Simplified Chinese		
H. Position	0-100	Users can adjust the OSD position, timer, transparency.			
V. Position	0-100				
Timeout	10-60				
Transparence	0-100				
Reset		Reset	/	Press this menu to restore default values.	
Extra		Input Select	DP	Users can select the personal preferences source.	
			HDMI		
		OSD Mute	Off/On	Users can switch menu items to be on/off.	
		Volume	0-100	Users can adjust the Volume in the standard mode.	
			HDR		Auto
					Off On
Free Sync	Off/On	Users can switch menu items to be on/off.			

VI. Specification parameter

	Size	24 inch	27 inch
	Model Name	LED24G70	LED27G70
	Brightness(Typical)	220cd/m2 (Typ)	250cd/m2 (Typ)
	NTSC	72% NSTC	100% sRGB
	Contrast(Typical)	3000:1 (Typ)	3000:1 (Typ)
	Resolution (H x V)	1920 (H) × 1080 (V)	1920 (H) × 1080 (V)
	Aspect Ratio	16:9	16:9
	Response Time(Typical)	1ms (OD)	1ms (OD)
	View Angles LR,UD(CR>10)	H 178°/ V 178°(Min)	H 178°/ V 178°(Min)
	Panel Surface	Anti-Glare	Anti-Glare
	Display Colors	8bit+FRC colors	8bit+FRC colors
PC Input Range	Vertical Freq.	165Hz	165Hz
	Max. display frequency (Resolution H*V/Fv)	1920*1080/165Hz	1920*1080/165Hz
Interface	Input 1	HDMI x 1	HDMI x 1
	Input 2	DP x 1	DP x 1
	Input 3	USB x 1	USB x 1
Output Terminal	Earphone	Earphone x 1	Earphone x 1
	Speaker(Typic)	2W*2(8Ω)	2W*2(8Ω)
Projection screen	Wireless projection	NA	NA
	Wired projection	NA	NA
Power	Consumption(Typical)	Standby≤0.5W	Standby≤0.5W
	PD POWER	36W	42W
	Power Mode Indicator Light	RED/BLUE (LED)	RED/BLUE (LED)
Operating Condition	Temperature	0°C ~ 40°C	0°C ~ 40°C
	Humidity	20% ~ 85%, non-condensing	20% ~ 85%, non-condensing
Physical	Dimension (W*D*H)	542*170*415	616*201*449
	Dimension (without base) (W*D*H)	542*46*321	616*51*364
	Packing Dimension (W*D*H)	591*106*382	680*115*420
	Net Weight	3.00	3.46
	Gross Weight	3.94	4.54
	Tilt	-5°~15°	-5°~15°
	VESA Mounting	YES(75mm)	YES(100mm)
	Swivel	NO	NO
	Pivot	NO	NO
Accessory	Kensington Lock	YES	YES
	Adapter	12V 3A	12V 3.5A
	HDMI Cable	x 1 (1.0M)	x 1 (1.0M)
	User Manual	YES	YES
Color		Black	Black
Carton Box		Standard	Standard

VII. Frequently Asked Questions (FAQ)

Problems that arise	Possible solutions
Power indicator light is off	<ul style="list-style-type: none">* Check whether to turn on the power* Check whether or not to connect the power line
Unable to achieve plug and play	<ul style="list-style-type: none">* Check whether the PC is matched with plug and play* Check whether the Monitor card is matched with plug and play* Check whether the signal cable 15-pin D-shaped connector is bent
Image is dim	<ul style="list-style-type: none">* Adjust brightness and contrast ratio
Image jumps or appears rippled	<ul style="list-style-type: none">* There may be electrical devices that cause electrical interference around
The power indicator light is on (flashing),	<ul style="list-style-type: none">* Check whether the computer power is turned on
But the Monitor has no image display	<ul style="list-style-type: none">* Check whether the computer video card is inserted* Check whether the Monitor's signal cable is properly connected to the computer* Check the Monitor's signal cable plug and make sure the pins are not bent* Check whether the computer is operating by pressing the Caps Lock key on the PC keyboard
Lack of color (red, green, blue)	<ul style="list-style-type: none">* Check the Monitor's signal cable plug and make sure the pins are not bent
The screen is not in the middle or the size is not suitable	<ul style="list-style-type: none">* Adjust the clock (CLOCK) or press the hotkey (AUTO)
The image has a color difference (white does not look white)	<ul style="list-style-type: none">* Adjust RGB color or reselect color temperature
Weak brightness and contrast ratio	<ul style="list-style-type: none">* When the Monitor is used for a period of time, if the brightness is reduced to affect normal use, please send the Monitor to an authorized service facility for repair
Image horizontal or vertical interference	<ul style="list-style-type: none">* Turn off the Windows operating system and adjust CLOCK or execute the AUTO key.

Read this instruction manual carefully
before use and retain it for future reference.