

CONTENT

Important Safety Instructions	1
Box Contents	2
Installation Guide	3
Charging Your Vehicle	5
Operation of Control	5
EV Charger App	8
Status and troubleshooting	9
Product Specifications	10
Limited Warranty Information	11
Warranty Card	12

- ⚠ Warning: Read this entire document and follow all warnings and instructions before installing and using the EV Charger. Install and use this product only within the specified operating parameters as instructed in the manual. Failure to comply can lead to property damage, injury, or death, and will void the Limited Warranty.
- ⚠ Warning: Do not use the EV Charger if any component appears to be broken, cracked, frayed, or show any indication of damage or defect. Please contact the Fulsolen Customer Service Department immediately, refer to page 9 for contact information.
- ⚠ Warning: The EV Charger is not user-serviceable, do not attempt to open, disassemble, repair, service, or modify the product. Please contact the Fulsolen Customer Service Department if assistance is needed, refer to page 9 for contact information.
- ⚠ Warning: Always plug the EV Charger directly into the outlet with the supplied power adapter. Do not use extension cords, multi-outlet adapter, multi-plug, conversion plug or power strip to plug in the product.
- ⚠ Warning: Do not use private power generators as a power source for the EV Charger to charge vehicles.
- ⚠ Warning: Never disconnect the EV Charger's power adapter from the power outlet while the vehicle is still charging. Always stop the charging process, disconnect the charging handle from the vehicle, then disconnect the power adapter from the outlet.
- ⚠ Warning: Always inspect the outlet before plugging the EV Charger in and ensure all prongs of the power adapter are fully inserted into the outlet. The power adapter may overheat and cause damage or injury if it is not inserted properly. Do not plug the product into an outlet that appears damaged, loose, or worn.
- ⚠ Warning: Always connect the EV Charger into a power outlet that is properly grounded.
- ⚠ Warning: Do not expose the EV Charger to any flammable, explosive, or combustible materials/vapors.
- ⚠ Warning: Do not install or use the EV Charger near flammable, explosive, or combustible materials/vapors, or if exposed to severe rain, snow, thunderstorm, or any other inclement weather.
- ⚠ Warning: If possible, avoid installing the EV Charger in direct sunlight.
- ⚠ Warning: Handle all components of the EV Charger with care. Do not drop, drag, batter, twist, tangle, step on or exert strong force/impact on the EV Charger.
- ⚠ Warning: Do not allow moisture, water, or debris to enter the openings of the EV Charger, especially the outlet, connector or charging handle port.
- ⚠ Warning: Do not plug the EV Charger into an outlet if it is submerged in water or covered in snow. If the product is already plugged in, turn off the breaker before unplugging the power adapter.
- ⚠ Warning: Do not touch the connectors of the EV Charger power adapter or control box with your fingers or other objects, including wire, tools, or needles. Do not fold any component of the product by force or damage it with sharp objects. Do not insert foreign objects into the product.
- ⚠ Warning: Install and mount the EV Charger in a position so it does not hang from the power outlet. The power outlet and adapter are not designed to support the weight of the EV Charger.
- ⚠ Warning: Hang the EV Charger's charging cable on the supplied hook in a location that prevents obstruction of pedestrians, pets, vehicles, or other objects. Position it in such a way to prevent damaging or stressing the components. Do not subject the charging cable to excessive forces or impact, such as closing a garage door or driving over it.
- ⚠ Warning: Operation of the EV Charger may affect the functionality of medical or implantable electronic devices, such as implantable cardiac pacemakers or implantable cardioverter defibrillators. Prior to using the product, consult with the electronic device manufacturer regarding potential effects that charging may have on such electronic devices.
- ⚠ Warning: Take care in cleaning the EV Charger. It is recommended to unplug the EV Charger LE from the outlet first prior to cleaning. Use a soft cloth slightly dampened with water or mild detergent to clean the surface of the EV Charger.
- ⚠ Warning: The EV Charger has a built-in automatic CCID reset function.
- ⚠ Warning: Do not use the EV Charger if the ambient temperature is outside of its operating temperature range of -22°F to 122°F (-30 C to 50 C).
- ⚠ Warning: Store the EV Charger at a clean dry location with ambient temperature between -40°F and 185°F (-40 C and 85 C).
- ⚠ Warning: The product features triple-layer overheating protection with temperature control unit in the control box and adapter.
- ⚠ Warning: Please do not unplug the adapter if it is wet. Dry it off before unplugging.
- ⚠ Warning: The EV Charger is compatible with the SAE J1772 specifications and can be used to charge battery electric and plug-in hybrid vehicles with SAE J1772 charging ports.
- ⚠ Warning: Do not allow children to install or use the EV Charger. Children should be supervised when they are in the vicinity of the product during its operation.

BOX CONTENTS



Check the box to make sure you have all the components listed below (Picture 1).
If any parts are missing, please contact the Fulsolen Customer Service Department:
support.global@fulsolen.com.

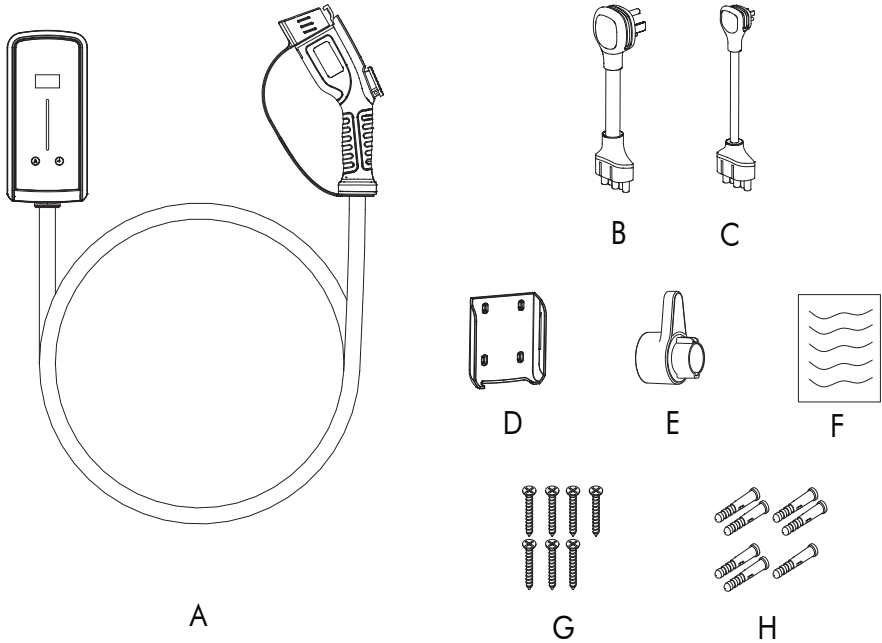

Picture 1.

Inside the boxes you'll find:

- A. Charger station/control box
- B. N14-50P adapter
- C. N5-15P adapter
- D. Wall-mount bracket
- E. Charging handle holster and cable holder
- F. User manual
- G. M4*30 countersunk head tapping screws (for "D" and "E")
- H. M6*30 plastic expansion wall plugs screw anchor (for "D" and "E")

INSTALLATION GUIDE

For the recommended installation height of the Fulsolen EV Charger please refer to Picture 2.

Locate the outlet you wish to wall-mount your EV Charger on. The wall-mount bracket should be installed based on the measurements (in millimeters) shown below (Picture 3).

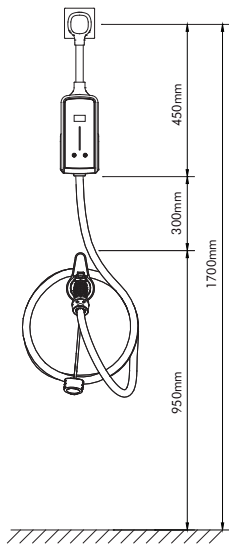

Picture 2.

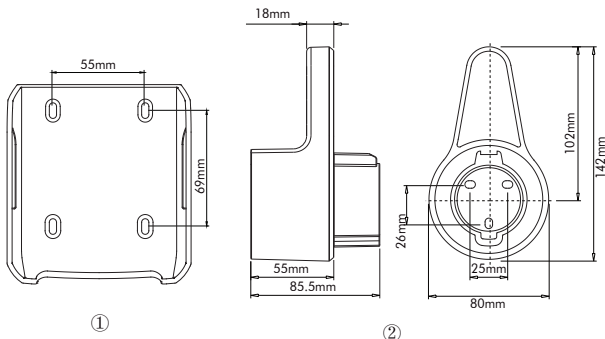

Picture 3.

- ①. Wall-mount bracket (**item D**) screw position
- ②. Charging handle holster and cable holder (**item E**) screw position

STEP 1

Based on the measurements in Picture 3, drill two pilot holes for the wall-mount bracket and two pilot holes for the cable hook.

Place the M6*30 plastic expansion wall plugs screw anchors (**item I**) over each hole and firmly tap it in until it's flush with the wall. If you do not require wall anchors, please skip this step and proceed directly to Step 2.

STEP 2

Line up the wall-mount bracket (**item E**) and screw in the two M4*30 countersunk head tapping screws (**item H**).

Line up the charging handle holster and cable holder (**item F**) and screw in the remaining two M4*30 countersunk head tapping screws (**item H**). (See Figure 4)

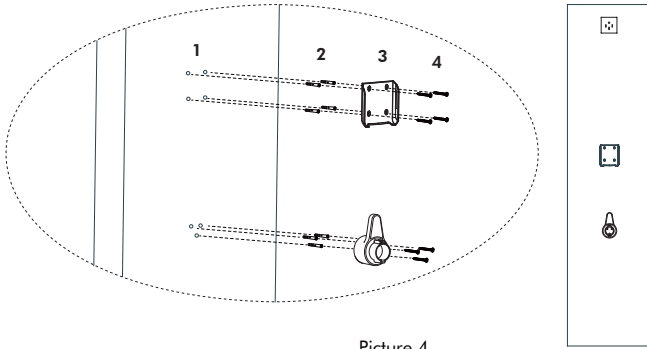

Picture 4.

STEP 3

Depending on the outlet type (N5-15P or N14-50P), plug the corresponding adapter (item B/C) to the charging station/control box (item A) first.

STEP 4

Install the charging station/control box (item A) on the wall-mount bracket (item D), and wrap the cable to your desired length on the charging handle holster and cable holder (item E).

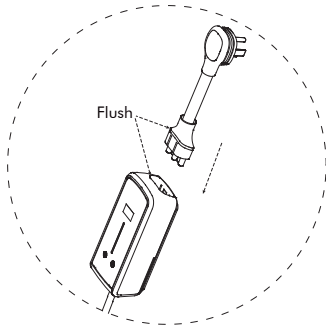

Picture 5.

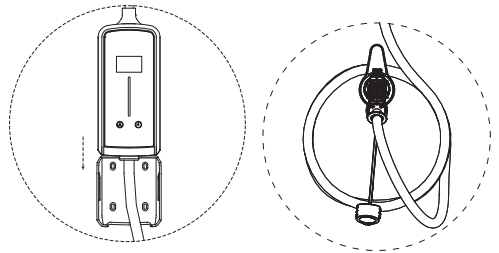

Picture 6.

STEP 5

Plug the adapter into the wall outlet and wait for the charging station/control box (item B) to power on.

Note: Always inspect the Power Adapter for damage prior to each use.

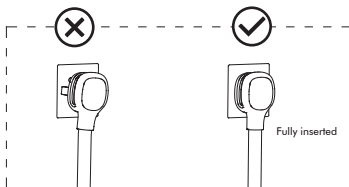

Picture 7.



CHARGING YOUR VEHICLE

STEP 1

Plug the adapter into the wall outlet and wait for the EV Charger (**item A**) to power on.

STEP 2

Adjusting the appropriate current and delayed charging time. Refer to Page 6 for more informations.

STEP 3

Insert charging handle into the vehicle.

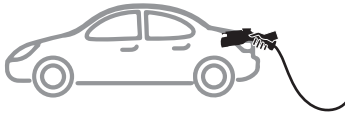

STEP 4

When vehicle is finished charging, unplug and put the charging handle into the wall-mounted holster. Then disconnect the power from the socket.



Warning

We DO NOT recommend using a third-party adapter. Fulsolen's 2-year product warranty does not cover any damage caused by improper use or external electric faults.

If you have been notified of the above warning notification but still proceed with a third-party adapter, make sure that the charging handle is pulled out before you conduct Step 1. Before moving to Step 3, please also make sure to set the charging amperage lower than the maximum rated power of the third-party adapter. Refer to Page 6 for more information.

OPERATION AND CONTROL

1. Control panel

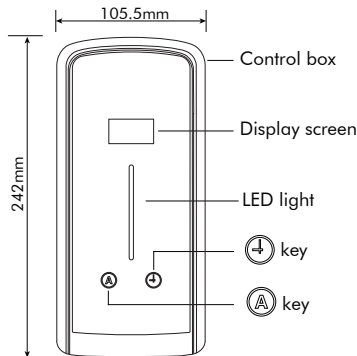

LED light status description

LED light status	Description
Green light breathing	Ready
Green light constant	The charging handle is not plugged in during the scheduled session.
Green light flowing	The charging handle is plugged in during the scheduled session.
Blue light flowing	Charging
Blue light constant	Charging is completed
Red light constant	Alarm state



Note: The display will show this warning message if the EV Charger is plugged in to a power outlet that is not properly grounded. After waiting for 3 seconds, the EV Charger will enter into "Standby" mode.



Ungrounded !
3 s

Warning of ungrounded power outlet

2. Standby interface. Once the EV Charger is powered on, the OLED display will alternate between "Standby Interface 1" and "Standby Interface 2".

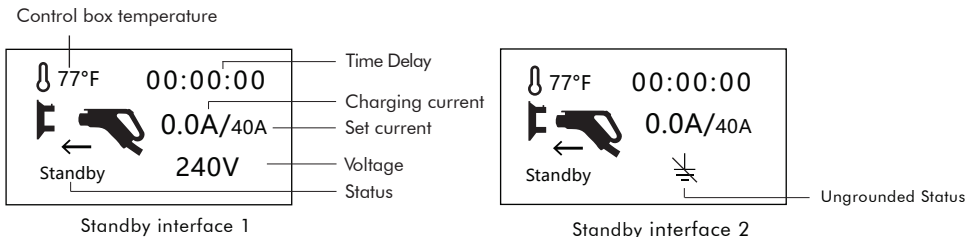

3. Charging current setting. Once the EV Charger enters into the "Standby Interface", you can press the **(A)** button to select a charging current between 8A/12A/16A/24A/32A/40A. Once the charging current is selected, press and hold the **(A)** button for 3 seconds to confirm the option. If you have selected 40A, the EV charger will start to charge your car at 40 Amps once the EV charger is powered on.

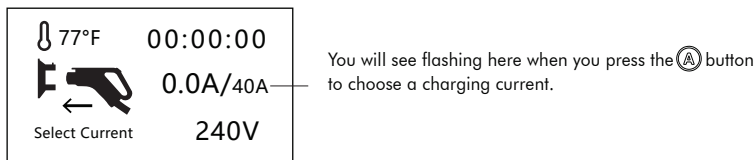

4. Charging delay setting. Press the **(⌚)** button to schedule the charging start time (each time you press the button, the charging time will be postponed by one hour). Once you have selected the start time that you want, press and hold the **(⌚)** button for 3 seconds to confirm the setting.

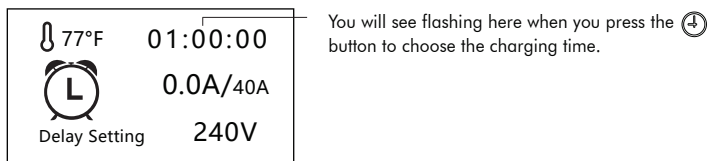

5. Charging. Once the setup is complete, plug the charging handle into the charging port to start charging. When the charging starts, you will see the interfaces below alternate on the OLED display.

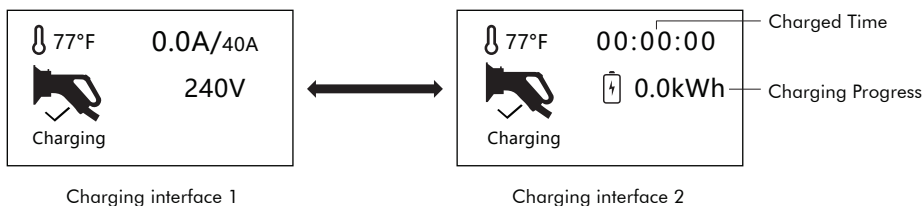

6. Charging Complete. Once charging is complete, the EV Charger will enter "Charging Over" mode. You will see the following interfaces alternate on the OLED display.

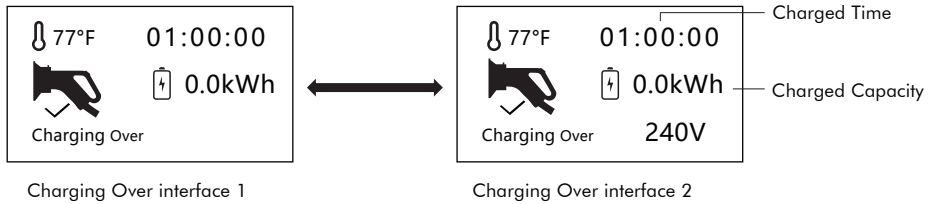

7. Force-stop charging. If you want to stop charging during the charging session, you can press and hold the **(A)** button for 3 seconds to enter into the Stop Charging Interface. Press and hold the button again for 3 seconds to confirm. When the charging stops, the OLED display will show "Charging Over".

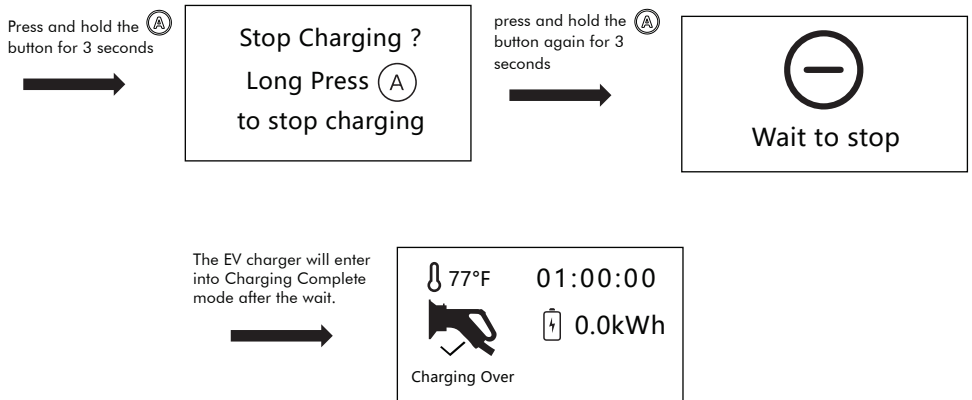

Caution: Please DO NOT unplug the charging handle during the charging session. Please follow the Stop Charging process by pressing and holding the **(A)** button. Make sure the EV Charger is in "charging Over" mode before unplugging the charging handle. Electric shock hazards may occur if you fail to follow the steps above.

8. Starting a New Charging Task After Device Enters "Charging Over" Interface Following 7. If you have force-stopped a charging task and want to start a new charging task, you can press the **(A)** button to adjust the charging current. Then press and hold the **(↓)** button again for 3 seconds to confirm. Then press the **(↓)** button, set the clock to 00:00:00 and press and hold the **(A)** button to start a new charging session.

9. Abnormal warning interface

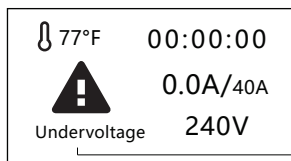

Alarm status
and alarm type



The OLED display
cannot connect to
the control box

DOWNLOAD THE EV CHARGER APP

Scan the QR code on the below to download the App. You can also search for "Fulsolen" on the Google Play Store or Apple Store to download the App for free.



For more App introduction, please visit: <https://xes-evcharger.cn/fulsolenapp/>.



STATUS AND TROUBLESHOOTING

Status	LED light status	Action
Starting	Green light breathing	No action required.
Standby	Green light breathing	No action required.
Select Current	Green light flashing	No action required.
Delay Setting	Green light flashing	No action required.
Connect	Green light constant	No action required.
Charging	Blue light flowing	No action required.
Charging Over	Blue light constant	No action required.
CP Signal Error	Red light constant	Please contact Customer Support.
Overvoltage	Red light constant	Unplug the adapter from the outlet, and then plug it back in. If the problem persists, please contact Customer Support.
Undervoltage	Red light constant	Unplug the adapter from the outlet, and then plug it back in. If the problem persists, please contact Customer Support.
Overcurrent	Red light constant	Unplug the charging handle from the vehicle, and then plug it back in. If the problem persists, please contact Customer Support.
Power Leakage	Red light constant	Unplug the charging handle from the vehicle, and then plug it back in. If the problem persists, please contact Customer Support.
Adapter Overheating	Red light constant	Please check if the adapter is properly plugged in the power outlet. Replace it with a new power outlet if it is worn out. If the problem persists, please contact Customer Support.
Control Box Overheating	Red light constant	Wait for the device to cool down and it will automatically resume charging. If the problem persists, please contact Customer Support.
Relay Failure	Red light constant	Unplug the adapter from the outlet, and then plug it back in. If the problem persists, please contact Customer Support.
Relay Self-check Failure	Red light constant	Unplug the adapter from the outlet, and then plug it back in. If the problem persists, please contact Customer Support.
Power Leakage and Self-Check Failure	Red light constant	Unplug the adapter from the outlet, and then plug it back in. If the problem persists, please contact Customer Support.

Need further assistance?

Please contact the Fulsolen Customer Service Department: support.global@fulsolen.com.

PRODUCT SPECIFICATIONS

Model	EFAC40FA11		EFAC32FA11		EFAC40FA12	EFAC32FA12
Adapter	N5-15P	N14-50P	N5-15P	N14-50P	N14-50P	N14-50P
Input Voltage	120Vac	240Vac	120Vac	240Vac	240Vac	240Vac
Output Current	12A	40A	12A	32A	40A	32A
Max. Output Power	1.4kW	9.6kW	1.4kW	7.6kW	9.6kW	7.6kW
Output Voltage	100-250 volt AC single-phase					
Input Frequency	50Hz or 60Hz					
Control Box Material	PC+PBT. Flame retardance UL94: 5VA					
Charging Port Type	SAE J1772					
Handle Material	PC+PBT. Copper, silver-plated					
Cable Material	Copper + TPE					
Total Length	22ft (6.6 meters) with charging handle installed					
Impact Resistance	Able to withstand 3.3ft (1 meter) free fall drop and 4,409 lbs (2,000kg) vehicle crush test without critical damage.					
LED Indicator	Red/green/blue					
LCD display	1.3 inch OLED blue screen					
Operating Temperature	-22°F ~ 122°F (-30°C ~ 50°C)					
Working Humidity	5%~95% without condensation					
Working Altitude	< 1.24 miles (2,000 meters)					
Control Box Enclosure Type	NEMA 4 (IP66)					
Operating Environment	Indoor/outdoor					
Cooling Method	Natural cooling					
Multiple Protection	Over-voltage protection, Under-voltage protection, Overheating protection, Over-current protection, Leakage protection, Grounding protection, Lightning protection, Fire and flame protection, Waterproof, Dust proof, Antistatic protection					
Safety Standard	UL 2594, UL2231-1, UL2231-2, CSA C22.2 No.280, CSA C22.2 No.281.1, CSA C22.2 No.281.2					
Others Certification	FCC, FCC ID, Energy Star					
Control Box Dimensions	9.53 x 4.15 x 2.66 inch (242 x 105.5 x 67.5mm)					
Carrying Case Dimensions	15.35 x 13.78 x 5.12inch (390 x 350 x 130mm)	15.35 x 13.39 x 4.33inch (360 x 340 x 110mm)	17.13 x 13.78 x 5.12inch (435 x 350 x 130mm)	17.13 x 13.78 x 5.12inch (435 x 350 x 130mm)		
Package Dimensions	17.72 x 16.14 x 7.28inch (450 x 410 x 185mm)	16.73 x 15.94 x 6.69inch (425 x 405 x 170mm)	19.29 x 15.75 x 7.87inch (490 x 400 x 200mm)	19.29 x 15.75 x 7.87inch (490 x 400 x 200mm)		
Net Weight	13lbs (5.9kg)	9.7lbs (4.4kg)	12.3lbs (5.6kg)	9lbs (4.1kg)		
Gross Weight	17.2lbs (7.8kg)	16.5lbs (7.5kg)	17.2lbs (7.8kg)	13.9lbs (6.3kg)		
External Packing	Carton					
Charging Handle / Connector Life Cycle	10,000 insertion/removal events (no load)					
Dynamic Load Balancing	Optional					
Communication	Bluetooth/RS485 (Optional)					
Application	Android/IOS					
Warranty	2-year limited warranty					

LIMITED WARRANTY INFORMATION

Limited Warranty for the EV Charger

- a. Fulsolen offers a limited warranty for a period of 2 years to the original purchaser at retail of the Fulsolen EV Charger. This limited warranty is not transferrable and is only available in the U.S.A. and Canada. Fulsolen (corporate name) warrants this product will conform to our published specifications in effect as of the date of shipment and be free from material defects in material and workmanship.
- b. We warrant that we shall perform all services using personnel of required skill, experience and qualifications and in a professional and workmanlike manner in accordance with generally recognized industry standards for similar services.
- c. Except for the warranty provided in section (a), we make no warranty or condition whatsoever with respect to the Fulsolen EV Charger, including, any warranty or condition of merchantability, fitness for a particular purpose or title; whether express or implied by law, course of dealing, course of performance, usage of trade or otherwise.
- d. This limited warranty does not cover any defects or damage caused by normal wear, misuse, improper installation, external electric faults, improper service or maintenance, abuse, negligence or accident, including but not limited to:
 - Failure to follow the instructions and warnings outlined in the user manual supplied with the EV Charger.
 - Cosmetic damage such as scratches, chips, dents and cracks.
 - Abuse, vandalism, damage or other defects caused by accidents, misuse or negligence.
 - Disassembly or modification or repair of the EV Charger by an unauthorized party.
 - Damage, alteration, removal, or anything that renders the EV Charger's serial numbers to be illegible.
 - Damage to the EV Charger caused by hardware or software not supplied by Fulsolen.
 - Damage from extreme power surge, electromagnetic field or any acts of nature.
 - Any other causes beyond the control of Fulsolen.
- e. This limited warranty is void if the product is used after you give us such notice of defect; misused; subject to careless handling; is modified in any way; or has suffered physical damage or is repaired by anyone other than the factory or its authorized representative; or the defect arises because you failed to follow our oral or written instructions as to the storage, installation, commissioning, use or maintenance of the products.
- f. If the product is found to be defective in material or workmanship during the warranty period, Fulsolen will either repair or replace the product at its option, provided that any products are returned to Fulsolen at the Purchaser's expense and in accordance with the Warranty Claims Procedure Policy below. At the discretion of Fulsolen, the repair parts and/or replacement products may either be new or reconditioned. The repair or replacement EV Charger will be warranted for the remainder of the original warranty period.
- g. Fulsolen makes no warranty other than this limited warranty and expressly excludes any implied warranty including any warranty for incidental or consequential damages, including any liability under any theory of law whether contract, tort or otherwise, even if Fulsolen has been informed of the possibility of such damages. All claims related to the EV Charger will not exceed the price you paid for the product. Your statutory rights are not affected.
- h. THIS IS YOUR SOLE AND EXCLUSIVE LIMITED WARRANTY. THE REMEDIES SET FORTH IN THIS WARRANTY AND IN THE WARRANTY CLAIMS PROCEDURE POLICY SHALL BE YOUR SOLE AND EXCLUSIVE REMEDY AND OUR ENTIRE LIABILITY FOR ANY BREACH OF THIS LIMITED WARRANTY. NO ONE IS AUTHORIZED TO ALTER, MODIFY, AMEND, OR EXTEND THIS WARRANTY OR MAKE ANY OTHER WARRANTY ON BEHALF OF FULSOLEN. NO WARRANTIES APPLY AFTER THE WARRANTY PERIOD HAS EXPIRED. YOUR STATUTORY RIGHTS ARE NOT AFFECTED.

WARRANTY CLAIMS PROCEDURE POLICY - How to Submit a Warranty Claim

1. If you believe you have a defective EV Charger during the warranty term, contact Fulsolen Customer Service support.global@fulsolen.com and provide the following written information:
 - A detailed description of the defect or problem you are experiencing with the EV Charger.
 - The model number and serial number of the EV Charger.
 - Proof of original purchase.
 - Your contact information and return shipping address.
 - If warranty repair is deemed necessary, please complete and detach the Warranty Card on page 12 with all required information.
2. A Fulsolen representative will troubleshoot the EV Charger and determine if there is a defect with the product and whether it is covered under this warranty.
3. If the defect with your EV Charger is determined by Fulsolen to be covered by this warranty within the warranty term, please complete and detach the Warranty Card on page 12 and include the card when returning your EV Charger.
4. You are responsible to package the EV Charger and all its original components either in its original box or packaging that provide the EV Charger an equivalent level of protection as its original packaging and forward the unit together with proof of purchase and Warranty Card to the location which will be provided by Fulsolen Customer Service. You will assume risk of any loss or damage to the EV Charger during shipment to Fulsolen.
5. If Fulsolen determines the defective EV Charger is covered under this warranty, Fulsolen will repair or replace the product and ship it back to you with a shipping carrier of our choice, at no charge to you.
6. If any EV Charger is determined by Fulsolen to be ineligible for warranty service or falls outside the scope of this warranty, Fulsolen will offer to repair or replace the product at your expense upon your approval, at Fulsolen's prevailing parts and labour rates. Return shipping will also be arranged at your expense upon your approval.

FULSOLÉN

Email: support.global@fulsolen.com

<http://www.fulsolen.com>