

EJ PRIMA



Victoria Arduino

INSPIRED BY YOUR PASSION.





VERSATILE & ECLECTIC

PRIMA is

the one group espresso coffee machine ready to bring wherever and whenever the VICTORIA ARDUINO coffee experience.

We called it this way because we believe it is the first step towards a new frontier and will overcome many boundaries.

It is a new way to prepare and enjoy espresso coffee.

It is dedicated to baristas planning their coffee business, to roasters that would like to search and offer a serene coffee experience for their clients, to professionals that desire a high-quality espresso even at home, and to all the international community of **coffee lovers**.

It is a versatile and eclectic coffee machine that opens to a new way of living and perceiving the coffee experience.

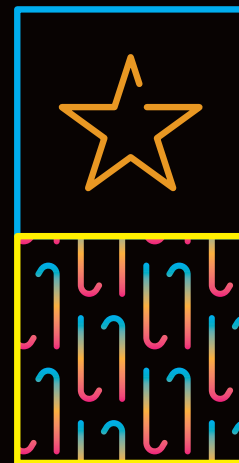

EJ PRIMA



WATCH THE VIDEO





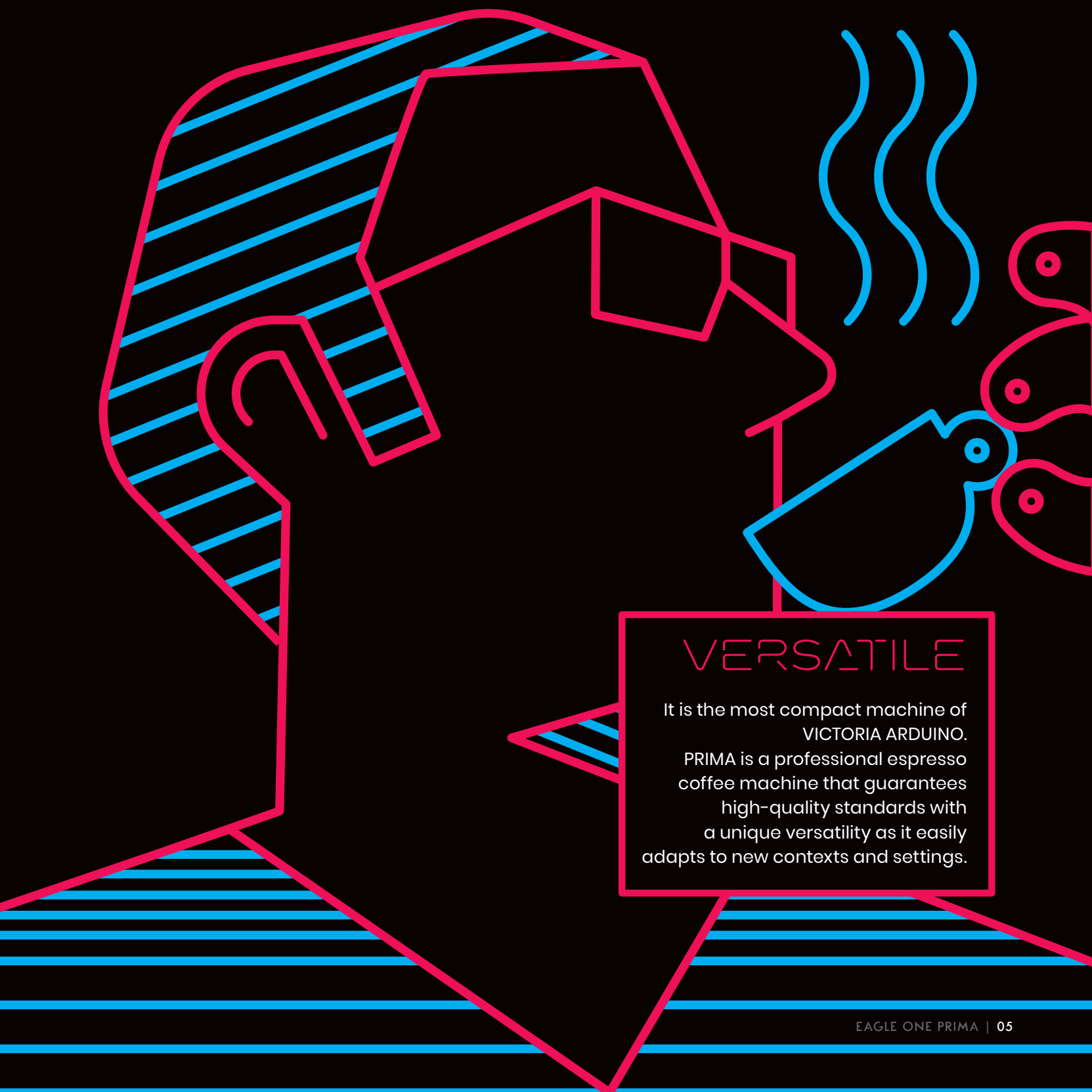

VERSATILE

It is the most compact machine of VICTORIA ARDUINO. PRIMA is a professional espresso coffee machine that guarantees high-quality standards with a unique versatility as it easily adapts to new contexts and settings.



EJ PRIMA

FOR AN UNLIMITED
COFFEE
EXPERIENCE

Before Prima, never has a VICTORIA ARDUINO been so flexible and adaptable! It fits just right into small workspaces. It is ideal for start-ups and renowned businesses, professional and home use, exclusive boutiques that often change looks, pop, and classy atmospheres, even where coffee is not the center activity. For any style and every occasion, there is always a PRIMA that suits you!





A stylized graphic of an eye, rendered in teal and pink lines. The eye is looking towards the right. The iris is a teal circle with a pink outline. The eyelids are defined by thick teal lines, with the upper eyelid having a series of parallel teal lines. The background is black, and there are various pink and teal lines and shapes scattered around the eye, including a pink dashed line, a pink solid line, and a teal circle.

ECLECTIC

Today, design is the research of details and distinctiveness.

PRIMA can transform while remaining the same and matches flawlessly with the concept of ECLECTICISM. It can change based on the environment and spaces it sits in, but it can also change seasonally by modifying its looks and adding fresh new colors and textures that interpret the current trends.



DESIGN & PERSONALITY

With many images for a unique idea of accessible glamour like a tailored dress or fashion accessory, PRIMA is available in many colors and exclusive editions.

Standard colors



MATT WHITE



SHINY



MATT BLACK

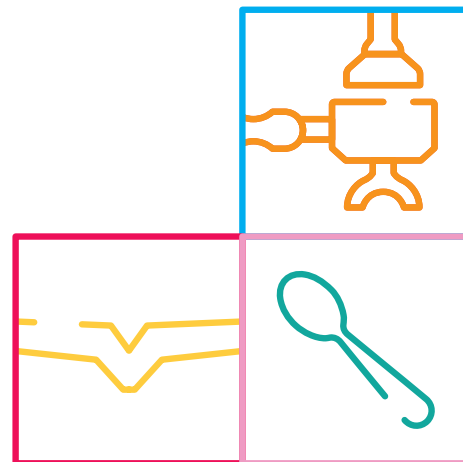
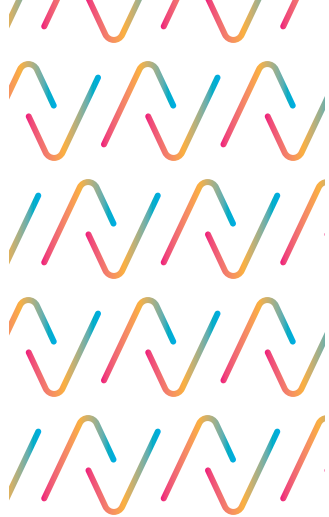

Special colors



RED*



BLUE*



GREEN*

* RAL SPECIAL COLOR REQUEST

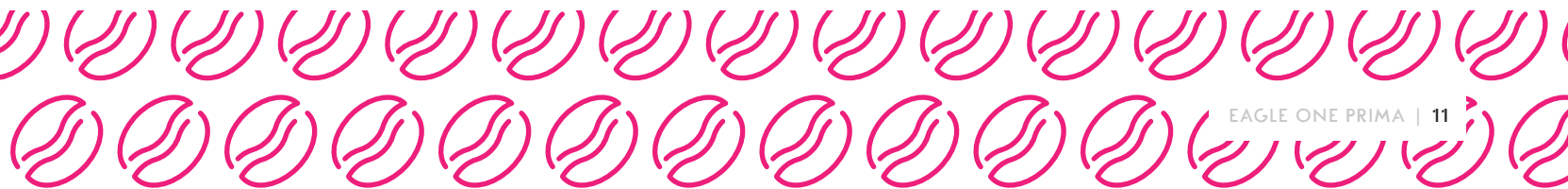

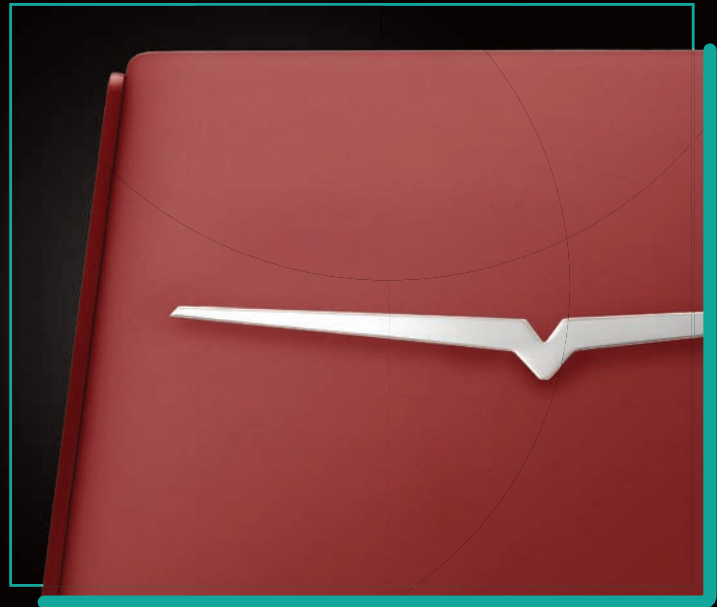

DESIGN AND SIMPLICITY

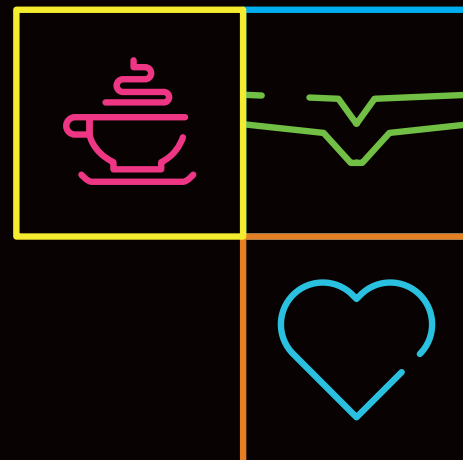

Minimal, made in Italy and refined: PRIMA stands out not only for its pure and simple design but also because it effortlessly adapts to any environment or setting.

The perfect mix of design and technology substantially impacted the structure of the machine and the internal components. The result was an extremely compact object, ergonomic, slim, and elegant.

It is an object that shines under the spotlight.





COMPACT AND SUSTAINABLE

The size and the choice of using resistant and high thermal efficient material like stainless steel allow PRIMA to adapt to any use and limit water and heat dispersion.

The design, the applied technologies, and the components insulation contribute to reducing environmental impact, making PRIMA an authentic, sustainable machine.



Energy optimization

The engine with **NEO technology (New Engine Optimization)** guarantees high performance, reducing energy consumption and heating times. Unlike other professional machines of the same category, PRIMA takes **less than 8 minutes** to prepare and reach a full working regime.

Low environmental impact

The constructive approach strongly reduced the machine's volumes, thus reducing environmental impact while keeping performance high.



New materials

The boilers are made in stainless steel and protected by an innovative material that guarantees high thermal insulation and avoids heat dispersions.

Steam electronic control

Energy efficiency is guaranteed by the electronic controller **Steam-by-Wire** that allows significant control of the steam dispensing along with an elevated power/speed ratio.



E1 PRIMA

ADVANCED TECHNOLOGY,
HIGH EFFICIENCY

The secret to
an unlimited sustainability



NEW ENGINE OPTIMIZATION

Only the energy needed, instantly and when requested

The **NEO engine (New Engine Optimization)** represents a new approach to heating water for coffee extraction using less energy.

Thanks to this technology, PRIMA can heat the water quickly and guarantee high performance, while increasing which are thermally insulated energy efficiency. Even if the boilers are smaller in volume, they are thermally

insulated and protected by an innovative material that avoids energy dispersions.

The procedure is efficient, yet simple and intuitive: only the temperature must be programmed on the **VICTORIA ARDUINO app**.

The machine's electronic system does the rest, keeping the temperature stable during the entire dispensing phase.



NEW ENGINE OPTIMIZATION

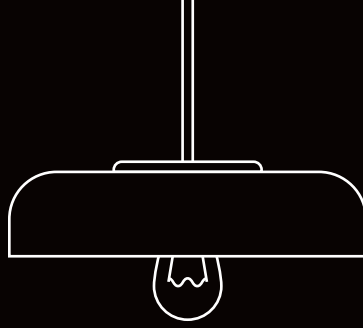

LESS IS MORE

Steam module:

- Power: 1600 W
- Material: stainless steel
- Range: 0.8 - 3 bar (suggested value: 2.1 bar)
- Electronic steam control
- Volumetric pump: 50lt/h

Brewing module

- Range: 80-105°C

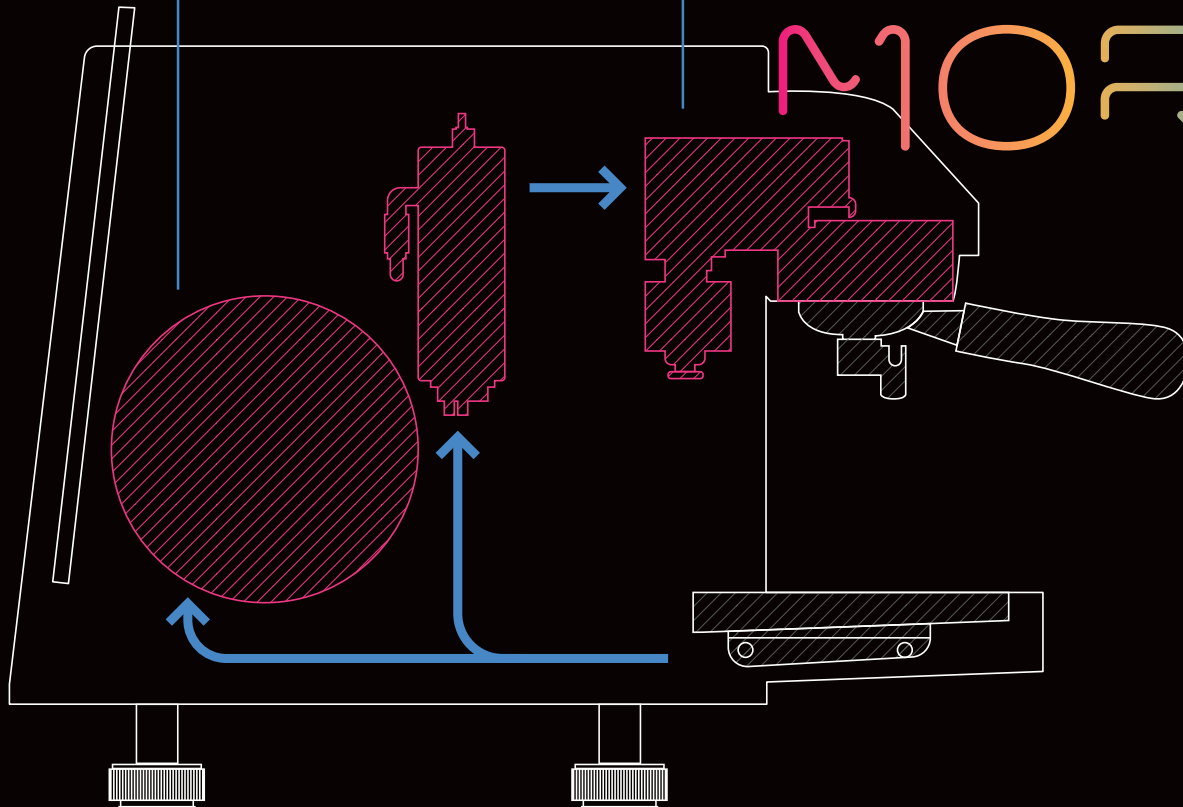

Fewer emissions, less environmental impact

During the project phase, the environmental impact was given significant attention. The choices made in terms of new materials, specific technologies, and design reduced the emissions drastically compared to machines of the same category and design, drastically reduced the emissions compared.



NEO (New Engine Optimization) is a new concept engine that uses **instant heating** technology that requires less volume, therefore smaller boilers, and only the needed water is heated.





EFFICIENT STEAM IN LESS TIME

Unlike other machines of its category that have manual steam levers, PRIMA equips an electronic lever.

The system **Steam-by-Wire** allows a significant steam dispensing control with a pressure up to 2.5 bar (the standard measure is 2.1) and an elevated power/speed ratio. The machine guarantees an increased high-quality

dry and saturated steam production to compose an excellent milk cream as quickly as possible. For example, a 2 bar pressure heats 250gr of milk (the equivalent of two cappuccinos) in less than 18 seconds.

This high productivity is a perfect match with reliable temperature stability, even if the time intervals are relatively close.



100% DIGITAL MACHINE





Settings, uses,
programs:
everything in one app

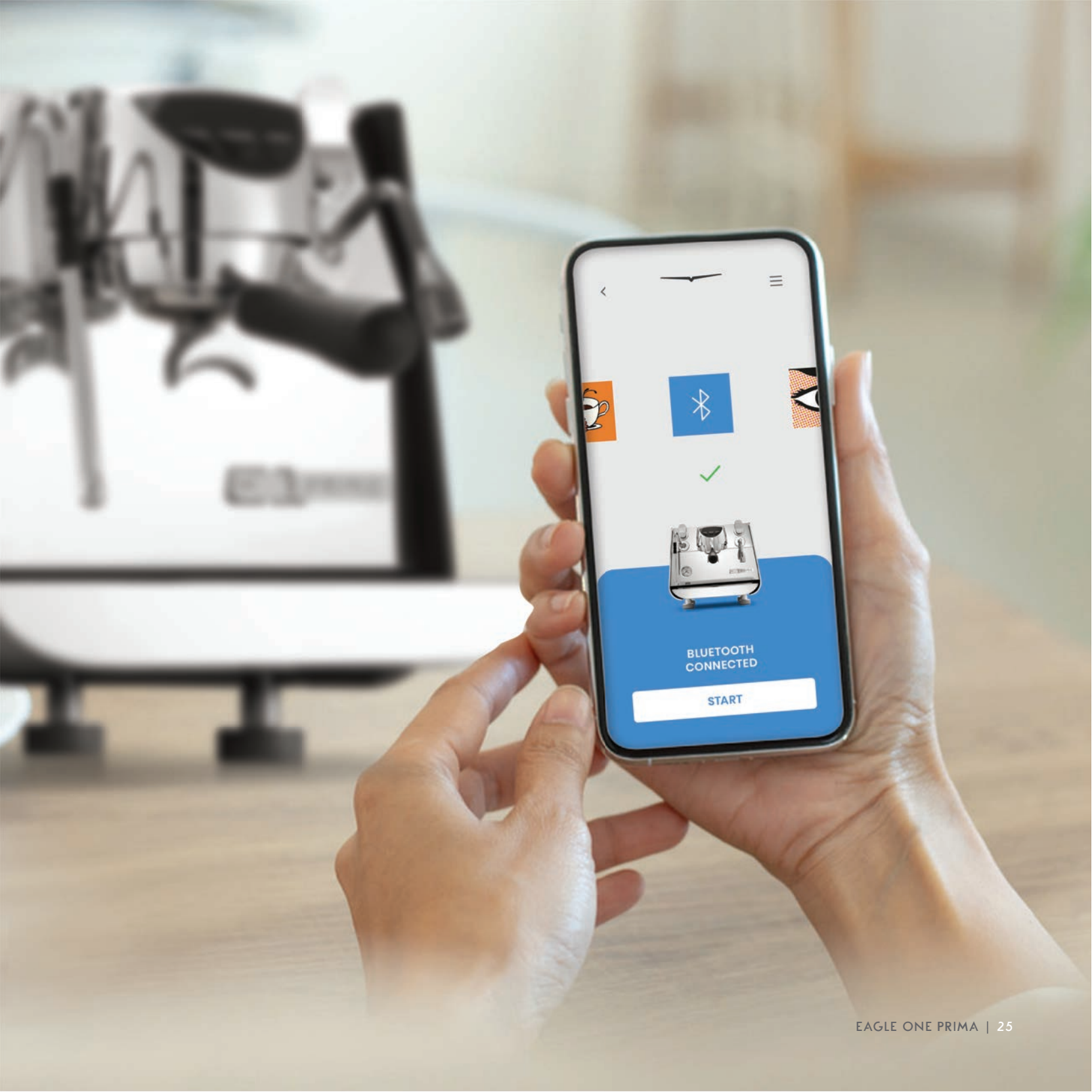

Everything becomes even simpler, just like using an app and being fully connected. Who buys a PRIMA will immediately have an app that optimizes performance and use. It's possible to set the temperature and see the extraction time along with the steam and hot water from the app.

PRIMA is an espresso coffee machine that takes advantage of the digital revolution and is in constant contact with the user.

The app can create recipes, share them with other users, or set recipes recommended by their roaster or barista. The app can also become a recipe sharing instrument by going on the section 'Cloud recipe' of the Victoria Arduino app.



<  





BLUETOOTH
CONNECTED

START



DETAILS AND OPTIONS THAT MAKE THE DIFFERENCE

AVAILABLE WITH TANK OR DIRECT CONNECTION

Two versions to offer and excellent coffee experience whenever and wherever.

COOL TOUCH STEAM WAND -

Standard version

The **Cool Touch** steam wand avoids any risk of burns and simplifies the cleaning procedure.

THE STEAM WANDS EXCLUSIVE DESIGN

The unique design offers infinite possibilities: the wand allows using different size pitchers and has a dedicated space to **purge**. It simplifies the cleaning procedure and avoids any burn injuries.

EASY CREAM - Optional

The solution allows the user to replicate the same milk cream in a fast and straightforward way.

GROUP COVER

The keypad simplification with three keys and led lights that flash if an alarm is detected, for example, machine overheating or an empty tank, allows the barista to control the extraction in an even more efficient manner.

GHOST DISPLAY

The display is perfectly integrated into the machine's group cover. Once the dispensing has finished, it disappears and blends into the machine's group cover design.



E1 PRIMA COLOURS

MATT WHITE

SHINY

MATT BLACK



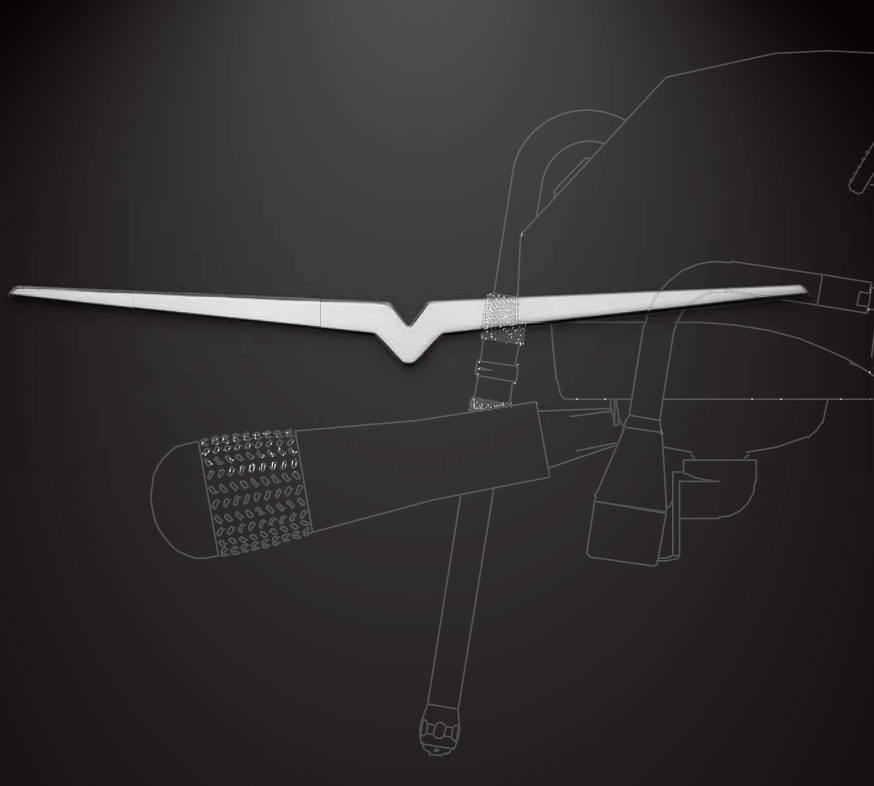

combinations

COLOURS	FRONT SIDE ALUMINIUM	ALUMINIUM SIDE PANELS	ALUMINIUM SUPERIOR BACK SIDE	EAGLE	ALUMINIUM INFERIOR BACK SIDE	STAINLESS STEEL INFERIOR BACK SIDE
SHINY	chrome	shiny	shiny	shiny	shiny	stainless steel
MATT BLACK	chrome	matt black	matt black	shiny	matt black	matt black
MATT WHITE	chrome	matt white	matt white	shiny	matt white	stainless steel

E1 PRIMA DETAILS AND MEASUREMENTS

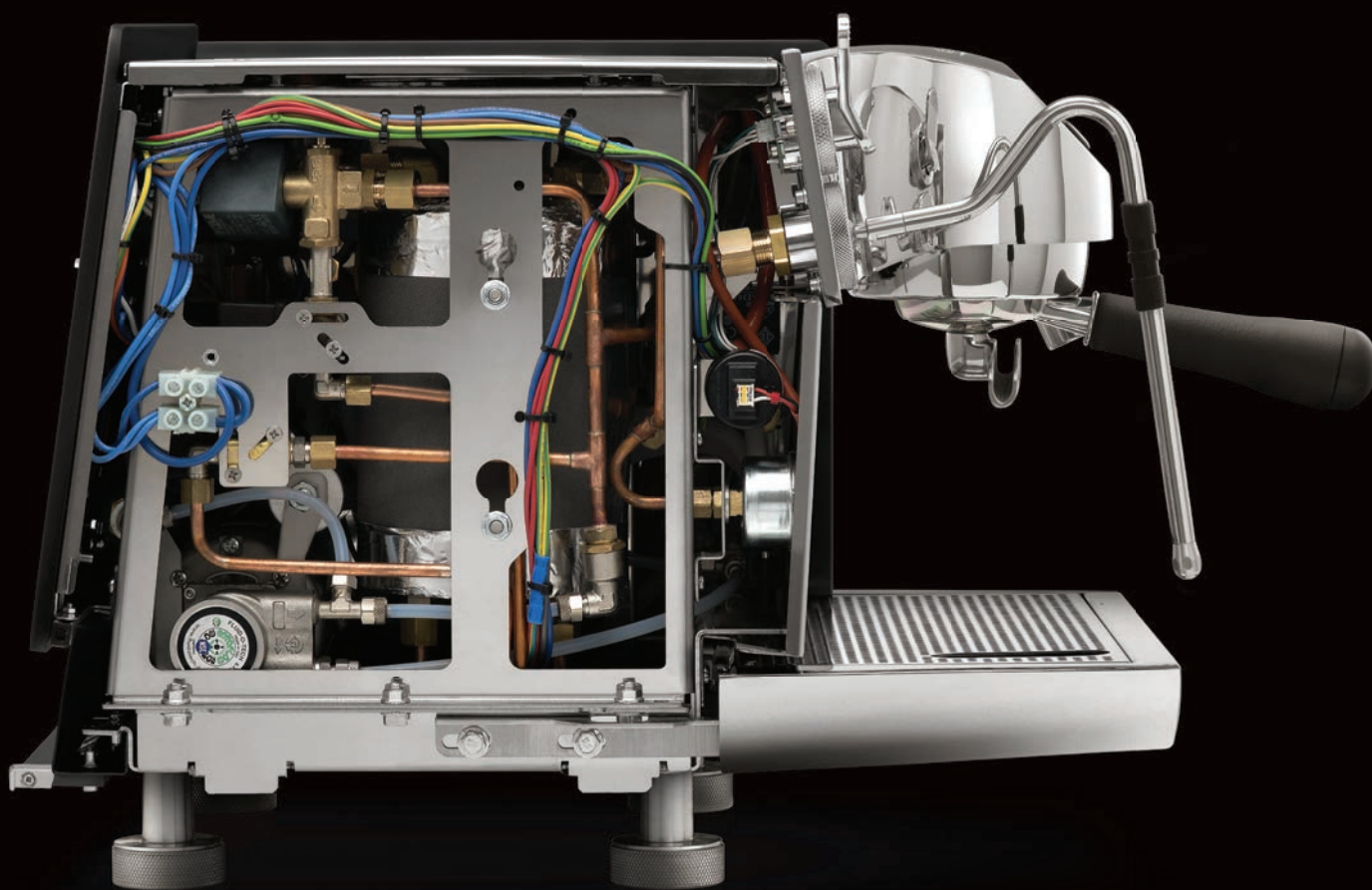

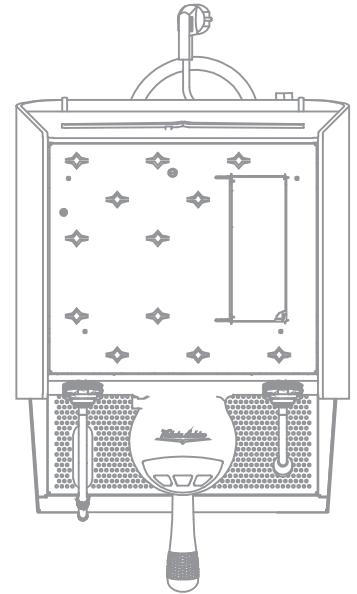
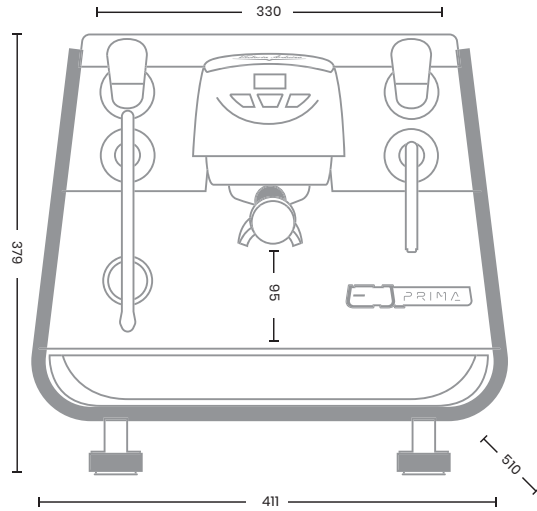
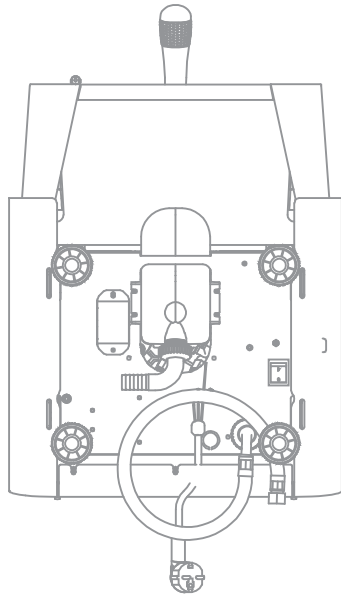

details

REAR AND INTERIOR LIGHTS	included
TANK OR DIRECT CONNECTION	included
AUTOPURGE	included
ECONOMIZER	included
COOL TOUCH	included
BOILER INSULATION	included
STAINLESS STEEL FILTER HOLDER	included
STAINLESS STEEL PAVILLON	included
SHOWERHEAD RINFORCED	included
EASYCREAM	optional
RAISED FEET	optional

measurements

WIDTH	411 mm
DEPTH	510 mm
HEIGHT	379 mm
CUPWARMER	330 x 280 mm
GROUP HEIGHT	95 mm
POWER	min 1600 / max 2600 W



Victoria Arduino

INSPIRED BY YOUR PASSION.

Simonelli Group SpA | Via E. Betti, 1 | 62020 Belforte del Chienti (MC) Italy | P. +39 0733 9501

info@victoriaarduino.com

www.victoriaarduino.com/eagleoneprima

