

# Cyclops 2.0 User's Guide

## Digital Microscope





## Contents

- 1. Product Introduction .....2
  - 1.1 Packing Contents .....2
  - 1.2 Assemble microscope with stand 2
  - 1.3 IR Remote Control .....4
  - 1.4 Microscope Menu Functions .....11
  - 1.5 Microscope Introduction: .....24
  - 1.6 Microscope Focus .....27
  - 1.7 Microscope Accessory .....31
- 2. Printed Notice.....32
  - 2.1 Maintenance.....32
  - 2.2 Product Specification.....33
  - 2.3 Safety Instructions .....34

## 1. Product Introduction

### 1.1 Packing Contents

The box contains microscope and accessories. The Object Lens 4X is already assembled onto microscope.

Item	Q'ty	Item	Q'ty
Cyclops 2.0	1	White Balance Card	1
HDMI Cable	1	IR Remote Control	1
USB-C Cable	1	User's Guide	1
Power adaptor	1	Calibrator	1
S107 Stand	1	Object Lens 4x	1
Stand assemble guide	1	Object Lens 10x	Option
Micro SD Card	Option		

Software D/L: <https://www.aventools.com/software-downloads>

### 1.2 Assemble microscope with stand

#### 1.2.1 Fix microscope

Tighten the microscope onto stand<sup>Ⓐ</sup>. Refer to Stand assembling instruction for detailed explanation.

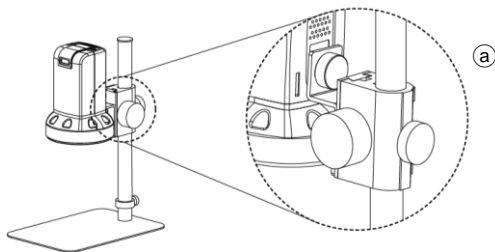

### 1.2.2 Start to use microscope

Connect the HDMI cable**⑥** and adaptor**⑦** to HDMI monitor and power. Microscope will turn on when Power in.

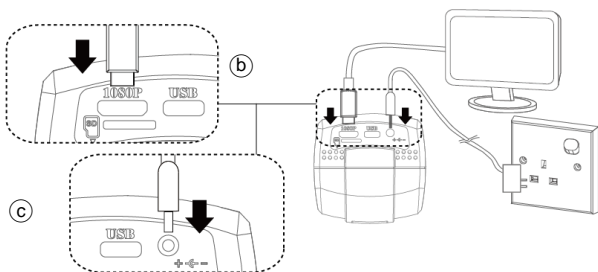

### 1.2.3 Power On/Off

Press Power  to turn on microscope. Choose HDMI mode to output image.

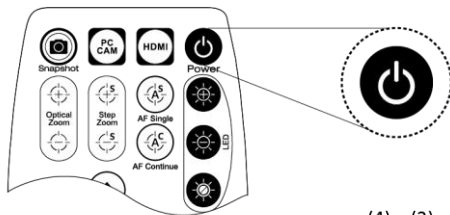

### 1.3 IR Remote Control

The microscope operation and functions is controlled by the IR remote control.









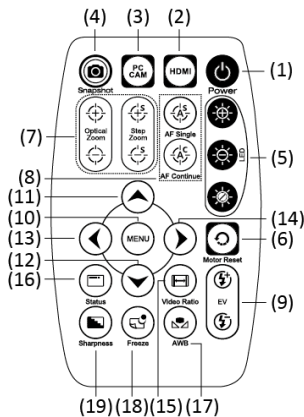



\*Long press means press and hold the button for 2 seconds\*









(1) Power  : Turn on/off.

(2) HDMI  : Picture and Video



Playback function. Video only show first frame, not the whole video.



- (3) PC CAM  : Long Press to switch and enter USB DISK or PC CAM mode. See below (16-4) for details.
- (4) Snapshot  : Press to snapshot or stop video recording;  
Long press to start video recording.
- (5) LED Adjustment: 12 levels of brightness.
- (5-1) Increase  : Increase LED brightness.
- (5-2) Decrease  : Decrease LED brightness.
- (5-3) On/Off  : Turn the LED on/off. When turn on the LED, the brightness will return to the situation before turn off.
- (6) Motor Reset  (Recalibrates entire operation) : Returns to the lens position. If a loss of electricity occurred during operation, please reset the operation.
- (7) Manual focus
- (7-1) Zoom in  : Zooms in; speed increases when held.
- (7-2) Zoom out  : Zooms out; speed increases when held.
- (7-3) Step zoom in  : zoom in by steps.
- (7-4) Step zoom out  : zoom out by steps.
- (8) Autofocus: Press one time to search focus in current area, long press for 2 seconds to search focus in whole area.
- (8-1) Single Autofocus : Focuses one time.
- (8-2) Continuous Autofocus :Re-focuses when image blurred.

- (9) Exposure Value: 20 levels of exposure value are selectable, from -10~Auto~+9.
- (9-1) Increase : Use to increase exposure when the image is too dark.
- (9-2) Decrease : Use to decrease exposure when the image is too bright.
- (10) Menu on Screen : Open/close menu for setting. Menu function refer to Section 1.4. In Playback mode, press to switch play image or video.
- (11) Up : Choose the previous item, if Crosshair is ON, select other color. In Playback mode, press to enter next 10 files.
- (12) Down : Choose the next item, if Crosshair is ON, select other color. In Playback mode, press to enter last 10 files.
- (13) Left : Choose the next value, if Crosshair is ON, select Line Size. In Playback mode, press to preview next file.
- (14) Right : Choose the last value. When MENU function is not turn on, press to change Crosshair in Full screen size, normal size or turn off. In Playback mode, press to enter last file.
- (15) Video Ratio : Digital Zoom function: X1.0, x2.0, x3.0 and x4.0.



- (16) Status Bar  : Status bar tells  Field of View (FOV), Magnification (MAG), and Working Distance (WD) or ON/OFF the status. The area  tells the operation status and only show 3 seconds.

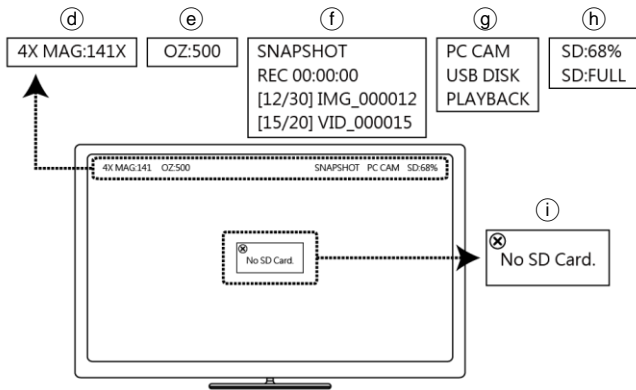

(16-1) Area  :

(16-1-1) FOV : Field of View (FOV) display image on the effective horizontal size of screen.

(16-1-2) MAG : (Magnification) The magnification size will

change depending on the lens position, screen size, and image ratio.

(16-1-3) WD: Working Distance.

(16-2) Area@ :

(16-2-1) OZ : Optical Zoom. Ex: OZ : 500, 500 means sensor position.

(16-2-2) SZ : Step Zoom. Ex :SZ : 500. Same format as OZ.

(16-2-3) AFS : Single Autofocus. Ex: AFS▶A500, “A” means search focus in “current area”, 500 means sensor position. AFS▶W500, “W” means search focus in “whole area”.

(16-2-4) AFC : Continuous autofocus, “A” and “W” are same function as AFS.

(16-2-5) LED : LED levels. Ex: LED : 12, 12 means the LED level.



(16-2-6) EV : Exposure Value. Ex: EV : +5, means EV is +5, EV : -5 means EV is -5.

(16-2-7) MR : Motor Reset.



(16-2-8) DZ: Digital Zoom. Ex:DZ: x4.0 means 4times enlarge.

(16-2-9) SHA : Sharpness. Ex: SHA▶SET(50), means sharpness is 50; SHA▶SET(10) means the max 255.



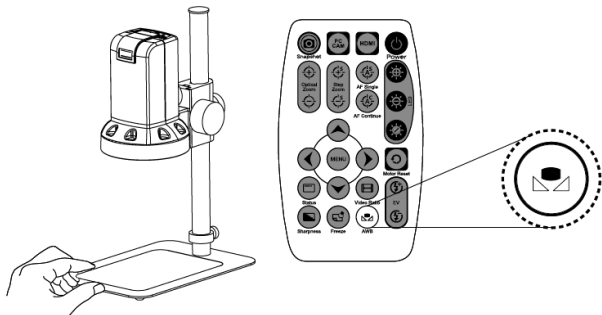





- (16-2-10) FRZ : Image Freeze. Ex: FRZ▶ ON, means freeze image, FRZ▶ OFF means unfreeze image.
- (16-2-11) WB : White Balance Calibration. Ex: WB▶ SET means calibrate white balance.
- (16-3) Information ⓘ: IN PCCAM or PLAYBLACK Mode, the shown info are as following:
- (16-3-1) SNAPSHOT: Take Picture.
- (16-3-2) REC 00:00:00: Video Recording, each video recording max 30mins.
- (16-3-3) [12/30] IMG\_000012: Picture Playback mode.
- (16-3-4) [15/20] VID\_000015: Video Playback mode.
- (16-4) Function mode ⓘ: Show the current operate mode.
- (16-4-1) PC CAM: able to connect with PC software and preview on HDMI monitor.
- (16-4-2) USB DISK: Long press  for 2 sec., wait about 15 sec., Monitor will switch to show USB DISK. User can directly read the SD card file on PC. Snapshot and video recording function is disabled under this mode.
- (16-4-3) PLAYBACK: Play the pictures and video. Snapshot and video recording function is disabled under this mode.





- (16-5) SD Card info  : SD Card memory.
- (16-6) Message  : Show caution information. Ex: when take picture without SD card, the Message will show “No SD Card”.
- (17) Auto White Balance Calibration  : To calibrate the white balance, place the white balance card under the lens, focus until clear, and press AWB. Sometimes the white balance is influenced by external light sources, it is recommended to calibrate the white balance if the color seems off or incorrect.



- (18) Image Freeze  : ON/Off to freeze or unfreeze the image.
- (19) Sharpness  : On/Off to set sharpness at Minimum and Maximum level.

## 1.4 Microscope Menu Functions

Press  button to enter Setup, press Up  and Down  to choose item, Left  and Right  to turn on/off or adjust parameter. Enter  means more functions, press Menu  to enter next function or confirm. Return is Return to last page, or press Left  or Right  to choose "Exit" to the preview window.

Setup	
1.Exposure	
2.Back Light	OFF
3.White Balance	ATW
4.NR	
5.SPECIAL	
6.Video Adjust	
7.Reset	
8.Exit	Exit

### 1.4.1 Exposure

To set exposure time, see below:

Exposure	
1.Digital Shutter	AUTO
2.Video Brightness	20
3.D-WDR	ON
4.DEFOG	OFF
5.RETURN	RETURN

- (1) Digital Shutter: Digitally control amount of light, the amount is smaller the image is darker and the frame rate is also slower.
- (2) Video Brightness: Adjust image brightness.
- (3) D-WDR: Digitally adjusting exposure in areas of the frame to maintain optimum detail in both the shadows and highlights of the image.
- (4) DEFOG: De-Fog. When observing under strong light or special environment, use Defog function to see clear image. Below fig for De-Fog setting. When select AUTO, enter the DEFOG Setting.

DEFOG	
1.GRADATION	OFF
2.DEFAULT	↓
3.RETURN	RETURN

- (4-1) GRADATION: To set gradation levels near the edge of defog area.
- (4-2) DEFAULT: Return to factory setting.
- (4-3) RETURN: Choose from RETURN/EXIT (Auto Save Setting) or Return/Exit without Save setting.

## 1.4.2 BLC

Press left/right button to choose turn on/off Backlight compensation mode.

(1) OFF :Disable backlight function.

(2) BLC (Back Light Compensation)

To adjust brightness for darker image in back light environment.

BLC	
1.BLC Gain	LOW
2.Area Select	↓
3.DEFAULT	↓
4.RETURN	RETURN

(2-1) BLC Gain: To adjust brightness level.

(2-2) Area Select: Choose the back light compensation area and size.

(2-3) DEFAULT: Return to factory setting.

(2-4) RETURN: Choose from RETURN/EXIT (Auto Save Setting) or Return/Exit without Save setting.

### 1.4.3 Manual WB

Calibrate the white light balance, to find out right White color.

- (1) AWB: Auto white balance.
- (2) ATW: Trace white area on the sample and auto-calibrated.
- (3) AWC->SET :Semi-auto white balance. Use to track the white color from current image. (Same as 1.3, (17) operation)
- (4) MANUAL: Manually adjust blue and red values to find correct white color. Refer to below fig.

Manual WB	
1.Blue	560
2.Red	440
3.DEFAULT	⏴
4.RETURN	RETURN

### 1.4.4 NR

Noise Reduction : (NR) To obtain high quality output image and increase file compression. See below:

2D/3D NR	
1.2DNR	ON
2.3DNR	ON ⏴
3.RETURN	RETURN

- (1) 2D NR : ON/OFF, Edge Preserving 2D NR.



- (2) 3D NR: ON/OFF, Motion Adaptive 3D NR. Set Noise Reduction level.

3DNR	
1.LEVEL	100
2.DEFAULT	┆
3.RETURN	RETURN

- (3) RETURN : Choose from RETURN/EXIT (Auto Save Setting) or Return/Exit without Save setting.

#### 1.4.5 SPECIAL

Set special functions:

SPECIAL	
1.D-EFFECT	┆
2.Motion Detection	┆
3.Crosshair	┆
4.Language	English
5.DEFECT	┆
6.VERSION	┆
7.Format SD Card	OFF
8.Resolution	1920x1080
9.RETURN	RETURN

- (1) D-EFFECT : Functions as following: Press Left ⏪ or right ⏩ to turn on or off.

D-EFFECT	
1.Video Freeze	OFF
2.Mirror	OFF
3.ZOOM	OFF
4.DIS	OFF
5.RETURN	RETURN

- (1-1) Video Freeze: ON/OFF to freeze image.  
(1-2) Mirror: Image rotatory. (Horizontal or Vertical)  
(1-3) Zoom: Digital zoom in the selected area. Zoom size from x1~x4.

ZOOM	
1.ZOOM	x1.0
2.Horizontal/Vertical Move	⏴
3.DEFAULT	⏵
4.RETURN	RETURN

- (1-3-1) Zoom: Select digital zoom.  
(1-3-2) Horizontal/Vertical Move: Set zoom area.  
(1-3-3) DEFAULT: Return to factory setting.

(1-3-4) RETURN : Choose from RETURN/EXIT  
(Auto Save Setting) or Return/Exit without  
Save setting.

(1-4) DIS: Digital Image Stabilization function.

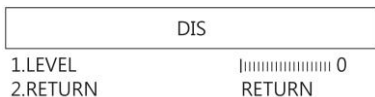

(1-4-1) LEVEL: Select Stabilization level.

(1-4-2) RETURN: Choose from RETURN/EXIT  
(Auto Save Setting) or Return/Exit without  
Save setting.

(1-5) RETURN: Choose from RETURN/EXIT (Auto Save  
Setting) or Return/Exit without Save setting.

(2) Motion Detection: Detect the moving object, see below  
setting.

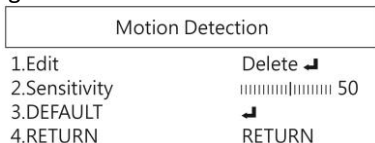

- (2-1) Edit: Delete or add a detective area.
- (2-2) Sensitivity: The sensitivity to detect whenever object moves. The lower value gets the higher sensitivity.
- (2-3) DEFAULT: Return to factory setting.
- (2-4) RETURN: Choose from RETURN/EXIT (Auto Save Setting) or Return/Exit without Save setting.

- (3) Crosshair: Set the Horizontal and Vertical Lines on the display. Calibrate the line distances by using calibrator. The calibrated lines can be reference scale.

Crosshair	
1.Horizontal	OFF
Position	0 5 3 9 / 1080 ↵
Size	.....  1
Color	☒  ...  1
Count	.....  1
Spacing	0 0 4 0 / 1080 ↵
2.Vertical	OFF
Position	0 9 5 9 / 1920 ↵
Size	.....  1
Color	☒  ...  1
Count	.....  1
Spacing	0 0 4 0 / 1920 ↵
3.RETURN	RETURN

(3-1) Horizontal:

(3-1-1) ON/OFF: Display the Horizontal line.

(3-1-2) Position: Set the first horizontal line as origin.

(3-1-3) Size: Line width.

(3-1-4) Color: Black, White, Yellow, Blue, Green, Pink, Red and Blue.

(3-1-5) Count: Show count numbers. Maximum 30 counts.

(3-1-6) Spacing: Distance between lines.

(3-2) Vertical:

(3-2-1) ON/OFF: Display the Vertical line.

(3-2-2) Position: Set the first vertical line as origin.

(3-2-3) Size: Line width.

(3-2-4) Color: Black, White, Yellow, Blue, Green, Pink, Red and Blue.

(3-2-5) Count: Show count numbers. Maximum 50 counts

(3-2-6) Spacing: Distance between lines.

(3-3) RETURN: Choose from RETURN/EXIT (Auto Save Setting) or Return/Exit without Save setting.

(4) LANGUAGES: 16 languages are selectable.







Video Adjust	
1.Sharpness	50
2.Saturation	50
3.Contrast	50
4.DEFAULT	⏴
5.RETURN	RETURN

- (1) Sharpness: Adjust Sharpness, higher value increases the higher contrast along/near edges of the image.
- (2) Saturation: Adjust image saturation.
- (3) Contrast: Adjust image contrast.
- (4) DEFAULT: Return to factory setting.
- (5) RETURN: Choose from RETURN/EXIT (Auto Save Setting) or Return/Exit without Save setting.

#### 1.4.7 Video Adjust

Reset all parameter to factory setting.

Video Adjust	
1.Factory Reset	Reset ⏴
2.RETURN	RETURN

#### 1.4.8 Return:

Exit the menu directly. Press left ⏴ and right ⏵ button to choose exit from menu but not save any setting.

## 1.5 Microscope Introduction:

### 1.5.1 IR Remote Area/Indicator

When both ⑨ and ⑩ LED indicator blinks, the microscope is in standby mode.

Caution: Please remove the transparent protection sheet on the IR receiver area.

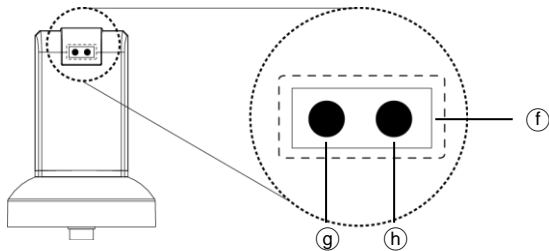

- (1) IR remote control aiming area ⑩ : The indicator will blink whenever buttons are pressed. If the indicator did not blink means the signal was not delivered and please press again.
- (2) HDMI indicator ⑨ : When lit up, the microscope is in HDMI mode. If light blinks, means microscope does not connect with monitor.

- (3) Remote control indicator<sup>Ⓢ</sup>: The indicator will lit up when enable Distance Control Toolbar in PC software, lit off when disable the toolbar.

#### 1.5.1 Power/USB/HDMI/Micro SD port

Caution: Please hold the cable when remove from microscope and do not disassemble cables forcefully.

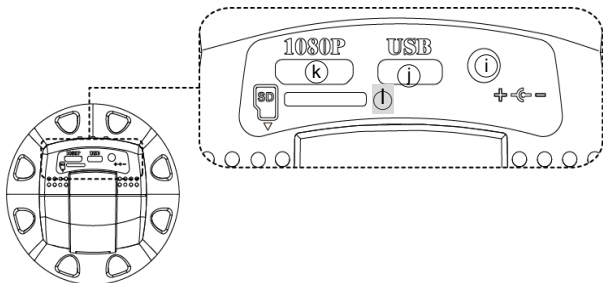

- (1) HDMI<sup>Ⓢ</sup> : The HDMI port is used to connect the microscope to a screen. When the device is in HDMI mode, connect the microscope to the screen using the HDMI cable from the box.  
\* For TV screen connections, make sure to choose the homologous image ratio and format.
- (2) USB<sup>Ⓢ</sup> : USB port to use optional accessory IMB04 to PC.
- (3) Power<sup>Ⓢ</sup> : It's only compatible with the cord in the box.

(4) Micro SD① : Insert SD card to save snapshot and video record.

### 1.5.2 Stand gear box

Assemble the stand and then screw the microscope onto the universal joint ③ on the gear box.

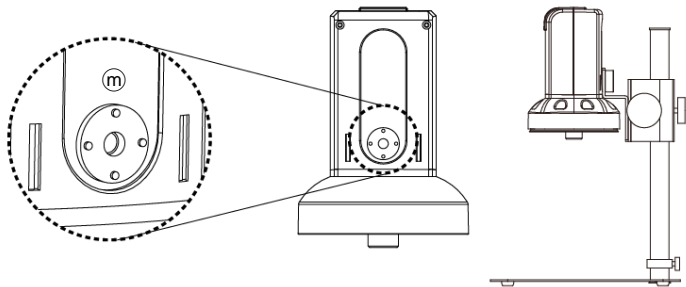

### 1.5.3 LED/ Light socket

- (1) LED④ : Provides luminance for object lens 4x;  
total 30 LEDs.
- (2) Light socket⑤ : Provides luminance for object lens 10x.  
(Optional accessory)

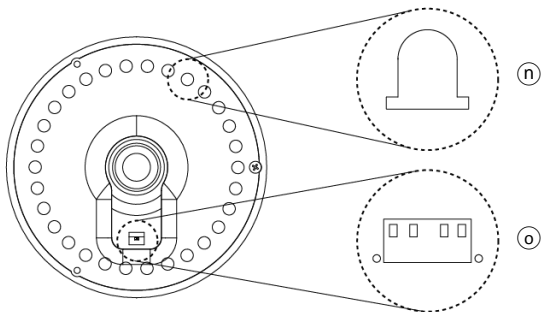



## 1.6 Microscope Focus

There are two ways to focus. First, choose focus distance to adjust the microscope height, then tuning focus by remote controller until clear. On the contrary, first to choose the image sensor position then adjusts the microscope height.



- Focus distance: distance from object lens to object.
- Image sensor position: The image sensor position.

### 1.6.1 Focus Techniques

#### (1) Fixed focus distance

Use knob  or  to adjust the distance from the object lens to the object. When the distance is closer, the magnification size is higher. When the focus distance is fixed, use the remote controller or far distance control mode on the application program to focus the image.

#### (2) Fixed image sensor position

The status bar will show on the screen (please refer to Section 1.3-(16)). Use the remote controller to adjust the image sensor position based on magnification size, FOV, or working distance. When the image sensor position is fixed, focus the image by using knob  to adjust the height and knob  to fine tune.

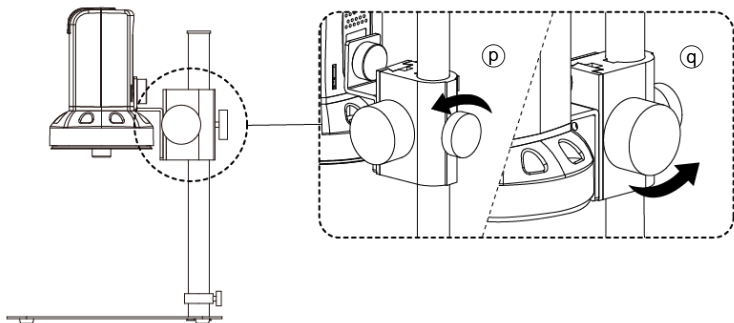

### 1.6.2 Magnification chart

26 focus section setting is based on the whole focus area per 4x object lens. 10x object lens only have 14 focus sections. The sensor position tells the magnification size(Mag.), field of view(FOV), or working distance(WD). The below chart is measured on 4:3 ratio on 24" screen, it's only a reference data, might not be accurate enough. Based on the image ratio (preview window size), field of view and magnification size will change.

(1) 4X object lens, focus distance from 22mm~214mm(0.866~8.425inch).

4X object lens on 24" (Reference data)

Focus section	1	2	3	4	5	6	7	8	9
Sensor position	1620	1595	1565	1520	1455	1420	1375	1350	1315
WD(mm)	214	187	161	134	108	97.0	86.5	81.5	76.0
FOV(mm)	40	35	30	25	20	18	16	15	14
Mag. (X)	13.2	15.1	17.7	21.2	26.5	29.5	33.2	35.4	37.9
Focus section	10	11	12	13	14	15	16	17	18
Sensor position	1280	1240	1190	1130	1095	1055	1015	965	910
WD(mm)	70.5	65.5	60.0	55.0	52.0	49.5	47.0	44.0	41.5
FOV(mm)	13	12	11	10	9.5	9	8.5	8	7.5
Mag. (X)	40.8	44.2	48.3	53.1	55.9	59.0	62.5	66.4	70.8
Focus section	19	20	21	22	23	24	25	26	
Sensor position	850	775	695	595	475	330	150	60	
WD (mm)	39.0	36.5	33.5	31.0	28.5	26.0	23.0	22.0	
FOV(mm)	7	6.5	6	5.5	5	4.5	4	3.8	
Mag. (X)	75.9	81.7	88.5	96.6	106	118	133	140	



10X object lens, focus distance from 6.3mm~10mm(0.248~0.393inch)

10X object lens on 24" (Reference data)									
Focus section	1	2	3	4	5	6	7	8	9
Sensor position	1790	1725	1650	1565	1475	1375	1265	1135	985
WD (mm)	10	9.7	9.4	9.1	8.8	8.5	8.2	7.9	7.6
FOV(mm)	2.3	2.2	2.1	2.0	1.9	1.8	1.7	1.6	1.5
Mag. (X)	231	242	253	266	280	295	313	332	354
Focus section	10	11	12	13	14				
Sensor position	815	625	400	135	45				
WD (mm)	7.3	7.0	6.7	6.4	6.3				
FOV(mm)	1.4	1.3	1.2	1.1	1.07				
Mag. (X)	380	409	443	483	497				

## 1.7 Microscope Accessory

### 1.7.1 White balance card

The white side is used to calibrate the white balance. If the object is tiny, place it onto the white balance card and move the card instead of the object.

## 2. Printed Notice

Please read the following information before operating.

### 2.1 Maintenance

Please abide by the following rules while storing or using this product:

- 2.1.1 Keep dry: do not place the product in a humid environment. Dry surroundings help extend the life of the product.
- 2.1.2 Avoid temperature shock: temperature shock (for example, taking the product into a warm room from a cold environment) will cause internal condensation inside the machine. Please put the device inside the protection bag or handbag to prevent temperature shock, and avoid using the device in an environment with extreme temperatures.
- 2.1.3 Avoid dropping: the device may malfunction if it encounters strong collision, vibration, or distortion.
- 2.1.4 Turn the microscope off before cutting off the power supply :do not forced cut off the power supply.
- 2.1.5 Do not face the lens against strong light or sunshine for extended periods of time: Strong light rays may degrade sensitive elements and generate white stains on images.
- 2.1.6 Handle the device carefully: do not disassemble cables forcefully and avoid contact with the lens since they are subjected to damage.
- 2.1.7 Make sure to switch the power supply off and unplug the power cable if the device is not in operation for an extended period of time. Store the device in a dry environment with excellent ventilation. Do not expose the machine in an environment lower than -5°C or higher than 50°C.
- 2.1.8 While carrying, put the device inside the box to prevent from being damaged.

## 2.2 Product Specification

CMOS Sensor	2 million pixels CMOS sensor
Lens	Object lens 4X: 4/0.10,160/0.17; Object lens 10X: 10/0.25,160/0.17
Magnification	Object lens 4X: 13x~140x;10 Object lens : 231x~497x on 24" monitor
Auxiliary source	White LED × 30pcs
DC port	Adaptor DC Input
HDMI port	Output 1080P(1920*1080 Pixel) image
Focus control	IR remote control
Power supplier	Adaptor (Output : DC 5.0V/2.0A Input : AC 100-240V 50/60Hz)
Power Consumption (A/C)	1.6A(Max Current) /8W
Size	106(L)×106(W)×152(T) mm
Weight	Host weight around310 grams
Operation environment	Temperature -5°C ~ 50°C; Humidity-lower than 85% (No Condensation)
For any changes, please visit <a href="http://www.vitiny.com">http://www.vitiny.com</a>	

## 2.3 Safety Instructions

- As an electronic product, please do not use the device in any place in which electronic products are prohibited.
- Keep the device away from water sources to avoid electric shock as it is not waterproof.
- Keep the device away from chemicals or substances with explosive or fire hazards. Switch the device off near gas stations.
- In the case that there are foreign substances or water inside the device, or the device is dropped or damaged, please switch off and remove the power supply to avoid fire and electric shock.
- Do not look steadily into Light sources after switching on the host as it is harmful to your eyes.
- Please use only the product accessories provided in the box for connections. Do not use any outside products without approval of original factory.
- Please remove the power supply from the microscope when not in use.
- Do not disassemble the machine for inspection. For any problems occurring in the machine itself, please power off the device and contact us through e-mail: [mltc@vitiny.com](mailto:mltc@vitiny.com)

**Contents of Warranty:** The warranty is provided free of charge for faults caused by manufacturing within one year from the purchase date.

**Non-warranty:**

1. Product appearance parts, such as the outer casing, knobs and LED cover, etc (charged spare parts are limited to one year after completing the product manufacturing).
2. Consumption goods of the host itself, such as LED lights and lens.
3. Product accessories and fittings, such as the power supplier, HDMI cable, white balance card, remote controller...etc.

Services caused by any of the following situations in the period of the warranty shall not be provided free of charge:

1. Improper use or disassembly, repair or refitting.
2. Any damages to the device caused by external or environmental factors.
3. Discrepancy of product serial number, unfilled or unidentified warranty. Any inspection or repair service after the period of warranty will be charged as follows:
  - (1) Service fees (including transportation fees) of product inspection.
  - (2) Repair fees.
  - (3) Fees of replaced parts

**Aven Tools Tel: 734-973-0099 Fax: 734-973-0097**

Address: 4330 Varsity Drive Ann Arbor, MI 48108

Website: <http://www.aventools.com>

## Aven Cyclops 2.0 Warranty

Product	
Model no	
S/L nos.	
Purchase date	<b>DD/MM/YYYY</b>
Purchaser	
Tel no:	
Address	
Email	
Distributor Seal for Confirmation	
( Stamp is necessary for validation of the Warranty )	
※Distributor's seal shall include name of the shop, telephone and address※	

Please ask the distributor to fill in the name of the shop, address, purchase date, and other contents to protect your rights and validate your one-year warranty since upon the purchase date.





*Tools for  
Advancing  
Innovation™*

[HTTP://WWW.AVENTOOLS.COM](http://www.aventools.com)