



*Tools for
Advancing
Innovation*

Aven Inc
4330 Varsity Drive
Ann Arbor, MI 48108

Phone: 734-973-0099
Email: info@aventools.com
Web: aventools.com



Contents

1. Product Series & Lists -----	2
---------------------------------	---

2. Camera Interface Specification-----	4
--	---

3. Use in PC Mode-----	6
------------------------	---

3.1 Camera Installation-----	6
------------------------------	---

3.2 System Configuration-----	7
-------------------------------	---

3.3 Software Installation-----	7
--------------------------------	---

3.4 Software Settings-----	9
----------------------------	---

4. Use in HDMI Mode-----	13
--------------------------	----

4.1 Camera Installation-----	13
------------------------------	----

4.2 Basic Use -----	14
---------------------	----

5. Precautions-----	17
---------------------	----

6. Maintenance-----	18
---------------------	----

Mighty Cam Auto Focus



Built-in Autofocus
Built-in measuring system
Built-in ISP
Real-time stitching
Real-time EDF
HDMI+USB2.0 interface

Standard lists

1 x Camera
1 x Software (CD/U disk)
1 x SDcard
1 x Mouse
1 x Power adapter(12V 2A)
1 x USB cable
1 x HDMI cable (2m)

2.4 HDMI Cameras

- ① USB ② HDMI ③ Power
④ ON/OFF ⑤ Indicator light ⑥ SD card slot

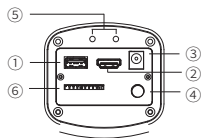

1) USB interface:

A: Connect the mouse to the USB port, the camera can then be controlled directly by the mouse;

B: Or connect the USB port to PC to make the camera work as a Driver-Free camera. Use Mosaic software to control it.

2) HDMI interface: Use the HDMI cable to connect HDMI camera to the screen. Image data is transferred and displayed on the monitor according to the HDMI protocol.

3) Power interface: Please use the provided 12V/2A power supply. When power is plugged in, the red light is on. When camera is switched on, blue light is on.

4) ON/OFF key: Press the ON/OFF key until the blue light is on or off to turn on or off the HDMI camera.

5) SD card: To get faster and more stable data transfer, we recommend you to use a Class10 SD card.

2.5 Optical Interface Description

- ① Standard C-mount optical port ③ Adjustable ring
② Anti-dust seal

Please tear off before installation

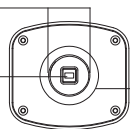

3. Use in PC Mode

3.1 Camera Installation

In PC mode, connect the camera to the computer with a USB cable and use the software to control the camera. It is suitable for all cameras that provide a USB interface. The camera installation is as follows:

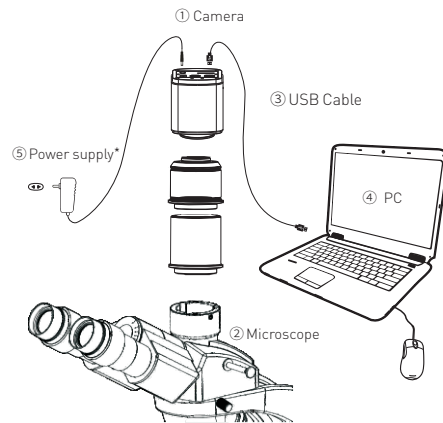

* Note: Some cameras support USB power supply, no need to install additional power supply, please refer to whether the power supply accessories are provided in the accessory list.

3.2 System Configuration Recommendation:

Camera	USB3.0 Series	USB2.0 Series
OS	Windows 7/8/10 (32&64bit)	Windows 7/8/10 (32&64bit)
CPU	Intel Core i5 or better	Intel Core i3 or better
USB ports	Support USB3.0,USB2.0	Support USB3.0,USB2.0
Memory	4GB or more	4GB or more

* Note: When running advanced functions such as "real-time stitching" or "real-time EDF", the camera should be used in 64bit OS and the memory is recommended to be 8GB or more.

3.3 Software Installation

① Connect the camera to the PC. Insert the USB-Stick(or CD) that comes with the camera, copy the software "Mosaic 2.1. exe" to the computer. Double click on it and follow the [Next] button to finish the installation. After [finish], a software shortcut will be created on the desktop.

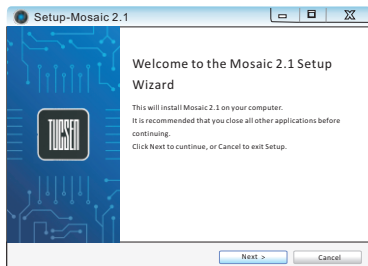

② Go to the Device Manager and check whether the driver is installed properly. If there is NO YELLOW FLAG with the camera under Imaging Devices in Device Manager, the driver is installed successfully. If there is YELLOW FLAG, you need to reinstall the driver.

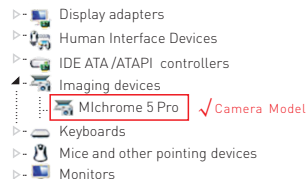

③ Double-click the Mosaic 2.1 shortcut to start the software. When installing and starting up the software for the first time, the biological or industrial application option box will pop up, select your application direction to enter the software. The software will automatically optimize parameter settings based on your choice. While using software, the application direction can also be switched through [Information] - [Options] - [Microscope] on the right upper part of menu bar.

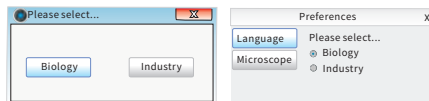

④ The software version number, camera model and computer configuration information can be obtained from the information in the info menu at the top right of the software.

Note: If the camera is connected correctly, the camera device will automatically recognize and enter the preview state when the software is turned on. If the "No Camera" error appears, it could be the camera is not detected by the PC or the driver is not installed properly. Please go to Device Manager to check the camera driver installation status.

3.4 Software Settings

1).Basic Settings

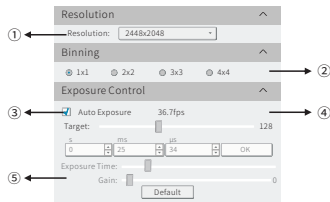

- 1 Click the resolution drop-down box to select the working resolution.
- 2 Binning can improve the sensitivity of the image. The larger the value is, the higher the sensitivity is.
- 3 Observe the preview screen, and select the automatic or manual exposure setting according to the actual application requirements to obtain the desired image intensity. Under industrial application, automatic exposure brightness can be adjusted via manual adjustment of exposure target value based on picture brightness; there's no exposure target value under the biological mode.
- 4 Display and view the live preview frame rate.
- 5 Depending on the application requirements, adjust the gain value to obtain the required image signal enhancement effect.

2).Image Adjustment

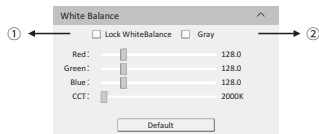

- 1 Under the biological mode, software defaults automatic white balance: Conduct white balance calculation by moving samples under microscope to empty space, and then select [Lock White Balance] to complete white balance calibration operation; Under the industrial mode, by opening white balance options, regional white balance box will pop out on the preview pictures. Under stable lighting environment, move the regional white balance box to any white part of the pictures, then adjust size, and check [Lock White Balance] to lock present white balance, which will make white balance calibration more accurate.
- 2 After selecting [Gray], the preview screen will turn into monochrome mode.

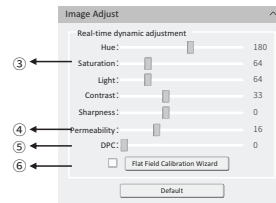

- 3 Hue refers to the shade of the color, saturation is the purity of the color, light is the brightness and darkness of the image, contrast is to adjust the difference of the brightness of the image, and sharpness is to adjust the sharpness of the image edges.
 - 4 When the preview shows a hazy effect, adjust [Permeability] to restore the clear picture.
 - 5 When the preview image has dead pixels and color points, adjust [DPC] the dead pixel correction function to effectively remove the dead pixels to obtain a cleaner image.
 - 6 When the light source is not uniform, or the preview image has dirty spots, use the [Flat Field Calibration Wizard] option to correct the image default background and obtain greater uniformity.
- Note: GT series cameras do not support CCT, Hue, Light.

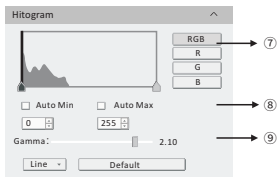

- ⑦ To select R, G, B channel can check grey maps in different channels and also can adjust channel color order individually.
- ⑧ [Auto Min]&[Auto Max] automatically obtains the pixel values of the darkest and brightest intervals with even distribution. [Single channel does not support].
- ⑨ Appropriately adjust the gamma value, change the brightness value of the gray tone of the image, and increase the layering of a monochrome image.

3).Image Stitching and EDF (Live)

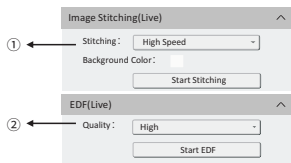

- ① Run the live image stitching, move the stage XY axis according to the selected stitching speed, splice the image to obtain a high resolution image.
 - ② Run the live depth of field expansion, observe the preview picture, rotate the focus knob of the microscope, and fuse different depths of field to finally obtain a clear image effect. Different samples have different qualities of high, medium and low.
- Note: GT series cameras do not support live stitching and depth of field integration.

4).Image Acquisition

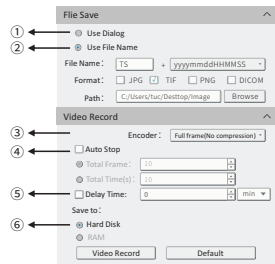

- ① Select [Use Dialog]: the software will pop up the Dialog to set the picture save path, picture name and format when taking pictures.
- ② Select [Use File Name]: A file will be saved with the name "TS" as default, but the name can be customized. "Customized name + time stamp" is supported. A name can contain up to 64 bytes; File format: Support JPG\TIF\PNG\DICOM, default to TIF, and can be checked simultaneously, but at least one of them must be chosen. Under default status, the image file shall be saved to a file folder specified in defined [Path]; user can modify the saving path through [Browse].
- ③ The video provides two encoding modes: [Compression] and [Full frame (No compression)]. [Full frame (No compression)] is chosen as default.
- ④ Select [Auto Stop], the recording mode is available in [Total Frame] and [Total Time]. [Total Frame] is chosen as default. Unselect [Auto Stop], user can manually click to stop the current video recording.
- ⑤ Selecting [Delay Time], you can set a period of time after which video recording will start.
- ⑥ [Hard Disk] In the process of capturing images, the function will automatically write the data into disk. Which is suitable for long-term shooting. [RAM] Save the data into computer memory; after image capturing, write the data into a disc file. Limited by the size of memory space, this mode is not suitable for a long time capturing images.

4. Use in HDMI Mode

4.1 Camera Installation

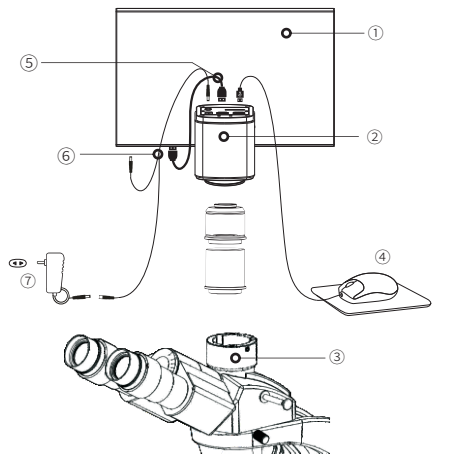

① Retina screen ② HDMI camera ③ Microscope ④ Mouse

⑤ HDMI cable ⑥ Y power splitter cable ⑦ 12V2A Power adapter

4.2 Basic Use

1. After the connection is completed, press ON/OFF key until the blue light is on and the moving cursor appears on the screen.
2. When the cursor is moved to the left of the screen, "Capture" and "Setting" icons will appear. Click "Setting" to get the parameter setting menu.
3. When the cursor is moved to the right of the screen, the shortcut button appears.





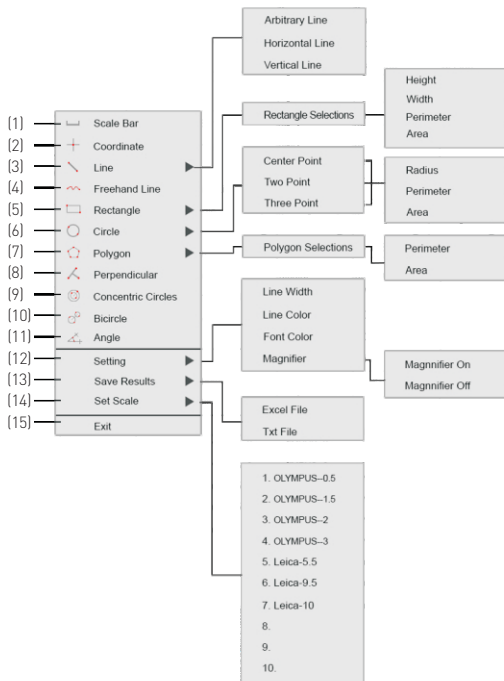

Note: Different models of cameras have different functions. Please refer to the camera's actual function interface.

4. Right-click to enter the calibration and measurement module.



1	Scale Bar	On/off the scale bar on the picture.
2	Coordinate	Get the coordinates of the selected points.
3	Line	Arbitrary, horizontal and vertical line measurement.
4	Freehand Line	Get a freehand line length.
5	Rectangle	Measure rectangle perimeter and area. Selectable to have the data of height, width, perimeter or area.
6	Circle	1) Center Point: Use center point and point on the circle to draw a circle; 2) Two Point: Draw a circle according to the diameter; 3) Three Point: Use 3 points on the circle to draw a circle. Selectable to have the data of radius, perimeter or area.
7	Polygon	Measure polygon perimeter and area. Selectable to have the data of perimeter or area.
8	Perpendicular	Measure the perpendicular length.
9	Concentric circles	Get the diameters of the two concentric circles.
10	Bicircle	Get the distance between two circles' center points.
11	Angle	Measure the angle.
12	Setting	1) Set the measurement line width, color and font color. 2) Magnifier On/off: Switch on/off the magnifier. (When the magnifier is switched on, the cursor located area will be zoomed in and placed at the corner to help accurately locate the measurement point.)
13	Save Results	Select to export the measurement results to an excel or text file. The exported results will be saved in the SD card\MEASURE folder.
14	Set Scale	It allows to create 10 groups calibration files in calibration table, and the user can select 10 groups files to do measurement.
15	Exit	Exit the measurement.

5. Precautions

 CAUTION	
	Do not disassemble, repair or modify on your own. Otherwise it will cause damage to the camera chip or devices on the circuit board.
Do not disassemble	
	Avoid allowing the camera to get wet, since this may cause the failures such as circuit board device corrosion, burnout and so on.
Do not contact water	
	Avoid physical impacts such as dropping or banging.
Do not subject the camera to physical shock	
	Unplug the data cable, then request AVEN to have the authorized dealer or sales for repair.
Immediate repair request	

Note: Man-made damage including self-disassembly, water ingress, physical shock and so on is not within the scope of warranty.

6. Maintenance

1. Avoid removing the lens cap in a dusty environment.
2. When removing the lens cap or mounting a lens, hold the camera face down to prevent dust from falling on the sensor surface.
3. When the camera is not being used, the lens cap should be replaced.
4. Use a professional dust removal tool to remove any dust on the camera optical filter.
 - ① If dust gets on the filter, it should be removed using low pressure air.
 - ② For stubborn oily dust, the surface can be gently wiped using a lint-free cotton swab dipped in ethanol.
5. If it still cannot be cleaned, contact the after-sales personnel for assistance. The use of non-professional equipment for cleaning is prone to lead to scratches on the filter surface.
6. Use only the original power adapter. Ensure the adapter and associated cables are free from items that may cause damage. If the power adapter is damaged, please contact the supplier for an immediate replacement.