



HydroChem

Conductivity and pH Controller

Date:16-Feb-2011

Version: 4.1

TPS Pty Ltd

ABN 30 009 773 371

Phone: (07) 32058027

International: 61 732058027

Email: sales@tps.com.au

Web: www.tps.com.au





Congratulations !

The **hydroCHEM** is a high quality, precision Conductivity and pH controller and is designed for maximum reliability to give you many years of service.

Despite its impressive list of features, the **hydroCHEM** is a breeze to operate. This manual has been designed to help you get started, and also contains some handy application tips. If at any stage you require assistance, please contact either your local TPS representative or the TPS factory in Brisbane.

The manual is divided into the following sections:

1. Table of Contents

Each major section of the handbook is clearly listed. Sub-sections have also been included to enable you to find the information you need at a glance.

733066976. Introduction

The introduction has a diagram and explanation of the display and controls of the **hydroCHEM**. It also contains a full listing of all of the items that you should have received with the unit. Please take the time to read this section, as it explains some of items that are mentioned in subsequent sections.

733067032. Main Section

The main section of the handbook provides complete details of the **hydroCHEM**, including operating modes, calibration, troubleshooting, specifications, and warranty terms.

733067200. Appendices

Appendices containing background information and application notes are provided at the back of this manual.



Contents

1. Introduction	5
1.1 hydroCHEM Display and Controls	6
1.2 hydroCHEM Connectors	6
1.3 Menu Key	6
1.4 Function Keys	7
1.5 Enter Key	7
1.6 Help Key	7
1.7 Shift Key	7
1.8 Arrow Keys	7
1.9 80 Character Display	7
1.10 Unpacking Information	7
1.11 hydroCHEM Menu Structure	8
2. Limits Set-up	10
2.1 Setting the Control Limits	11
2.2 Control Direction	11
2.3 Control Sensitivity	12
2.4 Control Limit Set-up examples	13
2.5 Alarms	14
3. Control Set-up	19
3.1 Setting up the Conductivity control function	20
3.2 Setting up the pH control function	20
3.3 Selecting Automatic Control or Standby Modes	21
4. Quick-Dose Function	21
5. Flow Sensing	22
5.1 hydroCHEM-DS Flow Sensing	23
5.2 hydroCHEM Flow Sensing	23
6. Temperature Calibration	25
6.1 Temperature Calibration Procedure	26
6.2 Temperature Calibration Notes	26
6.3 Temperature Calibration Messages	26
7. Conductivity Calibration	26
7.1 Conductivity Calibration Procedure	27
7.2 Conductivity Calibration Notes	28
7.3 Conductivity Calibration Messages	29
8. TDS Calibration	29
8.1 TDS Calibration Procedure	30
8.2 TDS Calibration Notes	31
8.3 TDS Calibration Messages	32
9. pH Calibration	32
9.1 pH Calibration Procedure	33
9.2 pH Calibration Notes	34
9.3 pH Calibration Messages	34
10. Setting up the Sample Chamber	35



10.1 Connecting the tubing	36
10.2 Adjusting the Flow Rate	37
11. Peristaltic Pumps	39
11.1 Commissioning the Peristaltic Pumps	40
11.2 Lubricating the Pump Tubing	42
11.3 PumpFault Error Message	42
11.4 Replacing the Pump Tubing	43
12. Control Outputs	45
12.1 Output Cable Connections	46
12.2 Control Output Specifications	46
13. Password Security	46
13.1 Enabling the Password Security function.	46
13.2 Using the Password Security function	46
13.3 Changing the Password	47
13.4 Disabling the Password Security function	47
14. Good Laboratory Practices (GLP)	47
14.1 Recalling Calibration information on the display	48
14.2 Printing Calibration information to the RS232 Port	48
14.3 Recalling System information on the display	49
14.4 Printing System information to the RS232 Port	52
14.5 Failed Calibration	53
14.6 Instrument Serial Number	54
14.7 Additional GLP Features	54
15. Datalogging Function	54
15.1 Recording readings manually	55
15.2 Recording readings automatically	55
15.3 Recalling Readings from the Notepad	56
15.4 Erasing Records from the Notepad	57
15.5 Printing Records from the Notepad to the RS232 Port	58
16. RS232 Port	58
16.1 Setting the Baud Rate	59
16.2 Sending Readings to the RS232 Port	59
16.3 RS232 Configuration	59
16.4 Communication and Statistical Software	59
16.5 Commands	59
16.6 Data Format	60
16.7 GLP Data Format	63
16.8 Importing Data into Microsoft Excel	64
17. Setting the Clock	67
18. Selecting the Conductivity/TDS units	68
19. Selecting Display Resolution	69
20. Emergency ShutOFF timer	70
20.1 Procedure in event of ShutOFF timer being tripped	71
21. Selecting Buffers for Auto Buffer Recognition	72
22. Resetting the hydroCHEM	73



22.1 Resetting the Calibration information only	74
22.2 Resetting the Full System information	74
22.3 Factory Default System Settings	74
23. Instrument firmware version number	75
24. Troubleshooting	75
24.1 General Errors	76
24.2 Conductivity / TDS Troubleshooting	76
24.3 pH Troubleshooting	77
24.4 Temperature Troubleshooting	78
24.5 Pump Troubleshooting	78
25. Appendices	79
25.1 Mounting the hydroCHEM	80
25.2 Care and Cleaning of Conductivity Sensors	80
25.3 pH Electrode Fundamentals	80
25.4 hydroCHEM Specifications	83
26. Warranty	86

1. Introduction

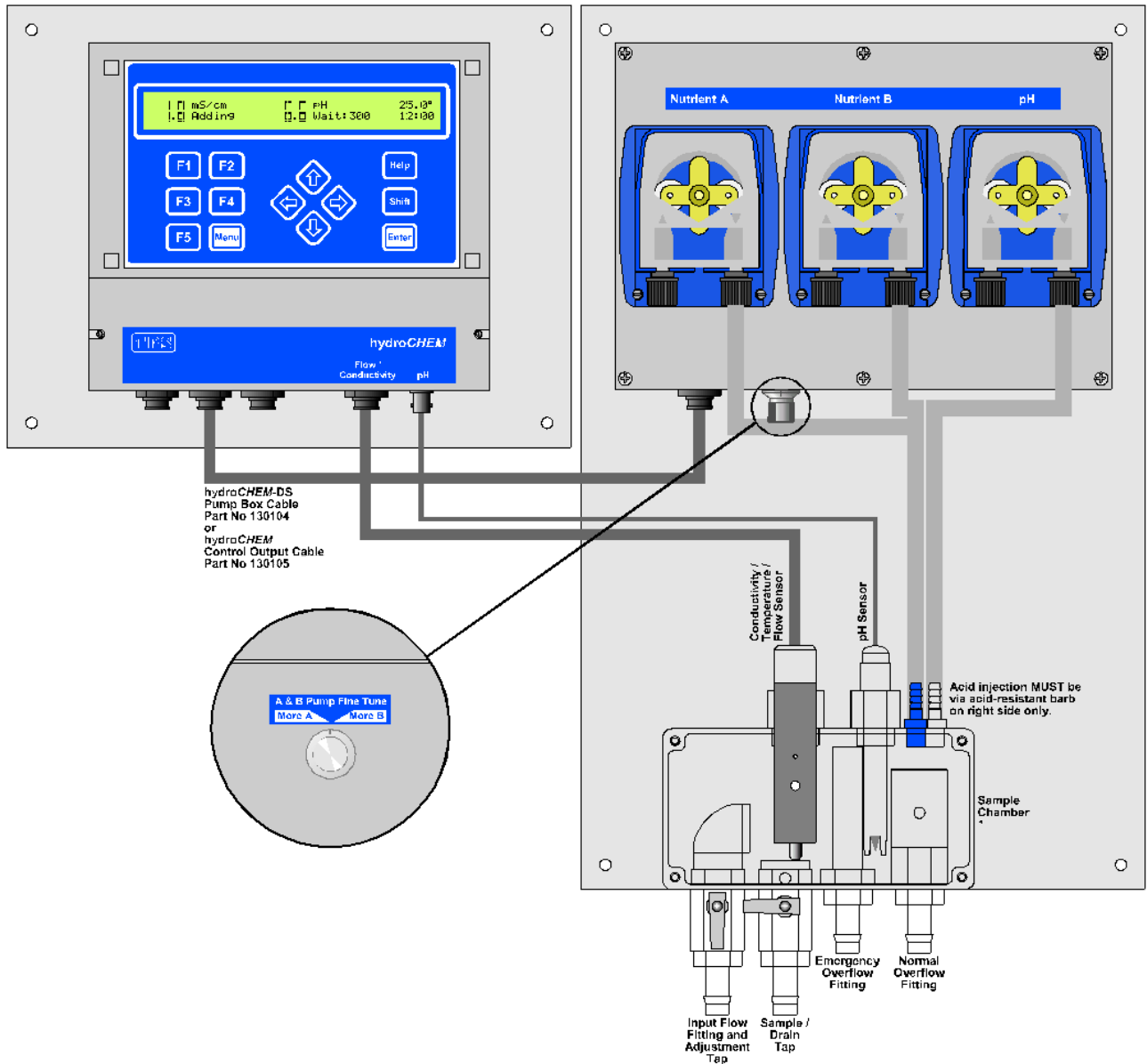

1.1 hydroCHEM Display and Controls



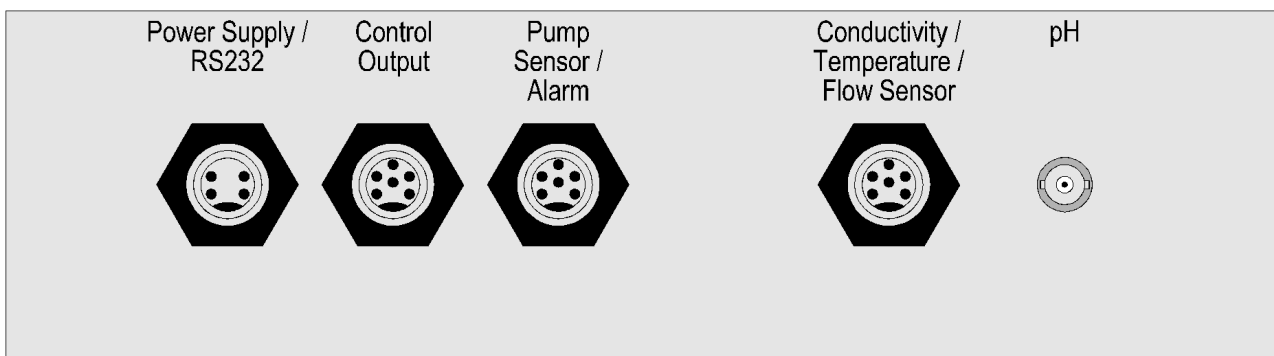





1.2 hydroCHEM Connectors



1.3 Menu Key

- Press the  key to access the user-friendly menu system.
- Press the  key to quit without saving changes when entering data.

1.4 Function Keys

- Press the  to  function keys to select desired options within the menu system.
- These keys perform the following function directly in normal display mode...
 -  : Press to record readings into the Notepad, when the Plus-Pack is fitted. See section 15.
 -  : Press to transmit current reading plus date and time to the RS232 port, when the Plus-Pack is fitted. See section 16.2.
- Press the  to  to enter a password when the security function is enabled. See section 12.





1.5 Enter Key

Press the  key to accept default values or save changes when entering data.





1.6 Help Key

Press the  key to obtain context-sensitive help messages.

1.7 Shift Key

- Press the  key to alternate between standard display and large digit display. See section 1.9.
- Press and hold the  key while scrolling data with the  and  keys to speed up the scrolling rate.

1.8 Arrow Keys

- Press the  and  keys to scroll values up and down when entering or displaying data.
- Press the  and  keys to move the cursor left and right when setting the calendar clock, when Plus-Pack is fitted. See section 17.

1.9 80 Character Display

- 80 character alphanumeric display with user-friendly menu and context-sensitive help system.
- Standard display mode shows Conductivity and pH data, limits and control status. Temperature data is also displayed. The current time is displayed when Plus-Pack is fitted. For example...

1.8mS/cm (2.0)	6.6pH (6.5)	22.0°C
Adding	Wait:300	12:00

- Large digit mode shows Conductivity and pH in double height digits. Control status and Temperature data are displayed in standard digits. The current time is displayed in standard digits when Plus-Pack is fitted. For example...

0 mS/cm	0 pH	25.0°
.0 Adding	0.0 Wait:300	12:00



1.10 Unpacking Information

Before using your new **hydroCHEM**, please check that the following accessories have been included:

	Part No
<i>Standard hydroCHEM Kit...</i>	
1. hydroCHEM Hydroponics Controller	111103
2. 4 Terminal Conductivity Sensor, 5m cable	122215
3. Gel-filled Submersible pH Sensor, 5m cable	111224
4. Inductive pump sensor	130102
5. pH4.01 Buffer, 200mL	121381
6. pH7.00 Buffer, 200mL	121387
7. 2.76mS/cm Conductivity Standard, 200mL	122306
8. Control output cable for A, B and pH Pumps, 5m	130105
9. 24V DC Plug-Pack Power Supply (or other to suit country of destination)	130106
10. hydroCHEM Handbook	130050
<i>hydroCHEM-DS Kit</i>	111109
1. hydroCHEM Hydroponics Controller (Pre-fitted onto mounting panel)	111103
2. Dosing panel with 3 peristaltic pumps and sample chamber	116320
3. 4 Terminal Conductivity Sensor	122205
4. Gel-filled pH Sensor	121227
5. pH4.01 Buffer, 200mL	121381
6. pH7.00 Buffer, 200mL	121387
7. 2.76mS/cm Conductivity Standard, 200mL	122306
8. 24V DC Plug-Pack Power Supply (or other to suit country of destination)	130106
9. Control output cable for A, B and pH Pumps, 1m	130104
10. 3 x 2 metres of Flexible Input/Output Tubing	116360/2
11. 3 x weights for feed drums for each pump	116354
12. 10 metres of 13mm Black Poly Tubing	NPH.5
13. 4 x 13mm Poly Tube Clips	NC13
14. hydroCHEM Handbook	130050
<i>Options that may have been ordered with your hydroCHEM...</i>	
1. Plus-Pack option (includes RS232 cable)	130100
2. Communication software for Windows 95 & 98	130086
<i>Other spares...</i>	
1. Peristaltic Pump tube replacement assembly	116352
2. Syringe of Lubricant for Peristaltic Pump Tubing	130103
3. RS232 Interface Cable	130041

1.11 hydroCHEM Menu Structure

A detailed breakdown of the menu system of the **hydroCHEM** is shown below. This diagram provides a quick reference for the menu functions available for the **hydroCHEM**.

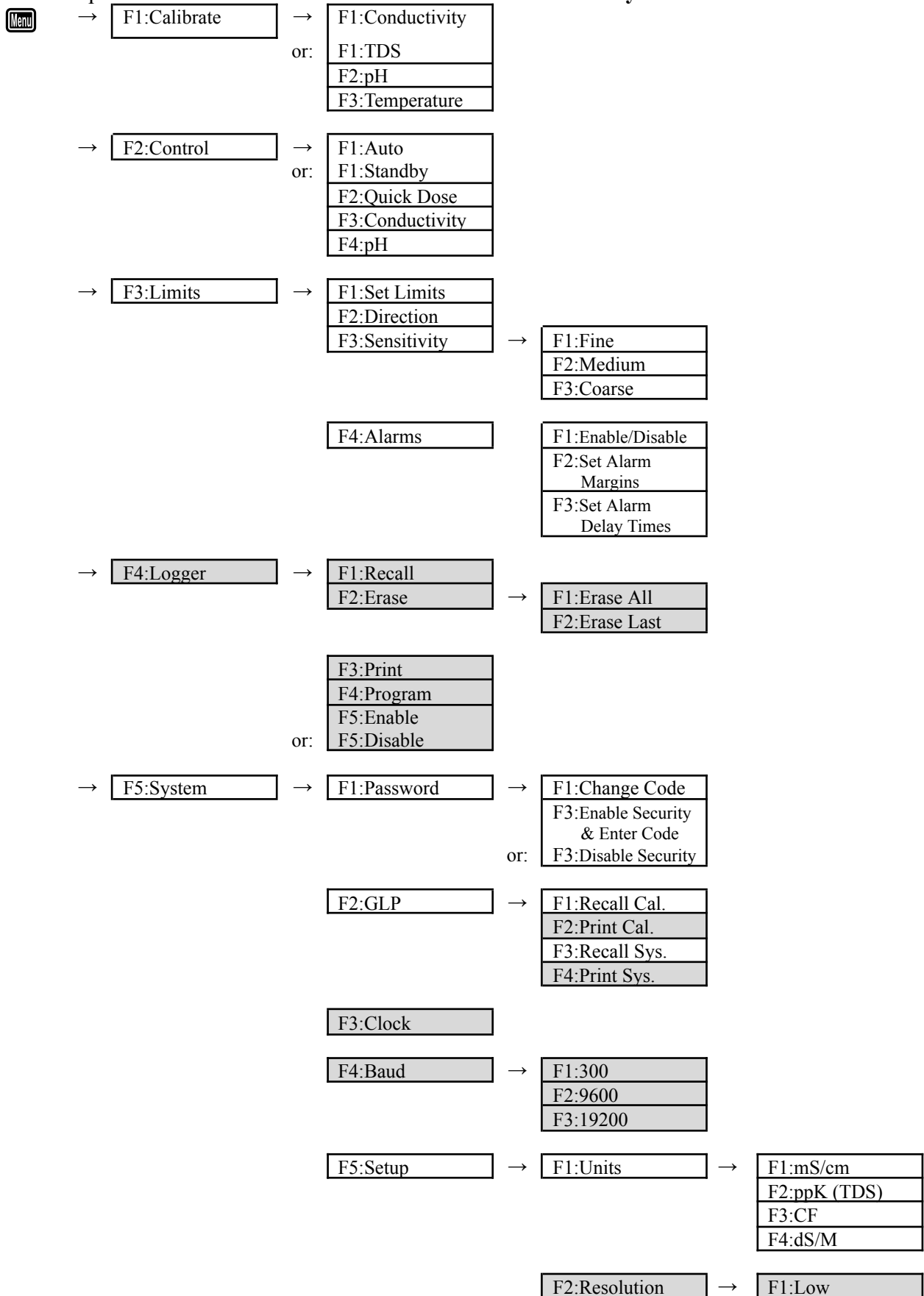



		F2:High
F3:ShutOFF		
F4:Buffer	→	Select pH buffers
F5:Initialise	→	F1:Calibration only F2:Full System

Functions in shaded cells are available when the Plus-Pack option is fitted.



2. Limits Set-up



The limits must be set to the required values before attempting to use the **hydroCHEM** for automatic control.

2.1 Setting the Control Limits

1. Select the Limits menu ( → **F3:Limits**).
2. Select **F1:Set limits** from the menu. The current Conductivity limit is displayed. For example...



```
Enter Conductivity Limit : 2.0 mS/cm
```

Use the  and  keys to set the Conductivity limit. The allowable range is 0.0 to 9.9 mS/cm.

Press  to save the new value, or press  to quit without saving the changes.

3. The current pH limit is now displayed. For example...

```
Enter pH Limit : 6.5pH
```

Use the  and  keys to set the pH limit. The allowable range is 0.0 to 14.0 pH.

Press  to save the new value, or press  to quit without saving the changes.

4. The control limits are now set to the required values.

2.2 Control Direction

The **hydroCHEM** is factory set to add nutrient when the Conductivity reading is lower than the limit, and to add acid when the pH reading is higher than the limit. To change these settings...

1. Select the Limits menu ( → **F3:Limits**).
2. Select **F2:Direction** from the menu. The following screen will now be displayed...

```
Select Conductivity Direction  
→F1:Add when LOW      F2:Add when HIGH
```

The arrow indicates the current selection.

Press  to add nutrient when the Conductivity reading is lower than the limit.

Press  to add freshwater when the Conductivity reading is higher than the limit.

3. The **hydroCHEM** confirms the selection and then goes on to select the pH Direction...

```
Select pH Direction  
F1:Add when LOW      →F2:Add when HIGH
```

The arrow indicates the current selection.

Press  to add alkali (eg. Soda Ash) when the pH reading is lower than the limit.

Press  to add acid when the pH reading is higher than the limit.



4. The **hydroCHEM** confirms the selection before going back to the Limits menu.

2.3 Control Sensitivity

To stop the pumps being rapidly switched on and off, the **hydroCHEM** operates the pumps for a preset band around the control limit. Examples to illustrate this are given at the end of this section. To select the Control Sensitivity...

1. Select the Limits menu ( → **F3:Limits**).
2. Select **F3:Sensitivity** from the menu. The following screen will now be displayed...

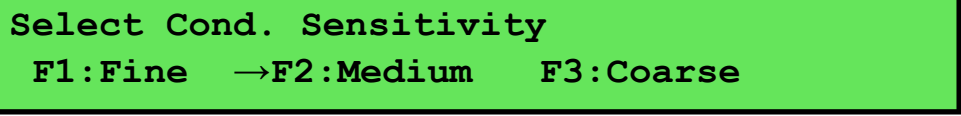

Select Cond. Sensitivity
F1:Fine →F2:Medium F3:Coarse

The arrow indicates the current selection.

Press  to select Fine Sensitivity. The control band will be 0.1 mS/cm.

Press  to select Medium Sensitivity. The control band will be 0.2 mS/cm.

Press  to select Coarse Sensitivity. The control band will be 0.3 mS/cm.

3. The **hydroCHEM** confirms the selection and then goes on to select the pH Sensitivity...



Select pH Sensitivity
F1:Fine →F2:Medium F3:Coarse

The arrow indicates the current selection.

Press  to select Fine Sensitivity. The control band will be 0.1 pH.

Press  to select Medium Sensitivity. The control band will be 0.2 pH.

Press  to select Coarse Sensitivity. The control band will be 0.3 pH.

4. The **hydroCHEM** confirms the selection before going back to the Limits menu.

2.4 Control Limit Set-up examples

- The following diagram illustrates the Conductivity control action of the **hydroCHEM**, when the limit is set to 2.0 mS/cm, adding when low, with medium control sensitivity (0.2 mS/cm).

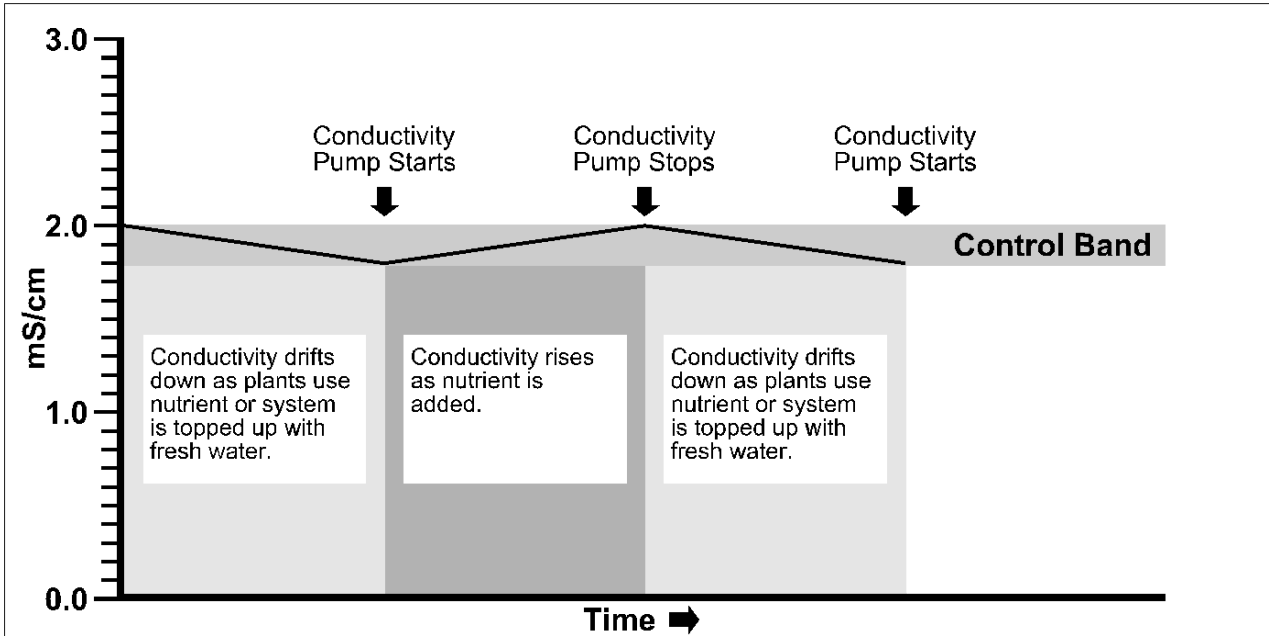

- The following diagram illustrates the pH control action of the **hydroCHEM**, when the limit is set to 6.5 pH, adding when high, with fine control sensitivity (0.1pH).

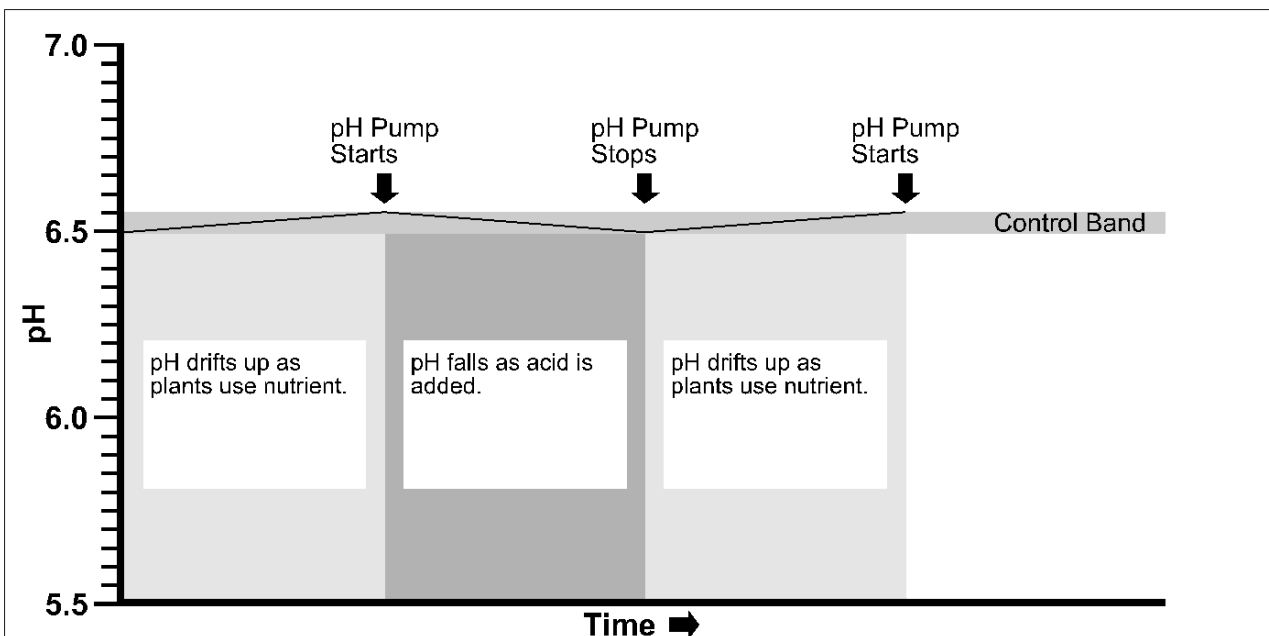

2.5 Alarms



An alarm function is available to provide an indication that Conductivity and/or pH have been outside the limits by a set margin for a set period of time. This alarm is useful, as it can provide forewarning of a potential system problems, such as empty tanks or faulty sensors.

To use the alarm function, the alarm margin on either side of the limit must first be set. A delay time must then be set so that the alarm is not activated immediately. This allows for momentary spikes outside the alarm margin. Once the alarm margin and delay times have been set, the alarm function must be enabled. The following sections detail these procedures, and examples are provided at the end.



2.5.1 Setting the Alarm Margins



1. Select the Alarms menu ( → **F3:Limits** → **F4:Alarms**).
2. Select **F2:Set Alarm Margins** from the menu. The current Conductivity alarm margin is displayed. For example...

```
Enter COND Alarm Margin : 0.30mS/cm
Low Alarm at 1.50, High Alarm 2.30mS/cm
```

Use the  and  keys to set the Conductivity alarm margin. The minimum alarm margin is dependant on the Control Sensitivity setting, which can be 0.10 mS/cm (Fine), 0.20 mS/cm (Medium) or 0.30 mS/cm (Coarse). The maximum alarm margin is 2.00 mS/cm.



The Low and High Alarm values displayed are calculated using the current Conductivity Limit and Sensitivity settings.

As the  or  key is released, the display is updated with re-calculated Low and High Alarm values.



Press  to save the new value, or press  to quit without saving the changes.

3. The current pH alarm margin is now displayed. For example...

```
Enter pH Alarm Margin : 0.3pH
Low Alarm at 6.2pH, High Alarm 7.0pH
```

Use the  and  keys to set the pH alarm margin. The minimum alarm margin is dependant on the Control Sensitivity setting, which can be 0.1 pH (Fine), 0.2 pH (Medium) or 0.3 pH (Coarse). The maximum alarm margin is 3.0 pH.

The Low and High Alarm values displayed are calculated using the current pH Limit and Sensitivity settings.

As the  or  key is released, the display is updated with re-calculated Low and High Alarm values.



Press  to save the new value, or press  to quit without saving the changes.

4. The alarm margins are now set to the required values.

2.5.2 Setting the Alarm Delay Times

1. Select the Alarms menu ( → **F3:Limits** → **F4:Alarms**).
2. Select **F3:Set Alarm Delay Times** from the menu. The current Conductivity alarm delay time is displayed. For example...



Enter COND Alarm Delay Time : 10mins

Use the  and  keys to set the Conductivity alarm delay time. The allowable range is 5 to 60 minutes.

Press  to save the new value, or press  to quit without saving the changes.

3. The current pH alarm delay time is now displayed. For example...

Cond Alarm Delay Time : 10mins
Enter pH Alarm Delay Time : 10mins

Use the  and  keys to set the pH alarm delay time. The allowable range is 5 to 60 minutes.

Press  to save the new value, or press  to quit without saving the changes.

4. The alarm delay times are now set to the required values.

2.5.3 Enabling and Disabling the Alarm Function

To enable the alarm function...

1. Set the required Alarm Margins and Alarm Delay Times, as per sections 2.5.1 and 2.5.2.
2. Select the Alarms menu ( → **F3:Limits** → **F4:Alarms**).
3. Select **F1:Enable** from the menu.

The alarm function is now enabled. The alarm system is only functional when the **hydroCHEM** is in Automatic Control mode (see section 3.3).



To disable the alarm function...

1. Select the Alarms menu ( → **F3:Limits** → **F4:Alarms**).
2. Select **F1:Disable** from the menu.
3. The alarm function is now disabled.



2.5.4 Procedure in event of Alarm function being tripped

When the alarm function has been tripped, the units for the relevant parameter flash and the **hydroCHEM** beeps.

To check what has caused the alarm, press the  key. To re-set the alarm function, press the  key.

Automatic control will continue even while the alarm is activated, as the hydroCHEM will attempt to correct the alarm condition.

The condition that caused the alarm function to trip must be rectified to avoid it being tripped again. This may involve one or more of the following...

- Check and re-calibrate the Conductivity and/or pH sensors to ensure the reading is actually correct.
- Extend the ON time if the pump rate is not high enough to keep up with chemical demand for the current ON time.
- Place the chemical addition point as close as possible to the take-up for the sample chamber.
- The Conductivity and/or pH levels in the system may have changed too rapidly for the dosing pumps to keep up. If this was due to a singular event (eg. top up tank with fresh water), then the alarm may be ignored. If this was due to normal operation and none of the above suggestions have worked, larger capacity dosing pumps may be required. Contact your distributor or the TPS factory.

2.5.5 External Alarm Siren

An external alarm siren is available for alarm indication (part no. 130101). This may be particularly useful if the **hydroCHEM** is mounted inside a shed or pump room.

The external alarm siren simply plugs into the **Optional In / Out** socket.

2.5.6 Alarm Set-up Examples

- The following diagram illustrates the Conductivity alarm function of the **hydroCHEM**, with an alarm margin of 0.3mS/cm and an alarm delay time of 5 minutes. The limit is set to 2.0mS/cm, adding when low and with medium control sensitivity (0.2 mS/cm).

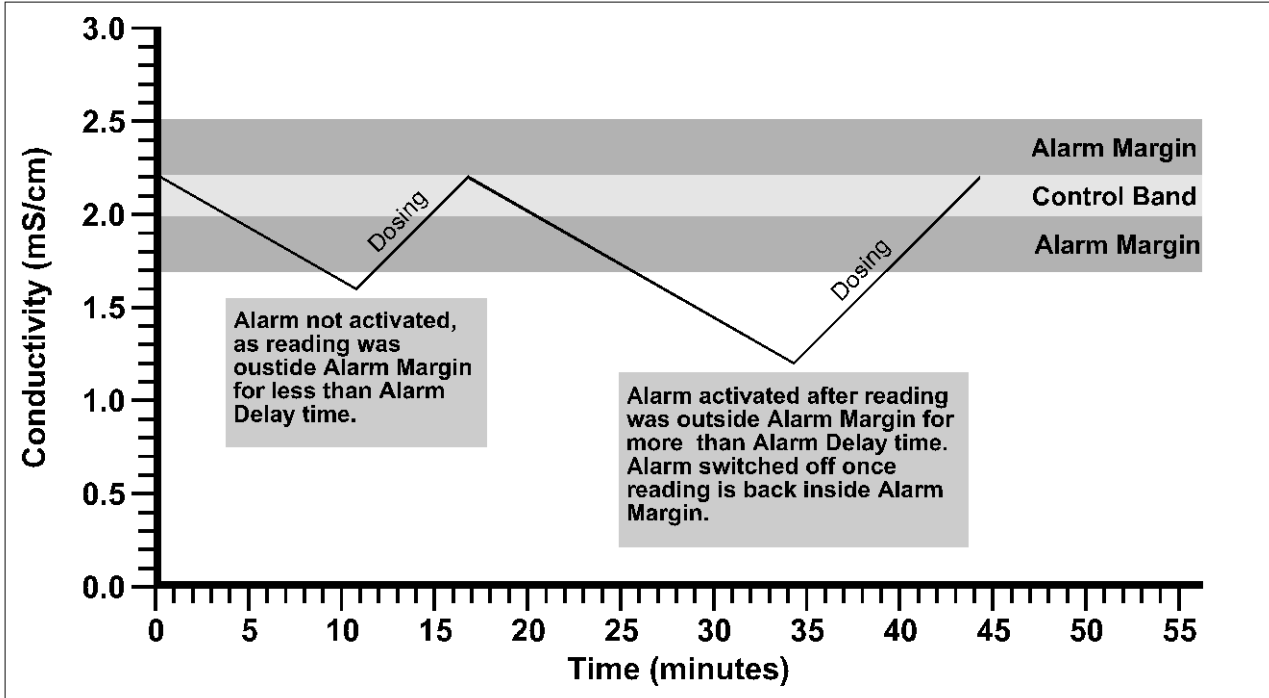

- The following diagram illustrates the pH control action of the **hydroCHEM**, with an alarm margin of 0.3pH and an alarm delay time of 5 minutes. The limit is set to 6.5 pH, adding when high and with medium control sensitivity (0.2pH).

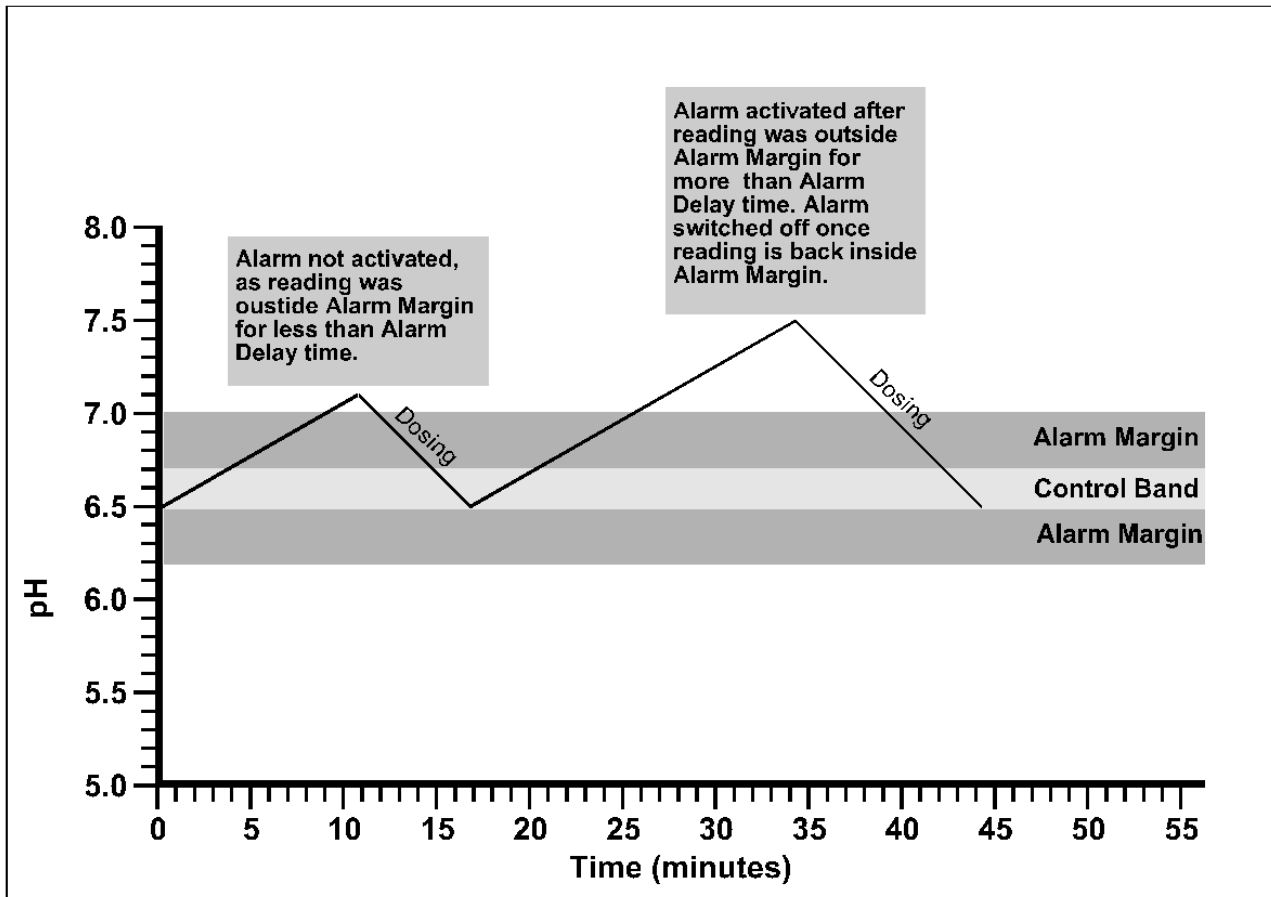

3. Control Set-up

The **hydroCHEM** control function must be set up correctly before attempting to use the **hydroCHEM** for automatic control. Setting up the control function involves setting the ON and OFF times for each pump. Conductivity and pH ON and OFF times can be set independently, to allow for the different effects these have on the total system.

The ON time is the maximum amount of time the pump will operate continuously. For example, if the Conductivity ON time is set to 5 minutes, the Conductivity pump will add A&B Nutrient for a maximum of 5 minutes and then wait for the OFF time. Of course, if the Conductivity gets back within the limit earlier, the pump will stop before the end of the 5 minutes.

The OFF time is the waiting time between ON cycles. Even if the Conductivity or pH go outside their normal limits during the OFF time, the **hydroCHEM** will not activate the relevant pump until the entire OFF time has elapsed.

In the examples shown in sections 3.1 and 3.2, the ON times are both set to 5 minutes and the OFF times are set to 10 minutes. This means that the unit will dose for a maximum of 5 minutes, then wait for 10 minutes. These ON and OFF times cycle repetitively. At all times, the Conductivity and pH pumps will only operate when the readings are outside the limits.



Correct use of an ON and OFF cycle will avoid overdosing problems.

3.1 Setting up the Conductivity control function

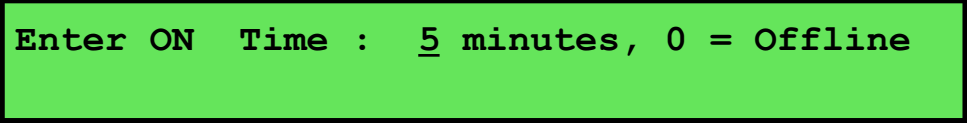
1. Select the Control menu ( → **F2:Control**).
2. Select **F3:Conductivity** from the menu. The following screen is now displayed...



```
Enter ON Time : 5 minutes, 0 = Offline
```



Use the  and  keys to enter the ON time for the Conductivity pump (up to 30 minutes). Enter Zero to take the Conductivity pump off line.

Press  to save the new value, or press  to quit without saving the changes.

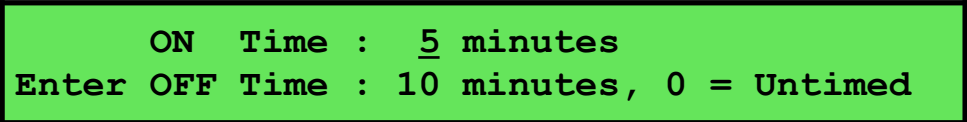
3. The **hydroCHEM** then goes on to the OFF time entry...



```
ON Time : 5 minutes
Enter OFF Time : 10 minutes, 0 = Untimed
```

Use the  and  keys to enter the OFF time for the Conductivity pump (up to 30 minutes). Enter Zero to make the Conductivity pump operate on demand whenever the reading is outside the limit.



Press  to save the new value, or press  to quit without saving the changes.

4. The Conductivity control function is now set up and the **hydroCHEM** returns to the Control menu.

3.2 Setting up the pH control function

5. Select the Control menu ( → **F2:Control**).
6. Select **F4:pH** from the menu. The following screen is now displayed...



Enter ON Time : 5 minutes, 0 = Offline

Use the  and  keys to enter the ON time for the pH pump (up to 30 minutes).
Enter Zero to take the pH pump off line.

Press  to save the new value, or press  to quit without saving the changes.

7. The **hydroCHEM** then goes on to the OFF time entry...

ON Time : 5 minutes
Enter OFF Time : 10 minutes, 0 = Untimed

Use the  and  keys enter the OFF time for the pH pump (up to 30 minutes).
Enter Zero to make the pH pump operate on demand whenever the reading is outside the limit.

Press  to save the new value, or press  to quit without saving the changes.

8. The pH control function is now set up and the **hydroCHEM** returns to the Control menu.

3.3 Selecting Automatic Control or Standby Modes

To enable the **hydroCHEM** to automatically control Conductivity and pH, Automatic mode must be selected. The pumps will operate according to the ON and OFF times discussed in sections 3.1 and 3.2, when Conductivity and/or pH readings are outside the limits.

To disable automatic control (eg. when calibrating the unit), Standby mode must be selected.

To switch between Automatic and Standby modes...

1. Select the Control menu ( → **F2:Control**).
2. When the **hydroCHEM** is in Standby mode, select **F1:Auto** to switch to Automatic mode.
When the **hydroCHEM** is in Automatic mode, select **F1:Standby** to switch to Standby mode.

NOTE

Automatic control is disabled when there is no flow in the sample chamber. The Conductivity, pH and Temperature data is replaced by "**NoFlo**" when there is no flow.



4. Quick-Dose Function

The Quick-Dose function enables the operator to quickly add a measured dose of Nutrient A & B and/or pH adjustor, regardless of the Limits or Control set-up. This feature is particularly useful to prime the pumps, or to trim up a fresh tank of water before commencing normal automatic control.

To begin a Quick-Dose cycle...



1. Select the Control menu ( → **F2:Control**).
2. Select **F2:Quick Dose** from the menu.
3. The **hydroCHEM** now prompts you to enter the dosing time for the Nutrient A & B pumps. The default time is 5 minutes....

Enter Cond. Quick Dose Time : 5 mins

Use the  and  keys to set the time for which the Nutrient A & B pumps are to operate (from 0 to 10 minutes).

4. The **hydroCHEM** now prompts you to enter the dosing time for the pH pump. The default time is 5 minutes. The Nutrient A & B pump time remains on the display, for your reference...

Cond. Quick Dose Time : 5 mins
Enter pH Quick Dose Time : 5 mins

Use the  and  keys to set the time for which the pH pump is to operate (from 0 to 10 minutes).

5. The **hydroCHEM** now returns to the Control menu. To start the Quick-Dose cycle, the unit must be returned to normal display mode. The display will count down the dosing time individually for each pump.

NOTES

- To stop the Quick-Dose cycle, press the  key. It is then necessary to repeat this programming procedure to re-enable the function.
- The Quick-Dose function is enabled even when there is no flow through the sample chamber. Before using this function, ensure that addition of Nutrient A, Nutrient B and/or pH adjustor will not over-dose your system.
- The pump load is shown as a percentage (of full load) during quick dose. This can be used as a method of checking the condition of the pumps and tubes. If the load exceeds 100% the pump/s will be turned off and “**PumpERROR**” will be displayed. If this occurs, check/clean tubing. Try quick dose again and if the error re-occurs the pump has a fault and will require service.

5. Flow Sensing

5.1 hydroCHEM-DS Flow Sensing

The **hydroCHEM-DS** uses the Conductivity reading to determine if there is an adequate flow of nutrient solution through the sample chamber. See section 10.2 for details on how to adjust the sample flow rate.

This feature has been provided so that the **hydroCHEM-DS** can be switched on at all times, and automatic dosing only occurs when the pump which feeds the sample chamber is operating. No separate flow sensing or timer cycle is therefore needed for the **hydroCHEM-DS** to dose at the required times.

The following conditions occur when there is little or no flow of nutrient through the sample chamber...

- The data is replaced by "**NoFlo**" on the **hydroCHEM** display.
- Automatic control is disabled. The Nutrient and pH pumps will not operate until adequate flow is restored.
- Quick-Dose is still operational. Ensure that the quick dose cycle will not cause the system to be over-dosed.
- The Conductivity, pH and Temperature being sent to the RS232 port is replaced with spaces (see section 16.6).

5.1.1 Flow Sensing Troubleshooting

Symptom	Possible Causes	Suggested Remedy
"NoFlo" message does not appear, even when the Conductivity sensor is dry and in air	<ol style="list-style-type: none"> 1. Sensor has a build-up of salts or algae between wires. 2. Sensor is faulty. 	<p>Clean probe as per section 25.2.2.</p> <p>Return sensor to factory for repair or replacement.</p>
"NoFlo" message appears even when the Conductivity sensor is in solution.	<ol style="list-style-type: none"> 1. Conductivity of solution is below 500 $\mu\text{S}/\text{cm}$ (245 ppm TDS). 2. Sensor is faulty. 	<p>The flow sensing function only operates if the Conductivity is above 500 $\mu\text{S}/\text{cm}$ (245 ppm TDS).</p> <p>An optional pump detector is available to solve this problem. Please contact the factory or your distributor.</p> <p>Return sensor to factory for repair or replacement.</p>

5.2 hydroCHEM Flow Sensing

The **hydroCHEM** is supplied with a pump sensor. Plug the pump sensor into the “**Optional In/Out**” socket on the **hydroCHEM**.

This sensor detects whether or not the feeding or recirculating pump is operating. The ideal location for mounting pump sensor is nearest the pump motor, as per the diagram below. After mounting the sensor, switch the pump on, and check that the "NoFlo" indication is replaced by the Conductivity/TDS, pH and Temperature data on the **hydroCHEM** display.

This feature has been provided so that the **hydroCHEM** can be switched on at all times, and automatic dosing only occurs when the feeding or recirculating pump is on. No separate flow sensing or timer cycle is therefore needed for the **hydroCHEM** to dose at the required times.

The following conditions occur when the pump sensor detects that the pump is not operating...

- The data is replaced by "NoFlo" on the **hydroCHEM** display.
- Automatic control is disabled. The Nutrient and pH control outputs will not be activated unless the feeding or recirculating pump is operating.
- Quick-Dose is still operational. Ensure that the quick dose cycle will not cause the system to be over-dosed.
- The Conductivity/TDS, pH and Temperature data being sent to the RS232 port is replaced with spaces (see section 16.6).

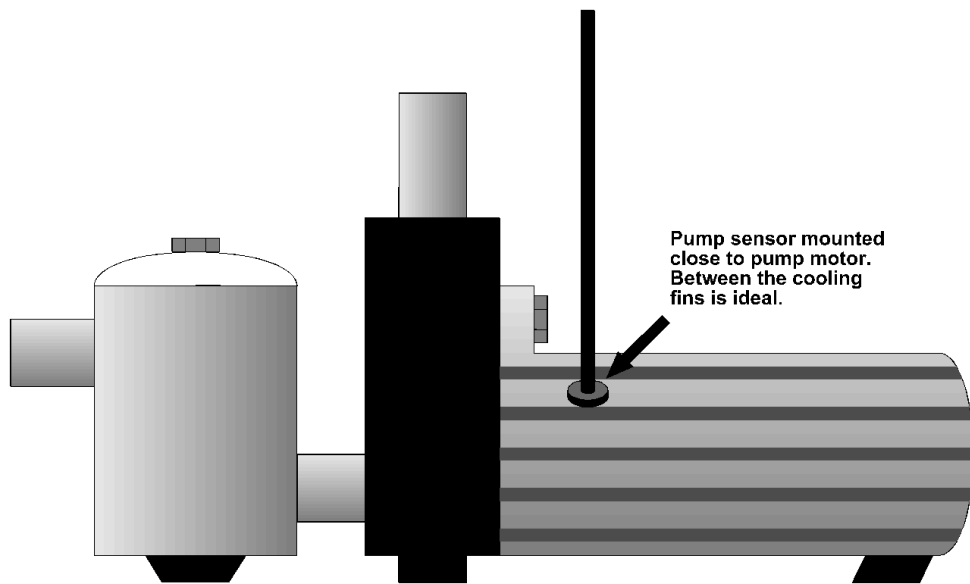

5.2.1 Flow Sensing Troubleshooting

Symptom	Possible Causes	Suggested Remedy
"NoFlo" message does not appear, even when the feeding or recirculating pump is OFF.	Pump Sensor is faulty.	Return sensor to factory for repair or replacement.
"NoFlo" message appears even when the feeding or recirculating pump is operating.	<ol style="list-style-type: none"> 1. Pump Sensor not mounted in optimum position on pump housing. 2. Pump Sensor is faulty. 	Try mounting the sensor in alternative positions on the pump. The best position is close to the pump motor.



		Return sensor to factory for repair or replacement.
--	--	---

6. Temperature Calibration

The temperature readout must be calibrated or manually set before attempting Conductivity or pH calibration. The decimal point is replaced by a “ * ” if the reading is not calibrated.

6.1 Temperature Calibration Procedure



1. Ensure that the **hydroCHEM** is in Standby mode (see section 3.3).
2. Plug the Conductivity/Temperature sensor into the **Cond/Temp** socket.
3. Place the sensor into a beaker of room temperature water alongside a good quality mercury thermometer. Stir the sensor and the thermometer gently to ensure an even temperature throughout the beaker.
4. Select Temperature Calibration ( → **F1:Calibrate** → **F3:Temperature**).

The Temperature Calibration screen is now displayed. For example...

```
Enter Actual Temperature : 25.0      24*0°C
Temperature Calibration      Menu Quits
```

The cursor is at the new temperature value you will be setting.

The current reading from the Temperature sensor is displayed on the far right of the top line.

5. When the reading from the Temperature sensor has stabilised, use the  and  keys to enter the same temperature as measured by the mercury thermometer.
6. Press the  key to calibrate the temperature readout.

Alternatively, press the  key to abort temperature calibration.

6.2 Temperature Calibration Notes

1. The **hydroCHEM** has an allowable Offset range of -10.0 to $+10.0$ °C. If calibration fails due to the Offset being outside these limits, then please consult the Troubleshooting guide (section 24.4) for possible remedies.
2. Temperature calibration information is retained in memory when the **hydroCHEM** is switched off, even when the power supply is removed. This information can be recalled later using the GLP function (see section 14).
3. Temperature does not need to be re-calibrated unless the Conductivity/Temperature sensor is replaced or the meter is initialised.

6.3 Temperature Calibration Messages

1. If a temperature calibration has been successfully performed, the **hydroCHEM** will display the following message and the offset of the sensor. For example...

```
Temperature Calibration OK
0.1°C Offset
```

2. If a temperature calibration has failed, the **hydroCHEM** will display the following message and the failed offset value of the sensor. For example...

```
Temperature Calibration Failed
11.0°C Offset
```

7. Conductivity Calibration

Before attempting a Conductivity calibration ensure that Temperature has been correctly calibrated (see section 6). A “ * ” in the Temperature readout in place of the decimal point indicates that Temperature is NOT calibrated.

See section 18 for details on how to select the Conductivity readout units that you wish to use.



7.1 Conductivity Calibration Procedure

1. Ensure that the **hydroCHEM** is in Standby mode (see section 3.3).
2. Plug the Conductivity sensor into the **Cond/Temp** socket.
3. Rinse the sensor in distilled water. Shake off as much water as possible. Blot the outside of the sensor dry.

Zero Calibration

4. Let the sensor dry in air.
5. Select Conductivity Calibration ( → **F1:Calibrate** → **F1:Conductivity**).
6. The **hydroCHEM** will recognise the low Conductivity signal and attempt a Zero calibration. For example...

0*1mS/cm 25.0°c
 Press Enter to Calibrate to Zero

7. When the reading has stabilised at or near zero, press  to calibrate or  to quit. The "*" will not be removed after a zero calibration.

Standard Calibration

8. Place the Conductivity sensor into a sample of 2.76 S/cm or 1.41 S/cm standard so that it is immersed at least to the first vent hole, as per the diagram below.

DO NOT place the sensor directly into the bottle of standard. Discard the used sample of standard after use.

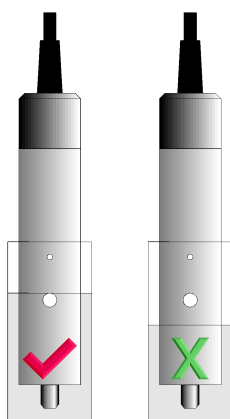

9. Select Conductivity Calibration ( → **F1:Calibrate** → **F1:Conductivity**). The calibration screen will be displayed, with the Conductivity standard to be used. For example...

2*5mS/cm 25.0°c
 Press Enter to Calibrate to 2.76mS/cm



10. When the reading has stabilised, press  to calibrate. The "*" will now be replaced by a decimal point if calibration was successful.
11. The **hydroCHEM** is now calibrated for Conductivity and is ready for use in this mode.



7.2 Conductivity Calibration Notes

1. When a Zero calibration fails, span calibration is lost. Both a Zero and a Span calibration **MUST** be done once the problem has been remedied.
2. The allowable zero range for the Conductivity sensor is 0 to 0.2 mS/cm. If a zero calibration fails, please consult the Troubleshooting guide (section 24.2).
3. The allowable span range is 75% to 133%. This range is ample to allow for correctly functioning Conductivity sensors. If calibration fails due to the k factor being outside these limits, then please consult the Troubleshooting guide (section 24.2) for possible remedies.
4. A Zero calibration should be performed at least monthly.
5. A Standard calibration should be performed at least weekly. Of course, more frequent calibration will result in greater confidence in results.
6. Conductivity and TDS calibration data are stored in a single area in memory. Ensure that the **hydroCHEM** has been correctly calibrated for the mode in which it will be used. The **hydroCHEM** may require re-calibration when alternating between Conductivity and TDS modes.
7. All calibration information is retained in memory when the **hydroCHEM** is switched off, even when the power supply is unplugged. This information can be recalled or printed later using the GLP function (see section 14).
8. The **hydroCHEM** displays the value of the standard to which it will attempt to calibrate. Ensure that the standard value displayed corresponds to the standard that you are using.

7.3 Conductivity Calibration Messages

1. If a Zero Calibration has been successfully performed, the **hydroCHEM** will display the following message and the Zero value of the sensor. For example...

```
Zero Calibration OK, Zero=0.1mS/cm
```

2. If a Standard Calibration has been successfully performed, the **hydroCHEM** will display the following message and the span value of the sensor. For example...

```
2.76mS/cm Calibration OK, Span=100.1%
```

3. If a Standard Calibration has failed, the **hydroCHEM** will display the following message and the failed span value of the sensor. For example...

```
2.76mS/cm Calibration Failed, Span=50.0%
```

8. TDS Calibration

Before attempting a TDS calibration ensure that Temperature has been correctly calibrated (see section 6). A “ * ” in the Temperature readout in place of the decimal point indicates that Temperature is NOT calibrated.

See section 18 for details on how to select TDS readout mode.



8.1 TDS Calibration Procedure

1. Ensure that the **hydroCHEM** is in Standby mode (see section 3.3).
2. Plug the Conductivity sensor into the **Cond/Temp** socket.
3. Rinse the sensor in distilled water. Shake off as much water as possible. Blot the outside of the sensor dry.

Zero Calibration

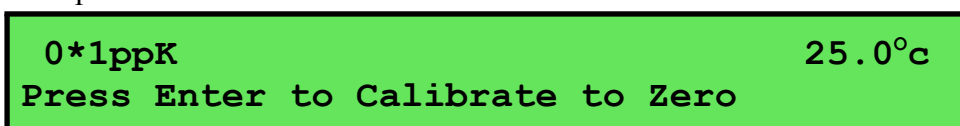
4. Let the sensor dry in air.
5. Select TDS Calibration ( → **F1:Calibrate** → **F1:TDS**).
6. The **hydroCHEM** will recognise the low TDS signal and attempt a Zero calibration. For example...





7. When the reading has stabilised at or near zero, press  to calibrate or  to quit. The "*" will not be removed after a zero calibration.

Standard Calibration

8. Place the Conductivity sensor into a sample of 2.0 ppK standard so that it is immersed at least to the first vent hole, as per the diagram below.

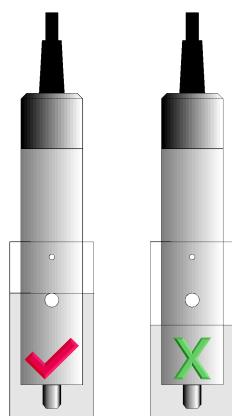
DO NOT place the sensor directly into the bottle of standard. Discard the used sample of standard after use.



9. Select TDS Calibration ( → **F1:Calibrate** → **F1:TDS**). The calibration screen will be displayed, with the TDS standard to be used. For example...

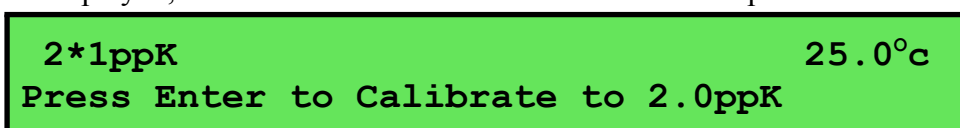



10. When the reading has stabilised, press  to calibrate. The "*" will now be replaced by a decimal point if calibration was successful.
11. The **hydroCHEM** is now calibrated for TDS and is ready for use in this mode.



8.2 TDS Calibration Notes

1. When a Zero calibration fails, span calibration is lost. Both a Zero and a Span calibration **MUST** be done once the problem has been remedied.
2. The allowable zero range for the Conductivity sensor is 0 to 0.1 ppK. If a zero calibration fails, please consult the troubleshooting guide (section 24.2).
3. The allowable span range is 75% to 133%. This range is ample to allow for correctly functioning Conductivity sensors. If calibration fails due to the k factor being outside these limits, then please consult the Troubleshooting guide (section 24.2) for possible remedies.
4. A Zero calibration should be performed at least monthly.
5. A Standard calibration should be performed at least weekly. Of course, more frequent calibration will result in greater confidence in results.
6. TDS and Conductivity calibration data are stored in a single area in memory. Ensure that the **hydroCHEM** has been correctly calibrated for the mode in which it will be used. The **hydroCHEM** may require re-calibration when alternating between Conductivity and TDS modes.
7. All calibration information is retained in memory when the **hydroCHEM** is switched off, even when the power supply is unplugged. This information can be recalled or printed later using the GLP function (see section 14).
8. The **hydroCHEM** displays the value of the standard to which it will attempt to calibrate. Ensure that the standard value displayed corresponds to the standard that you are using.

8.3 TDS Calibration Messages

4. If a Zero Calibration has been successfully performed, the **hydroCHEM** will display the following message and the Zero value of the sensor. For example...

```
Zero Calibration OK, Zero=0.1ppK
```

5. If a Standard Calibration has been successfully performed, the **hydroCHEM** will display the following message and the span value of the sensor. For example...

```
2.0ppK Calibration OK, Span=100.1%
```

6. If a Standard Calibration has failed, the **hydroCHEM** will display the following message and the failed span value of the sensor. For example...

```
2.0ppK Calibration Failed, Span=50.0%
```



9. pH Calibration

Before attempting a pH calibration ensure that Temperature has been correctly calibrated (see section 6). A “ * ” in the Temperature readout in place of the decimal point indicates that Temperature is NOT calibrated.

9.1 pH Calibration Procedure

1. Ensure that the **hydroCHEM** is in Standby mode (see section 3.3).
2. Plug the pH sensor into the **pH** socket and the Conductivity/Temperature sensor into the **Cond/Temp** socket. Switch the meter on.
3. Remove the wetting cap from the pH sensor. Rinse the sensors in distilled water. Shake off as much water as possible. Blot the outside of the sensors dry.
4. Ensure that the primary and secondary buffers to be used have been correctly selected for automatic buffer recognition. See section 21.
5. Place the pH sensor into a small sample of primary buffer (pH7.00 or 6.86). Ensure that the entire bulb and reference junction are immersed, as per the diagram below. Place the Conductivity/Temperature sensor into a separate beaker of liquid that is at the same temperature as the buffer (this is required for correct Temperature compensation).

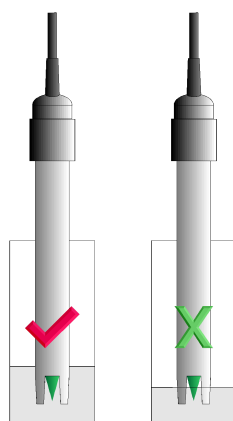
DO NOT place the electrodes directly into the buffer bottle.



6. Select pH Calibration ( → **F1:Calibrate** → **F2:pH**). The display should now look something like this...

```

7*1pH      Buffer=  7.0      25.0°C
Press Enter to Calibrate, or Menu Exits
  
```

The current pH reading is shown on the left. Note the “ * ”, indicating that pH is currently not calibrated. Wait for this reading to stabilise before attempting to calibrate the **hydroCHEM**.

The buffer that the **hydroCHEM** has attempted to recognise is also displayed with the correct value at the current temperature.

Press  to calibrate to the displayed buffer or  to quit without re-calibrating.

If a 1 point calibration has been performed, the "*" will not be removed until a full 2 point calibration has been performed.

7. Rinse the pH sensor in distilled water and blot dry.

- Place the pH sensor into a small sample of secondary buffer (pH4.01, 9.18 or 10.01). Ensure that the entire bulb and reference junction are immersed, as per the diagram in step 5, above. Place the Conductivity/Temperature sensor into a separate beaker of liquid that is at the same temperature as the buffer (this is required for correct Temperature compensation).

DO NOT place the electrodes directly into the buffer bottle.

pH9.18 and pH10.01 buffers are unstable once the bottles have been opened. Discard immediately after use.

- Select pH Calibration ( → **F1:Calibrate** → **F2:pH**). The display should now look something like this...

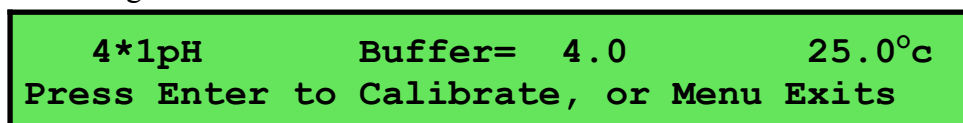

```
4*1pH          Buffer=  4.0          25.0°C
Press Enter to Calibrate, or Menu Exits
```

Note that the **hydroCHEM** has automatically recognised the second buffer.

Wait for the displayed reading to stabilise before attempting to calibrate the **hydroCHEM**.

Press  to calibrate to the displayed buffer or  to quit without re-calibrating.

- The **hydroCHEM** is now calibrated and is ready for use. Discard the used samples of buffer.

9.2 pH Calibration Notes

- The **hydroCHEM** has an allowable Asymmetry range of -1.00 to $+1.00$ pH. The allowable Slope range is 85.0 to 105.0 %. If calibration fails due to either the Asymmetry or the Slope being outside these limits, please consult the Troubleshooting guide (section 24.3) for possible remedies.
- A 1-point calibration should be performed at least weekly.
- A full 2-point calibration should be performed at least monthly. Of course, more frequent calibration will result in greater confidence in results.
- All calibration information is retained in memory when the **hydroCHEM** is switched off, even when the power supply is removed. This information can be recalled or printed later using the GLP function (see section 14).

9.3 pH Calibration Messages

1. If a 1-point calibration has been successfully performed, the **hydroCHEM** will display the following message and the asymmetry of the electrode. Note that the slope value from the last calibration is also shown. For example...

```
Asymmetry Calibration Successful
+0.10pH Asym          100.0% Slope
```

2. If a 1-point calibration has failed, the **hydroCHEM** will display the following message, and the failed asymmetry value of the electrode. For example...

```
Calibrate Failed, +1.1 pH Asymmetry
Repeat Cal. or Initialise Calibration
```

3. If a 2-point calibration has been successfully performed, the **hydroCHEM** will display the following message, and the asymmetry and slope of the electrode. For example...

```
Slope & Asymmetry Calibration Successful
+0.10pH Asym          99.0% Slope
```

4. If a 2-point calibration has failed, the **hydroCHEM** will display the following message, and the failed slope value of the electrode. For example...

```
Calibrate Failed, 80% Slope
Repeat Cal. or Initialise Calibration
```

10. Setting up the Sample Chamber

This section is applicable for the **hydroCHEM** Dosing System, which has the flow-through sample chamber installed on a mounting board with the **hydroCHEM** unit.

10.1 Connecting the tubing

The **hydroCHEM** Dosing System is supplied with 10 metres of 13 mm black polyethylene tubing. The input tubing should be connected to a take-off on the output side of the crop feeding pump. Alternatively, if a separate mixing pump is being used in the main tank, it can be connected on the output side of this. The sample chamber is not designed to take the full pressure of the entire flow of nutrient to the crop. It is designed to monitor just a small sample.

The normal output fitting is on the right hand side of the sample chamber. This should be run back to the main tank downwards in as straight a line as possible. Do not coil the output tubing.

The sample/drain tap is provided for two reasons. Firstly, it allows the operator to obtain a sample of nutrient from the flow chamber. This may be required if the nutrient is to be checked by another instrument for example. The second use of the sample/drain tap is to completely drain the sample chamber. This makes the process of cleaning easier, as it avoids a splash of nutrient when the lid of the sample chamber is removed. A tube may be fitted to this if required, although it is not essential. Run any tube back to the main tank downwards in as straight a line as possible. Do not coil the tubing.

The emergency overflow fitting is very important. It has been fitted to provide a vent, should the normal overflow tubing become blocked. Fit as short a run of tubing to this fitting as possible. Run the tubing back to the main tank downwards in as straight a line as possible. Do not coil the output tubing.

The diagram below shows a sample chamber with all tubing fitted.

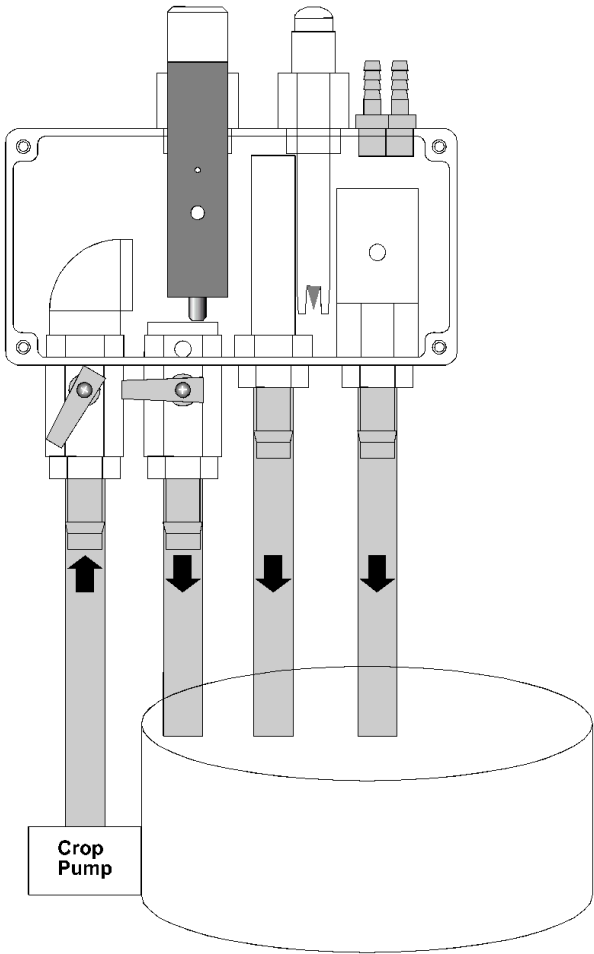



10.2 Adjusting the Flow Rate

The correct flow rate is achieved when the nutrient flows over the top of the normal overflow fitting. The flow should not completely fill the sample chamber, as this will cause pressure which may make the sample chamber leak. If the flow is not sufficient to cause the nutrient to flow over the top of the normal overflow fitting, then Conductivity readings will be too low or the **hydroCHEM** may even register a No Flow condition.

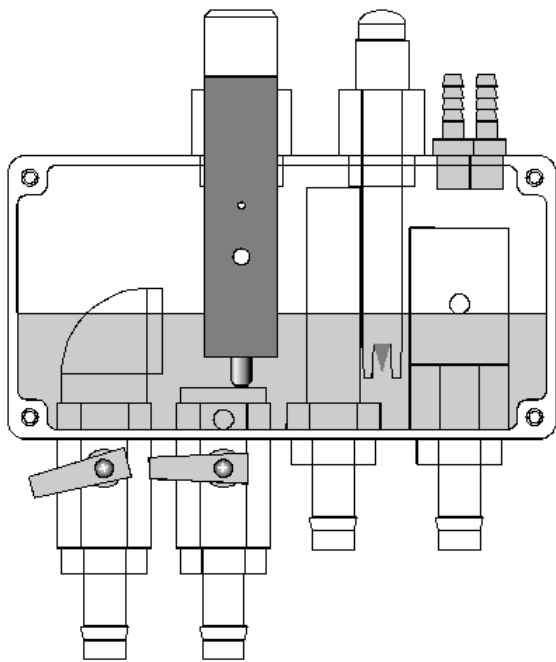

X
Flow too low

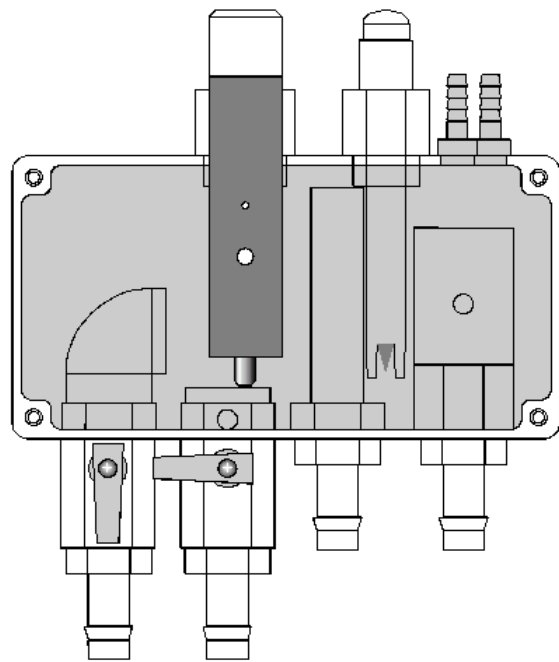

X
Flow too high

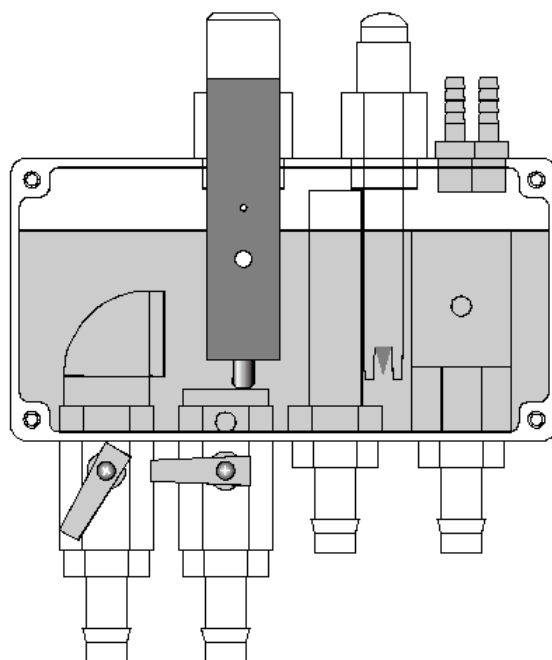

✓
Flow OK

11. Peristaltic Pumps

This section is applicable to the **hydroCHEM-DS** (part number 111109), which is supplied with peristaltic dosing pumps.

IMPORTANT INFORMATION REGARDING ACID

- Always use dilute Acid.
- Add 5 Litres of Acid to 15 or more litres of water.
- NEVER ADD WATER TO ACID
- Using concentrated acid may damage your equipment and void the warranty

11.1 Commissioning the Peristaltic Pumps

Three peristaltic pumps are built onto the pump box – Nutrient A, Nutrient B and pH. The **hydroCHEM** is normally configured to add Acid, but it can also be set to add Base. Commissioning is a simple 5 step process...

1. Connect the Power Cable.

The **hydroCHEM-DS** is supplied with a pump power cable, part number 130104. Plug one end into the **Control Output** socket on the **hydroCHEM** unit, and the other end into the socket on the pump box. See the diagrams in sections 1.1 and 1.2.

2. Connect the Input Tubing.

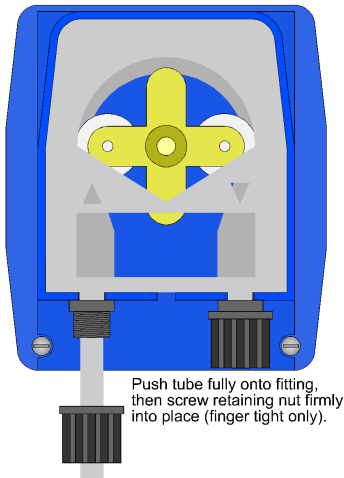

The input tubing is the semi-rigid tubing, part number 116358. Connect this to the tube fitting on the LEFT side of the each pump. The compression fitting makes it easy to connect the tubing securely.

3. Connect the Feed Drum Weight

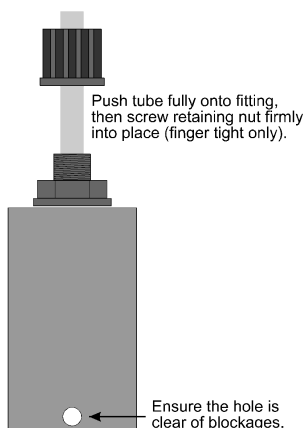

The **hydroCHEM-DS** is supplied with a small plastic weight for each pump. This weight is to be attached to the Feed Drum end of the suction tube, and ensures that the Input Tubing is always immersed in solution.

For systems where there may be sediment or large amounts of suspended solids which settle at the bottom of the drum, ensure that the weight is hanging up off the floor of the drum.



4. Connect the Output Tubing.

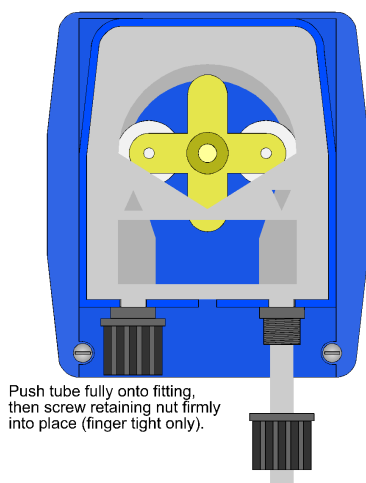

The output tubing is the softer flexible tubing, part number 116360. Connect this to the tube fitting on the RIGHT side of each pump. The compression fitting makes it easy to connect the tubing securely.

5. Test the pump operation.

Once the pumps have been connected and the tubing fitted, their operation should be checked. TPS recommends that this be done by pumping from a container of fresh water in case any of the fittings are leaking, avoiding the possibility of corrosive and/or dangerous chemical spillage. Use the Quick Dose function (see section 4) to test the pump operation. It only takes around 25 seconds to prime the pumps, so the Quick Dose time can be set to 1 minute.

6. Fine-tune the A & B Pumping Ratio

It is normal to obtain slightly different flow rates from pump to pump. The A & B Fine Tune control is provided on the underside of the pump box to allow the user to adjust the pumps to obtain a 1:1 output. Use the Quick Dose function (see section 4) to run the pumps for a reasonable length of time (5 minutes should suffice). Measure the output of each pump and adjust the control for More A or More B accordingly. Repeat the test to ensure the adjustment was correct. The performance of the pumps will vary over time due to normal wear and build-up of undissolved solids. TPS recommends that this fine tuning is repeated from time to time to ensure the 1:1 A & B ratio.

11.2 Lubricating the Pump Tubing

The **hydroCHEM-DS** is shipped with the correct lubrication on the peristaltic pump tubing. This lubrication should be re-applied every year. Suitable Silicon lubricant is available from TPS in a 3mL syringe (part no 130103).

To lubricate the pump tubing...

1. Remove the pump tubing, as per the details in section 11.4, below.
2. Smear a small quantity of Silicon grease all around the tube. A thin film is all that is required.

NOTE DO NOT use petroleum based oil or lubricants, as these will cause the Santoprene rubber to perish. Use only Silicon based lubricant.

11.3 PumpFault Error Message

The hydroCHEM monitors the dosing pump current usage and will detect problems with the pump before damage can occur. If excess current is detected the unit will beep and display **PumpFault** in the status window for Cond. or pH. No further dosing of the chemical will occur and steps should be taken to eliminate the fault.

Turn the unit OFF and check the pump tubing for kinks and ensure that the output tube is not obstructed. A worn / faulty gearbox and motor can cause high current usage and will require replacement.



The error message will be reset by turning the unit off or by pressing the Menu key. The fault will re-occur the next time dosing is required if the cause has not been eliminated.

11.4 Replacing the Pump Tubing

Replace the Pump Tubing if it gets worn, begins to leak, or pumping volume is reduced. The Pump Tubing may be replaced every year as a precautionary measure.

To remove the old Pump Tube...

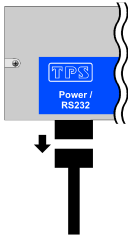
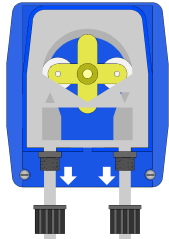
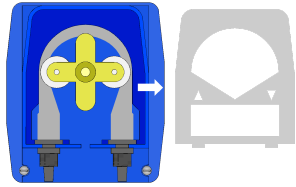
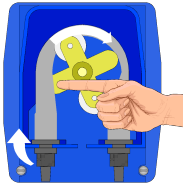
1	2	3	4
			
<p>Disconnect the power supply from the hydroCHEM unit.</p>	<p>Remove the Input and Output tubing from the compression fittings. This is simply a reversal of the procedure detailed in section 11.1.</p>	<p>Remove the see-through protector plate on the front of the pump.</p>	<p>Turn the roller holder so that the rollers are in a horizontal line. Pull the left hand side compression fitting from its seat. Begin turning the roller holder clockwise, so that the roller holder acts as a lever which pulls the pump tube out as it turns. After approximately 3/4 of a turn, the right hand side compression fitting can be pulled out.</p> <p>The old pump tube has now been removed.</p>

To fit a new Pump Tube...

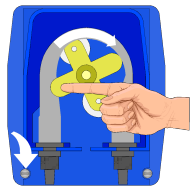
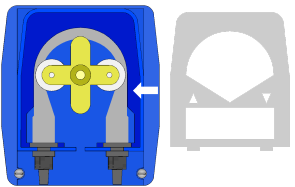
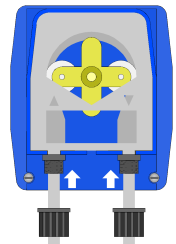
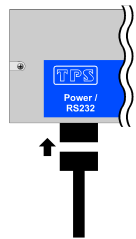
1	2	3	4
			
<p>Turn the roller holder so that the rollers are in a horizontal line. Push the left hand side compression fitting into its seat, round side facing in. Begin turning the roller holder clockwise, so that the roller holder acts as a lever which pushes the pump tube in as it turns. After approximately 3/4 of a turn, the right hand side</p>	<p>Replace the see-through protector plate on the front of the pump. This is essential to protect the rollers and tube from dirt and moisture.</p>	<p>Re-fit the Input and Output tubing to the compression fittings. See the procedure detailed in section 11.1.</p>	<p>The hydroCHEM unit's power supply can now be re-connected.</p>



<p>compression fitting can be pushed in, round facing in. The new pump tube has now been fitted.</p>			
--	--	--	--

12. Control Outputs

This section is applicable to the **hydroCHEM** (part number 111103), which is supplied with a three-way control output cable (part number 130105).

12.1 Output Cable Connections

The three-way control output cable connections are as follows...

Colour	Function
Black	Common for all three outputs
White	Nutrient A output
Blue	Nutrient B output
Red	pH Adjustor output

12.2 Control Output Specifications

The control outputs on the **hydroCHEM** are 24V DC at low current. They are provided to enable the **hydroCHEM** to switch external relays which in turn switch on the relevant pumps. Relays should be selected according to the voltage and current loading requirements of the pumps to be used.

Any mains power wiring to the relays and pumps must be carried out by a qualified electrician.

The load currents of the control outputs are monitored by the **hydroCHEM** to avoid any damage to the unit. If the current exceeds 160mA for each output that is activated the message **PumpFault** will be displayed and the output/s will be turned off. No further dosing will occur and steps should be taken to eliminate the fault.



13. Password Security

The password security feature prevents unauthorised persons from accessing any of the menu functions of the **hydroCHEM**.

13.1 Enabling the Password Security function.

1. Select the Password menu ( → **F5:System** → **F1:Password**).
2. Select **F3:Enable Security & Enter Code** from the menu.
3. The **hydroCHEM** now prompts you to enter a 4 digit password...

Enter NEW 4 digit access code : _
Press F1, F2, F3, F4, F5 to Enter code

Press any combination of 4 of the  to  keys. Any of the keys may be repeated as often as you wish. You do not need to press  after pressing the 4th key.



4. The **hydroCHEM** now prompts you to re-enter the password for verification...

Enter NEW 4 digit access code : _
Now Re-Enter for Verification

Re-enter the 4 digit password. You do not need to press  after pressing the 4th key.

5. The **hydroCHEM** now confirms that Security Access is enabled before returning to the Password menu.



13.2 Using the Password Security function

When the Password Security function is enabled (as per section 13.1), the **hydroCHEM** prompts the operator to enter the password whenever the  key is pressed in normal display mode. No further password entry is required to access any of the menu functions. It is therefore imperative never to remain in any of the menus when leaving the unit. Always press the  key until the **hydroCHEM** is in normal display mode before leaving the unit.

Notes



1. If you wish to write the Password down, it is advisable to do so somewhere away from the unit.
2. If you forget the Password, please contact TPS. Once we have established your ownership of the unit, we will be able to give you an access code. We will need the serial number of the unit to provide this code.

13.3 Changing the Password

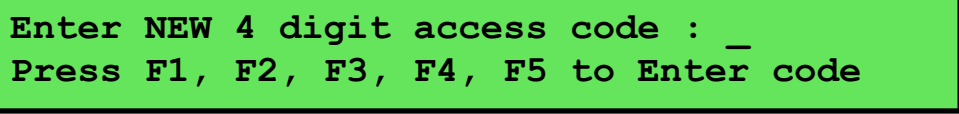
1. Select the Password menu ( → **F5: System** → **F1: Password**).
(Of course, you will need to enter the current password after pressing the  key.)
2. Select **F1: Change Code** from the menu.
3. The **hydroCHEM** now prompts you to enter a new password...



```
Enter NEW 4 digit access code : _
Press F1, F2, F3, F4, F5 to Enter code
```

Press any combination of 4 of the  to  keys. Any of the keys may be repeated as often as you wish. You do not need to press  after pressing the 4th key.

6. The **hydroCHEM** now prompts you to re-enter the password for verification...

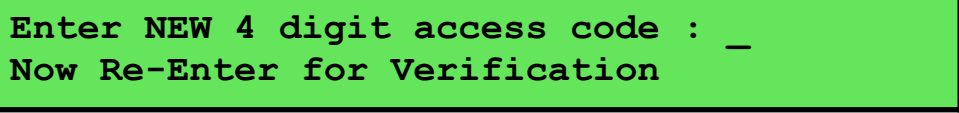



```
Enter NEW 4 digit access code : _
Now Re-Enter for Verification
```

Re-enter the 4 digit password. You do not need to press  after pressing the 4th key.

4. The **hydroCHEM** now confirms that the new Password has been saved before returning to the Password menu.

13.4 Disabling the Password Security function

1. Select the Password menu ( → **F5: System** → **F1: Password**).
(Of course, you will need to enter the current password after pressing the  key.)
2. Select **F3: Disable Security** from the menu.
3. The **hydroCHEM** now confirms that Security Access has been disabled before returning to the Password menu.

14. Good Laboratory Practices (GLP)



To comply with GLP guidelines, the **hydroCHEM** keeps a record of the last Conductivity (or TDS), pH, and Temperature calibrations plus all system set-up information. This information is retained in memory when the **hydroCHEM** is switched off, even when the power supply is removed.

14.1 Recalling Calibration information on the display

1. Select the GLP menu ( → **F5:System** → **F2:GLP**).
2. Select **F1:Recall Cal.** from the menu.
3. The instrument model, firmware version number, and instrument serial number are displayed, along with a prompt describing how to scroll through the Calibration information.

The date and time are displayed only when the Plus-Pack is fitted.

```
hydroCHEM+ V4.1 S1234 @ 31/12/10 12:00
                ↑:Next
```

4. Press the  key to sequentially scroll through the Calibration information for all parameters. Press the  key to scroll back to previous data. The sequence of information displayed is shown below. Press  to abort at any time.

Calibration Data Display sequence...

```
hydroCHEM+ V4.1 S1234 @ 31/12/10 12:00
                ↑:Next
```

```
Cond. Zero=0.00mS/cm      31/12/10 10:00
Cond. Calibrated          ↑:Next ↓:Back
```

```
Cond. Span=100.0%       31/12/10 10:10
Cond. Calibrated          ↑:Next ↓:Back
```

```
pH Asymmetry=0.10pH     31/12/10 10:20
pH Calibrated            ↑:Next ↓:Back
```

```
pH Slope=100.0%         31/12/10 10:30
pH Calibrated            ↑:Next ↓:Back
```

```
Temperature Offset=0.1°C 31/12/10 10:40
Temp. Calibrated         ↑:Ends ↓:Back
```

14.2 Printing Calibration information to the RS232 Port

The GLP information stored in the instrument's memory can be sent to a printer or PC via the RS232 port. This function is available only when the Plus-Pack is fitted.

1. Ensure that the **hydroCHEM** RS232 cable is connected to the instrument and to the printer or PC.
2. Select the GLP menu ( → **F5: System** → **F2: GLP**).
3. Select **F2: Print Cal.** from the menu.

The message "**Printing GLP Data**" is displayed while sending the data to the RS232 port.

4. The Calibration information is sent to the RS232 port in formatted ASCII text. For example...



```
hydroCHEM V4.1 S1234 @ 31/12/2010 12:00
Cond.      Zero=      0.00mS/cm @ 31/12/2010 10:00
Cond.      Span=      100.0%   @ 31/12/2010 10:10
pH         Asy=       0.10pH   @ 31/12/2010 10:20
pH         Slope=     100.0%   @ 31/12/2010 10:30
Temperature Offset=  0.1oC    @ 31/12/2010 10:40
ENDS
```

14.3 Recalling System information on the display

1. Select the GLP menu ( → **F5: System** → **F2: GLP**).
2. Select **F3: Recall Sys.** from the menu.
3. The instrument model, firmware version number, and instrument serial number are displayed, along with a prompt describing how to scroll through the System information. For example...

```
hydroCHEM+ V4.1 S1234           ↑:Next
@ 31/12/10 12:00
```

(The date and time are displayed only when the Plus-Pack is fitted.)

4. Press the  key to sequentially scroll through the System information for all parameters. Press the  key to scroll back to previous data. The sequence of information displayed is shown over the page. Press  to abort at any time.

System Data Display sequence...

hydroCHEM+ V4.1 S1234 ↑:Next
@ 31/12/10 12:00

Cond. Zero=0.00mS/cm ↑:Next
Cond. Span=100.0% ↓:Back

pH Asymmetry=0.10pH ↑:Next
pH Slope=100.0% ↓:Back

Temperature Offset=0.1°C ↑:Next
 ↓:Back

Primary Buffer=7.00pH ↑:Next
Secondary Buffers=4.01/9.18pH ↓:Back

Cond. Dosing Hours=0 ↑:Next
pH Dosing Hours=0 ↓:Back

Alarms Enabled ↑:Next
 ↓:Back

Cond. Limit=2.0mS/cm Add if Low ↑:Next
Cond. Sensitivity=Medium ↓:Back

Cond. ON Time=15 mins ↑:Next
Cond. OFF Time=5 mins ↓:Back

Cond. ShutOFF Timer=60 mins ↑:Next

Cond. A Quick Dose Time=5 mins ↑:Next
Cond. B Quick Dose Time=5 mins ↓:Back



Continued over the page...

System Data Display sequence. continued...

Cond. Alarm Margin=0.30mS/cm ↑:Next
Cond. Alarm Delay Time=10 minutes ↓:Back

Cond. High Alarm=2.30mS/cm ↑:Next
Cond. Low Alarm=1.50mS/cm ↓:Back

pH Limit=6.5pH Add if High ↑:Next
pH Sensitivity=Medium ↓:Back

pH ON Time=10 mins ↑:Next
pH OFF Time=5 mins ↓:Back

pH ShutOFF Timer=15 mins ↑:Next
pH Quick Dose Time=5 mins ↓:Back

pH Alarm Margin=0.3pH ↑:Next
pH Alarm Delay Time=10 mins ↓:Back

pH High Alarm=7.0pH ↑:Ends
pH Low Alarm=6.2pH ↓:Back

When the Plus-Pack is fitted, an additional screen showing the currently selected RS232 baud rate is provided.



14.4 Printing System information to the RS232 Port

The System information stored in the instrument's memory can be sent to a printer or PC via the RS232 port. This function is available only when the Plus-Pack is fitted.

1. Ensure that the **hydroCHEM** RS232 cable is connected to the instrument and to the printer or PC.
2. Select the GLP menu ( → **F5: System** → **F2: GLP**).
3. Select **F4: Print Sys.** from the menu.

The message "**Printing System Data**" is displayed while sending the data to the RS232 port.

4. The System information is sent to the RS232 port in formatted ASCII text. For example...

```
hydroCHEM V4.1 S1234 @ 31/12/2010 12:00
Cond.      Zero=      0.00mS/cm @ 31/12/2010 10:00
Cond.      Span=      100.0%   @ 31/12/2010 10:10
pH         Asy=       0.10pH   @ 31/12/2010 10:20
pH         Slope=     100.0%   @ 31/12/2010 10:30
Temperature Offset=  0.1oC    @ 31/12/2010 10:40
Primary Buffer=7.00pH
Secondary Buffers=4.01/9.18pH
Cond. Dosing Hours=(total operating hours of Conductivity pumps)
pH Dosing Hours=(total operating hours of pH pump)
Alarms Enabled (or Disabled)
Flow Detection by Cond.
Cond. Limit=2.0mS/cm Add if Low
Cond. Sensitivity=Medium
Cond. ON Time=15 mins
Cond. OFF Time=5 mins
Cond. ShutOFF Timer=60 mins
Cond. A Quick Dose Time=5 mins
Cond. B Quick Dose Time=5 mins
Cond. Alarm Margin=0.3mS/cm
Cond. High Alarm=2.3mS/cm
Cond. Low Alarm=1.5mS/cm
Cond. Alarm Delay Time=10 mins
pH Limit=6.5pH Add if High
pH Sensitivity=Medium
pH ON Time=10 mins
pH OFF Time=5 mins
pH ShutOFF Timer=15 mins
pH Quick Dose Time=5 mins
pH Alarm Margin=0.3pH
pH High Alarm=7.0pH
pH Low Alarm=6.2pH
pH Alarm Delay Time=10 minutes
Baud Rate=9600
ENDS
```



14.5 Failed Calibration

If calibration has failed, the **hydroCHEM** displays the message "Un-Calibrated" for any parameter that has failed calibration. The date and time for the failed calibration is reset to zero when the Plus-Pack is fitted. The **hydroCHEM** still shows the results for the last successful calibration, as shown in the following example...

1. Failed Conductivity span calibration for standard **hydroCHEM**...

```
Cond. Span= 95.0%
Cond. Un-Calibrated      ↑:Next  ↓:Back
```

2. Failed pH Asymmetry Calibration for **hydroCHEM** with Plus-Pack fitted...

```
pH Asymmetry=0.10pH      00/00/00 00:00
pH Un-Calibrated         ↑:Next  ↓:Back
```

14.6 Instrument Serial Number

In case the serial number that is fitted to the **hydroCHEM** is removed or becomes illegible, it is also available on the **hydroCHEM** display.

1. The serial number is displayed at turn-on, for example...

```
hydroCHEM+ V4.1 S1234      (C) 2011 TPS P/L
Hydroponics Controller
```

The "+" after **hydroCHEM** is shown when the Plus-Pack is fitted

2. The serial number is displayed when recalling the Calibration or System information (sections 14.1 and 14.3).
3. The serial number is included on the printout of Calibration or System information (sections 14.2 and 14.4).
4. The GLP information can be downloaded to a PC using the optional Windows ® software (part number 130086).

14.7 Additional GLP Features

Another GLP requirement is to record the date and time of every reading. The **hydroCHEM** does this for you when readings are recorded either with the Notepad function (section 15.1) or the Automatic Logging function (section 15.2). These functions are available only when the Plus-Pack is fitted.

15. Datalogging Function

The Datalogging function is available only when the Plus-Pack is fitted.

15.1 Recording readings manually

To manually record readings into memory...

1. Press **F1** in normal display mode. The display should now look like this example...

```

1.9mS/cm (2.0)      6.6pH (6.5)      25.0°C
Log# 1, Press F1      12:00
  
```

2. Press **F1** to record Conductivity/TDS, pH, Temperature, Date and Time into memory. This will be labelled as reading number 1.

Alternatively, press **Menu** to quit without recording the reading.

3. Repeat steps 1 & 2 as often as required. The maximum number of readings that can be stored in the Notepad is 2300.

15.2 Recording readings automatically

The **hydroCHEM** can automatically log records into memory or to the RS232 port. First the logging period must be programmed, then automatic logging can be started and stopped as required.

To program the logging period...

1. Select the Logger menu (**Menu** → **F4:Logger**).
2. Select **F4:Program** from the menu.

The display should now look similar to that shown below. The current Logging Period is displayed.

```

Enter Logging Period : 1 Hour
Press ↑↓ to select period
  
```

3. Use the **Up** and **Down** keys to set the period at which the **hydroCHEM** will automatically log records into memory or to the RS232 port. The available logging periods are 1, 2, 5, 10, 15, 20 and 30 minutes and 1, 2, 3, 4, 6, 8, 12 and 24 hours. These periods have been chosen because they divide evenly into a 24 hour day.
Press **Enter** to save the Logging Period.
Press **Menu** to quit without changing the current setting.
4. The automatic logging function is now programmed and can be enabled or disabled as required.

To enable automatic datalogging...

1. Select the Logger menu ( → **F4:Logger**).
2. Select **F5:Enable** from the menu to enable automatic datalogging.
3. The **hydroCHEM** now confirms that automatic datalogging is enabled, and gives you the choice of logging into memory, or sending readings directly to the RS232 port...

Data Logging Enabled
F1:Log Data F2:Send to RS232

Press  to log the data into the **hydroCHEM** memory whenever a reading is due.

Press  to send the data directly to the RS232 port whenever a reading is due.

NOTE: The  key is not available to quit at this point, as logging has already been enabled.

4. The **hydroCHEM** calculates a "logical" time for the next reading to be logged, so that readings are logged at even times during the 24 hour day.

For example, if the logging period is set to 2 hours, the **hydroCHEM** will log at 12:00, 2:00, 4:00 etc. Even if logging is enabled at an odd time such as 12:23, the unit will wait until 2:00 before recording the first reading. This feature makes data much easier to examine visually later.

5. When logging data into memory, the **hydroCHEM** alternates between the next log number and the time the next reading is due to be logged on the display.

When sending data to the RS232 port, the **hydroCHEM** alternates between the word "**#Send**" and the time the next reading is due to be sent on the display.

To disable automatic datalogging...

1. Select the Logger menu ( → **F4:Logger**).
2. Select **F5:Disable** from the menu to enable automatic datalogging.
3. The **hydroCHEM** confirms that automatic datalogging has been disabled.

15.3 Recalling Readings from the Notepad



To recall records from memory onto the **hydroCHEM** display...

1. Select the Logger menu ( → **F4:Logger**)
2. Select **F1:Recall** from the menu.



Record number 1 is now displayed.

For example...

1.8mS/cm Offline 7.6pH OK 25.0°C
Log#1, 31/12/10 12:00

3. Press  to display the next record.
 Press  to display the previous record.



Press and hold the  key while pressing the  and  keys to roll rapidly through the readings.

Press  to send the displayed record to the RS232 port.

15.4 Erasing Records from the Notepad



To erase records from the Notepad...

1. Select the Logger menu ( → **F4:Logger**).
2. Select **F2:Eraser** from the menu.
3. The **hydroCHEM** now displays the Erase menu, for example...

```

Erase Log, ( 2300 ) Select Option
F1:Eraser All  F2:Eraser Last  Menu Exits
  
```



The number of readings stored in memory is displayed. See the “2300” in the example above.

4. Press  to erase all of the readings stored in the Notepad.
Press  to erase the last recorded reading only.
Press  to quit without erasing any records.

15.5 Printing Records from the Notepad to the RS232 Port

1. Connect one end of the RS232 cable to the **Power/RS232** socket of the **hydroCHEM**.
733068936. Connect the other end of the RS232 cable to an RS232 Printer, or to the COM1 or COM2 ports of a PC.
733068937. Ensure that the baud rate for the printer or PC and the **hydroCHEM** are the same. If necessary, alter the baud rate of the **hydroCHEM** (see section 16.1).

The **hydroCHEM** uses XON/XOFF protocol. Ensure that the printer is set accordingly.

733068938. Select the Logger menu ( → **F4:Logger**).
733068939. Select **F3:Print** from the menu.
733068940. Printing starts as soon as  is pressed. The following screen is displayed while the readings are being sent to the RS232 port...

```

Printing Data . . .
                                Press Menu to Quit
  
```

Press  at any time to stop sending the readings to the RS232 port.

16. RS232 Port





This section is applicable when the Plus-Pack is fitted.

16.1 Setting the Baud Rate

1. Select the Baud rate menu ( → **F5: System** → **F4: Baud**).
2. The available baud rates are listed, along with the RS232 port configuration...

```
Baud Rate:   F1:300  >F2:9600   F3:19200
8 bits, No Parity, 1 Stop bit, XON/XOFF
```

The arrow indicates the current selection.

3. Press  to select 300 baud.
Press  to select 9600 baud.
Press  to select 19200 baud.
Press  to quit and retain the current setting.

16.2 Sending Readings to the RS232 Port

Press  to instantly send readings to the RS232 port whenever the **hydroCHEM** is in normal display mode.

Records can be sent directly to the RS232 port rather than stored in memory during automatic datalogging. See section 15.2 for details.

Press  while recalling data on the display (see section 15.3) to send that record to the RS232 port.

16.3 RS232 Configuration

The **hydroCHEM** RS232 configuration is 8 Bits, No Parity, 1 Stop Bit, XON/XOFF Protocol.

This information is displayed when setting the baud rate (see section 16.1)

16.4 Communication and Statistical Software

Communication between the **hydroCHEM** and a PC can be handled with any RS232 communication software. A TPS communication software package for Windows[®] is optionally available (part number 130086).

Once the data is saved to disk, the next problem is how to use it. The data sent by the **hydroCHEM** is formatted in fixed-width columns that can be imported by programs such as Microsoft[®] Excel[®] and Lotus 123[®].

Help on importing the data into Microsoft[®] Excel[®] is provided in section 16.8 and the “excel.txt” file in the folder where you installed the WinTPS program.



16.5 Commands

The following commands can be sent from a PC to the **hydroCHEM**. Note that <cr> denotes carriage return and <lf> denotes a line feed.

Action	Command	Notes
Request current data	?D<cr>	Returns the current Conductivity/TDS, pH and Temperature data, Control status, date and time from the hydroCHEM . The log number returned is set to Zero.
Request logged data	?R<cr>	Returns all logged records from the hydroCHEM memory. The data ends with the message ENDS <cr>
Erase logged data	?E<cr>	Erases all logged records from the hydroCHEM memory. Returns the message ERASED <cr> to confirm that the records have been erased.
Request status information	?S<cr>	Returns the model name, firmware version number, instrument serial number and number of logged readings in memory, for example... hydroCHEM ◇ V4.1 ◇ S1234 ◇ 2300 <cr>, where ◇ are spaces. Note that the number of logged readings is right-justified.
Request GLP information	?G<cr>	Returns all calibration and system set-up information, instrument model, serial number and current date (see section 16.7 for data format and handshaking).
Positions of Data Fields	?P<cr>	Returns the number of data fields, along with their position and length. 10,1,10,12,5,18,4,23,6,35,7,43,3,47,6,56,7,64,3,68,5 This denotes 10 fields, the first of which is at column 1 and is 10 characters long. The second field is at column 12 and is 5 characters long and so on. This function is primarily provided to assist software developers.
Data Column Header	?H<cr>	Returns a text string which can be used to provide headers for each data field. Spaces are included to ensure that the headers are correctly aligned with the data. This function is primarily provided to assist software developers.



16.6 Data Format

Data is returned to the RS232 Port by the **hydroCHEM** in the following format...

dd/mm/yyyy•hh:mm•LLLL•CCCCCCcccc•SSSSSS•123•PPPPPPpp•SSSSSS•123•TTTTTt

where....

dd/mm/yyyy is the date, month and year data. The year is sent as 4 digits for Year 2000 compliance.

- is one space

hh:mm is the hours and minutes data.

LLLL is the Log Number, 4 characters, right justified. The **hydroCHEM** sends a Zero for instant readings (see section 16.2).

- is one space

CCCCCC is the Conductivity/TDS data, 6 characters, right justified. The data is replaced by 6 spaces when there is no flow through the sample chamber.

cccc is the Conductivity/TDS unit description, which can be any one of the following...

mS/cm	for millisiemens per centimetre in Conductivity mode.
CF•••	for CF Units in Conductivity mode.
dS/M•	for decisiemens per metre in Conductivity mode.
ppK••	for parts per Thousand in TDS mode.
("•" is one space.)	

- is one space.

SSSSSS is the Conductivity Control Status.

- is one space.

123 is Conductivity Alarm Status.

1 can be A for Data Outside Alarm Margin
 O for Data Over-Range
 Space for Data OK.
2 can be S for Emergency ShutOFF
 Space for OK.
3 can be P for Pump Fault
 Space for Pump OK.

- is one space.

PPPPPP is the pH data, 6 characters, right justified. The data is replaced by 6 spaces when there is no flow through the sample chamber.

pp is the pH unit description, sent as "**pH**".

- is one space.

SSSSSS is the pH Control Status.



- is one space.



123 is pH Alarm Status.
1 can be A for Data Outside Alarm Margin
O for Data Over-Range
Space for Data OK.
2 can be S for Emergency ShutOFF
Space for OK.
3 can be P for Pump Fault
Space for Pump OK.

• is one space.

TTTTT is Temperature data, 5 characters, right justified.
The data is replaced by 6 spaces when there is no flow through the sample chamber.

tt is the unit description, sent as “**oC**”.

When requested by a PC with the ?D or ?R commands (section 16.5), the data is terminated with a carriage return.

When the data is sent by the **hydroCHEM** using the Print function (section 15.5) or the Instant Send function (section 16.2), the data ends with a carriage return and a line feed.



16.7 GLP Data Format

Calibration and system information is returned as 21 lines terminated by a carriage return. When using the “?G” command (section 16.5), the computer must respond with a character after receiving each line.

For example...

```
hydroCHEM V4.1 S1234 @ 31/12/2010 12:00
Cond.      Zero=      0.00mS/cm @ 31/12/2010 10:00
Cond.      Span=      100.0%   @ 31/12/2010 10:10
pH         Asy=       0.10pH   @ 31/12/2010 10:20
pH         Slope=     100.0%   @ 31/12/2010 10:30
Temperature Offset=  0.1oC    @ 31/12/2010 10:40
Primary Buffer=7.00pH
Secondary Buffers=4.01/9.18pH
Cond. Dosing Hours=(total operating hours of Conductivity pumps)
pH Dosing Hours=(total operating hours of pH pump)
Alarms Enabled (or Disabled)
Flow Detection by Cond.
Cond. Limit=2.0mS/cm Add if Low
Cond. Sensitivity=Medium
Cond. ON Time=15 mins
Cond. OFF Time=5 mins
Cond. ShutOFF Timer=60 mins
Cond. A Quick Dose Time=5 mins
Cond. B Quick Dose Time=5 mins
Cond. Alarm Margin=0.3mS/cm
Cond. High Alarm=2.3mS/cm
Cond. Low Alarm=1.5mS/cm
Cond. Alarm Delay Time=10 mins
pH Limit=6.5pH Add if High
pH Sensitivity=Medium
pH ON Time=10 mins
pH OFF Time=5 mins
pH ShutOFF Timer=15 mins
pH Quick Dose Time=5 mins
pH Alarm Margin=0.3pH
pH High Alarm=7.0pH
pH Low Alarm=6.2pH
pH Alarm Delay Time=10 minutes
Baud Rate=9600
ENDS
```

16.8 Importing Data into Microsoft Excel

The following procedure details the method for importing a **hydroCHEM** text data file into Microsoft® Excel®.

1. Start Microsoft® Excel® and select **File** → **O**pen.
2. In the “Files of type:” pull-down box, choose “Text Files (*.prn; *.txt; *.csv)”.
3. Navigate to the folder where your data file is stored and double-click it to start the Text Import Wizard.

Note : The default data folder for the WinTPS software is “C:\My Documents\WinTPS”.

4. In step 1 of the Text Import Wizard, select “Fixed width” as per the sample screen below, then press “Next >”.

Note that the data column headers in row one appear only when the data is downloaded using the WinTPS software.

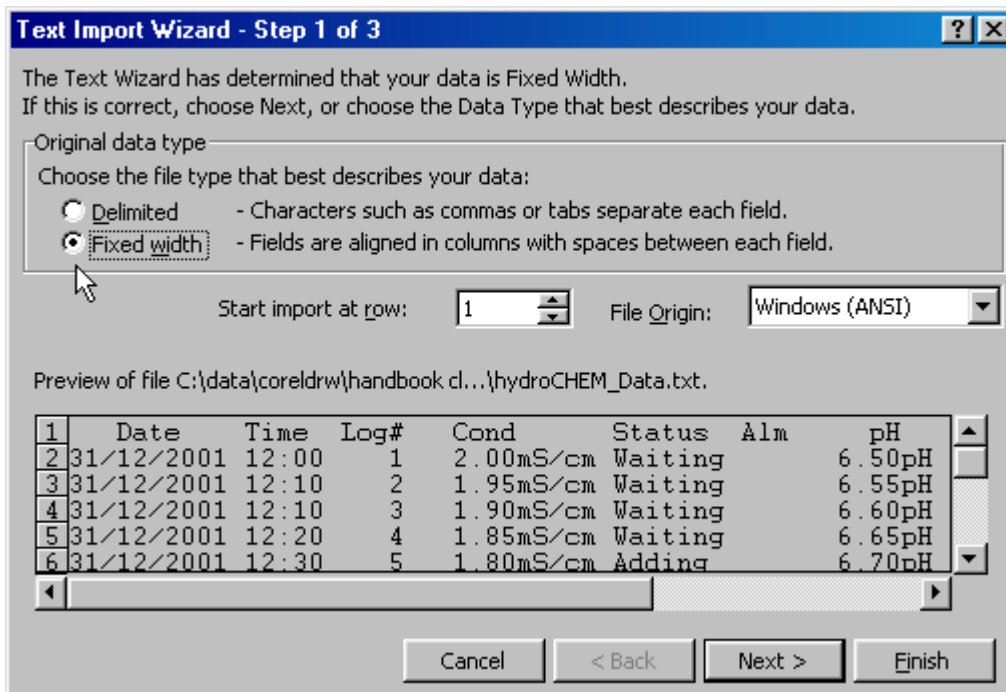

Text Import Wizard - Step 1 of 3

The Text Wizard has determined that your data is Fixed Width.
If this is correct, choose Next, or choose the Data Type that best describes your data.

Original data type

Choose the file type that best describes your data:

Delimited - Characters such as commas or tabs separate each field.

Fixed width - Fields are aligned in columns with spaces between each field.

Start import at row: File Origin:

Preview of file C:\data\coreldrw\handbook cl...\hydroCHEM_Data.txt.

1	Date	Time	Log#	Cond	Status	Alm	pH
2	31/12/2001	12:00	1	2.00mS/cm	Waiting		6.50pH
3	31/12/2001	12:10	2	1.95mS/cm	Waiting		6.55pH
4	31/12/2001	12:10	3	1.90mS/cm	Waiting		6.60pH
5	31/12/2001	12:20	4	1.85mS/cm	Waiting		6.65pH
6	31/12/2001	12:30	5	1.80mS/cm	Adding		6.70pH

Buttons: Cancel, < Back, Next >, Finish

Continued over the page...

- Step 2 of the Text Import Wizard allows you to select the points at which each data field will break into a new column. The sample screens below show where TPS recommends the breaks be inserted. There are two screens, as the width of the data requires the window to be scrolled over.

The date and time have been incorporated into a single column to ensure that the X-axis is correctly formatted if the data is to be charted later.

Press “Next >” after all the column breaks have been inserted.

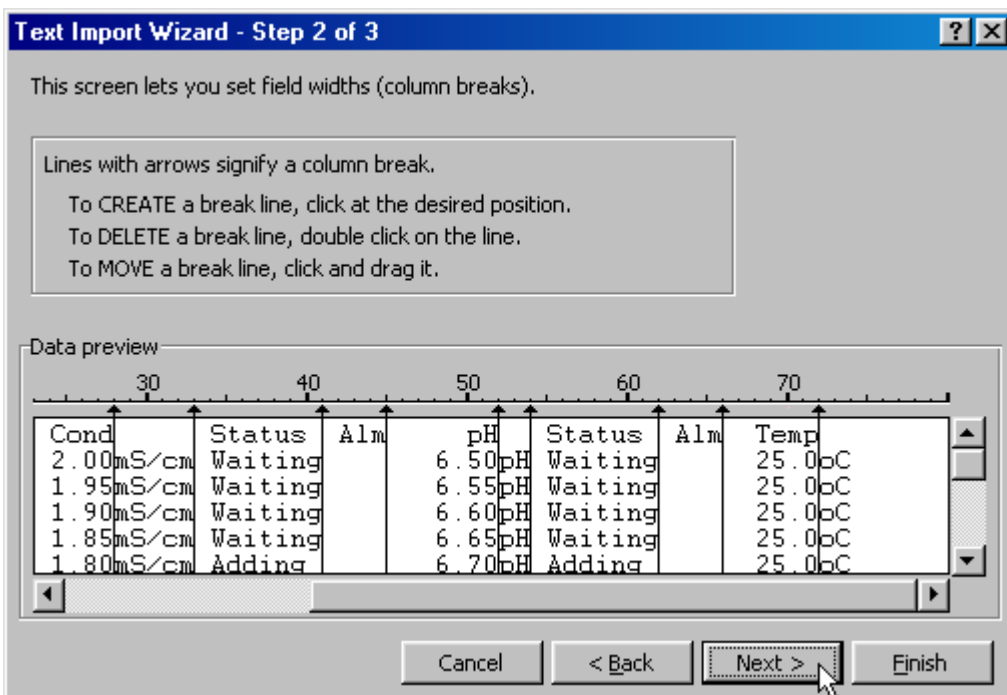
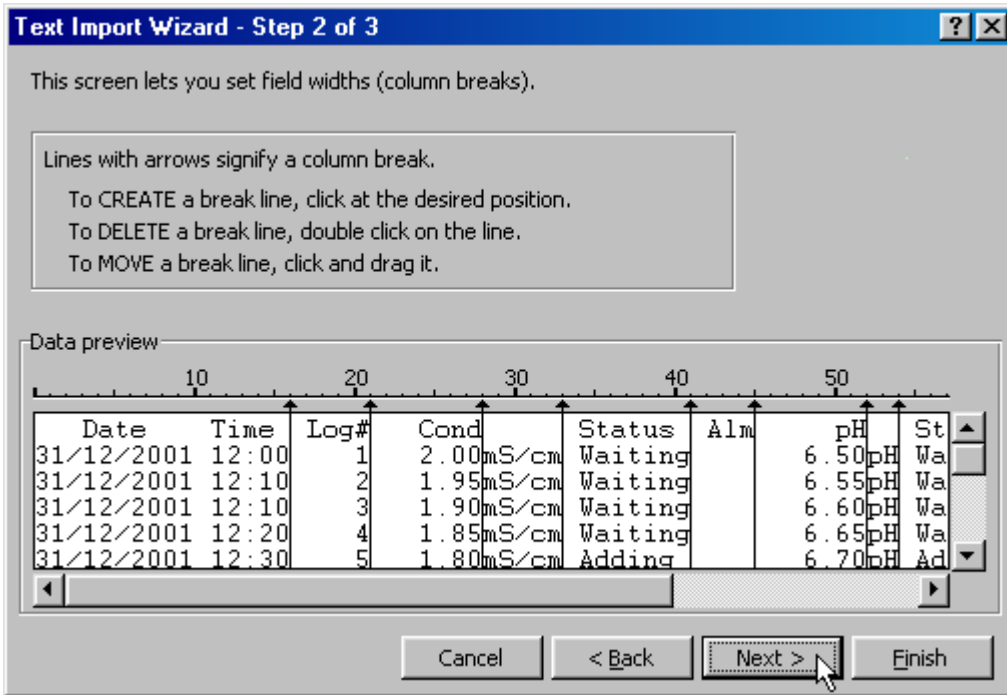

- Simply press “Finish” at step 3 of the Text Import Wizard. TPS recommends that the data format for each column be set once the data is in spreadsheet format.





For help on formatting the data columns, charting, graphing or other operations please consult the Microsoft® Excel® help file. Alternatively please contact TPS and we will try to provide further assistance.

17. Setting the Clock



1. Select the Clock Set-up menu ( → **F5:System** → **F3:Clock**)
2. The Clock Set screen is now displayed, with the current date and time. The cursor is on the day of the month. For example...



```
Set Clock   31/12/10 12:00
Press Enter to Save, menu to Quit
```





Use the  and  keys to set the day of the month.

Press the  key to move to the month, then use the  and  keys to set the month.

Press the  key to move to the year, then use the  and  keys to set the year.

Press the  key to move to the hours, then use the  and  keys to set the hours.

Press the  key to move to the minutes, then use the  and  keys to set the minutes.

3. If any corrections are required, use the  and  keys to move the cursor between the various elements of the date and time.
4. Press  to save the new date and time.
5. Alternatively, press  to quit and retain the current setting.

Notes

1. The **hydroCHEM** tests that a valid day of the month is entered. If an invalid date is entered (eg. 31/09/10), the **hydroCHEM** beeps and displays the message “**Invalid Date**”. The meter then returns to the clock setting screen, so that the correct date can be entered.
2. The **hydroCHEM** also tests for leap years.
3. The microprocessor in the **hydroCHEM** only stores the year to two digits, however this presents no Year 2000 problems. The TPS software automatically converts the date to four digits when downloading data.

18. Selecting the Conductivity/TDS units





The **hydroCHEM** can display Conductivity in mS/cm, CF units and dS/m. It can also display TDS in ppK.

To select the Conductivity/TDS units...

1. Select the Units menu ( → **F5:System** → **F5:Setup** → **F1:Units**)...



The arrow indicates the current selection.

2. Press  to display Conductivity in mS/cm (millisiemens per centimetre).
Press  to display TDS in ppK (parts per Thousand).
Hint: Multiply this reading by 1000 for ppm (parts per Million)
Press  to display Conductivity in CF units.
Press  to display Conductivity in dS/m (decisiemens per metre).
Press  to quit and retain the current setting.
3. The **hydroCHEM** confirms the selected units before returning to the Setup menu.

19. Selecting Display Resolution



This section is applicable when the Plus-Pack is fitted.

To select low or high display resolution, when the Plus-Pack is fitted...

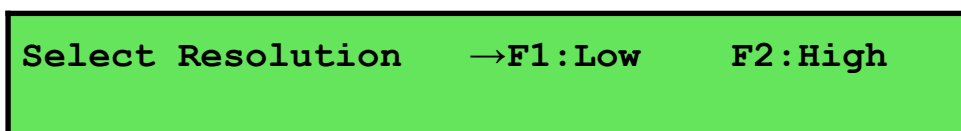
1. Select the Resolution menu ( → **F5:System** → **F5:Setup** → **F2:Resolution**)...



The arrow indicates the current selection.

2. After pressing  or  the **hydroCHEM** confirms the display resolution for both Conductivity/TDS (in currently selected units) and pH. For example...

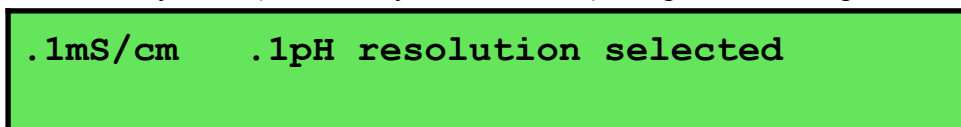

The following table listed the low and high resolutions for the various Conductivity/TDS units and pH...

	Low Resolution	High Resolution
Conductivity mS/cm	0.1	0.01



TDS ppK	0.1	0.01
Conductivity CF units	1	0.1
Conductivity dS/m	0.1	0.01
pH	0.1	0.01



20. Emergency ShutOFF timer



The emergency ShutOFF timer shuts the Conductivity and/or pH pumps down if they have operated continuously for a preset time, without the readings coming back to within the limits. For example, this condition could occur if the sensor is faulty and is giving an incorrect reading or if the added chemicals were not able to be seen by the sensors. The ShutOFF feature provides a safeguard against dosing entire nutrient and/or acid tanks to the crop. To set the ShutOFF time...

1. Select the Setup menu ( → **F5: System** → **F5: Setup**).
2. Select **F3: ShutOFF** from the menu. The **hydroCHEM** now allows you to enter the maximum time for which the Conductivity pump will operate, without getting back to within the limit...



Enter Cond. ShutOFF Timer : 60 minutes



Use the  and  keys to set the required time, from 10 to 240 minutes.



Press and hold the  key at the same time as the  and  keys to scroll keys to scroll rapidly.

3. Press  to save the ShutOFF timer setting for the Conductivity pump.
Press  to quit and retain the current setting.
4. If  was pressed, above, the **hydroCHEM** will now allow you to enter the maximum time for which the pH pump will operate, without getting back to within the limit...

Cond. ShutOFF Timer : 60 minutes
Enter pH ShutOFF Timer : 15 minutes

Use the  and  keys to set the required time, from 5 to 240 minutes.

Press and hold the  key at the same time as the  and  keys to scroll keys to scroll rapidly.

5. Press  to save the ShutOFF timer setting for the pH pump.
Press  to quit and retain the current setting.

20.1 Procedure in event of ShutOFF timer being tripped

When the ShutOFF timer has been tripped, the word "**ShutOFF**" is displayed as the status for the relevant reading and the **hydroCHEM** beeps.

To re-set the ShutOFF timer, press the  key.

No further automatic control will occur for that parameter until the  key is pressed.

The condition that caused the ShutOFF timer to trip must be rectified to avoid it being tripped again. This may involve one or more of the following...

- Re-fill the A Nutrient, B Nutrient, or pH adjustor drum if they were empty.
- Check and re-calibrate the Conductivity and/or pH sensors to ensure the reading is actually correct.



- Extend the ON time if the pump rate is not high enough to keep up with chemical demand for the current ON time.
- Place the chemical addition point as close as practical to the sensors in the main tank. If a **hydroCHEM-DS** with in-built sample chamber is being used, place the pick-up point for the sample chamber as close as possible to the drain from the overflow pipe.

21. Selecting Buffers for Auto Buffer Recognition

The **hydroCHEM** is factory set to automatically recognise pH4.01, pH7.00 and pH9.18 buffers. However, some users may prefer to use pH6.86 instead of pH7.00 and pH10.01 instead of pH9.18. The following procedure describes how to set which of these buffers are automatically recognised at calibration.

1. Select the Setup menu ( → **F5:System** → **F5:Setup**).
2. Select **F4:Buffer** from the menu. The **hydroCHEM** now prompts you to select the Primary Buffer you wish to use for calibration...

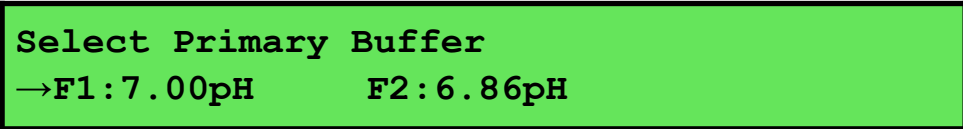

Select Primary Buffer
→F1:7.00pH F2:6.86pH

The arrow indicates the current selection.

Press  to select pH7.00 as the primary buffer.

Press  to select pH6.86 as the primary buffer.

Press  to quit and retain the current buffer settings.

3. If  or  was press above, the **hydroCHEM** will now prompt you to select the Secondary pH Buffers you wish to use for calibration...

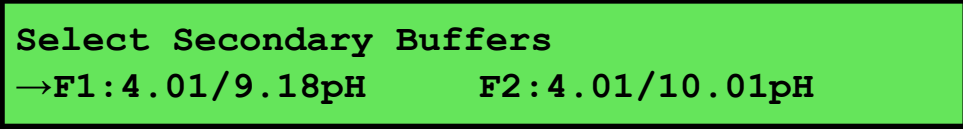

Select Secondary Buffers
→F1:4.01/9.18pH F2:4.01/10.01pH

The arrow indicates the current selection.

Press  to select pH4.01 and pH9.18 as the secondary buffers.

Press  to select pH4.01 and pH10.01 as the secondary buffers.

Press  to quit and retain the current buffer settings.

22. Resetting the hydroCHEM

The calibration information and the full system set-up information can be reset to factory defaults, if required. This allows the operator to set up and calibrate the unit from the beginning, with a clean system.

22.1 Resetting the Calibration information only

1. Select the Reset menu ( → **F5:System** → **F5:Setup** → **:F5:Reset**).
2. Select **F1:Calibration only** from the menu.
3. The following message is now displayed...

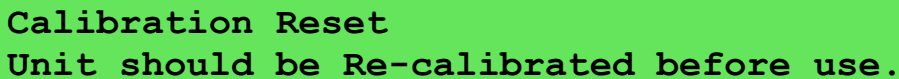

Calibration Reset
Unit should be Re-calibrated before use.

4. The **hydroCHEM** now returns to the Setup menu. Note that the decimal points will be replaced with a “ * ” in normal display mode, to indicate that the unit must be re-calibrated.

22.2 Resetting the Full System information

1. Select the Reset menu ( → **F5:System** → **F5:Setup** → **:F5:Reset**).
2. Select **F2:Full System** from the menu.
3. The following message is now displayed...

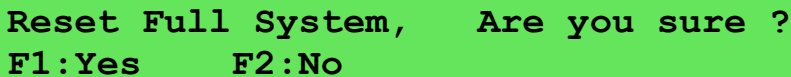

Reset Full System, Are you sure ?
F1:Yes F2:No

Press  to reset all calibration, limit and control settings to factory defaults.

Press  to quit without resetting the system.

5. The following message is displayed when the full system is reset...



System Reset
All Calibration and Control values RESET



22.3 Factory Default System Settings

The factory default calibration and system settings are as follows...

Conductivity

Sensor Zero : 0.00 mS/cm
Sensor Span : 100.0 %
Control Limit : 2.0 mS/cm
Control Direction : Add if Low
Control Sensitivity : Medium
Control ON Time : 15 Minutes
Control OFF Time : 5 Minutes
ShutOFF Timer : 60 Minutes
A Quick-Dose Time: 5 Minutes
B Quick-Dose Time: 5 Minutes
Alarm Margin : 0.30 mS/cm
Alarm Delay Time : 10 minutes

pH

Sensor Asymmetry : 0.00 pH
Sensor Slope : 100.0 %
Primary Buffer : pH7.00 * Not changed by Reset
Secondary Buffers : pH4.01 & pH9.18 * Not changed by Reset
Control Limit : 6.5 pH
Control Direction : Add if High
Control Sensitivity : Medium
Control ON Time : 10 Minutes
Control OFF Time : 5 Minutes
ShutOFF Timer : 20 Minutes
Quick-Dose Time : 5 Minutes
Alarm Margin : 0.30 pH
Alarm Delay Time : 10 minutes

Temperature

Sensor Offset : 0.0 °C

Alarms : Disabled

RS232 Port (when the Plus-Pack is fitted)

RS232 Baud Rate : 9600 Baud

23. Instrument firmware version number

If you need to phone or fax TPS for any further technical assistance, the version number of your **hydroCHEM** firmware may be of benefit to us. The version number is displayed by the **hydroCHEM** at turn-on.

24. Troubleshooting

24.1 General Errors

Error Message	Possible Causes	Remedy
Factory Calibration Data Failure Temperature Readings may be Inaccurate	The EEPROM chip which contains the factory calibration information has failed.	The unit must be returned to TPS for service. <ul style="list-style-type: none"> • Temperature readings may be up to 10% incorrect. • Conductivity/TDS readings will be accurate after 2 point calibration.
EEPROM Write Failure Return to Factory for Service	User calibration settings have been lost or corrupted.	Switch the meter OFF and switch back ON. If the problem persists, return the unit to TPS for service.
Logged Data pointer failure All Logged Data Lost	<ol style="list-style-type: none"> 1. Memory back-up battery has lost its charge due to lack of use of the instrument. 2. Memory back-up battery is faulty. 	Recharge the memory back-up battery by switching the meter on for approx. 16 hours (this does not need to be continuous). Return the instrument to the factory to have a new rechargeable battery fitted.
"NoFlo" message does not appear, even when the Conductivity sensor is dry and in air (hydroCHEM-DS unit which uses Conductivity reading for flow sensing.)	<ol style="list-style-type: none"> 1. Conductivity sensor has a build-up of salts or algae between wires. 2. Conductivity sensor is faulty. 	Clean probe as per section 25.2.2. Return sensor to factory for repair or replacement.
"NoFlo" message appears even when the Conductivity sensor is in solution. (hydroCHEM-DS unit which uses Conductivity reading for flow sensing.)	<ol style="list-style-type: none"> 1. Conductivity of solution is below 0.5 mS/cm (0.2 ppK TDS). 2. Conductivity sensor is faulty. 	The flow sensing function only operates if the Conductivity is above 0.5 mS/cm (0.2 ppK TDS). If a fresh batch of water is being used, use the Quick-Dose function (section 4) to raise the Conductivity to above 0.5 mS/cm. An optional pump detector is available to solve this problem automatically. Please contact the factory or your distributor. Return sensor to factory for repair or replacement.
"NoFlo" message does not appear, even when the main pump is OFF. (Standard hydroCHEM unit which uses pump sensor for flow sensing.)	Pump sensor is faulty.	Return sensor to factory for repair or replacement.
"NoFlo" message appears even when the main pump is operating. (Standard hydroCHEM unit which uses pump sensor for flow sensing.)	<ol style="list-style-type: none"> 3. Pump sensor not mounted in optimum position on main pump housing. 4. Pump sensor is faulty. 	Try mounting the sensor in alternative positions on the pump. The best position is close to the pump motor. Return sensor to factory for repair or replacement.

24.2 Conductivity / TDS Troubleshooting

Symptom	Possible Causes	Remedy
Unit fails to calibrate, even with new probe.	Calibration settings outside of allowable limits due to previous failed calibration.	Reset the unit. See section 22.
Unit attempts Span calibration instead of Zero calibration.	Sensor has Zero error.	Thoroughly rinse sensor in distilled water and allow to completely dry in air before attempting zero calibration. If instrument does not calibrate at Zero with sensor disconnected, then the instrument is faulty.
Standard calibration fails, and span is less than 75%.	<p>1. Sensor is not immersed correctly.</p> <p>733069216. Sensor may have a build-up of dirt or oily material on electrode wires.</p> <p>733069217. Standard solution is inaccurate.</p> <p>733069218. Sensor is faulty.</p> <p>733069219. Faulty instrument.</p>	<p>Immerse sensor correctly, at least to the top of the large vent hole, as per diagram in section 7.1.</p> <p>Clean sensor, as per the instructions detailed in section 25.2.2.</p> <p>Replace standard solution.</p> <p>Return sensor to factory for repair or replacement.</p> <p>Return to factory for repair.</p>
Standard calibration fails, and span is greater than 133%.	<p>733069272. Standard solution is inaccurate.</p> <p>733069273. Sensor may have a build-up of conductive material, such as salt.</p> <p>733069274. Sensor is faulty.</p> <p>733069275. Faulty instrument.</p>	<p>Replace standard solution.</p> <p>Clean sensor, as per the instructions detailed in section 25.2.2.</p> <p>Return sensor to factory for repair or replacement.</p> <p>Return to factory for repair.</p>
Inaccurate readings, even when calibration is successful.	1. Sensor may have a build-up of dirt or oily material on electrode wires.	Clean sensor, as per the instructions detailed in section 25.2.2.
Readings drift.	1. Sensor may have a build-up of dirt or oily material on electrode wires.	Clean sensor, as per the instructions detailed in section 25.2.2.
Readings are low or near zero.	<p>1. Sensor may have a build-up of dirt or oily material on electrode wires.</p> <p>733069104. Sensor is not immersed correctly.</p> <p>733069105. Sensor is faulty.</p> <p>733069106. Faulty instrument.</p>	<p>Clean sensor, as per the instructions detailed in section 25.2.2.</p> <p>Immerse sensor correctly, at least to the top of the large vent hole, as per diagram in section 7.1.</p> <p>Return sensor to factory for repair or replacement.</p> <p>Return to factory for repair.</p>

24.3 pH Troubleshooting

Symptom	Possible Causes	Remedy
Unit fails to calibrate, even with new probe.	Calibration settings outside of allowable limits due to previous failed calibration.	Reset the unit. See section 22.
1 Point calibration fails (Asymmetry is greater than +/-1.00 pH).	1. Reference junction blocked.	Clean reference junction, as per instructions supplied with the electrode.
2 Point calibration fails (Slope is less than 85.0%).	1. Buffer set incorrectly 733068712. Glass bulb not clean. 733068713. Electrode is aged. 733068714. Connector is damp. 733068715. Buffers are inaccurate.	For automatic buffer recognition, ensure that you are using buffers that match the selected buffer set (section 21). Clean glass bulb as per instructions supplied with the electrode. Attempt rejuvenation, as per instructions supplied with the electrode. If not successful, replace electrode. Dry in a warm place. Replace buffers.
Unstable readings.	733069048. Reference junction blocked. 733069049. Glass bulb not clean. 733069050. Bubble in glass bulb. 733069051. Faulty connection to meter. 733069052. Reference junction not immersed.	Clean reference junction, as per instructions supplied with the electrode. Clean glass bulb as per instructions supplied with the electrode. Flick the electrode to remove bubble. Check connectors. Replace if necessary. Ensure that the bulb AND the reference junction are fully immersed, as per diagram in section 9.1.
Inaccurate readings, even when calibration is successful.	Reference junction blocked.	Clean reference junction, as per instructions supplied with the electrode.
Displays 7.00 for all solutions.	Electrical short in connector.	1. Check connector. Replace if necessary. 733068880. Replace electrode.
Displays 4-5 pH for all solutions.	Glass bulb or internal stem cracked.	Replace electrode.

24.4 Temperature Troubleshooting

Symptom	Possible Causes	Remedy
Temperature inaccurate and cannot be calibrated.	1. Faulty connector. 733068656. Faulty temperature sensor (inside Conductivity sensor).	Check the connector and replace if necessary. Fit new Conductivity/Temperature sensor.
Displays flashing “OVR ^o c” when temperature probe plugged in.	1. Faulty Cond/Temp socket. 2. Faulty temperature sensor (inside Conductivity sensor).	Return the instrument to the TPS factory for service. Fit new Conductivity/Temperature.

24.5 Pump Troubleshooting

Symptom	Possible Causes	Remedy
Pump(s) do not prime, lose their prime, or pumping at a very low flow rate.	1. Input tube incorrectly fitted, causing air leak. 2. Worn pump squeeze tube. 3. Faulty pump.	See section 11.1 for details on correct input tube fitment. Fit replacement pump tube (part no 116352). See details in section 11.4. Return to the TPS factory for repair.



A & B pumps do not produce the same output	Output flow rate of each pump is different.	Adjust A & B Fine Tune control until a 1:1 A & B ratio is achieved. See section 11.1.
Display shows “ ShutOFF ” for Conductivity and/or pH control status.	<ol style="list-style-type: none"> 1. Control ON time set too short and/or OFF time set too long. 2. Pump(s) have insufficient capacity to keep up with demand. 	<p>See section 20 for details on ShutOFF function and suggested remedies.</p> <p>Alternative higher capacity pump(s) are required.</p>
Not Dosing. “ PumpFault ” Error message displayed.	Excess Dosing pump or Control Output current detected	<p>Press Menu to reset error. If error re-occurs dosing pump/s will require service.</p> <p>Control outputs must not exceed 160mA.</p>

25. Appendices

25.1 Mounting the hydroCHEM

25.1.1 Mounting the hydroCHEM unit...

The **hydroCHEM** unit is pre-installed onto a convenient mounting panel. 6mm diameter holes are located in each corner for mounting the panel. Use fasteners that are suitable for material to which the panel is being mounted. The fasteners should be rated to at least 0.5kg each.

25.1.2 Mounting the hydroCHEM Dosing System panel...

The **hydroCHEM** Dosing System is supplied with a second mounting panel which is fitted with the pump box and sample chamber. 6mm diameter holes are located in each corner for mounting the panel. Use fasteners that are suitable for material to which the panel is being mounted. The fasteners should be rated to at least 1.5kg each.

25.2 Care and Cleaning of Conductivity Sensors

25.2.1 Care of Conductivity sensors

The conductivity section of the sensor supplied with your **hydroCHEM** consists of four platinum wires wound around a central stem. The stainless steel tip is purely for temperature measurement.

Although the four wire system is extremely resistant to fouling, avoid contact with oily materials and excessive algae build-up. If a coating is allowed to form on the surface of the wires, accuracy will be reduced.

Conductivity sensors can be stored dry. Ensure that the sensor is stored in a covered container to avoid dust and dirt build-up.

25.2.2 Cleaning of Conductivity of Sensors.

Four wire Conductivity sensors can be cleaned by wiping the wires with a clean, soft cloth. Methylated Spirits or detergents may be used on the cloth to remove any build-up.

Stubborn contamination can be removed by soaking the sensor in a solution of 1 part Concentrated HCl and 10 parts distilled water. Approximately 5 minutes soaking should remove most build-ups. Avoid prolonged exposure to the acid, as the stainless steel tip may deteriorate.

If these methods fail, then the last resort is to physically scrub the electrode wires to remove the contaminant. Use only a cloth or nylon scouring pad. **DO NOT USE STEEL WOOL.**

25.3 pH Electrode Fundamentals

A combination pH Electrode is two electrodes in one. The sensing membrane is the round or spear shaped bulb at the tip of the electrode. This produces a voltage that changes with the pH of the solution. This voltage is measured with respect to the second part of the electrode, the reference section. The reference section makes contact with the sample solution using a salt bridge, which is referred to as the reference junction. A saturated solution of KCl is used to make contact with the sample. It is vital that the KCl solution has an adequate flow rate in order to obtain stable and accurate pH measurements.

25.3.1 Asymmetry of a pH Electrode

An “ideal” pH electrode produces 0 mV output at 7.00 pH. In practice, pH electrodes generally produce 0 mV output at slightly above or below 7.00 pH. The amount of variance from 7.00 pH is called the asymmetry. Figure 251 illustrates how asymmetry is expressed.

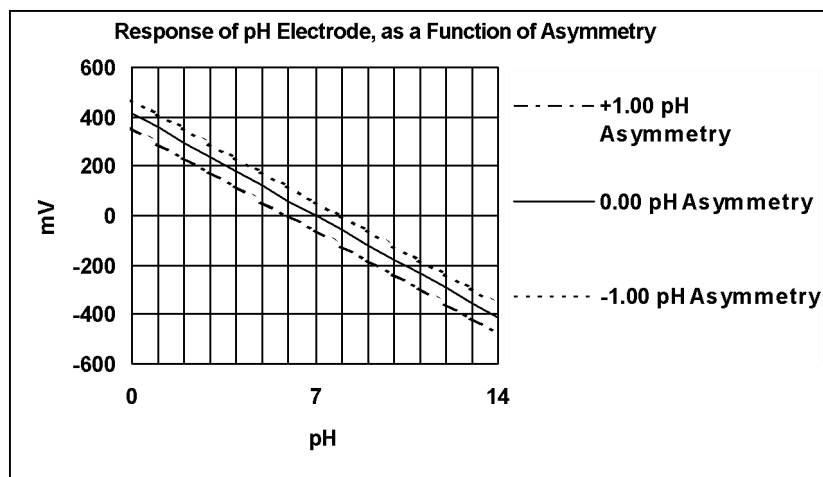

Figure 251

25.3.2 Slope of a pH Electrode

As mentioned above, a pH electrode produces 0 mV output at around 7.00 pH. As the pH goes up, an “ideal” pH electrode produces -59mV/pH unit at 25 °C. As the pH goes down, an ideal pH electrode produces +59mV/pH unit. In practice, pH electrodes usually produce slightly less than this. The output of a pH electrode is expressed as a percentage of an ideal electrode. For example, an ideal electrode that produces 59mV/pH unit has “100% Slope”. An electrode that produces 50.15mV/pH unit has “85% Slope” (see Figure 252).

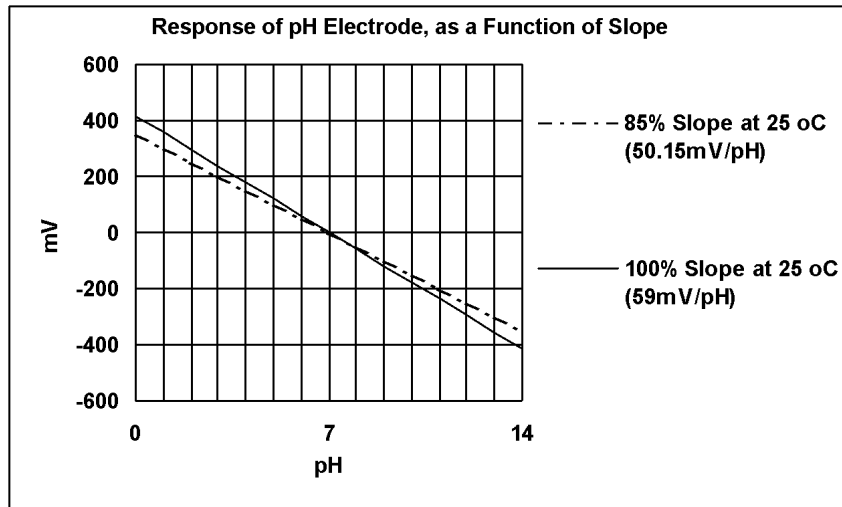

Figure 252

25.3.3 Temperature Compensation

The slope of a pH electrode is affected by temperature. This effect is compensated for either by using an Automatic Temperature Compensation (ATC) probe or by entering the sample temperature manually. Figure 253 shows the slope of a pH electrode at various temperatures.

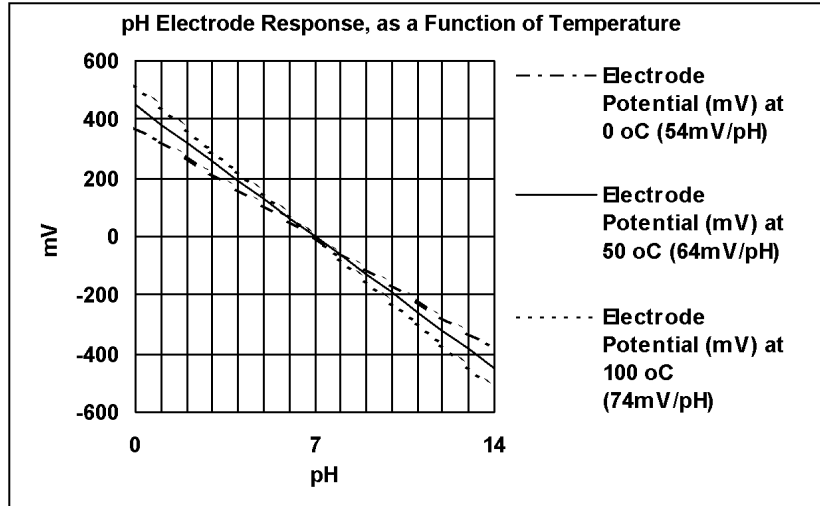

Figure 253



25.4 hydroCHEM Specifications

	Standard Unit		With optional Plus-Pack fitted		Accuracy
	Range	Resolution	Range	Resolution	
pH	2.0 to 12.0 pH	0.1 pH	2.00 to 12.00 pH	0.1 & 0.01 pH	±0.01 pH
Conductivity	0 to 9.9 mS/cm	0.1 mS/cm	0 to 9.99 mS/cm	0.1 & 0.01 mS/cm	±0.5%
	0 to 99 CF Unit	1 CF Unit	0 to 99.9 CF Units	1 & 0.1 CF Units	±0.5%
	0 to 9.9 dS/m	0.1 dS/m	0 to 9.99 dS/m	0.1 & 0.01 dS/m	±0.5%
TDS	0 to 9.9 ppK	0.1 ppK	0 to 9.99 ppK	0.01 ppK	±1.0%
Temperature	-10.0 to 120.0 °C	0.1 °C	-10.0 to 120.0 °C	0.1 °C	±0.2 °C

Calibration

Automatic Calibration for all parameters, within the following limits...

Conductivity Zero Range : 0 to 0.2 mS/cm, 0 to 2 CF Units or 0 to 0.2 dS/m, depending on which mode is selected.

Conductivity Span Range : 75 to 133 %

Conductivity Standards : Automatic recognition of 2.76mS/cm or 1.41 mS/cm standard

TDS Zero Range : 0 to 0.1 ppK

TDS Span Range : 75 to 133 %

TDS Standard : Automatic recognition of 2.0 ppK standard

pH Asymmetry Range : -1.00 to +1.00 pH

pH Slope Range : 85.0 to 105 %

pH Buffers : Automatic recognition of pH4.01, pH6.86, pH7.00, pH9.18 and pH10.01 buffers. See section 21 for details on selecting buffers.

Temperature Offset Range : -10.0 °C to +10.0 °C

Control Set-up

		pH	Conductivity	TDS	
Standard Unit	Limit Range	0 to 14.0 pH	0 to 9.9 mS/cm	0 to 9.9 ppK	
	Sensitivity	Fine	0.1 pH	0.1 mS/cm	0.05 ppK
		Medium	0.2 pH	0.2 mS/cm	0.1 ppK
		Coarse	0.3 pH	0.3 mS/cm	0.15 ppK
With optional Plus-Pack fitted	Limit Range	0 to 14.00 pH	0 to 9.99 mS/cm	0 to 9.99 ppK	
	Sensitivity	Fine	0.10 pH	0.10 mS/cm	0.05 ppK
		Medium	0.20 pH	0.20 mS/cm	0.10 ppK
		Coarse	0.30 pH	0.30 mS/cm	0.15 ppK
Dosing ON Timer Range	Note: Enter 0 minutes to take pump off line	0 to 30 minutes	0 to 30 minutes	0 to 30 minutes	
Dosing OFF Timer range	Note: Enter 0 minutes for untimed control (ie. add on demand)	0 to 30 minutes	0 to 30 minutes	0 to 30 minutes	
ShutOFF Timer Range		5 to 240 minutes	10 to 240 minutes	10 to 240 minutes	



Quick-Dose Timer Range		0 to 10 minutes	0 to 10 minutes	0 to 10 minutes
---------------------------	--	-----------------	-----------------	-----------------



Good Laboratory Practices

- All calibration information and user-adjustable set-up information is stored in memory, and can be recalled on the display at any time. This information can also be printed or downloaded to a computer, when the optional Plus Pack is fitted.
- The unit's serial number is stored in memory. This is displayed at turn-on, and included with GLP information.

Plus Pack Option

The Plus Pack option includes the following items...

- RS232 Serial Interface for printing or downloading data.
- Datalogging capability.
- 24 Hour Calendar Clock.
- Selectable High or Low resolution.

Datalogging

This section is applicable when the optional Plus-Pack is fitted.

Memory	: 2300 readings, including date and time.
Automatic Datalogging	: User selectable for one reading every... 1, 2, 5, 10, 15, 20 or 30 minutes, or every... 1, 2, 3, 4, 6, 8, 12 or 24 hours.

RS232 Serial Interface

This section is applicable when the optional Plus-Pack is fitted.

Port Configuration	: 8 Bits, No Parity, 1 Stop Bit, XON/XOFF Protocol.
Baud Rates	: User selectable for 300, 9600 or 19200 Baud.

Calendar Clock

This section is applicable when the optional Plus-Pack is fitted.

- 24 Hour Calendar Clock.
- Tests for valid day of the month when setting (eg. 31/09/10 is not valid).
- Adjusts for leap years.
- The microprocessor in the **hydroCHEM** stores the year to 2 digits. However, all data sent to the RS232 port is converted to 4 digits, so there are no Year 2000 problems.

Peristaltic Pumps

*This section is applicable to the **hydroCHEM-DS**...*

- 3 x 5 Litre / Hour Peristaltic Pumps built into a single pump box.
- Chemical resistant Santoprene pump tubing.



26. Warranty

TPS Pty. Ltd. guarantees all instruments and sensors to be free from defects in material and workmanship when subjected to normal use and service. This guarantee is expressly limited to the servicing and/or adjustment of an instrument returned to the Factory, or Authorised Service Station, freight prepaid, within twelve (12) months from the date of delivery, and to the repairing, replacing, or adjusting of parts which upon inspection are found to be defective. Warranty period on sensors is three (3) months.

There are no express or implied warranties which extend beyond the face hereof, and TPS Pty. Ltd. is not liable for any incidental or consequential damages arising from the use or misuse of this equipment, or from interpretation of information derived from the equipment.

Shipping damage is not covered by this warranty.

PLEASE NOTE

A guarantee card is packed with the instrument or sensor. This card must be completed at the time of purchase and the registration section returned to TPS Pty. Ltd. within 7 days. No claims will be recognised without the original guarantee card or other proof of purchase. This warranty becomes invalid if modifications or repairs are attempted by unauthorised persons, or the serial number is missing.

PROCEDURE FOR SERVICE

If you feel that this equipment is in need of repair, please re-read the manual. Sometimes, instruments are received for "repair" in perfect working order. This can occur where the sensor(s) simply requires cleaning or replacement or some other field serviceable event.

TPS Pty. Ltd. has a fine reputation for prompt and efficient service. In just a few days, our factory service engineers and technicians will examine and repair your equipment to your full satisfaction.

To obtain this service, please follow this procedure...

Return the instrument AND ALL SENSORS to TPS freight pre-paid and insured in its original packing or suitable equivalent. INSIST on a proof of delivery receipt from the carrier for your protection in the case of shipping claims for transit loss or damage. It is your responsibility as the sender to ensure that TPS receives the unit.

Please check that the following is enclosed with your equipment:

- **Your Name and daytime phone number.**
- **Your company name, ORDER number, and return street address.**
- **A description of the fault. (Please be SPECIFIC.)**
(Note: "Please Repair" does NOT describe a fault.)

Your equipment will be repaired and returned to you by air express where possible.

For out-of-warranty units, a repair cost will be calculated from parts and labour costs. If payment is not received for the additional charges within 30 days, or if you decline to have the equipment repaired, the complete unit will be returned to you freight paid, not repaired. For full-account customers, the repair charges will be debited to your account.